

Enclosed Phone Jack

multicomp PRO

**RoHS
Compliant**

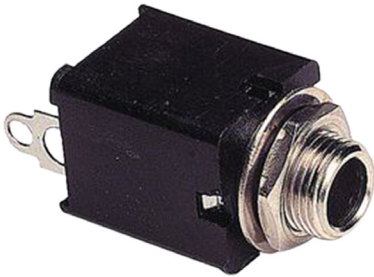

Specifications:

Electrical

Contact Rating : 0.25A at 48V DC
 Contact Resistance : 20mΩ Max. initial, 50m Max. after Life
 Insulation Resistance : 50,000MΩ Min. at 500V DC
 Dielectric Strength : 500V AC for one minute

Mechanical

Insertion Force : 0.5kg to 3kg
 Withdrawal Force : 0.5kg to 3kg
 Operating Life : 10,000 cycles

Environmental

Operating Temperature : -40°C to 80°C

Diagram

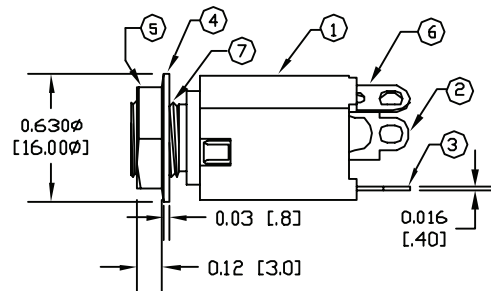
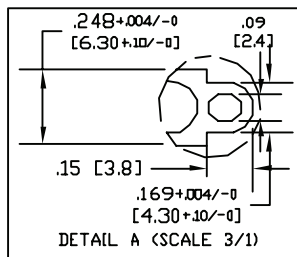
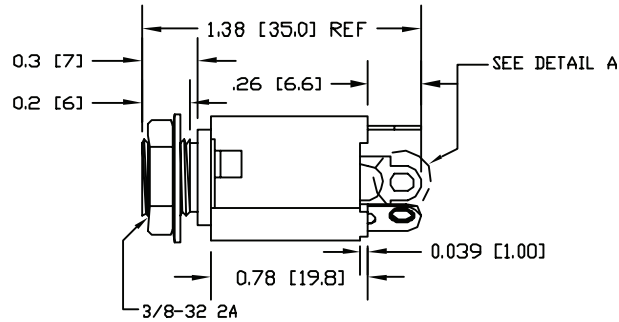
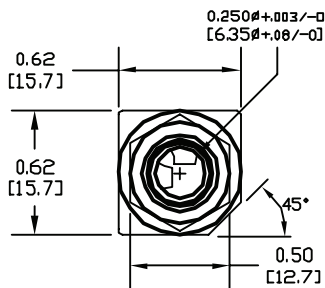

Dimensions : Inches (Millimetres)

Item	Description	Material/Finish
1	Housing	ABS
2	Ring Spring	Bronze – Tin Plated
3	Tip Spring	Bronze – Tin Plated
4	Washer	Brass – Nickel Plated
5	Hex Nut	Brass – Nickel Plated
6	Sleeve Terminal	Brass – Tin Plated
7	Bushing	Brass – Nickel Plated

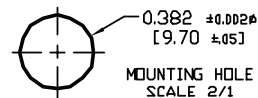

Newark.com/multicomp-pro
 Farnell.com/multicomp-pro
 Element14.com/multicomp-pro

multicomp PRO

Enclosed Phone Jack

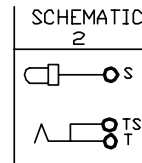
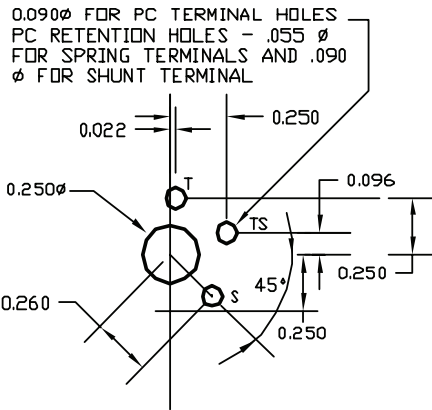

UNLESS OTHERWISE SPECIFIED TOL= ± 0.004
 PCB LAYOUT-BOTTOM VIEW (SCALE 2/1)

Part Number Table

Description	Part Number
Enclosed Phone Jack	SPC24111

Important Notice : This data sheet and its contents (the "Information") belong to the members of the AVNET group of companies (the "Group") or are licensed to it. No licence is granted for the use of it other than for information purposes in connection with the products to which it relates. No licence of any intellectual property rights is granted. The Information is subject to change without notice and replaces all data sheets previously supplied. The Information supplied is believed to be accurate but the Group assumes no responsibility for its accuracy or completeness, any error in or omission from it or for any use made of it. Users of this data sheet should check for themselves the Information and the suitability of the products for their purpose and not make any assumptions based on information included or omitted. Liability for loss or damage resulting from any reliance on the Information or use of it (including liability resulting from negligence or where the Group was aware of the possibility of such loss or damage arising) is excluded. This will not operate to limit or restrict the Group's liability for death or personal injury resulting from its negligence. Multicomp Pro is the registered trademark of Premier Farnell Limited 2019.