



DESCRIPTION

The MPQ7220 is a boost converter with six channel current sources. It is designed for driving automotive tail lights.

The MPQ7220 uses peak current mode as its PWM control architecture. The switching frequency can be programmed by a resistor. It independently regulates the current in each LED string to the value set by an external current-setting resistor.

The device applies six internal current sources, one in each LED string terminal to achieve a current balance with 2.5% current regulation accuracy between strings. The low headroom voltage for LED regulation and on resistance of switching MOSFETs allows for high efficiency.

The MPQ7220 has rich protection modes to guarantee safe operation. Protection modes include OCP (over-current protection), OVP (over-voltage protection), OTP (over-temperature protection), and LED string short and open protection. The LED current decreases at high temperatures.

The MPQ7220 is available in QFN-24 (4mmx4mm) and TSSOP28-EP packages.

FEATURES

- 3.5V to 36V Input Voltage Range
- Six Channels with Max 100mA per Channel
- Internal 100m Ω , 50V MOSFET
- Programmable Up to 2.2MHz f_{sw}
- External Sync SW Function
- PWM Dimming (Dimming Frequency from 100Hz to 20kHz)
- Excellent EMI Performance, Spread Spectrum
- Disconnect V_{OUT} from V_{IN}
- 2.5% Current Matching
- Cycle-by-Cycle Current Limiting
- Programmable LED Short Threshold
- Programmable OVP Threshold
- LED Current Auto-Decrement at High Temperatures
- LED Short/Open, OTP, OCP, Inductor Short Protection
- Fault Indicator Signal Output
- Available in QFN-24 (4mmx4mm) and TSSOP28-EP Packages
- AEC-Q100 Grade 1

APPLICATIONS

- Automotive Tail Lights

All MPS parts are lead-free, halogen-free, and adhere to the RoHS directive. For MPS green status, please visit the MPS website under Quality Assurance. "MPS", the MPS logo, and "Simple, Easy Solutions" are trademarks of Monolithic Power Systems, Inc. or its subsidiaries.

TYPICAL APPLICATION

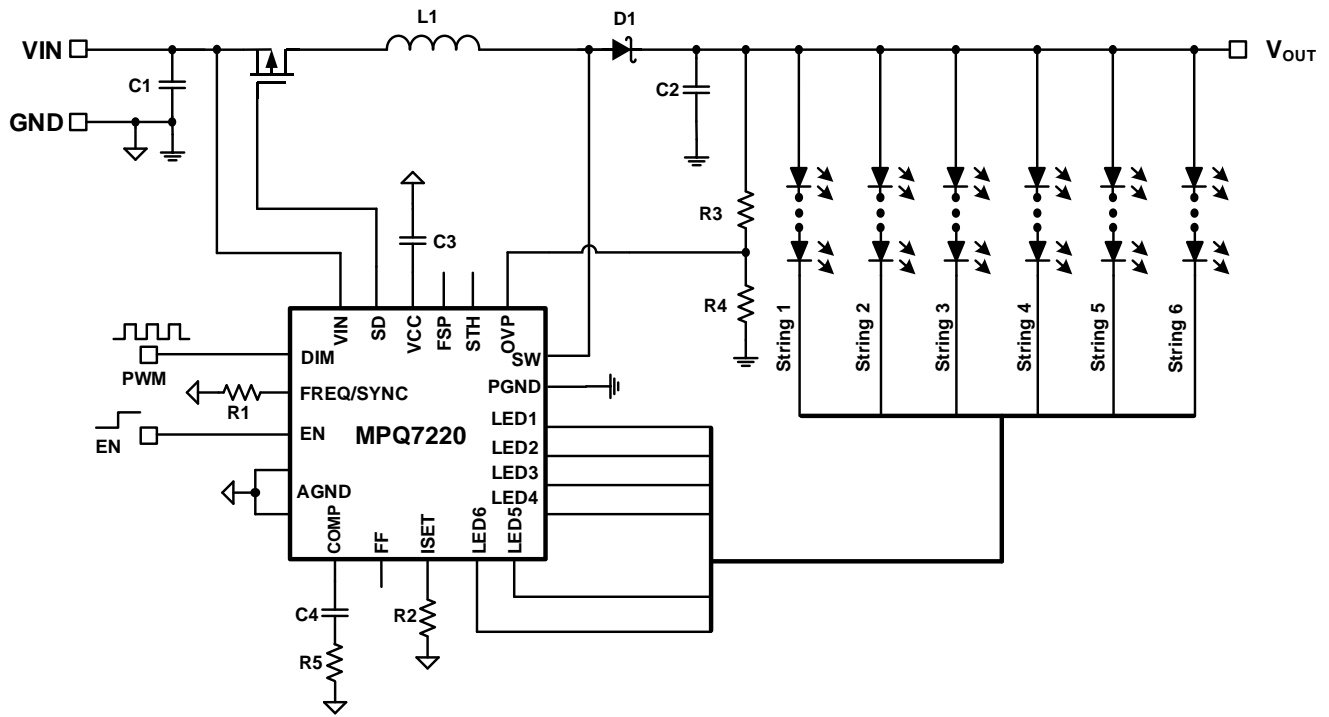

ORDERING INFORMATION

Part Number*	Package	Top Marking	MSL Rating**
MPQ7220GR-AEC1	QFN-24 (4mmx4mm)	See Below	Level 1
MPQ7220GF-AEC1***	TSSOP28-EP	See Below	Level 2a

* For Tape & Reel, add suffix –Z (e.g. MPQ7220GR-AEC1-Z).

** Moisture Sensitivity Level Rating.

*** For Tape & Reel, add suffix –Z (e.g. MPQ7220GF-AEC1-Z), under qualification.

TOP MARKING (MPQ7220GF-AEC1)

MPSYYWW
MP7220
LLLLLLLLLL

MPS: MPS prefix
YY: Year code
WW: Week code
MP7220: Part number
LLLLLLLLLL: Lot number

TOP MARKING (MPQ7220GR-AEC1)

MPSYWW
MP7220
LLLLLL

MPS: MPS prefix
Y: Year code
WW: Week code
MP7220: Part number
LLLLLL: Lot number

PACKAGE REFERENCE

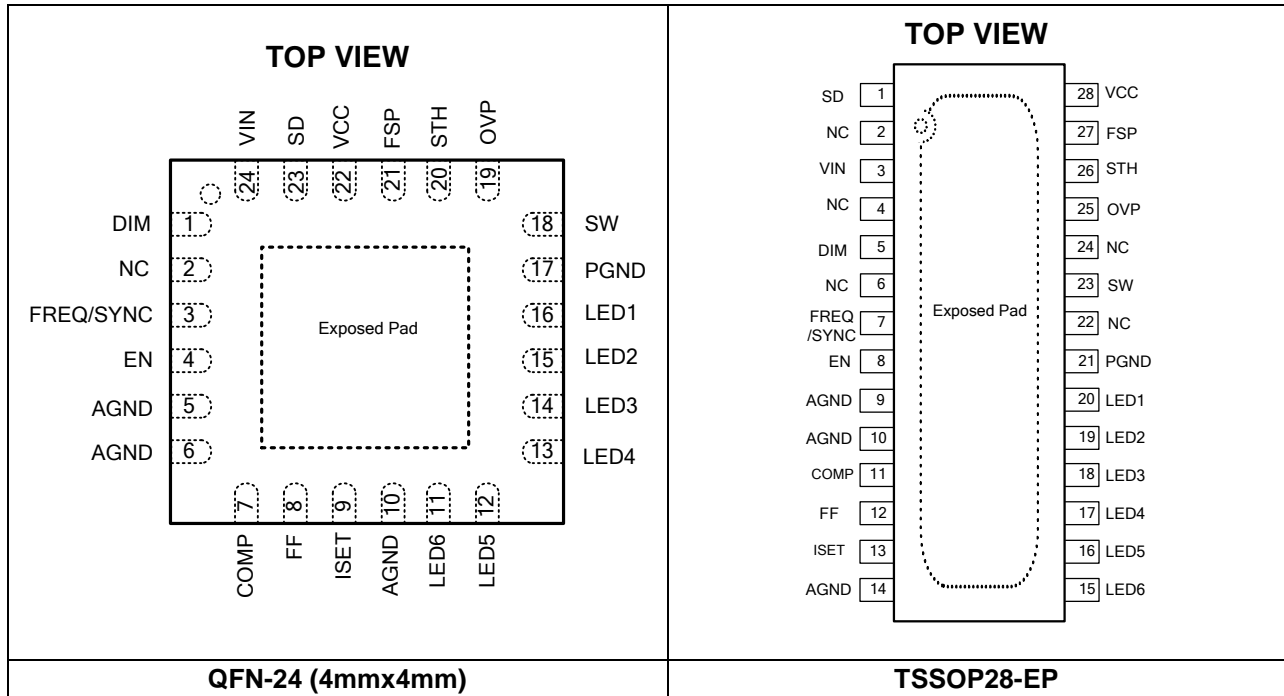

PIN FUNCTIONS

QFN24 Pin #	TSSOP28-EP Pin #	Name	Description
1	5	DIM	DIM signal input. Apply a PWM signal on DIM for brightness control. Pulled low internally. A 100Hz to 20kHz PWM signal is recommended. Pull this pin high if the dimming function not used.
2	2, 4, 6, 22, 24	NC	Not connected.
3	7	FREQ/SYNC	Switching frequency setting and SYNC pin. Connect a resistor between this pin and GND to set the converter's switching frequency. Or connect an external clock to sync the boost switching frequency.
4	8	EN	IC enable pin. Pull this pin to high enable the IC. Pull this pin low to force the IC to enter shutdown mode.
7	11	COMP	Compensation pin.
8	12	FF	Fault flag pin. Open drain during normal operation, pulled low in any fault mode. Float FF if not used.
9	13	ISET	LED current setting. Tie a current-setting resistor from this pin to ground to program the current in each LED string.
5, 6, 10	9, 10, 14	AGND	Analog ground.
11	15	LED6	LED string 6 current input. Connect the LED string 6 cathode to this pin.
12	16	LED5	LED string 5 current input. Connect the LED string 5 cathode to this pin.
13	17	LED4	LED string 4 current input. Connect the LED string 4 cathode to this pin.
14	18	LED3	LED string 3 current input. Connect the LED string 3 cathode to this pin.
15	19	LED2	LED string 2 current input. Connect the LED string 2 cathode to this pin.

PIN FUNCTIONS *(continued)*

QFN24 Pin #	TSSOP28-EP Pin #	Name	Description
16	20	LED1	LED string 1 current input. Connect the LED string 1 cathode to this pin.
17	21	PGND	Step-up converter power ground.
18	23	SW	Drain for the internal low-side MOSFET switch. Connect the power inductor to SW.
19	25	OVP	Over-voltage protection pin. Use a voltage divider to program the OVP threshold (see the Application Information section on page 20). Do not float this pin.
20	26	STH	Short LED protection threshold set pin. An 18 μ A current source flows out of this pin. Connect a resistor from STH to GND to set the protection threshold. The short protection threshold is 5V if this pin is floated.
21	27	FSP	Switching frequency spread spectrum pin. An 18 μ A current source flows out of this pin. Connect a resistor from FSP to GND to set the voltage. If FSP < 0.4V, the jitter frequency is 1/20 of the central frequency. If FSP = 0.45V to 1.4V, the jitter frequency is 1/32 of the central frequency. If FSP > 1.4V or is floated, the frequency spread spectrum is disabled.
22	28	VCC	5V LDO output pin. VCC provides power for the internal logic and gate driver. Place a ceramic capacitor as close as possible to this pin to reduce noise.
23	1	SD	External disconnect PMOS gate drive pin. Turn off the external PMOS in a fault condition. Float this pin if not used.
24	3	VIN	Power supply input. VIN supplies the power to the IC.
Exposed pad	Exposed pad	Exposed pad	Exposed pad. It has no internal electrical connection to AGND and PGND. Connect exposed pad to external GND plane on board for optimal thermal performance.

ABSOLUTE MAXIMUM RATINGS ⁽¹⁾

V_{IN}	-0.3V to +42V
V_{SW} , V_{LED1} to V_{LED6}	-0.5V to +50V
V_{SD}	$V_{IN} - 6V$ to V_{IN}
All other pins.....	-0.3V to +6.5V
Junction temperature	150°C
Lead temperature	260°C
Storage temperature.....	-65°C to +150°C
Continuous power dissipation ($T_A = 25^\circ\text{C}$) ⁽²⁾	
QFN-24 (4mmx4mm)	2.97W
TSSOP28-EP	3.9W

Electrostatic Discharge (ESD)

HBM (human body model)	
LED1-6	$\pm 7\text{kV}$
All other pins	$\pm 2\text{kV}$
CDM (charged device model)	$\pm 750\text{V}$

Recommended Operating Conditions

Supply voltage (V_{IN})	3.5V to 36V
Operating junction temp (T_J)	-40°C to +125°C ⁽³⁾

Thermal Resistance	θ_{JA}	θ_{JC}
QFN-24 (4mmx4mm)		
JESD51-7 ⁽⁴⁾	42	9.....°C/W
EVQ7220-R-00A ⁽⁵⁾	47	8.....°C/W
TSSOP28-EP		
JESD51-7 ⁽⁴⁾	32	6.....°C/W
EVQ7220-F-00A ⁽⁵⁾	44	7.....°C/W

Notes:

- 1) Exceeding these ratings may damage the device.
- 2) The maximum allowable power dissipation is a function of the maximum junction temperature T_J (MAX), the junction-to-ambient thermal resistance θ_{JA} , and the ambient temperature T_A . The maximum allowable continuous power dissipation at any ambient temperature is calculated by P_D (MAX) = $(T_J$ (MAX) - T_A) / θ_{JA} . Exceeding the maximum allowable power dissipation will cause excessive die temperature, and the regulator will go into thermal shutdown. Internal thermal shutdown circuitry protects the device from permanent damage.
- 3) Operation devices at junction temperature up to 150°C is possible; contact MPS for details.
- 4) Measured on JESD51-7, 4-layer PCB.
- 5) Measured on MPS standard EVB of MPQ7220, 2-layer, 1oz. PCB.

ELECTRICAL CHARACTERISTICS

$V_{IN} = 12V$, $V_{EN} = 2V$, $T_J = -40^{\circ}C$ to $+125^{\circ}C$, typical values at $T_J = 25^{\circ}C$, unless otherwise noted.

Parameter	Symbol	Condition	Min	Typ	Max	Units
Operating input voltage	V_{IN}		3.5		36	V
Supply current (quiescent)	I_Q	No switching		5		mA
Supply current (shutdown)	I_{ST}	$V_{EN} = 0V$, $V_{IN} = 12V$			1	μA
Input UVLO threshold	V_{IN_UVLO}	Rising edge		3.1		V
Input UVLO hysteresis				100		mV
LDO output voltage	V_{CC}	$V_{EN} = 2V$, $6V < V_{IN} < 24V$, $0 < I_{VCC} < 10mA$		5		V
EN on threshold	V_{EN_ON}	V_{EN} rising	1.2			V
EN off threshold	V_{EN_OFF}	V_{EN} falling			0.4	V
EN pull-down resistance	R_{EN}			1		$M\Omega$
Step-Up Converter						
Low-side MOS on resistance	R_{DS_LS}	$V_{IN} = 3.7V$		100		m Ω
SW leakage current	I_{SW_LK}	$V_{SW} = 45V$			1	μA
Switching frequency	f_{SW}	$R_{FREQ} = 10k\Omega$	-10%	2.2	+10%	MHz
		$R_{FREQ} = 46.8k\Omega$	-10%	470	+10%	kHz
		FREQ float	-20%	400	+20%	kHz
FREQ voltage	V_{FREQ}		-5%	0.6	+5%	V
FSP pull-up current	I_{FSP}			18		μA
Maximum duty cycle	D_{MAX}	$f_{SW} = 1MHz$	90			%
Cycle-by-cycle current limit	I_{SW_LIMIT}	Duty = 90%	2.3	4		A
Current limit protection	I_{CL}	To trigger current limit protection		8		A
SYNC input low threshold	V_{SYNC_LO}	V_{SYNC} falling			0.4	V
SYNC input high threshold	V_{SYNC_HI}	V_{SYNC} rising	1.2			V
COMP trans-conductance	G_{COMP}	$\Delta I_{COMP} \leq 10\mu A$		100		$\mu A/V$
COMP source current limit	I_{COMP_SO}			90		μA
COMP sink current limit	I_{COMP_SI}			30		μA
Current Dimming						
DIM input low threshold	V_{DIM_LO}	V_{DIM} falling			0.4	V
DIM input high threshold	V_{DIM_HI}	V_{DIM} rising	1.2			V

ELECTRICAL CHARACTERISTICS (continued)
 $V_{IN} = 12V$, $V_{EN} = 2V$, $T_J = -40^{\circ}C$ to $+125^{\circ}C$, typical values at $T_J = 25^{\circ}C$, unless otherwise noted.

Parameter	Symbol	Condition	Min	Typ	Max	Units
Led Current Regulator						
LEDX regulation voltage	V_{HD}	$I_{LED} = 20mA$		300		mV
		$I_{LED} = 100mA$	700	850	1000	mV
Current matching ⁽⁶⁾		$I_{LED} = 20mA$	-2.5		+2.5	%
		$I_{LED} = 100mA$	-2.5		+2.5	%
ISET voltage	V_{ISET}			1.2		V
LED current	I_{LED}	$R_{ISET} = 24.9k\Omega$, $T_J = 25^{\circ}C$	-2.5%	50	+2.5%	mA
		$R_{ISET} = 24.9k\Omega$, $T_J = -40^{\circ}C$ to $+125^{\circ}C$, no over-temperature LED current decrement	-4%	50	+4%	mA
Protection						
Over-voltage protection threshold	V_{OVP}		1.9	2	2.1	V
OVP hysteresis				200		mV
OVP UVLO threshold	V_{OVP_UV}	Step-up converter fails		100		mV
LEDX over-voltage threshold	V_{LEDX_OV}	STH floating or $V_{STH} = 0.5V$	4.3	4.7	5.1	V
LEDX over-voltage fault timer			6	7.7	10	ms
LEDX UVLO threshold	V_{LEDX_UV}			100		mV
Thermal shutdown threshold ⁽⁷⁾	T_{ST}	Rising edge		170		$^{\circ}C$
		Hysteresis		20		$^{\circ}C$
SD pull-down current	I_{SD}		40	55	70	μA
SD voltage (with respect to V_{IN})	V_{SD-IN}	$V_{IN} = 12V$, $V_{IN} - V_{SD}$		6		V
STH pull-up current	I_{STH}	STH pull-up current		18		μA

Notes:

- 6) Matching is defined as the difference of the maximum to minimum current divided by the setting current.
 7) Not tested in production. Guaranteed by design and characterization.

TYPICAL CHARACTERISTICS

$V_{IN} = 12V$, $T_J = -40^{\circ}C$ to $+125^{\circ}C$, unless otherwise noted.

Shutdown Current vs. Temperature

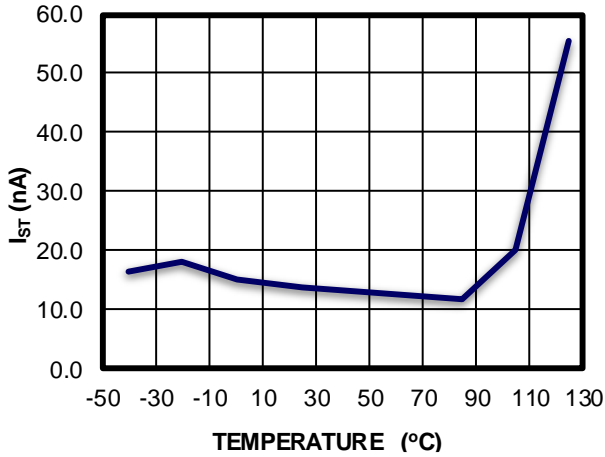

Quiescent Current vs. Temperature

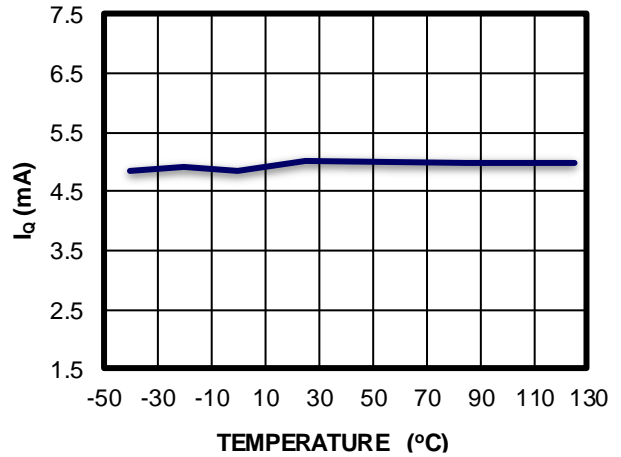

V_{IN} UVLO Threshold vs. Temperature

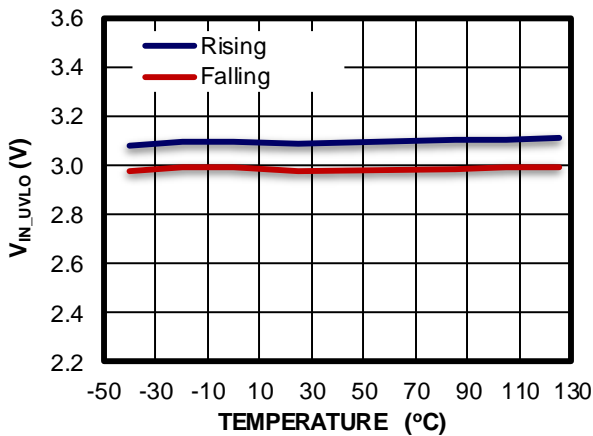

Cycle-by-Cycle Current Limit vs. Temperature

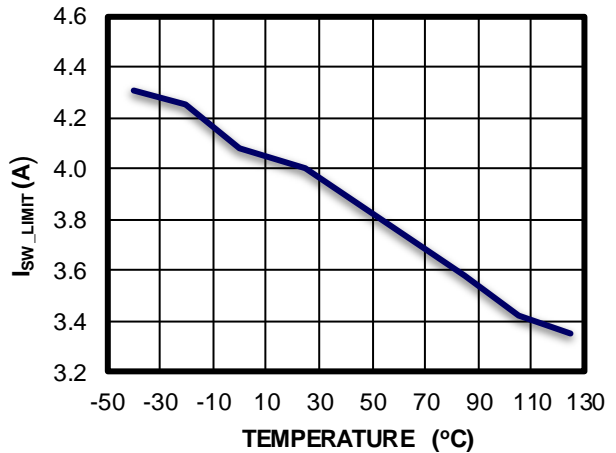

Current Limit Protection vs. Temperature

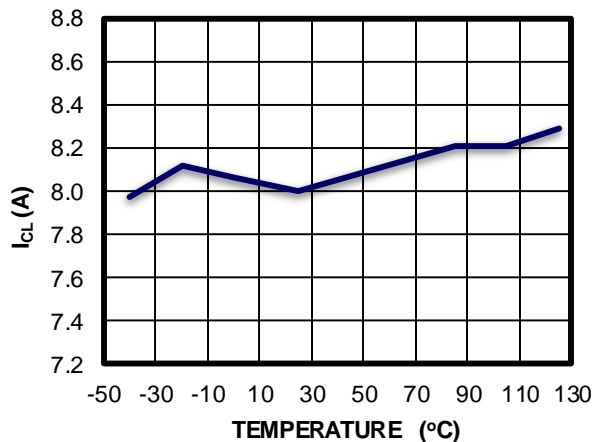

LS-FET On Resistance vs. Temperature

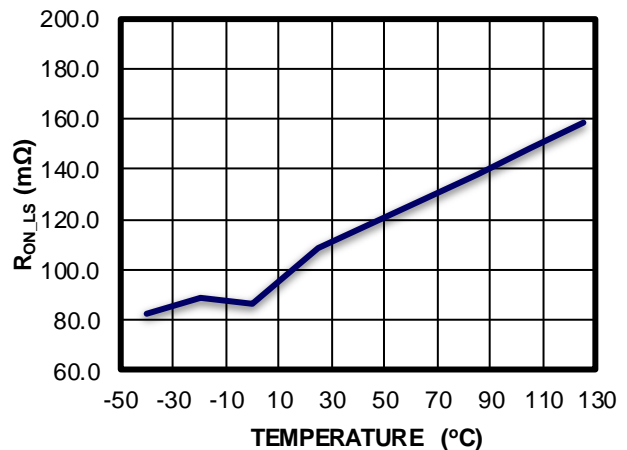

TYPICAL CHARACTERISTICS

$V_{IN} = 12V$, $T_J = -40^{\circ}C$ to $+125^{\circ}C$, unless otherwise noted.

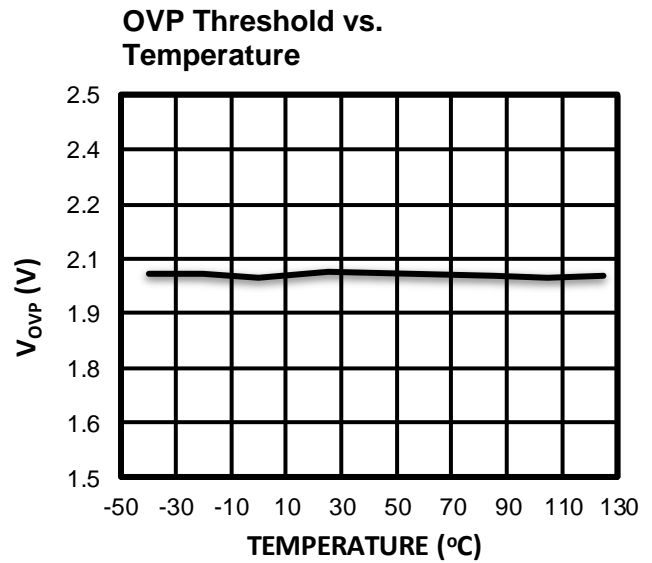
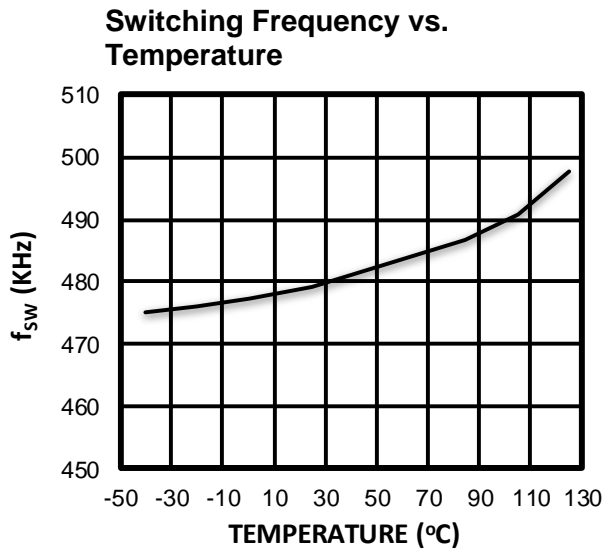

TYPICAL PERFORMANCE CHARACTERISTICS

$V_{IN} = 12V$, $L = 22\mu H$, LED = 6P12S, $f_{SW} = 470kHz$, $I_{SET} = 100mA$, $T_A = 25^\circ C$, unless otherwise noted.

Efficiency with 6P8S LED

$V_{LED} = 23V$, $I_{LED} = 6 \times I_{SET}$

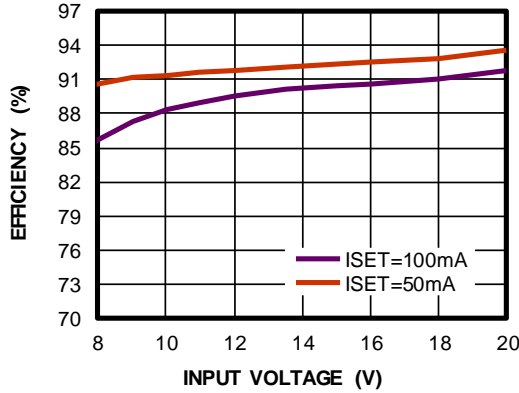

Efficiency with 6P12S LED

$V_{LED} = 34V$, $I_{LED} = 6 \times I_{SET}$

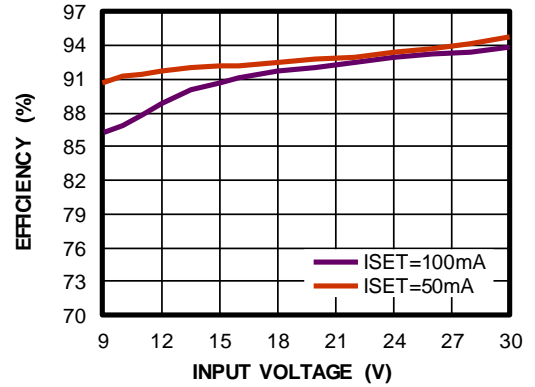

Steady State

$I_{SET} = 100mA$

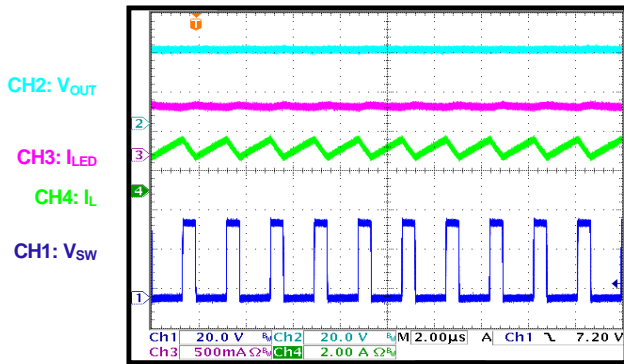

Frequency Spread Spectrum

1/20 of the center frequency

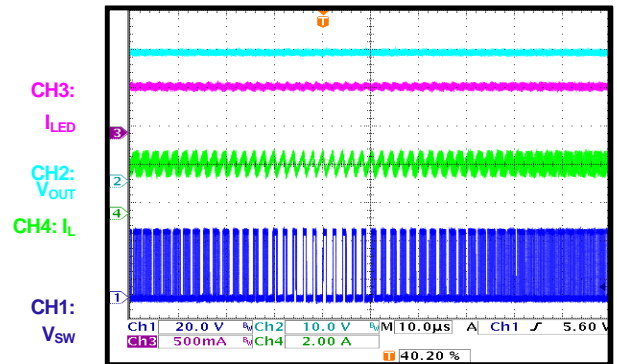

Start-Up through V_{IN}

$I_{SET} = 100mA$

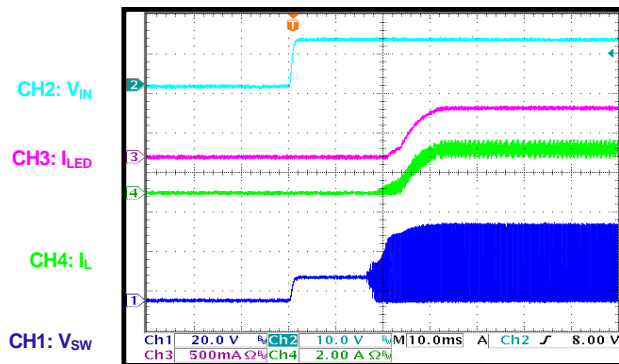

Shutdown through V_{IN}

$I_{SET} = 100mA$

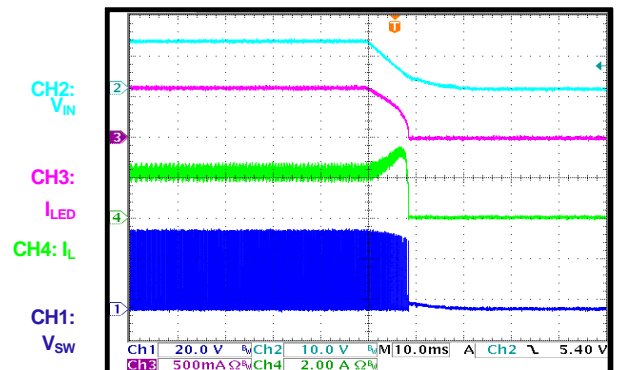

TYPICAL PERFORMANCE CHARACTERISTICS (continued)

$V_{IN} = 12V$, $L = 22\mu H$, LED = 6P12S, $f_{SW} = 470kHz$, $I_{SET} = 100mA$, $T_A = 25^\circ C$, unless otherwise noted.

Start-Up through EN
 $I_{SET} = 100mA$

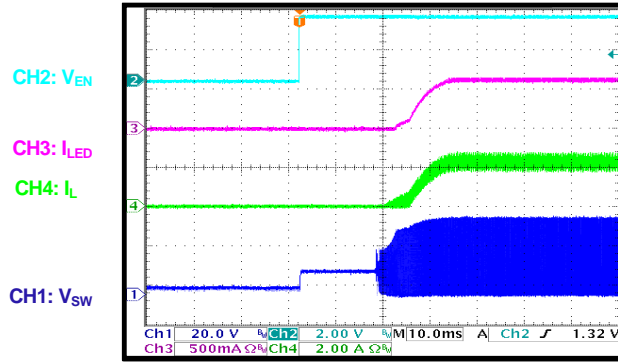

Start-Up through EN
 $I_{SET} = 100mA$

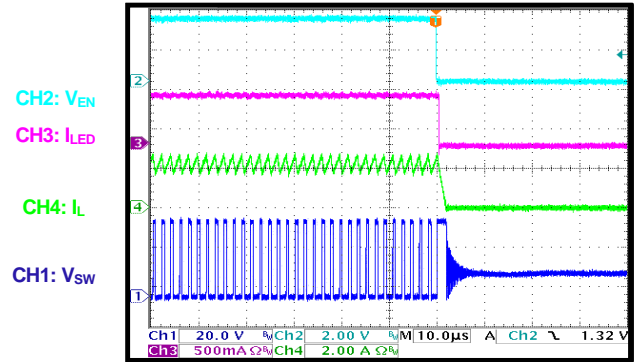

PWM Dimming Steady State
Dimming frequency = 100Hz

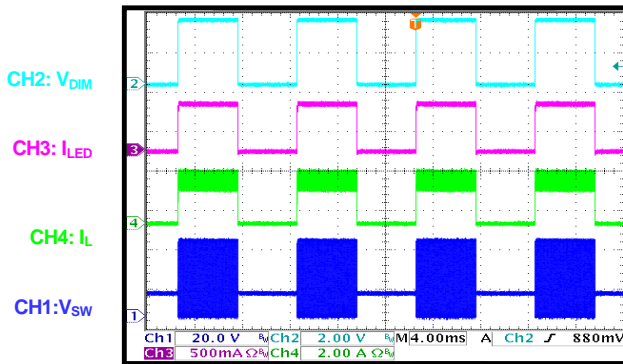

PWM Dimming Steady State
Dimming frequency = 2kHz

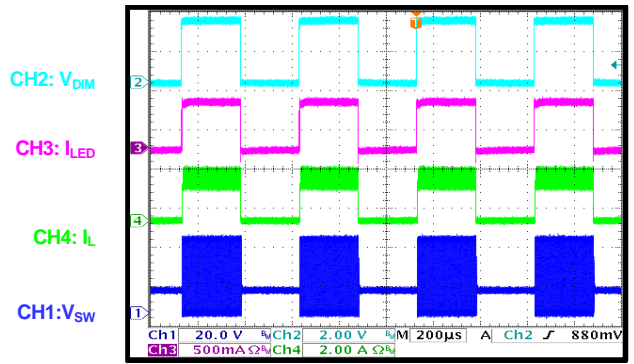

PWM Dimming Start-Up through V_{IN}

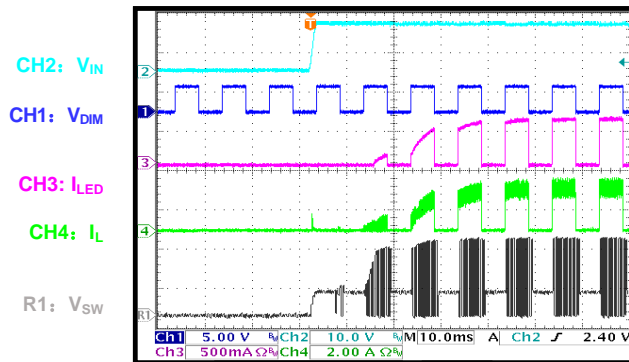

PWM Dimming Shutdown through V_{IN}

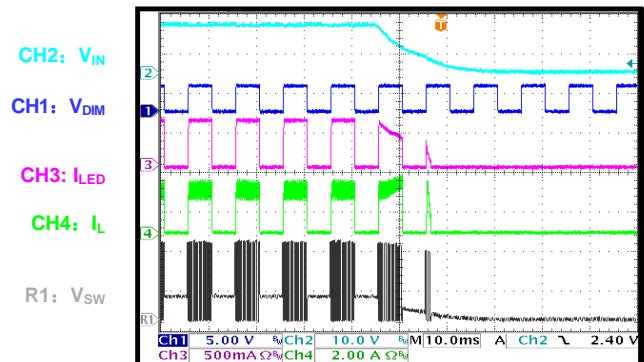

TYPICAL PERFORMANCE CHARACTERISTICS (continued)

$V_{IN} = 12V$, $L = 22\mu H$, LED = 6P12S, $f_{SW} = 470kHz$, $I_{SET} = 100mA$, $T_A = 25^\circ C$, unless otherwise noted.

PWM Dimming On

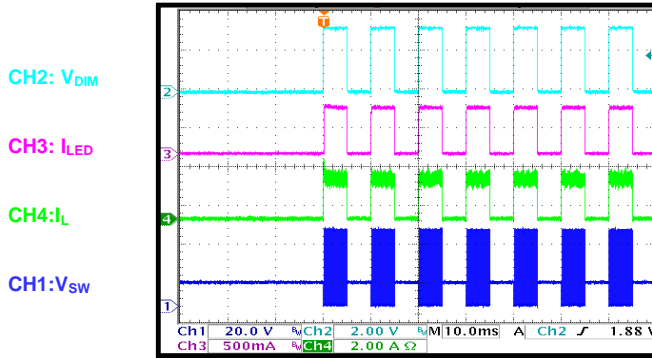

PWM Dimming Off

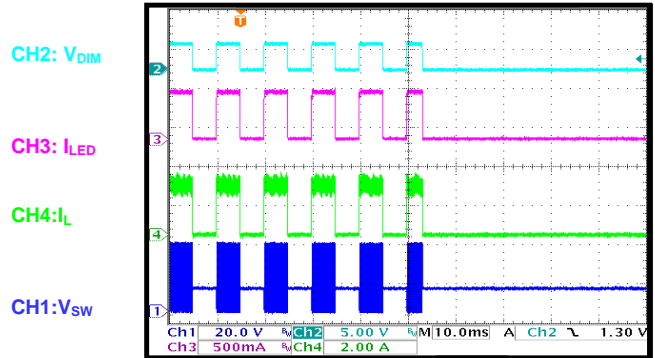

All 6 Strings LED Open Power On

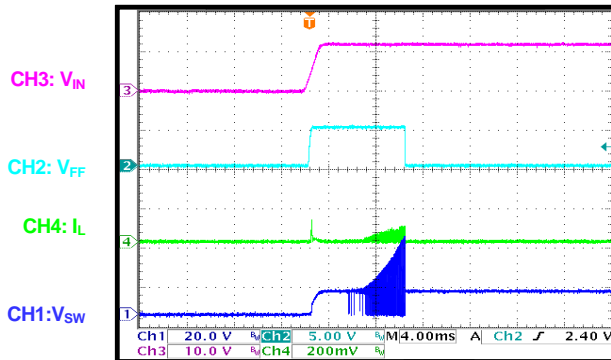

All 6 Strings LED Open Entry

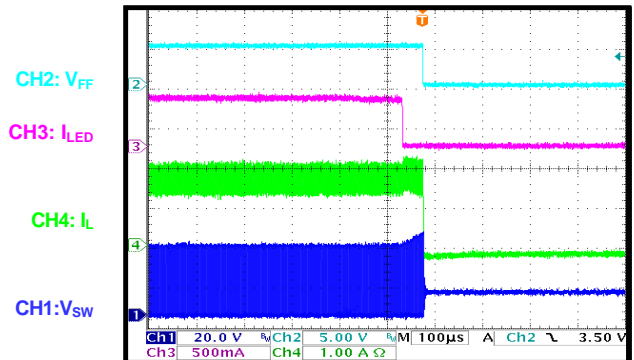

1 String LED Open Entry

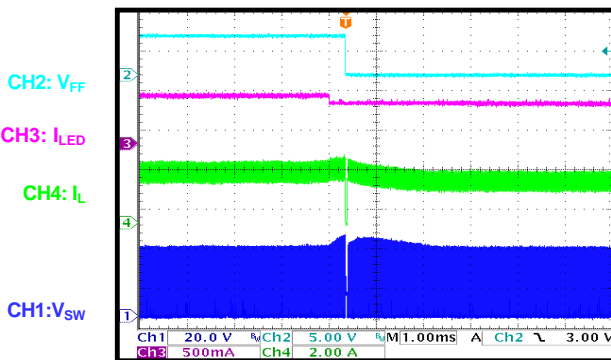

1 String LED Open Recovery

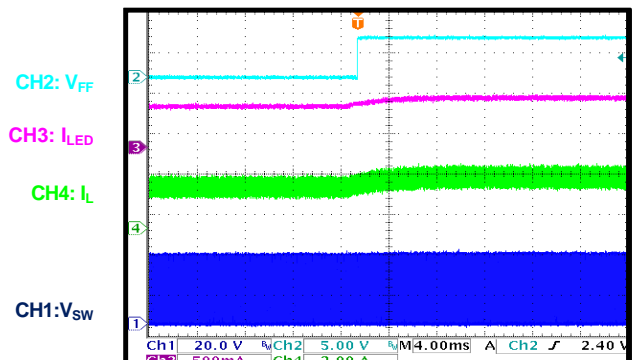

TYPICAL PERFORMANCE CHARACTERISTICS (continued)
 $V_{IN} = 12V$, $L = 22\mu H$, LED = 6P12S, $f_{SW} = 470kHz$, $I_{SET} = 100mA$, $T_A = 25^\circ C$, unless otherwise noted.

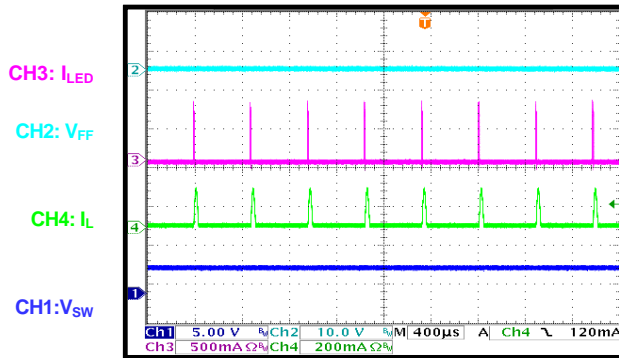
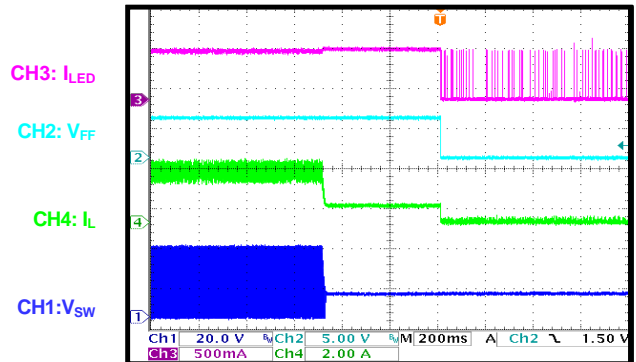
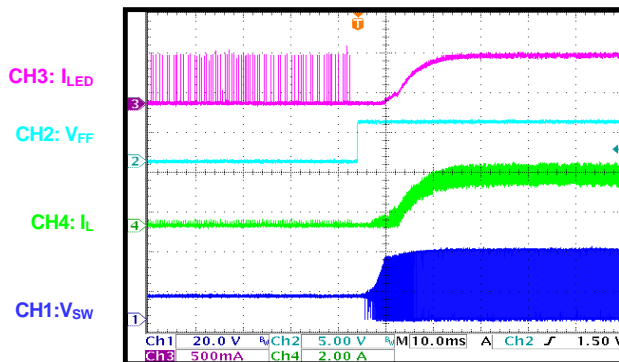
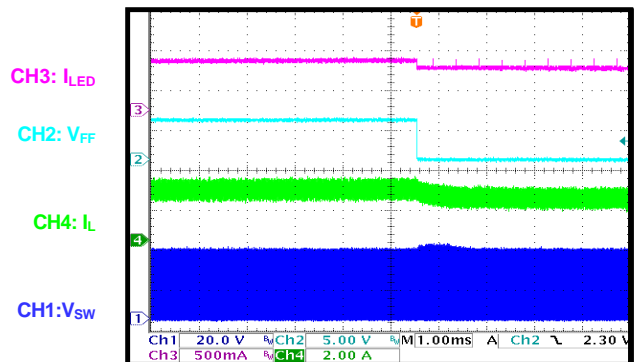
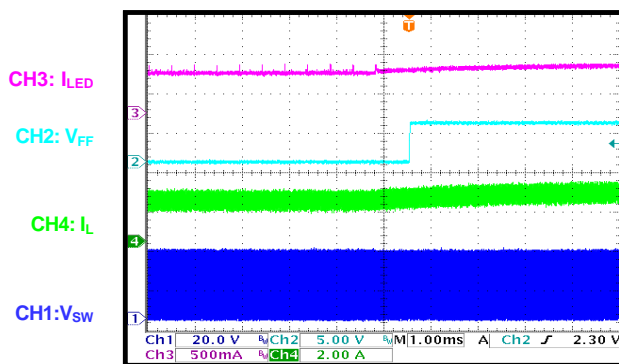
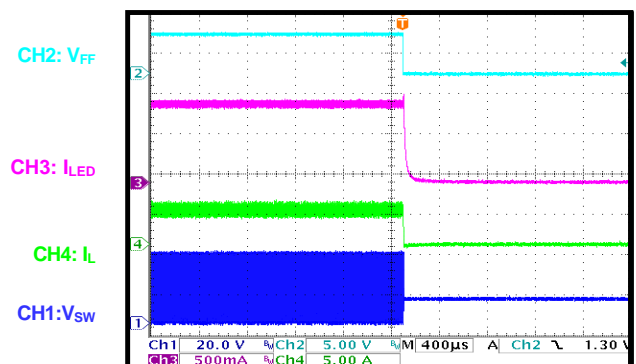
 V_{OUT} Short to LEDx Steady State

 V_{OUT} Short to LEDx Entry

 V_{OUT} Short to LEDx Recovery

Short 1 String at Working

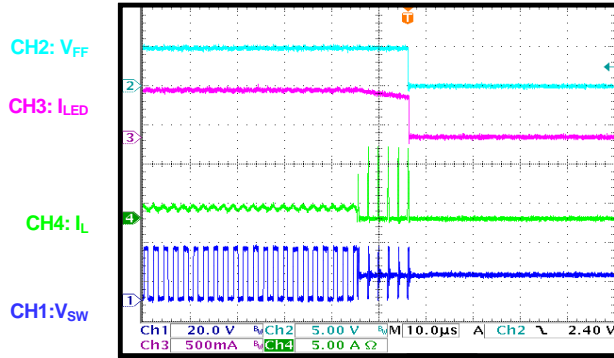
Short 1 String Recovery

LEDx Short to GND Entry

TYPICAL PERFORMANCE CHARACTERISTICS *(continued)*

$V_{IN} = 12V$, $L = 22\mu H$, LED = 6P12S, $f_{SW} = 470kHz$, $I_{SET} = 100mA$, $T_A = 25^\circ C$, unless otherwise noted.

Inductor Short Entry



FUNCTIONAL BLOCK DIAGRAM

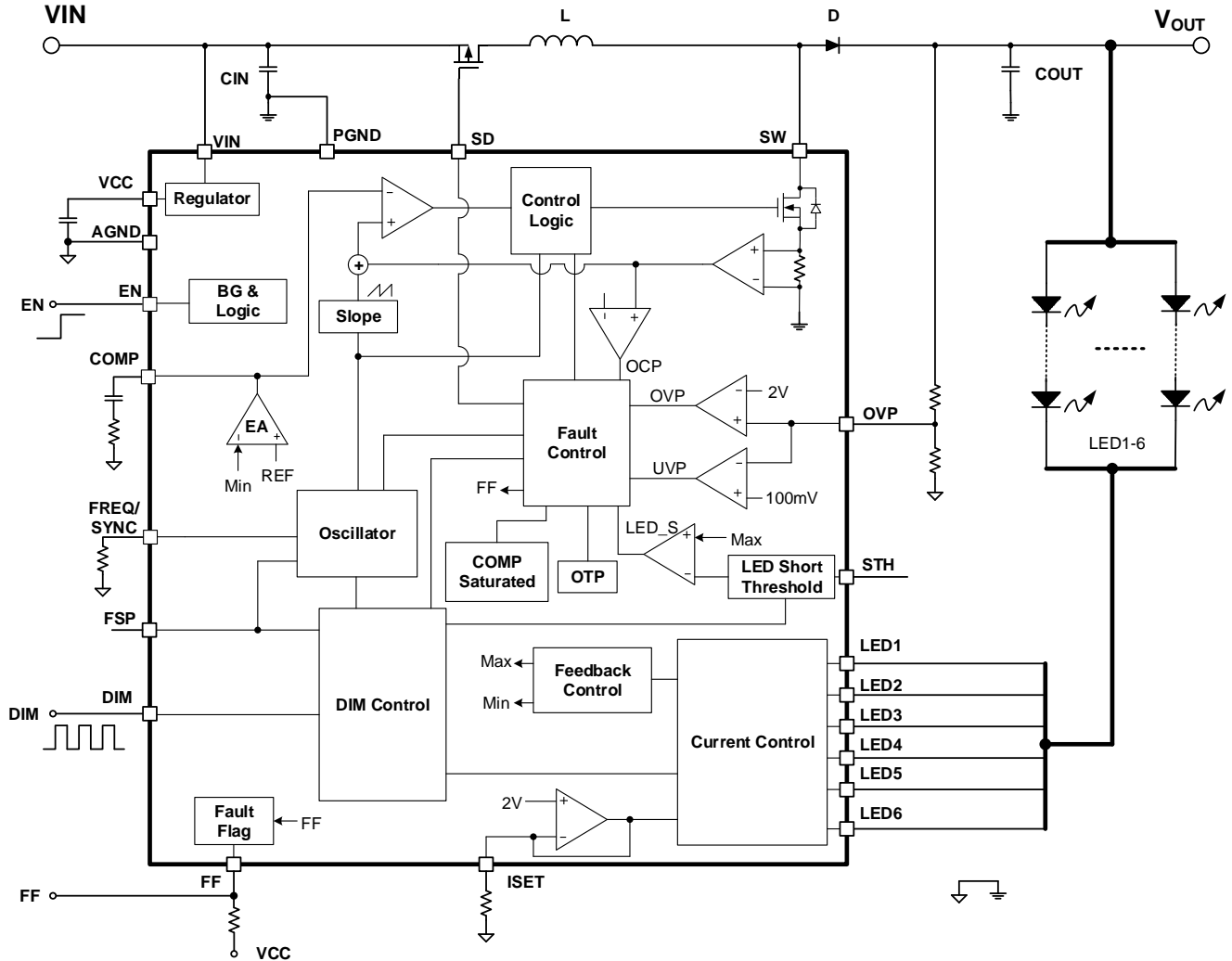

Figure 1: Functional Block Diagram

OPERATION

The MPQ7220 employs a programmable, constant-frequency, peak current mode, step-up converter with up to six channels of regulated current sources to drive the array of white LEDs.

Internal 5V Regulator

The MPQ7220 includes an internal linear regulator (VCC). When V_{IN} exceeds 6V, this regulator outputs a 5V power supply to the internal MOSFET switch gate driver and the internal control circuitry. The VCC voltage drops to 0V when the chip shuts down. The chip remains disabled until VCC exceeds the UVLO threshold.

System Start-Up

When V_{IN} , EN, and DIM are enabled, the MPQ7220 checks the topology connection. First, the IC draws current from the SD pin to enable the input disconnect PMOS turn-on (if this MOS is used). After a 500 μ s delay, the IC monitors the OVP pin to see whether the output is shorted to GND or not. If the OVP voltage is less than 100mV, the IC is disabled and latches off. After that, the MPQ7220 continues to check other safety limits, such as LED open and over-voltage protection. If all the protection tests pass, the IC then starts boosting the step-up converter with an internal soft start.

The recommended power-on sequence is the following: $V_{IN} \rightarrow EN \rightarrow$ PWM dimming signal.

Step-Up Converter

The MPQ7220 employs peak current mode control to regulate the output energy. At the beginning of each switching cycle, the internal clock turns on the internal N-MOSFET (in normal operation, the minimum on time is about 100ns). A stabilizing ramp added to the output of the current-sense amplifier prevents sub-harmonic oscillations for duty cycles greater than 50%. This result is fed into the PWM comparator. When the summed voltage reaches the output voltage of the error amplifier, the internal MOSFET turns off.

The output voltage of the internal error amplifier is an amplified signal of the difference between the reference voltage and the feedback voltage. The converter automatically chooses the lowest

active LEDx pin voltage to provide a high enough output voltage to power all the LED arrays.

If the feedback voltage drops below the reference, the output of the error amplifier increases. This results in more current flowing through the MOSFET, thus increasing the power delivered to the output. This forms a closed loop that regulates the output voltage.

Under light-load conditions, especially in the case of $V_{OUT} \approx V_{IN}$, the converter runs in pulse-skipping mode where the MOSFET turns on for a minimum on time, and then the converter discharges the power to the output for the remaining period. The external MOSFET remains off until the output voltage needs to be boosted again.

LED Current Setting

The LED current amplitude is set by an external resistor from ISET to GND. The LED current amplitude setting follows Equation (1):

$$I_{LED} \text{ (mA)} = \frac{1245}{R_{ISET} \text{ (k}\Omega\text{)}} \quad (1)$$

For $R_{ISET} = 12.4\text{k}\Omega$, the LED current is 100mA.

PWM Dimming Control

By applying a PWM signal to the DIM pin, the amplitude of the LED current remains at I_{SET} . The LED current is chopped by the input PWM signal, applying an external 100Hz to 20kHz PWM waveform to DIM for PWM dimming. During PWM dimming, the part stops switching when DIM is below 0.4V and the LED current is zero. The part resumes normal operation with a nominal LED current when DIM exceeds 1.2V.

Unused LED Channel Setting

The MPQ7220 automatically detects the unused LED string and removes it from the control loop during start-up by connecting the LEDx pin of an unused channel to GND. If employing 5 strings, connect the LED6 to GND. If using 4 strings, connect the LED5 and LED6 to GND, and so on.

Frequency Spread Spectrum

The MPQ7220 uses switching frequency jitter to spread the switching frequency spectrum. It

reduces the spectrum spike around the switching frequency and its harmonic frequencies.

The FSP pin can program the dithering range, and the modulation frequency is fixed to 1/150 of the switching frequency. FSP is a current-source output (18μA). Connect a resistor to program its voltage.

If $FSP < 0.4V$, the jitter frequency is 1/20 of the central frequency.

If $FSP = 0.45V$ to $1.4V$, the jitter frequency is 1/32 of the central frequency.

If $FSP > 1.4V$ or is left floating, the frequency spread spectrum is disabled.

Programming and Synchronizing the Switching Frequency

The switching frequency is programmed through an external resistor or an external clock on the **FREQ/SYNC** pin. The switching frequency can be determined with Equation (2):

$$F_{SW} \text{ (kHz)} = \frac{22000}{R_{FRE} \text{ (k}\Omega\text{)}} \quad (2)$$

For $R_{OSC} = 46.4k\Omega$, the switching frequency is set to 470kHz.

Synchronize the switching frequency using an external clock to improve EMI, efficiency, and thermal performance.

Protection

The MPQ7220 includes open string protection, short string protection, short LEDx to GND protection, over-current protection, short out to GND protection, and thermal protection. Once the protection is triggered, the fault flag (FF) pin pulls to GND. FF is released to high with a 750μs delay after the IC recovers from protection.

Open String Protection

Open string protection is achieved through detecting the voltage of the OVP pin and the LED1-6 pins. During operation, if one string is open, the respective LEDx pin voltage is pulled low to ground. The IC keeps charging the output voltage until it reaches the over-voltage protection (OVP) threshold. If the OVP point has been triggered, the chip stops switching and marks off the fault string that has an LEDx

pin voltage below 100mV. Once marked, the remaining LED strings force the output voltage back into normal regulation. The string with the largest voltage drop determines the output regulation value. The marked-off string sends a 10μs pulse current to check whether an open fault is removed after every 500μs delay, so open string protection is recoverable.

Short String Protection

The MPQ7220 monitors the LEDx pin voltages to determine whether a short string fault has occurred. If one or more strings are shorted, the respective LEDx pins tolerate high voltage stress. If an LEDx pin voltage exceeds the protection threshold, an internal counter is started. If this fault condition lasts for 7.7ms, the fault string is marked off and disabled. Once a string is marked off, it disconnects from the output voltage loop until the short is removed.

The short protection threshold is set by the external **STH** pin. An 18μA current flows out of the pin. Connect a resistor from **STH** to **AGND** to get a voltage (V_{STH}). The threshold is 10 times V_{STH} when $V_{STH} < 1.4V$. When **STH** is floating or $V_{STH} > 1.4V$, the short protection threshold is set to 5V.

When all LEDx voltages exceed the threshold for 480ms, all strings are marked off. The IC is on standby until the strings release from shorting.

Short LEDx to GND Protection

When LEDx shorts to GND, the **COMP** voltage increases and saturates. When the **COMP** saturated time lasts for 20ms, protection is triggered, the **FF** pin pulls low, and the **SD** pin is pulled high to turn off the external P-MOSFET. The IC also latches off.

Short V_{OUT} to GND Protection

When V_{OUT} shorts to GND, the **OVP** voltage decreases and kicks the low threshold for 10μs. Then the protection is triggered. The **SD** pin is pulled high to turn off the external P-MOSFET, and V_{OUT} is disconnected from V_{IN} .

Cycle-by-Cycle Current Limit

To prevent the external components from exceeding the current stress rating, the IC has cycle-by-cycle current limit protection. When the

current exceeds the current limit value, the IC stops switching until the next clock cycle.

Latch-Off Current Limit Protection

Extreme conditions like excess current or an inductor short may cause device damage. Therefore, the MPQ7220 provides a latch-off current limit protection when the current flowing through an internal MOSFET reaches the threshold (8A) and lasts for five switching cycles.

Thermal Protection

To prevent the IC from damage when operating at exceedingly high temperatures, thermal protection is implemented in this chip by detecting the silicon die temperature.

Over-Temperature LED Current Decrement

When the die temperature exceeds 140°C, the MPQ7220 automatically decreases the LED current amplitude.

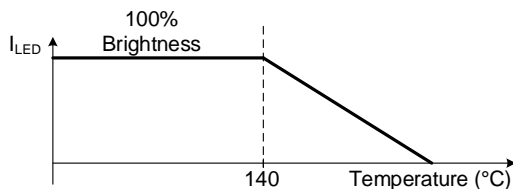

Figure 2: I_{LED} Decreases with Temperature

Thermal Shutdown

When the die temperature exceeds the upper threshold (T_{ST}), the IC shuts down. It recovers to normal operation when the die temperature drops below the lower threshold. The hysteresis value is typically 20°C.

APPLICATION INFORMATION

LED Current Setting

The LED current amplitude is set by an external resistor connected from ISET to GND. The LED current amplitude setting is determined with Equation (3):

$$I_{LED} \text{ (mA)} = \frac{1245}{R_{ISET} \text{ (k}\Omega\text{)}} \quad (3)$$

For $R_{ISET} = 12.4\text{k}\Omega$, the LED current is 100mA.

Setting the Over-Voltage Protection (OVP)

The voltage divider sets the over-voltage protection (OVP) point (see Figure 3). Calculate V_{OVP} with Equation (4):

$$V_{OVP} \text{ (V)} = 2V \times \frac{R_3 + R_4}{R_4} \quad (4)$$

Normally, the OVP point is set about 10% to 30% higher than the LED voltage.

Switching Frequency

The frequency can be programmed by an external resistor or an external clock on the FREQ/SYNC pin. Calculate the switching frequency using Equation (5):

$$f_{SW} \text{ (kHz)} = \frac{22000}{R_{FRE} \text{ (k}\Omega\text{)}} \quad (5)$$

For $R_{FRE} = 46.4\text{k}\Omega$, the switching frequency is set to 470kHz.

Synchronize the switching frequency using an external clock to improve EMI, efficiency, and thermal performance.

Selecting the Input Capacitor

The input capacitor reduces the surge current drawn from the input supply and the switching noise from the device. The input capacitor impedance at the switching frequency should be less than the input source impedance to prevent the high-frequency switching current from passing through to the input. Use ceramic capacitors with X5R or X7R dielectrics for their low ESR and small temperature coefficients.

For most applications, a $10\mu\text{F}$ ceramic capacitor is sufficient.

Selecting the Inductor

The MPQ7220 requires an inductor to supply a higher output voltage while being driven by the input voltage. A larger-value inductor results in less ripple current, lower peak inductor current, and less stress on the internal N-channel MOSFET. However, the larger-value inductor has a larger physical size, higher series resistance, and lower saturation current.

Choose an inductor that does not saturate under worst-case load conditions. Select the minimum inductor value to ensure that the boost converter works in continuous conduction mode with high efficiency and good EMI performance.

Calculate the required inductance value using Equation (6) and Equation (7):

$$L \geq \frac{\eta \times V_{OUT} \times D \times (1-D)^2}{2 \times f_{SW} \times I_{LOAD}} \quad (6)$$

$$D = 1 - \frac{V_{IN}}{V_{OUT}} \quad (7)$$

Where V_{IN} and V_{OUT} are the input and output voltages, respectively. f_{SW} is the switching frequency, I_{LOAD} is the LED load current, and η is the efficiency.

With the given inductor value, the inductor DC current rating is at least 40% greater than the maximum input peak inductor current for most applications. The inductor's DC resistance should be as small as possible for higher efficiency.

Selecting the Output Capacitor

The output capacitor keeps the output voltage ripple small and ensures feedback loop stability. The output capacitor impedance must be low at the switching frequency. Ceramic capacitors with X7R dielectrics are recommended for their low ESR characteristics. For most applications, a $10\mu\text{F}$ ceramic capacitor is sufficient.

TYPICAL APPLICATION CIRCUITS

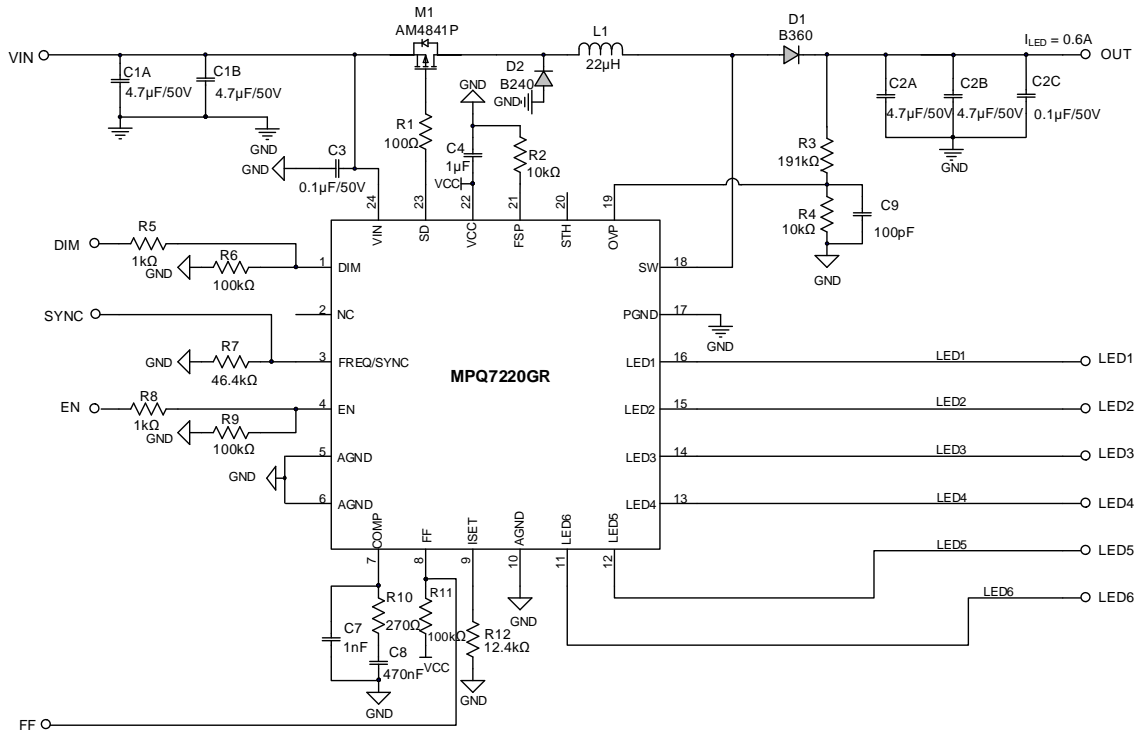

Figure 3: $I_{SET} = 100mA$, $f_{sw} = 470kHz$, Application Circuit for QFN-24 Package

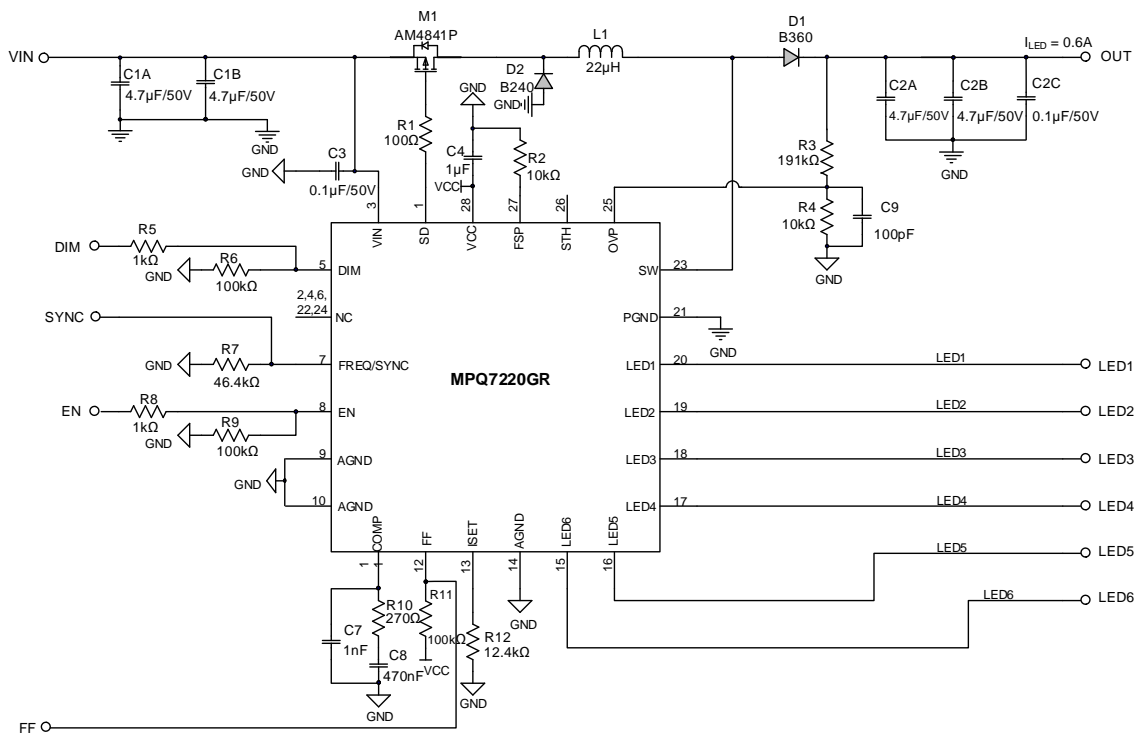
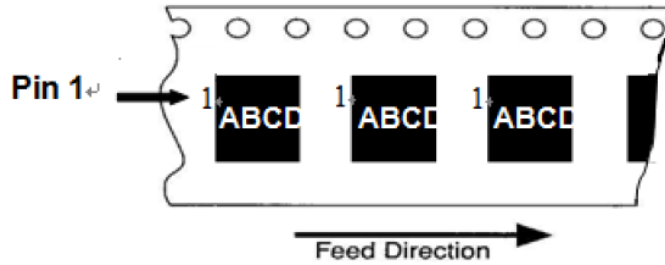
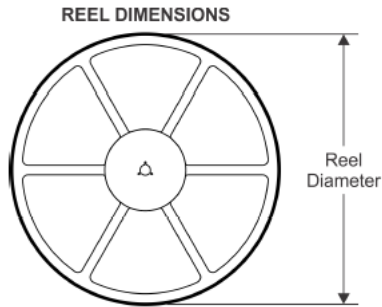

Figure 4: $I_{SET} = 100mA$, $f_{sw} = 470kHz$, Application Circuit for TSSOP-28 Package

CARRIER INFORMATION

QFN-24 (4mmx4mm)



TSSOP28-EP

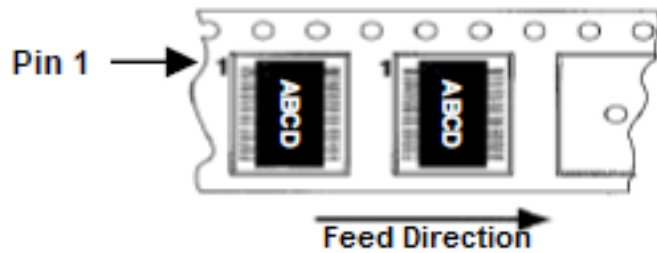
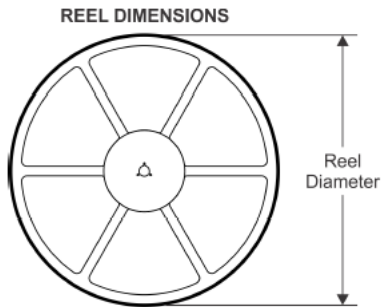

Part Number	Package Description	Quantity/Reel	Quantity/Tube	Reel Diameter	Carrier Tape Width	Carrier Tape Pitch
MPQ7220GR	QFN-24 (4mmx4mm)	2500	NA	13in.	12mm	8mm
MPQ7220GF	TSSOP28-EP	2500	50	13in.	16mm	8mm

PACKAGE INFORMATION

QFN-24 (4mmx4mm)

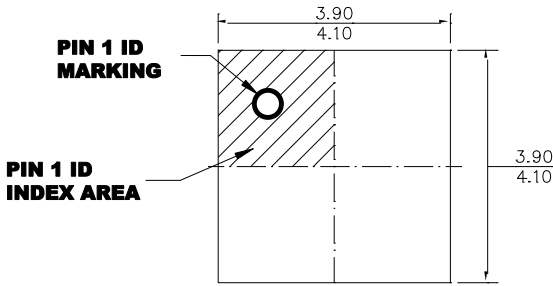

TOP VIEW

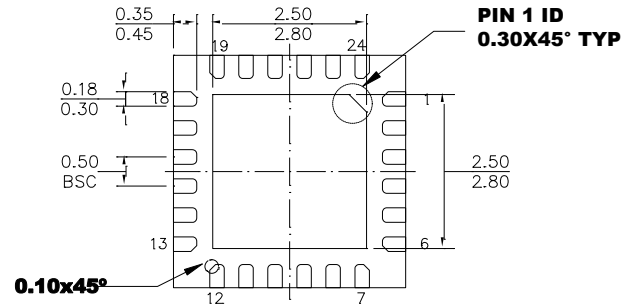

BOTTOM VIEW

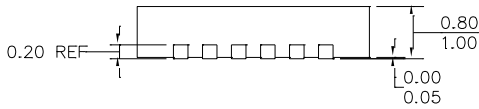

SIDE VIEW

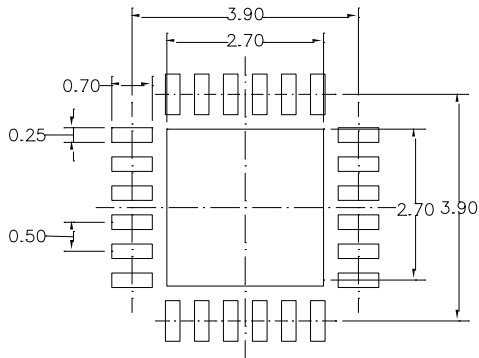

RECOMMENDED LAND PATTERN

NOTE:

- 1) ALL DIMENSIONS ARE IN MILLIMETERS.
- 2) EXPOSED PADDLE SIZE DOES NOT INCLUDE MOLD FLASH.
- 3) LEAD COPLANARITY SHALL BE 0.08 MILLIMETERS MAX.
- 4) JEDEC REFERENCE IS MO-220
- 5) DRAWING IS NOT TO SCALE.

PACKAGE INFORMATION

TSSOP28-EP

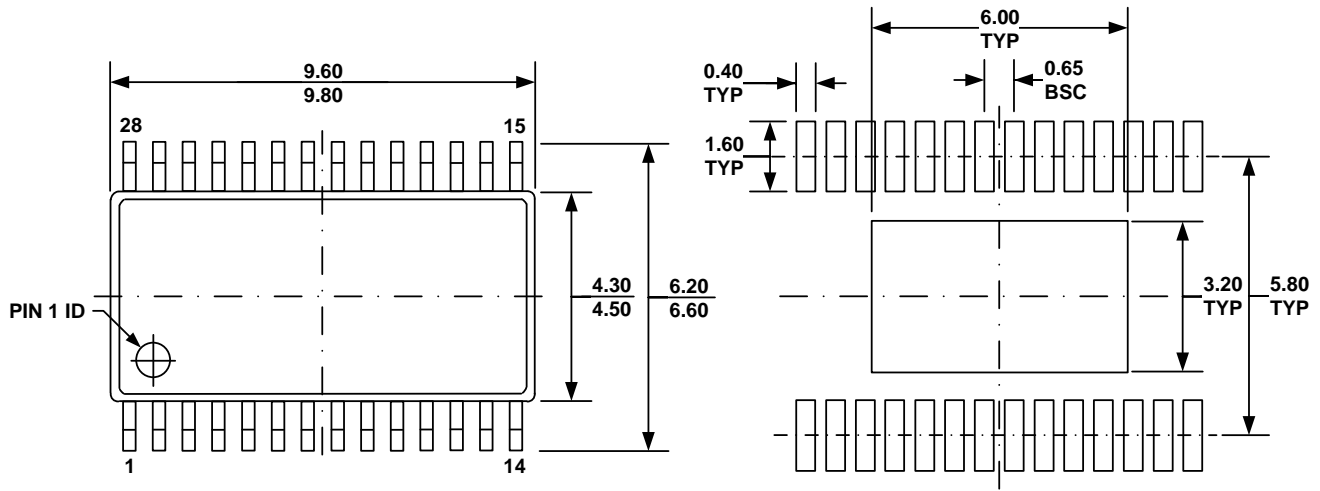

TOP VIEW

RECOMMENDED LAND PATTERN

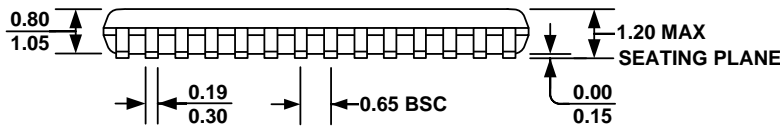

FRONT VIEW

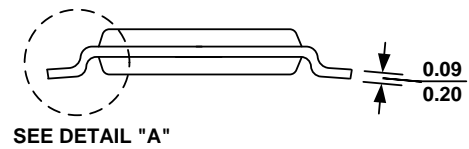

SIDE VIEW

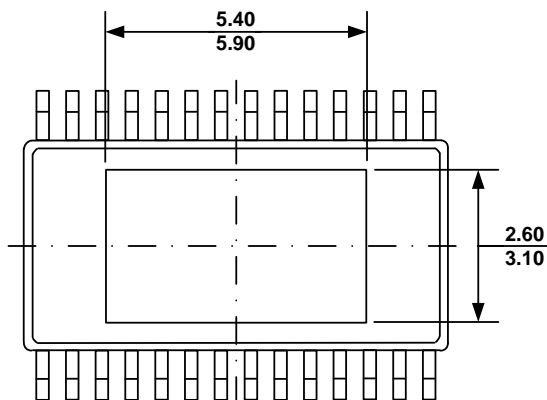

BOTTOM VIEW

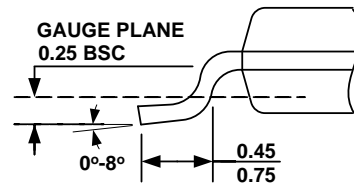

DETAIL "A"

NOTE:

- 1) ALL DIMENSIONS ARE IN MILLIMETERS.
- 2) PACKAGE LENGTH DOES NOT INCLUDE MOLD FLASH, PROTRUSION OR GATE BURR.
- 3) PACKAGE WIDTH DOES NOT INCLUDE INTERLEAD FLASH OR PROTRUSION.
- 4) LEAD COPLANARITY (BOTTOM OF LEADS AFTER FORMING) SHALL BE 0.10 MILLIMETERS MAX.
- 5) DRAWING CONFORMS TO JEDEC MO-153, VARIATION AET.
- 6) DRAWING IS NOT TO SCALE.

NOTICE: The information in this document is subject to change without notice. Please contact MPS for current specifications. Users should warrant and guarantee that third-party Intellectual Property rights are not infringed upon when integrating MPS products into any application. MPS will not assume any legal responsibility for any said applications.