

C1005X7R1V224K050BC

TDK item description : C1005X7R1V224KT****



Application & Main Feature

Commercial grade (General type)

Series

C1005 [EIA 0402]

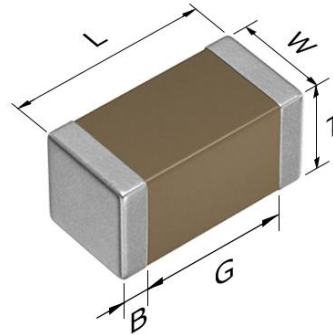

Dimensions

L 1.00±0.05 mm
 W 0.50±0.05 mm
 T 0.50±0.05 mm
 B 0.10 mm min.
 G 0.30 mm min.

Temperature Characteristic

X7R (-55 to +125 degC, ±15%)

Rated Voltage

1V (35Vdc)

Capacitance

220nF

Capacitance Tolerance

K (±10%)

DF

5 % max.

Insulation Resistance

2272 Mohm min.

AEC-Q200

Not Applicable

Characterization Sheet (Multilayer Ceramic Chip Capacitors)

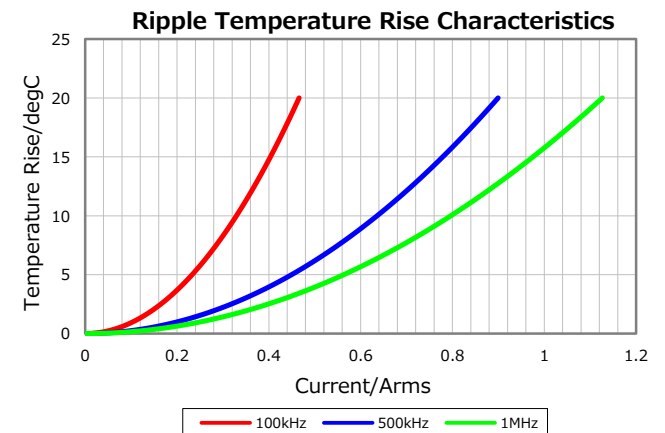
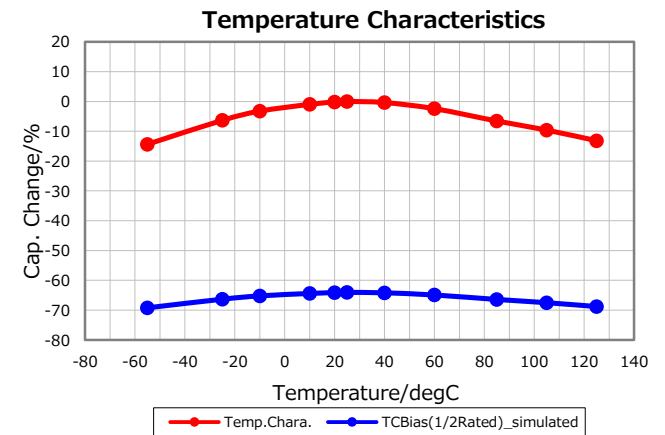
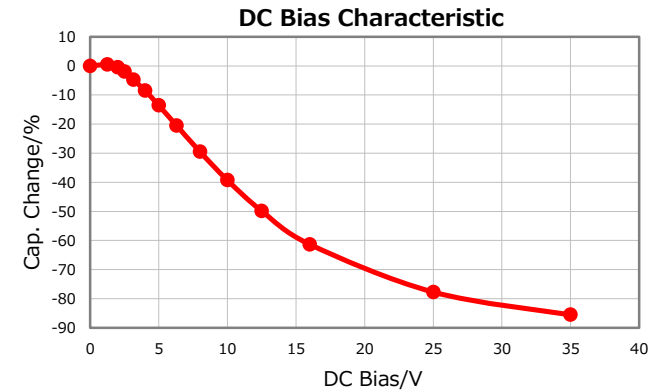
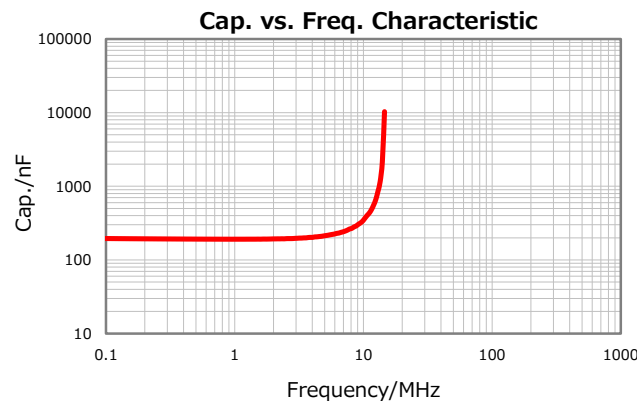
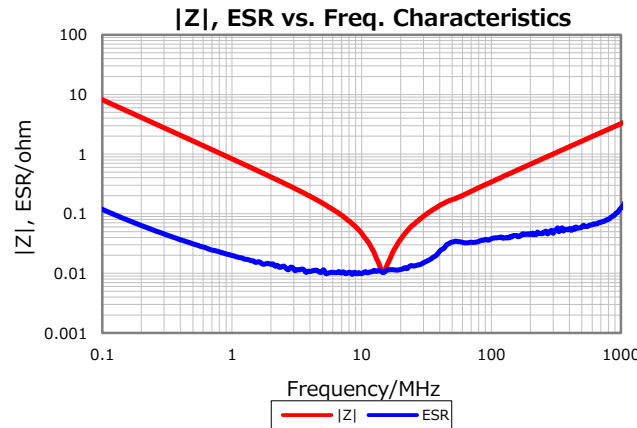

⚠ All specifications are subject to change without notice.

January 10, 2021