

0.56" Single Digit Common Cathode 7 Segment LED Display -Red

multicomp PRO

**RoHS
Compliant**

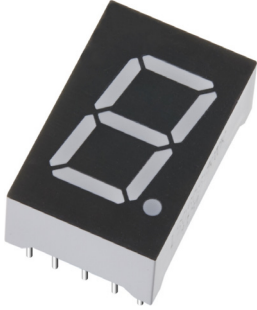

Features

Package Size	: 0.56 inch Single Digit Common Cathode LED Display
Dice Material	: AlInGaP
Peak Wave Length (nm)	: 650
Emitted Colour	: Super Red
Peak Wave Length (nm)	: 650
Emitted Colour	: Super Red
Epoxy Colour	: White Diffused
IV (mcd)	: 5.0
Surface Inc Colour	: Black

Electrical / Optical Characteristics at Ta = 25°C

Parameter	Symbol	Min.	Typ.	Max.	Unit	Condition
Luminous Intensity	IV	3.0	5	7.5	mcd	IF = 20mA
Peak Emission Wavelength	λ_p		650		nm	
Dominant Wavelength	λ_D	635	640	645	nm	
Spectral Line Half-Width	$\Delta\lambda$		20		nm	
Forward Voltage	VF	1.8	1.9	2.2	V	
Reverse Current	Ir	-	-	10	uA	VR=5V

▲ Luminous intensity (IV) $\pm 10\%$, Forward Voltage (VF) $\pm 0.1V$, Wavelength (λ_d) $\pm 0.5nm$

Absolute Maximum Ratings: (Ta = 25°C)

Parameter	Symbol	Rating	Unit
Power Dissipation	Pd	85	mW
Peak Forward Current (Duty 1/10 @ 1KHz)	IF (Peak)	100	mA
Recommended Operating Current	IF (Rec)	30	mA
Electrostatic Discharge	ESD _{HBM}	2000	V
Operating Temperature Range	T _{OPR}	-40 to +85	°C
Storage Temperature Range	T _{STG}	-40 to +100	°C
Lead Soldering Temperature Range (1.6 mm (1/16 inch) from body)	Reflow Soldering: 260°C for 5 sec. Hand Soldering: 350°C for 3 sec.		

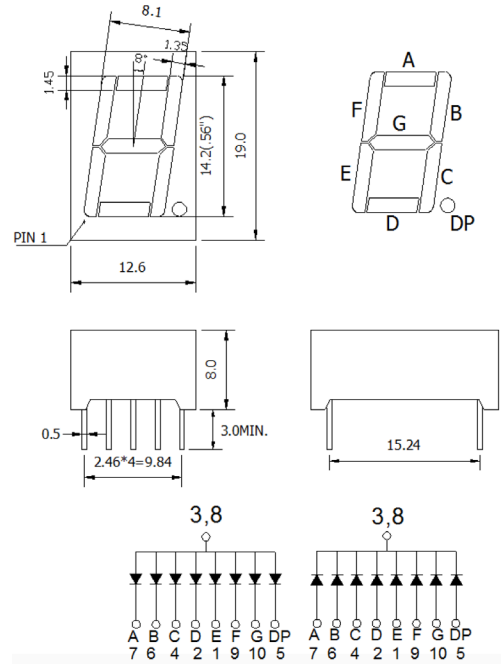

Dimensions : Millimetres

Newark.com/multicomp-pro
Farnell.com/multicomp-pro
Element14.com/multicomp-pro

multicomp PRO

0.56" Single Digit Common Cathode 7 Segment LED Display -Red

multicomp PRO

Typical Electro-Optical Characteristics Curves

Super Red (AlInGaP $\lambda_d=640\text{nm}$)

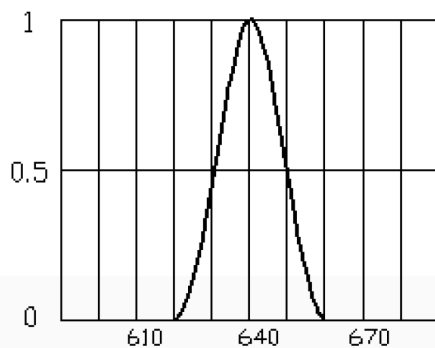
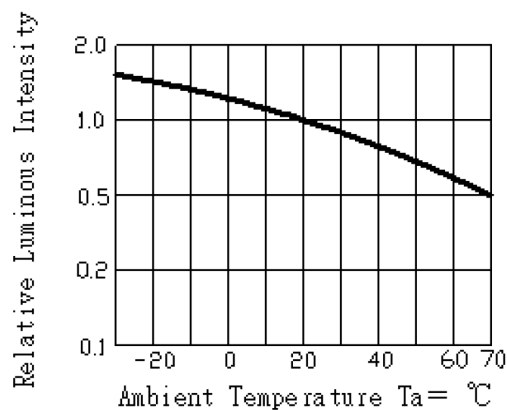
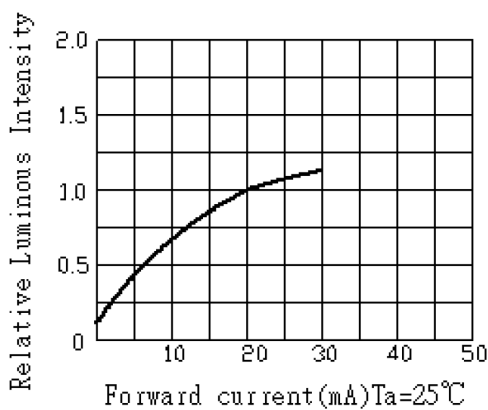
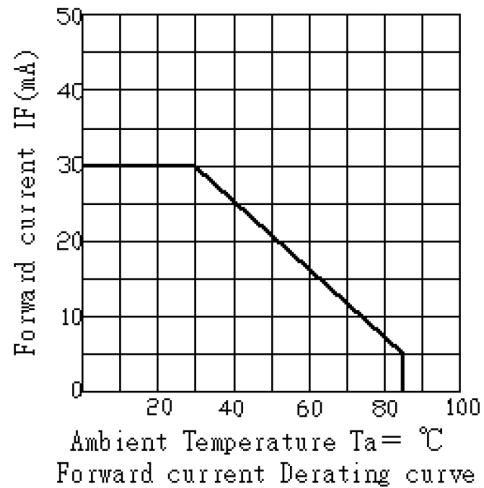
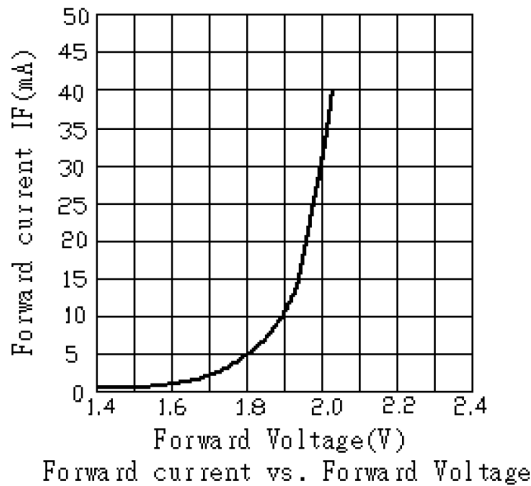

0.56" Single Digit Common Cathode 7 Segment LED Display -Red

multicomp PRO

Reliability Test

NO.	Item	Test Conditions	Test Time/ Cycle	Sample Size	Ac/Re
1	DC Operating Life	Temperature:25°C IF:20mA	1000 HRS	20 PCS	0/1
2	High Temperature High Humidity	Temperature:85°C 85%RH			
3	High Temperature Storage	Temperature:100°C			
4	Low Temperature Storage	Temperature:-40°C			
5	Temperature Cycling	85°C~ 25°C~-35°C 15min~ 5min~ 15min	15 Cycles		
6	Thermal Shock	85°C~ 25°C~-10°C 5min~ 10sec~ 5min			
7	Solder Heat	Temperature:260°C±5°C	10 sec.		

Precautions for Using LED

1. Drive Method

LED is current-operated device. In order to ensure intensity uniformity on multiple LEDs connected in parallel in an application, it is recommended that a current limiting resistor be incorporated in the drive circuit

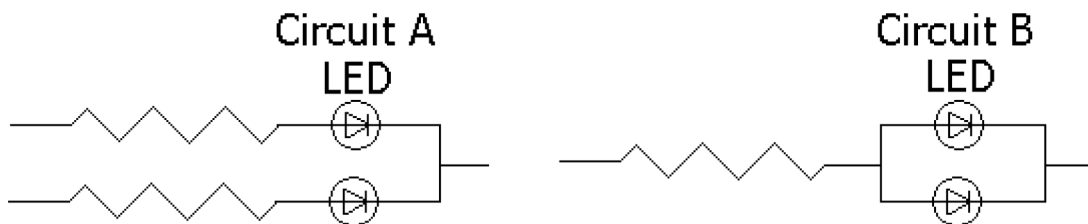

(a) Circuit A: it is recommended circuit.

(b) Circuit B: the brightness of each LED might appear different due to the differences in the I-V characteristics of those LEDs.

2. Over-current-proof

Customer must apply resistors for protection, otherwise slight voltage shift will cause big current change (Burn out will happen).

3. Storage

The Storage Temperature and RH are: 5°C ~ 30°C, RH 60% or less.

Once the package is opened, the products should be used within a week. Otherwise, they should be kept in moisture proof package with moisture absorbent material (silica gel).

We suggest our customers to use the products within a year.

If the moisture absorbent material (silica gel) has faded or the LEDs exceeded the storage time, baking treatment should be performed using the following conditions:

Baking treatment: more than 24 hours at 60°C ±5°C.

0.56" Single Digit Common Cathode 7 Segment LED Display -Red

multicomp PRO

4. Electrostatic Discharge (ESD)

Static electricity or surge voltage will damage the LEDs. Suggestions to prevent ESD damage:

Use of a conductive wrist band or ante-electrostatic glove while handling the LEDs.

All devices, equipment, and machinery must be properly grounded.

Work tables storage racks, etc. should be properly grounded.

In the events of manual working in process, make sure the devices are well protected from ESD at any time.

5. Others

(a) If you want to have the uniform luminance and Colour, please use the same binning number, and components from mixed bins will cause the differences of luminance and Colours.

(b) The appearance and specifications of the product may be modified for improvement without prior notice.

6. Soldering

Recommended soldering condition as shown below:

● Soldering heat (DIP)

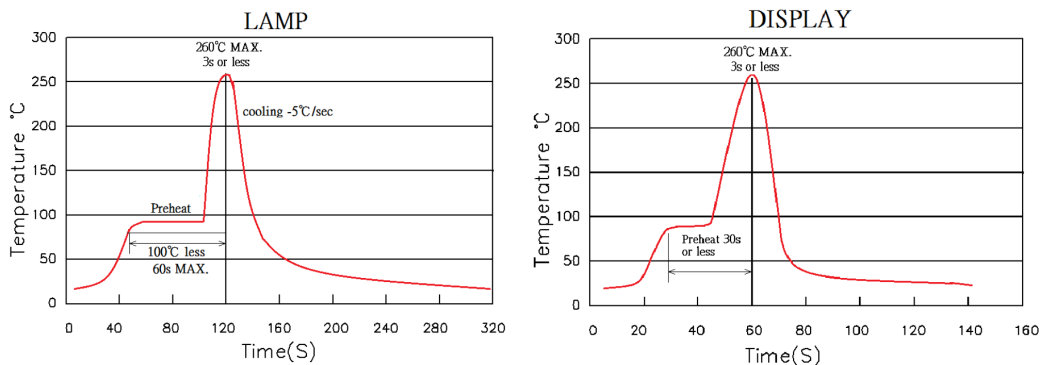

Soldering Iron

Temperature at tip of iron: 350°C Max.

Soldering Time: 3 sec. ± 1 sec. (one time only)

If temperature is higher, time should be shorter.

● Reflow Temp./Time (SMD)

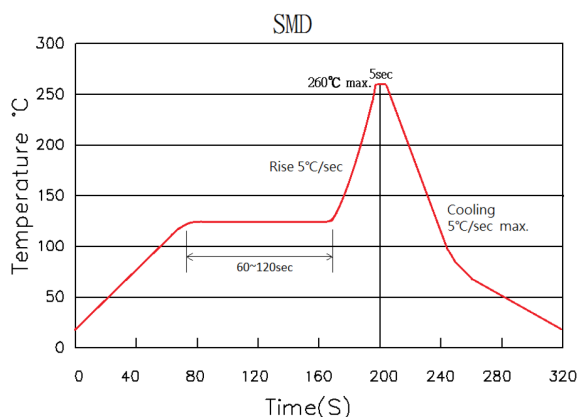

0.56" Single Digit Common Cathode 7 Segment LED Display -Red

multicomp PRO

Part Number Table

Description	Part Number
7 Segment LED Display, Single Digit, 0.56", Red, Common Cathode	MP006831

Important Notice : This data sheet and its contents (the "Information") belong to the members of the AVNET group of companies (the "Group") or are licensed to it. No licence is granted for the use of it other than for information purposes in connection with the products to which it relates. No licence of any intellectual property rights is granted. The Information is subject to change without notice and replaces all data sheets previously supplied. The Information supplied is believed to be accurate but the Group assumes no responsibility for its accuracy or completeness, any error in or omission from it or for any use made of it. Users of this data sheet should check for themselves the Information and the suitability of the products for their purpose and not make any assumptions based on information included or omitted. Liability for loss or damage resulting from any reliance on the Information or use of it (including liability resulting from negligence or where the Group was aware of the possibility of such loss or damage arising) is excluded. This will not operate to limit or restrict the Group's liability for death or personal injury resulting from its negligence. Multicomp Pro is the registered trademark of Premier Farnell Limited 2019.

Newark.com/multicomp-pro
Farnell.com/multicomp-pro
Element14.com/multicomp-pro

multicomp PRO