



## Product Change Notification / KSRA-15BCAH919

---

**Date:**

09-Dec-2020

**Product Category:**

Memory

**PCN Type:**

Manufacturing Change

**Notification Subject:**

CCB 4437 Final Notice: Implement MMT shipping tube for selected AT27xxxx, AT28xxxx and SST39xxxx products available in 32L PLCC package.

**Affected CPNs:**

[KSRA-15BCAH919\\_Affected\\_CPN\\_12092020.pdf](#)  
[KSRA-15BCAH919\\_Affected\\_CPN\\_12092020.csv](#)

**Notification Text:****PCN Status:**

Final notification.

**PCN Type:** Manufacturing Change

**Microchip Parts Affected:** Please open one of the icons found in the Affected CPNs section above.

NOTE: For your convenience Microchip includes identical files in two formats (.pdf and .xls).

**Description of Change:** Implement MMT shipping tube for selected AT27xxxx, AT28xxxx and SST39xxxx products available in 32L PLCC package.

**Pre Change:**

LPI shipping tube

**Post Change:**

MMT shipping tube

**Pre and Post Change Summary:**

	Pre Change	Post Change
Shipping Tube	LPI shipping tube	MMT shipping tube
	See attached photos for the pre and post changes	

**Impacts to Data Sheet:** None

**Change Impact:**None

**Reason for Change:**To improve on-time delivery performance by implementing MMT shipping tube

**Change Implementation Status:**In Progress

**Estimated First Ship Date:**

December 26, 2020 (date code: 2052)

NOTE: Please be advised that after the estimated first ship date customers may receive pre and post change parts.

**Time Table Summary:**

	November 2020				December 2020			
Workweek	45	46	47	48	49	50	51	52
Final PCN Issue Date				X				
Estimated Implementation Date								X

**Method to Identify Change:** Traceability code, shipping tube

**Qualification Report:**Not applicable

**Revision History:****November 26, 2020:** Issued final notification. **December 09, 2020:** Re-issued final notification to update affected CPN List.

The change described in this PCN does not alter Microchip's current regulatory compliance regarding the material content of the applicable products.

**Attachments:**

[PCN\\_KSRA-15BCAH919\\_Pre and Post Change Summary.pdf](#)

Please contact your local [Microchip sales office](#) with questions or concerns regarding this notification.

**Terms and Conditions:**

If you wish to receive Microchip PCNs via email please register for our PCN email service at our [PCN home page](#) select register then fill in the required fields. You will find instructions about registering for Microchips PCN email service in the [PCN FAQ](#) section.

If you wish to change your PCN profile, including opt out, please go to the [PCN home page](#) select login and sign into your myMicrochip account. Select a profile option from the left navigation bar and make the applicable selections.

Affected Catalog Part Numbers (CPN)

AT28C64B-15JU  
AT28HC64B-70JU  
AT28HC64B-90JU  
AT28HC64B-12JU  
AT28HC64BF-12JU  
AT28BV64B-20JU  
AT27BV256-70JU  
AT27LV256A-90JU  
AT27LV512A-90JU  
AT27BV010-90JU  
AT27LV010A-70JU  
AT27LV020A-12JU  
AT27C256R-45JU  
AT27C256R-70JU  
AT27C256R-70JU-306  
AT27C512R-45JU  
AT27C512R-70JU  
AT27C020-55JU  
AT27C020-90JU  
AT27C010-45JU  
AT27C010-70JU  
SST39LF040-55-4C-NHE  
SST39LF020-55-4C-NHE  
SST39LF010-55-4C-NHE  
SST39LF020-55-4C-NHE-RVL  
SST39LF040-55-4C-NHE-RVL  
SST39VF040-70-4C-NHE  
SST39VF020-70-4C-NHE  
SST39VF010-70-4C-NHE  
SST39VF040-70-4C-NHE-DP003  
SST39VF040-70-4C-NHE-PP013  
SST39VF040-70-4C-NHE-RVL  
SST39LF040-55-4C-NHE-A3  
SST39VF020-70-4C-NHE-RVL  
SST39LF010-55-4C-NHE-RVL  
SST39VF040-70-4I-NHE  
SST39VF020-70-4I-NHE  
SST39VF010-70-4I-NHE  
SST39LF020-55-4C-NHE  
SST39VF020-70-4C-NHE  
SST39LF010-55-4C-NHE  
SST39VF010-70-4C-NHE  
SST39LF040-55-4C-NHE  
SST39VF040-70-4C-NHE  
SST39LF040-55-4C-NHE-A3  
SST39VF020-70-4I-NHE

SST39VF010-70-4I-NHE  
SST39VF040-70-4I-NHE  
SST39SF040-55-4C-NHE  
SST39SF020A-55-4C-NHE  
SST39SF010A-55-4C-NHE  
SST39SF040-70-4C-NHE  
SST39SF020A-70-4C-NHE  
SST39SF010A-70-4C-NHE  
SST39SF040-70-4C-NHE-PP009  
SST39SF040-55-4I-NHE  
SST39SF020A-55-4I-NHE  
SST39SF010A-55-4I-NHE  
SST39SF040-70-4I-NHE  
SST39SF020A-70-4I-NHE  
SST39SF010A-70-4I-NHE  
SST39SF010A-55-4C-NHE  
SST39SF010A-70-4C-NHE  
SST39SF010A-45-4I-NHE  
SST39SF010A-55-4I-NHE  
SST39SF010A-70-4I-NHE  
SST39SF040-55-4C-NHE  
SST39SF040-70-4C-NHE  
SST39SF040-70-4C-NHE-PP009  
SST39SF040-70-4I-NHE

**Implement MMT shipping tube  
for selected AT27xxxx, AT28xxxx  
and SST39xxxx products available  
in 32L PLCC package.**



---

A Leading Provider of Smart, Connected and Secure Embedded Control Solutions



SMART | CONNECTED | SECURE

**KSRA-15BCAH919  
CCB 4437**

# Shipping Tube Pre and Post Change

## ❑ Tube Comparison (AT27xxxx and AT28xxxx Products):

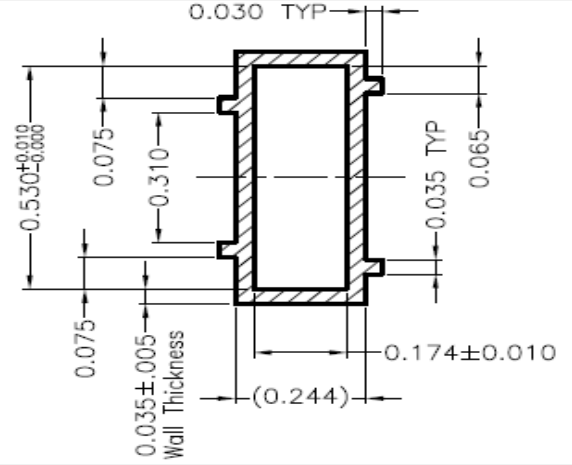
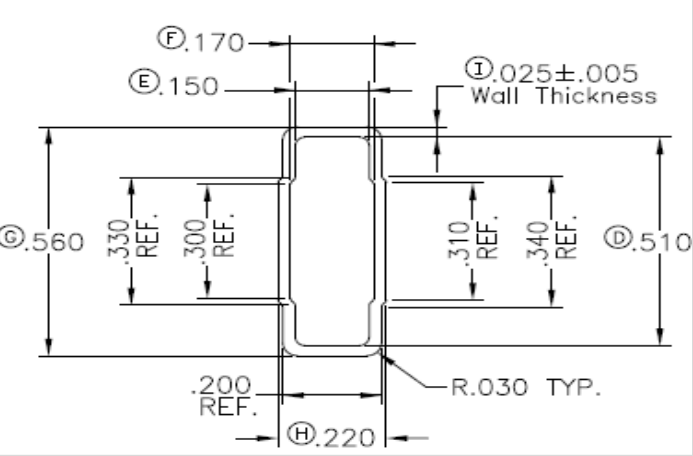
Pre change	Post change
<b>Tube Dimension</b>	
<p>Length: 20.40+/-0.10 inch            Width: 0.600+0.015/-0.005 inch            Tube Opening Length (A): 0.174 + 0.010 inch            Tube Opening Width (B): 0.530+0.010/-0.000 inch            Wall thickness (T): 0.035 + 0.005</p> <p><b>Tube Opening:</b></p> 	<p>Length: 21.70 ± 0.045 inch            Width: 0.560 ± 0.015 inch            Tube Opening Length (A): 0.170 ± 0.010 inch            Tube Opening Width (B): 0.510 ± 0.010 inch            Wall thickness (T): 0.025 ± 0.005 inch</p> <p><b>Tube Opening:</b></p> 



# Shipping Tube Pre and Post Change

## Pre change

## Post change

### Tube Photo and Illustration

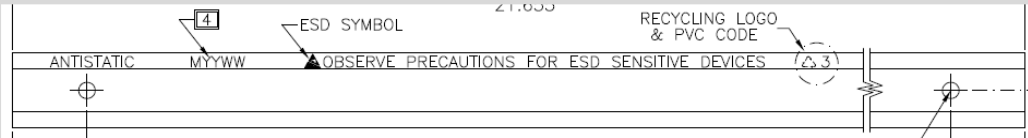
#### For AT27xxxx and AT28xxxx Products



### Tube Stopper



Blue colored stopper only on both ends



Blue and gray colored stopper



# Shipping Tube Pre and Post Change

## □ Tube Comparison (SST39xxxx products):

Pre change

Post change

### Tube Dimension

Length: 19.40+/-0.05 inch  
Width: 0.600+0.015/-0.005 inch  
Tube Opening Length (A): 0.174+0.010/-0.005 inch  
Tube Opening Width (B): 0.530+0.010/-0.000 inch  
Wall thickness (T): 0.035 ± 0.005

#### Tube Opening:

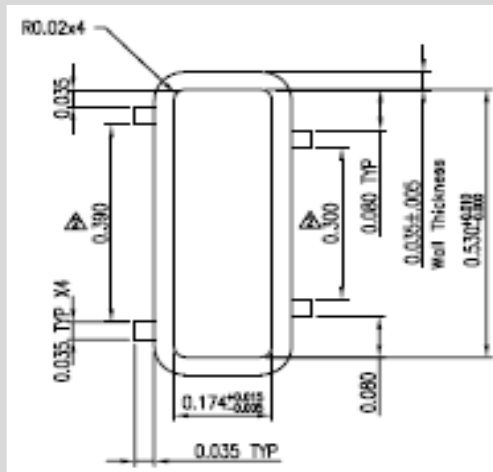

Length: 20.02 ± 0.05 inch  
Width: 0.560 ± 0.015 inch  
Tube Opening Length (A): 0.170 ± 0.010 inch  
Tube Opening Width (B): 0.510 ± 0.010 inch  
Wall thickness (T): 0.025 ± 0.005

#### Tube Opening:

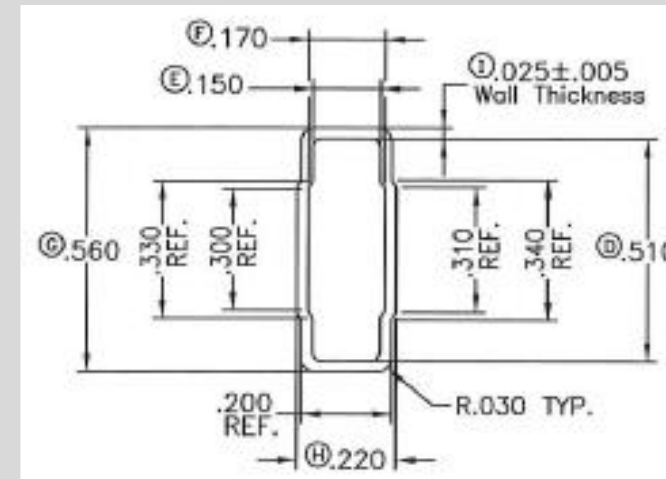

# Shipping Tube Pre and Post Change

Pre change

Post change

## Tube Photo and Illustration

For SST39xxxx products

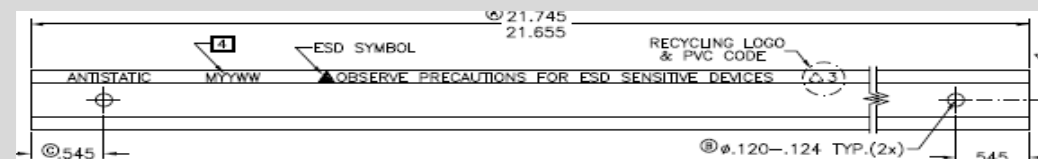
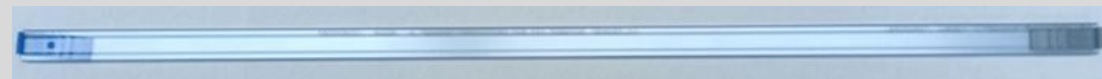
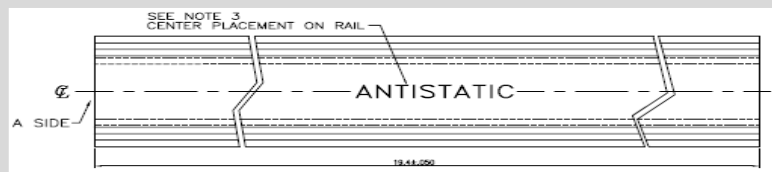

## Tube Stopper



Blue and white colored stopper



Blue and gray colored stopper

# Shipping Tube Pre and Post Change

BQM 30 units/Tube (SST39xxx products) products: Pin 1 Orientation in tube

Grey plug

Blue plug

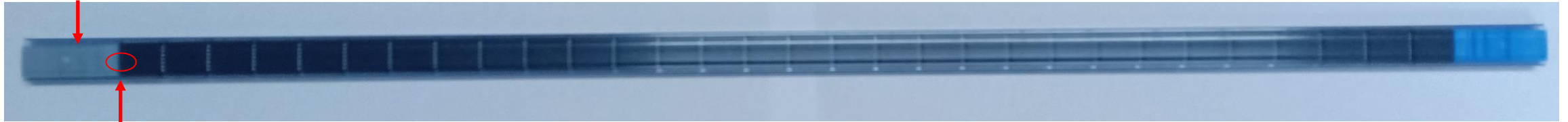

Pin#1 notch

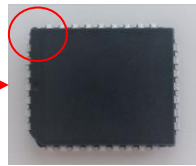

BQM 32 units/Tube (AT27xxx and AT28xxx Products): Pin 1 Orientation in tube

Grey plug

Blue plug

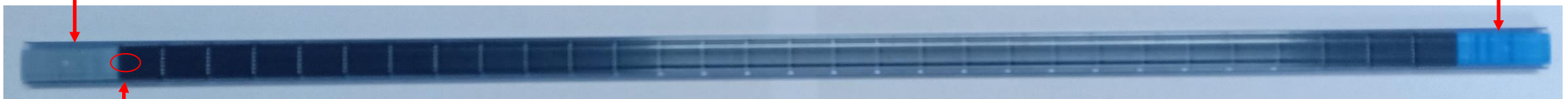

Pin#1 notch





## Product Change Notification / KSRA-15BCAH919

---

**Date:**

26-Nov-2020

**Product Category:**

Memory

**PCN Type:**

Manufacturing Change

**Notification Subject:**

CCB 4437 Final Notice: Implement MMT shipping tube for selected AT27xxxx, AT28xxxx and SST39xxxx products available in 32L PLCC package.

**Affected CPNs:**

[KSRA-15BCAH919\\_Affected\\_CPN\\_11262020.pdf](#)  
[KSRA-15BCAH919\\_Affected\\_CPN\\_11262020.csv](#)

**Notification Text:****PCN Status:**

Final notification.

**PCN Type:** Manufacturing Change

**Microchip Parts Affected:** Please open one of the icons found in the Affected CPNs section above.

NOTE: For your convenience Microchip includes identical files in two formats (.pdf and .xls).

**Description of Change:** Implement MMT shipping tube for selected AT27xxxx, AT28xxxx and SST39xxxx products available in 32L PLCC package.

**Pre Change:**

LPI shipping tube

**Post Change:**

MMT shipping tube

**Pre and Post Change Summary:**

	Pre Change	Post Change
Shipping Tube	LPI shipping tube	MMT shipping tube
	See attached photos for the pre and post changes	

**Impacts to Data Sheet:** None

**Change Impact:**None

**Reason for Change:**To improve on-time delivery performance by implementing MMT shipping tube

**Change Implementation Status:**In Progress

**Estimated First Ship Date:**

December 26, 2020 (date code: 2052)

NOTE: Please be advised that after the estimated first ship date customers may receive pre and post change parts.

**Time Table Summary:**

	November 2020				December 2020			
Workweek	45	46	47	48	49	50	51	52
Final PCN Issue Date				X				
Estimated Implementation Date								X

**Method to Identify Change:** Traceability code, shipping tube

**Qualification Report:**Not applicable

**Revision History:**November 26, 2020: Issued final notification.

The change described in this PCN does not alter Microchip’s current regulatory compliance regarding the material content of the applicable products.

**Attachments:**

[PCN\\_KSRA-15BCAH919\\_Pre and Post Change Summary.pdf](#)

Please contact your local **Microchip sales office** with questions or concerns regarding this notification.

## Terms and Conditions:

If you wish to receive Microchip PCNs via email please register for our PCN email service at our [PCN home page](#) select register then fill in the required fields. You will find instructions about registering for Microchips PCN email service in the [PCN FAQ](#) section.

If you wish to change your PCN profile, including opt out, please go to the [PCN home page](#) select login and sign into your myMicrochip account. Select a profile option from the left navigation bar and make the applicable selections.

Affected Catalog Part Numbers (CPN)

AT28C64B-15JU  
AT28HC64B-70JU  
AT28HC64B-90JU  
AT28HC64B-12JU  
AT28HC64BF-12JU  
AT28BV64B-20JU  
AT27BV256-70JU  
AT27LV256A-90JU  
AT27LV512A-90JU  
AT27BV010-90JU  
AT27LV010A-70JU  
AT27LV020A-12JU  
AT27C256R-45JU  
AT27C256R-70JU  
AT27C256R-70JU-306  
AT27C512R-45JU  
AT27C512R-70JU  
AT27C020-55JU  
AT27C020-90JU  
AT27C010-45JU  
AT27C010-70JU  
SST39LF040-55-4C-NHE  
SST39LF020-55-4C-NHE  
SST39LF010-55-4C-NHE  
SST39LF020-55-4C-NHE-RVL  
SST39LF040-55-4C-NHE-RVL  
SST39VF040-70-4C-NHE  
SST39VF020-70-4C-NHE  
SST39VF010-70-4C-NHE  
SST39VF040-70-4C-NHE-DP003  
SST39VF040-70-4C-NHE-PP013  
SST39VF040-70-4C-NHE-RVL  
SST39LF040-55-4C-NHE-A3  
SST39VF020-70-4C-NHE-RVL  
SST39LF010-55-4C-NHE-RVL  
SST39VF040-70-4I-NHE  
SST39VF020-70-4I-NHE  
SST39VF010-70-4I-NHE  
SST39SF040-55-4C-NHE  
SST39SF020A-55-4C-NHE  
SST39SF010A-55-4C-NHE  
SST39SF040-70-4C-NHE  
SST39SF020A-70-4C-NHE  
SST39SF010A-70-4C-NHE  
SST39SF040-70-4C-NHE-PP009  
SST39SF040-55-4I-NHE

SST39SF020A-55-4I-NHE  
SST39SF010A-55-4I-NHE  
SST39SF040-70-4I-NHE  
SST39SF020A-70-4I-NHE  
SST39SF010A-70-4I-NHE  
SST39SF010A-45-4I-NHE  
SST39LF010-55-4C-NHE-RVL-T  
SST39VF010-70-4C-NHE-RVL-T  
SST39VF040-70-4I-NHE-T  
SST39VF010-70-4I-NHE-T  
SST39LF020-55-4C-NHE-T  
SST39LF010-55-4C-NHE-T  
SST39LF040-55-4C-NHE-T  
SST39VF020-70-4I-NHE-T  
SST39SF040-55-4C-NHE-T  
SST39SF020A-55-4C-NHE-T  
SST39SF010A-55-4C-NHE-T  
SST39SF040-70-4C-NHE-T  
SST39SF020A-70-4C-NHE-T  
SST39SF010A-70-4C-NHE-T  
SST39SF040-55-4I-NHE-T  
SST39SF020A-55-4I-NHE-T  
SST39SF010A-55-4I-NHE-T  
SST39SF040-70-4I-NHE-T  
SST39SF020A-70-4I-NHE-T  
SST39SF010A-70-4I-NHE-T  
SST39SF010A-45-4I-NHE-T



**Implement MMT shipping tube  
for selected AT27xxxx, AT28xxxx  
and SST39xxxx products available  
in 32L PLCC package.**



---

A Leading Provider of Smart, Connected and Secure Embedded Control Solutions



SMART | CONNECTED | SECURE

**KSRA-15BCAH919  
CCB 4437**

# Shipping Tube Pre and Post Change

## ❑ Tube Comparison (AT27xxxx and AT28xxxx Products):

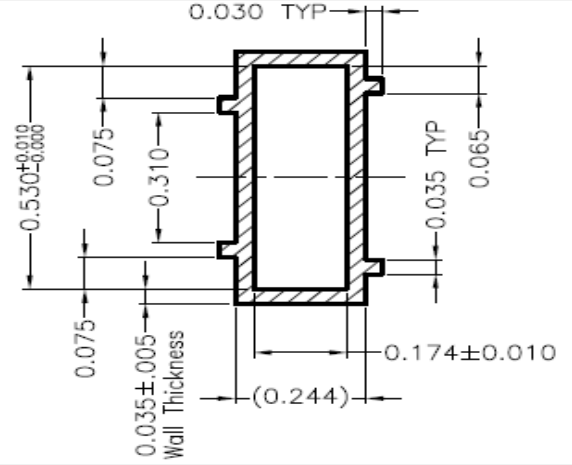
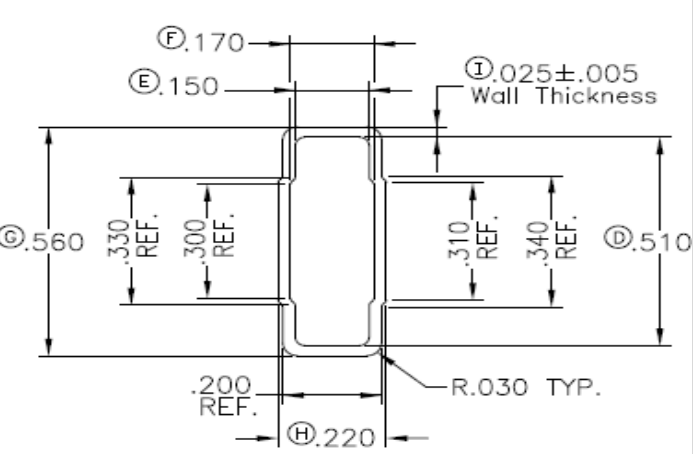

Pre change	Post change
<b>Tube Dimension</b>	
<p>Length: 20.40+/-0.10 inch            Width: 0.600+0.015/-0.005 inch            Tube Opening Length (A): 0.174 + 0.010 inch            Tube Opening Width (B): 0.530+0.010/-0.000 inch            Wall thickness (T): 0.035 + 0.005</p> <p><b>Tube Opening:</b></p> 	<p>Length: 21.70 ± 0.045 inch            Width: 0.560 ± 0.015 inch            Tube Opening Length (A): 0.170 ± 0.010 inch            Tube Opening Width (B): 0.510 ± 0.010 inch            Wall thickness (T): 0.025 ± 0.005 inch</p> <p><b>Tube Opening:</b></p> 

# Shipping Tube Pre and Post Change

Pre change	Post change
------------	-------------

## Tube Photo and Illustration

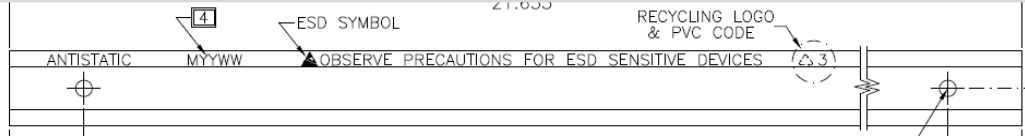
### For AT27xxxx and AT28xxxx Products



## Tube Stopper



Blue colored stopper only on both ends



Blue and gray colored stopper

# Shipping Tube Pre and Post Change

## ☐ Tube Comparison (SST39xxxx products):

Pre change

Post change

### Tube Dimension

Length: 19.40+/-0.05 inch  
 Width: 0.600+0.015/-0.005 inch  
 Tube Opening Length (A): 0.174+0.010/-0.005 inch  
 Tube Opening Width (B): 0.530+0.010/-0.000 inch  
 Wall thickness (T): 0.035 ± 0.005

#### Tube Opening:

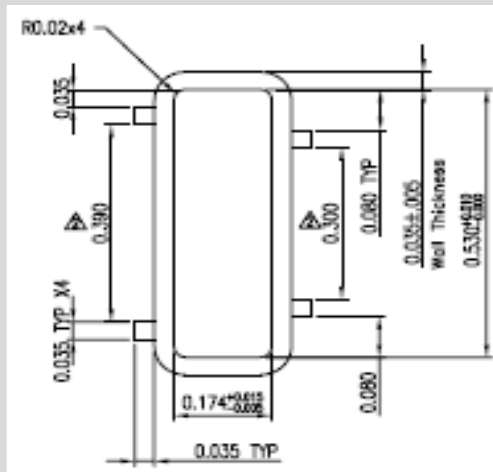

Length: 20.02 ± 0.05 inch  
 Width: 0.560 ± 0.015 inch  
 Tube Opening Length (A): 0.170 ± 0.010 inch  
 Tube Opening Width (B): 0.510 ± 0.010 inch  
 Wall thickness (T): 0.025 ± 0.005 inch

#### Tube Opening:

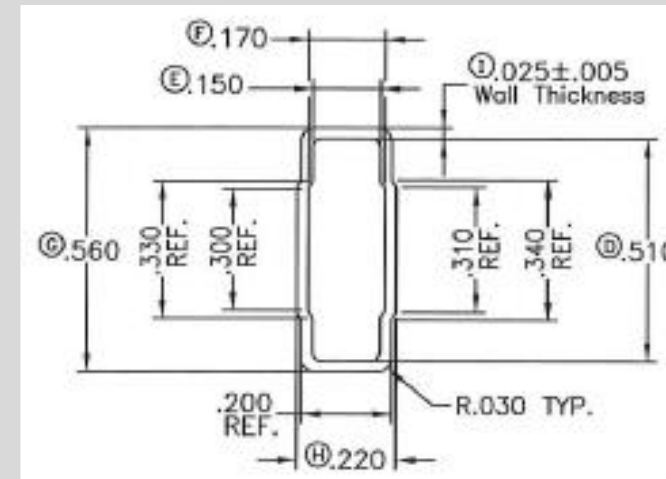

# Shipping Tube Pre and Post Change

Pre change

Post change

## Tube Photo and Illustration

For SST39xxxx products

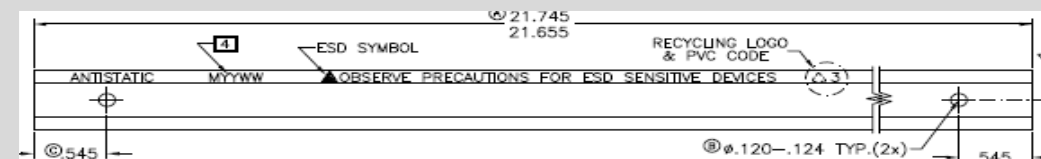
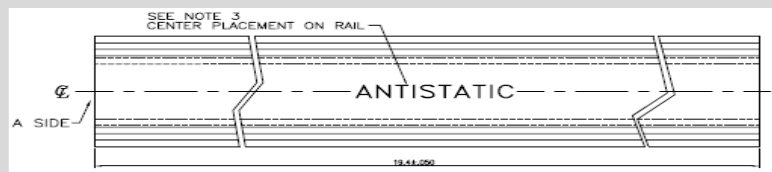

## Tube Stopper



Blue and white colored stopper



Blue and gray colored stopper

# Shipping Tube Pre and Post Change

BQM 30 units/Tube (SST39xxx products) products: Pin 1 Orientation in tube

Grey plug

Blue plug

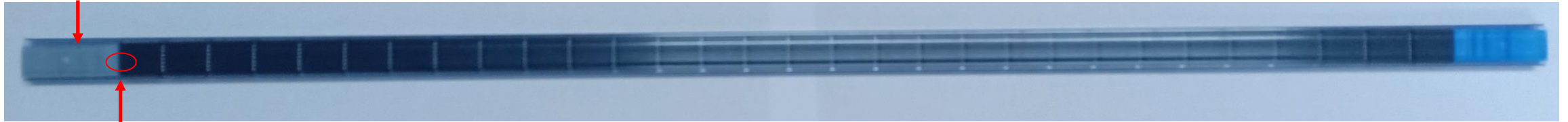

Pin#1 notch

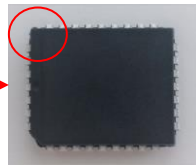

BQM 32 units/Tube (AT27xxx and AT28xxx Products): Pin 1 Orientation in tube

Grey plug

Blue plug

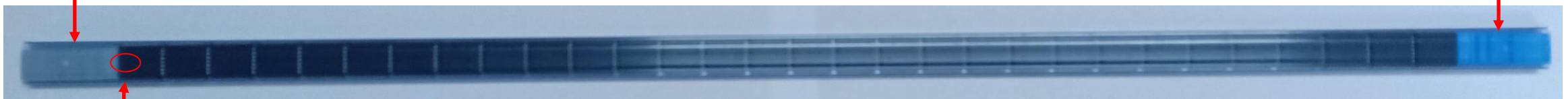

Pin#1 notch

