



TE Internal #: AKA034N00730255000

Standard Circular Connectors, Cable-to-Cable, Signal, Cable Mount (Free-Hanging), Electrodeposited Nickel, Zinc Alloy, PBT, 23 Shell Size, Shielded

[View on TE.com >](#)

Connectors > Circular Connectors > Standard Circular Connectors



Connector System: **Cable-to-Cable**

Sealable: **No**

Circuit Application: **Signal**

Connector Mounting Type: **Cable Mount (Free-Hanging)**

Shell Plating Material: **Electrodeposited Nickel**

Features

Product Type Features

Product Type	Connector
Connector System	Cable-to-Cable
Sealable	No
Shell Type	Metal

Electrical Characteristics

Operating Voltage	125 VAC
-------------------	---------

Body Features

Environmental Protection	IP67
Shell Plating Material	Electrodeposited Nickel
Shell Base Material	Zinc Alloy
Circular Connector Insulation Material Type	PBT

Mechanical Attachment

Mating Retention Type	Speedtec (Triple Start Threaded)
Connector Mounting Type	Cable Mount (Free-Hanging)



Housing Features

Circular Connector Shell Size	23
Alignment Keyed	Uncoded

Dimensions

Cable Diameter Range	9 – 14.3 mm [.35 – .56 in]
----------------------	----------------------------

Usage Conditions

Operating Temperature Range	-20 – 130 °C [-4 – 266 °F]
-----------------------------	----------------------------

Operation/Application

Durability Rating	500 Cycles
Circuit Application	Signal
Shielded	Yes

Industry Standards

UL Flammability Rating	UL 94V-0
Approved Standards	UL

Product Compliance

[For compliance documentation, visit the product page on TE.com>](#)

EU RoHS Directive 2011/65/EU	Compliant with Exemptions
EU ELV Directive 2000/53/EC	Compliant with Exemptions
China RoHS 2 Directive MIIT Order No 32, 2016	Restricted Materials Above Threshold
EU REACH Regulation (EC) No. 1907/2006	Current ECHA Candidate List: JUN 2020 (209) Candidate List Declared Against: JUN 2020 (209) SVHC > Threshold: Pb (3.5% in Component) Article Safe Usage Statements: Do not eat, drink or smoke when using this product. Wash thoroughly after handling. Recycle if possible and dispose of the article by following all applicable governmental regulations relevant to your geographic location.
Halogen Content	Not Yet Reviewed for halogen content
Solder Process Capability	Not reviewed for solder process capability

Product Compliance Disclaimer

This information is provided based on reasonable inquiry of our suppliers and represents our current actual knowledge based on the information they provided. This information is subject to change. The part numbers that TE has identified as EU RoHS compliant have a maximum concentration of 0.1% by weight in homogenous materials for lead, hexavalent chromium, mercury, PBB, PBDE, DBP, BBP, DEHP, DIBP, and 0.01% for cadmium, or qualify for an exemption to these limits as defined in the Annexes of Directive 2011/65/EU (RoHS2). Finished electrical and electronic equipment products will be CE marked as required by Directive 2011/65/EU. Components may not be CE marked. Additionally, the part

numbers that TE has identified as EU ELV compliant have a maximum concentration of 0.1% by weight in homogenous materials for lead, hexavalent chromium, and mercury, and 0.01% for cadmium, or qualify for an exemption to these limits as defined in the Annexes of Directive 2000/53/EC (ELV). Regarding the REACH Regulation, the information TE provides on SVHC in articles for this part number is based on the latest European Chemicals Agency (ECHA) 'Guidance on requirements for substances in articles' posted at this URL: <https://echa.europa.eu/guidance-documents/guidance-on-reach>

Compatible Parts



TE Part # ASA035N00730266000
623 PLUG

TE Part # C0-0235-000-000
DIGITAL CRIMPING TOOL, SMALL

TE Part # C0-0101-000-000
CRIMPING TOOL SMALL WITH POSITIONER

Customers Also Bought



TE Part #325803-1
AMPOWER TERMINAL 1 STUD HOLE



TE Part #6609987-4
CORCOM SRB SERIES IEC FILTERED INLETS



TE Part #165412
PLASTI-GRIP 4-6MM RING M4



TE Part #1-1452054-1
TIMER, CONNECTOR HOUSING

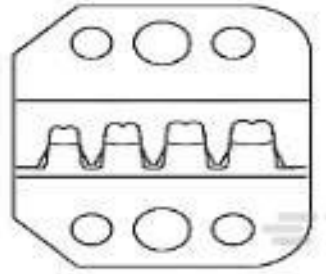

TE Part #58707-2
PROCRIMP MINI-U-MNL2 DIE



TE Part #AKA021N00750200000
623 EXTENSION, SPEEDTEC-READY



TE Part #ASA035N00730266000
623 PLUG



TE Part #AKA035N00730255000
623 EXTENSION, SPEEDTEC-READY



TE Part #90276-2
HHHT PIDG PG FASTON 12-10

Documents

[CAD Files](#)



3D PDF

3D

Customer View Model

[ENG_CVM_CVM_AKA034N00730255000_A.2d_dxf.zip](#)

English

Customer View Model

[ENG_CVM_CVM_AKA034N00730255000_A.3d_igs.zip](#)

English

Customer View Model

[ENG_CVM_CVM_AKA034N00730255000_A.3d_stp.zip](#)

English

By downloading the CAD file I accept and agree to the [Terms and Conditions](#) of use.

Datasheets & Catalog Pages

[AKA034N00730255000](#)

English

Instruction Sheets

[Instruction Sheet \(non U.S.\)](#)

English