

Specification

- Part No. : MA251.A.BI.001
- Product Name : Sentinel Adhesive Mount 2*LTE MIMO Antenna
- Feature : Ideal for IoT / M2M / Automotive Applications
Smallest High Performance MIMO
2 x LTE MIMO 1&2 Antennas
4G Allowing Fallback to 3G & 2G
IP67 Waterproof
High Efficiency
Low Profile Housing – Only 14mm in Height
2m CFD-200 and RG-174 Cables
SMA(M) Connectors
Dimensions: 139*76*14mm
RoHS & REACH Compliant



1. Introduction

The MA251 Sentinel 2in1 adhesive mount 4G 2*LTE MIMO antenna is an omnidirectional, fully IP67 waterproof external M2M antenna for use in telematics, transportation and remote monitoring applications worldwide. It is designed to be mounted directly on glass or plastic in the interior of vehicles.

It is the smallest high performance solution in the market, 50% smaller than the previous generation, with higher efficiency and wider bandwidth to cover emerging LTE bands. Its performance is comparable with much larger permanent roof mount antennas and now offers a convenient and economical alternative in-cabin mounting solution.

Typical applications include;

- HD video over LTE
- First Responder and Emergency Services
- Automotive vehicle tracking
- Telematics

It is mounted via high quality, first tier automotive approved, 3M adhesive.

In-house world leading dielectric ceramic antenna technology inside allows for smaller size antennas without loss in efficiency. It delivers powerful 2*2 MIMO antenna technology for worldwide 4G LTE bands at 700MHz/ 800MHz/ 1700MHz/ 1800MHz /2300MHz /2600MHz, while allowing fallback to all common worldwide 3G and 2G frequency bands.

4G wireless applications demand high speed data uplink and downlink. High efficiency and high gain MIMO antennas are necessary to achieve the required signal to noise ratio and throughput required to solve these challenges. Taoglas also takes care to have high isolation between the two MIMO antennas to prevent self-interference. Low loss cables are used to keep efficiency high over long cable lengths.

The IP67 waterproof housing measures just 139*76*14mm with 3M foam adhesive. The antenna can be mounted internally or externally on a vehicle. Both MIMO 1 and MIMO 2 coaxial cables are 2m low loss CFD-200 with SMA(M) connectors.

Customized cable and connector versions are also available. The antenna also comes in a 2in1 LTE/GNSS or a single LTE only variant. Contact your regional Taoglas sales office for support.

2. Specification Table

4G/3G/2G MIMO 1 Antenna								
Frequency (MHz)		LTE700	GSM850	GSM900	DCS	PCS	UMTS1	LTE2600
		698~803	824~894	880~960	1710~1880	1850~1990	1920~2170	2490~2690
Efficiency (%)								
In free space	30cm	41.77	58.99	60.75	66.44	76.05	66.91	56.87
	1M	39.89	56.33	58.01	60.59	69.53	61.59	51.86
	2M	37.22	52.23	52.91	54.49	61.97	54.72	44.70
	3M	34.74	48.42	49.06	48.24	54.54	47.85	37.97
	5M	29.75	40.81	41.20	37.70	42.12	37.06	29.04
On 2mm ABS base	30cm	41.14	54.04	57.58	66.82	76.00	66.82	55.38
	1M	39.29	51.61	54.99	60.94	69.48	61.51	50.51
	2M	36.67	47.83	50.15	54.81	61.93	54.64	43.54
	3M	34.22	44.34	46.52	48.52	54.49	47.79	36.98
	5M	29.32	37.37	39.06	37.92	42.08	37.01	28.29
On the glass base	30cm	43.33	55.50	58.33	63.40	63.83	55.87	56.49
	1M	41.38	53.00	55.71	57.82	58.35	51.42	51.52
	2M	38.62	49.13	50.81	52.03	52.01	45.69	44.42
	3M	36.04	45.54	47.12	46.04	45.77	39.95	37.74
	5M	30.91	38.38	39.57	36.00	35.35	30.95	28.86
Average Gain(dBi)								
In free space	30cm	-3.87	-2.29	-2.17	-1.81	-1.19	-1.81	-2.48
	1M	-4.07	-2.49	-2.37	-2.21	-1.58	-2.17	-2.88
	2M	-4.37	-2.82	-2.77	-2.66	-2.08	-2.68	-3.53
	3M	-4.67	-3.15	-3.10	-3.20	-2.63	-3.27	-4.23
	5M	-5.34	-3.89	-3.85	-4.26	-3.76	-4.37	-5.40
On the 2mm ABS base	30cm	-3.89	-2.68	-2.41	-1.78	-1.19	-1.83	-2.60
	1M	-4.09	-2.88	-2.61	-2.18	-1.58	-2.18	-3.00
	2M	-4.39	-3.21	-3.01	-2.64	-2.08	-2.70	-3.64
	3M	-4.69	-3.54	-3.33	-3.17	-2.64	-3.28	-4.35
	5M	-5.36	-4.28	-4.09	-4.24	-3.76	-4.39	-5.51
On the glass base	30cm	-3.65	-2.56	-2.34	-1.99	-1.95	-2.60	-2.50
	1M	-3.85	-2.76	-2.54	-2.39	-2.34	-2.95	-2.90
	2M	-4.15	-3.09	-2.94	-2.84	-2.84	-3.47	-3.54
	3M	-4.45	-3.42	-3.27	-3.38	-3.40	-4.05	-4.25
	5M	-5.12	-4.16	-4.03	-4.44	-4.52	-5.16	-5.41
Peak Gain(dBi)								
In free space	30cm	1.22	1.89	2.73	4.69	4.69	4.27	4.15
	1M	1.02	1.69	2.53	4.29	4.29	3.87	3.75
	2M	0.72	1.29	2.13	3.79	3.79	3.37	3.05
	3M	0.42	0.99	1.73	3.29	3.29	2.87	2.35
	5M	-0.28	0.19	1.03	2.19	2.19	1.67	1.15
On the 2mm ABS base	30cm	0.76	1.57	1.79	3.68	3.68	3.22	3.24
	1M	0.56	1.37	1.59	3.28	3.28	2.86	2.84
	2M	0.26	0.97	1.19	2.78	2.78	2.36	2.14
	3M	-0.04	0.67	0.89	2.28	2.28	1.82	1.44
	5M	-0.74	-0.13	0.09	1.18	1.18	0.66	0.24
On glass base	30cm	1.86	1.94	2.06	3.10	2.90	2.90	3.66
	1M	1.66	1.74	1.86	2.70	2.50	2.50	3.26
	2M	1.36	1.44	1.46	2.30	2.00	2.00	2.56
	3M	1.06	1.14	1.06	1.70	1.40	1.40	1.86
	5M	0.46	0.34	0.36	0.70	0.30	0.30	0.75

4G/3G/2G MIMO 2 Antenna								
Frequency (MHz)		LTE700	GSM850	GSM900	DCS	PCS	UMTS1	LTE2600
		698~803	824~894	880~960	1710~1880	1850~1990	1920~2170	2490~2690
Efficiency (%)								
In free space	30cm	46.24	33.45	35.37	54.05	57.08	51.87	67.48
	1M	44.16	31.95	33.78	49.29	52.17	47.71	61.55
	2M	41.21	29.61	30.81	44.42	46.50	42.38	53.09
	3M	38.46	27.44	28.56	39.27	40.93	37.07	45.10
	5M	33.09	23.13	24.00	30.73	31.59	28.70	34.48
On 2mm ABS base	30cm	50.50	40.14	42.93	53.67	56.84	53.32	66.89
	1M	48.23	38.33	41.00	48.95	51.96	49.05	61.01
	2M	45.01	35.53	37.39	44.10	46.31	43.57	52.61
	3M	42.01	32.93	34.66	39.00	40.76	38.10	44.68
	5M	36.10	27.75	29.12	30.51	31.46	29.51	34.17
On glass base	30cm	48.41	37.93	39.94	54.71	61.77	61.21	66.66
	1M	46.24	36.22	38.14	49.90	56.48	56.36	60.79
	2M	43.15	33.57	34.78	44.97	50.34	50.04	52.42
	3M	40.27	31.11	32.25	39.76	44.28	43.76	44.51
	5M	34.63	26.22	27.09	31.11	34.18	33.90	34.04
Average Gain(dBi)								
In free space	30cm	-3.54	-4.77	-4.51	-2.69	-2.46	-2.89	-1.71
	1M	-3.74	-4.97	-4.71	-3.09	-2.84	-3.24	-2.11
	2M	-4.04	-5.30	-5.11	-3.55	-3.34	-3.76	-2.75
	3M	-4.34	-5.63	-5.44	-4.08	-3.90	-4.34	-3.46
	5M	-5.01	-6.37	-6.20	-5.15	-5.02	-5.45	-4.63
On 2mm ABS base	30cm	-3.08	-3.98	-3.67	-2.72	-2.47	-2.76	-1.75
	1M	-3.28	-4.18	-3.87	-3.12	-2.86	-3.11	-2.15
	2M	-3.58	-4.51	-4.27	-3.57	-3.36	-3.63	-2.79
	3M	-3.88	-4.83	-4.60	-4.11	-3.91	-4.21	-3.50
	5M	-4.55	-5.58	-5.36	-5.17	-5.04	-5.32	-4.67
On the glass base	30cm	-3.31	-4.22	-3.99	-2.64	-2.11	-2.14	-1.77
	1M	-3.51	-4.42	-4.19	-3.04	-2.50	-2.50	-2.17
	2M	-3.81	-4.75	-4.59	-3.49	-3.00	-3.02	-2.82
	3M	-4.11	-5.08	-4.92	-4.03	-3.55	-3.60	-3.52
	5M	-4.77	-5.82	-5.67	-5.09	-4.67	-4.71	-4.69
Peak Gain(dBi)								
In free space	30cm	3.75	1.34	1.45	4.53	3.17	3.32	4.17
	1M	3.55	1.14	1.25	4.13	2.77	2.92	3.77
	2M	3.25	0.74	0.85	3.73	2.27	2.42	3.07
	3M	2.95	0.44	0.54	3.23	1.77	1.82	2.37
	5M	2.35	-0.31	-0.25	2.13	1.77	0.72	1.17
On 2mm ABS base	30cm	3.78	2.32	2.39	3.45	4.37	4.37	5.63
	1M	3.58	2.12	2.19	3.05	3.97	3.97	5.23
	2M	3.28	1.74	1.79	2.55	3.47	3.47	4.53
	3M	2.98	1.42	1.49	2.05	2.87	2.87	3.73
	5M	2.38	0.72	0.72	0.95	1.77	1.77	2.63
On glass base	30cm	3.35	1.54	2.10	3.15	3.86	3.86	3.75
	1M	3.15	1.34	1.90	2.75	3.46	3.46	3.35
	2M	2.85	1.03	1.50	2.35	2.96	2.96	2.71
	3M	2.55	0.64	1.10	1.85	2.36	2.36	2.01
	5M	1.95	0.64	0.40	0.75	1.26	1.26	0.91
Envelope Correlation Coefficient				All Bands < 0.3				
Impedance				50Ω				
Polarization				Linear				
Return Loss				< -6dB				
Input Power				5W				

MECHANICAL	
Antenna Dimensions	139.27*76.27*14mm
Housing	ABS
Waterproof	IP67
Connector	SMA(M) ST
Cable type	LTE: CFD-200
Cable length	2000mm
Weight	235g
ENVIRONMENTAL	
Operation Temperature	-40°C to 85°C
Storage Temperature	-40°C to 85°C
Humidity	Non-condensing 65°C 95% RH

3. Antenna Characteristics

3.1. LTE Characteristics

3.1.1. Test Setup



In free space

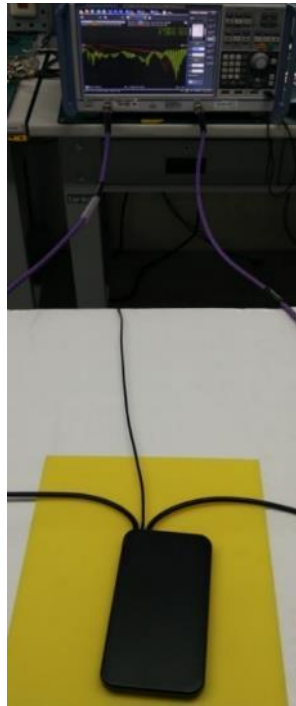

On 2mm ABS

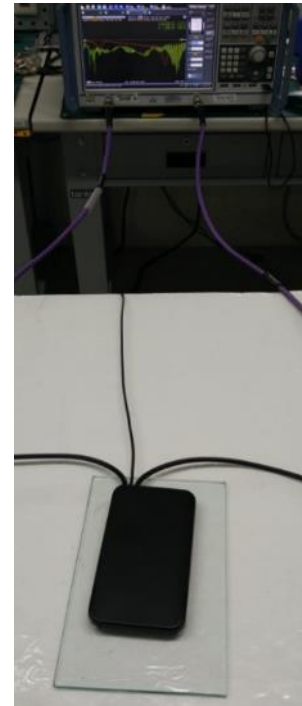

On glass

3.1.2. Return loss (MIMO 1)

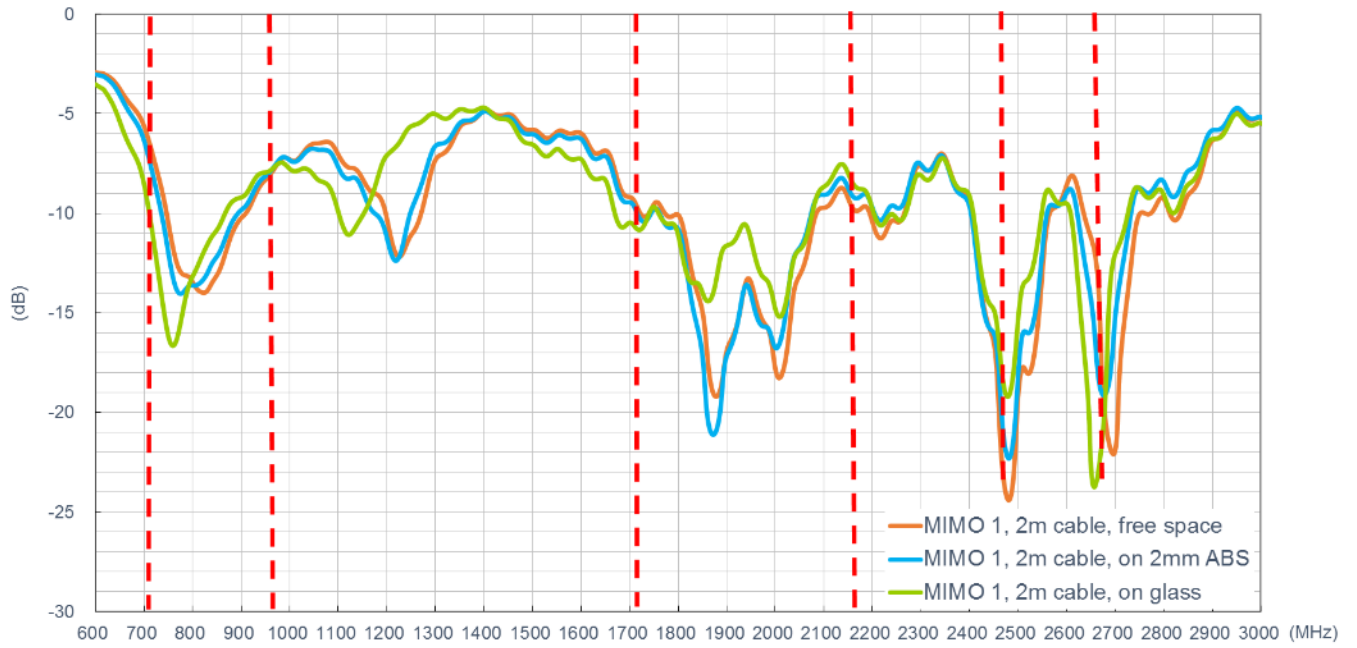

3.1.3. Return loss (MIMO 2)

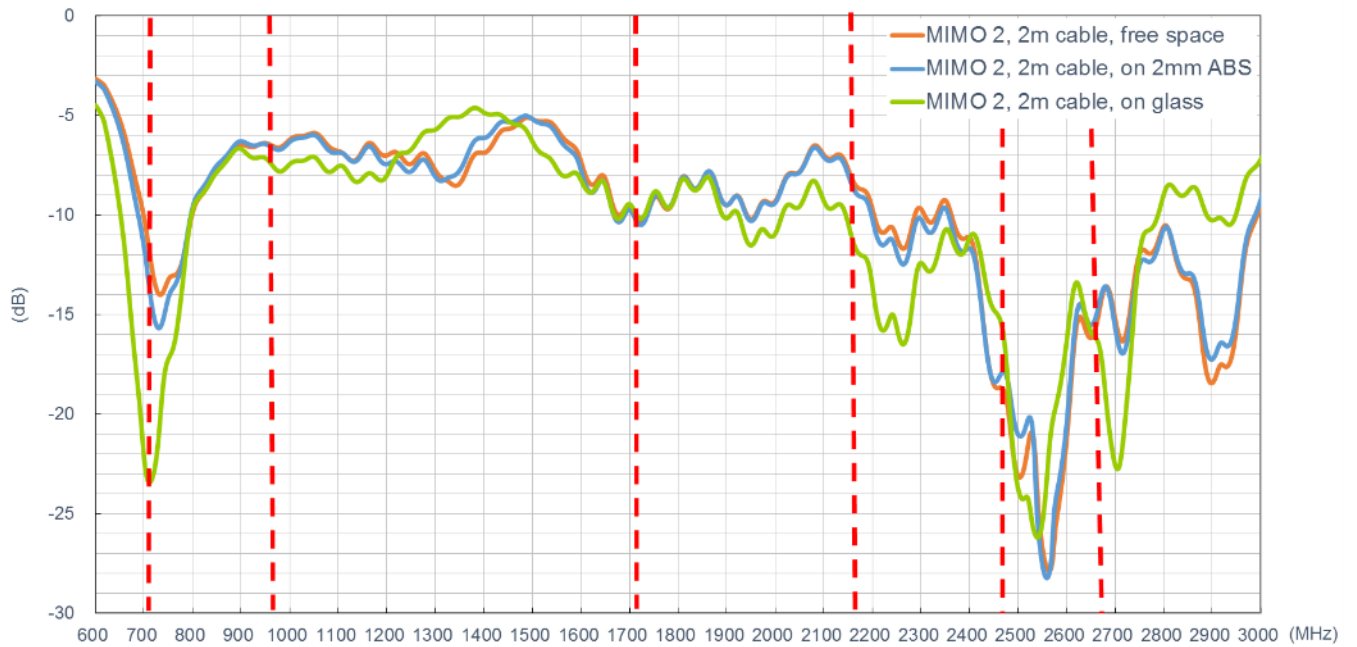

3.1.4. Isolation

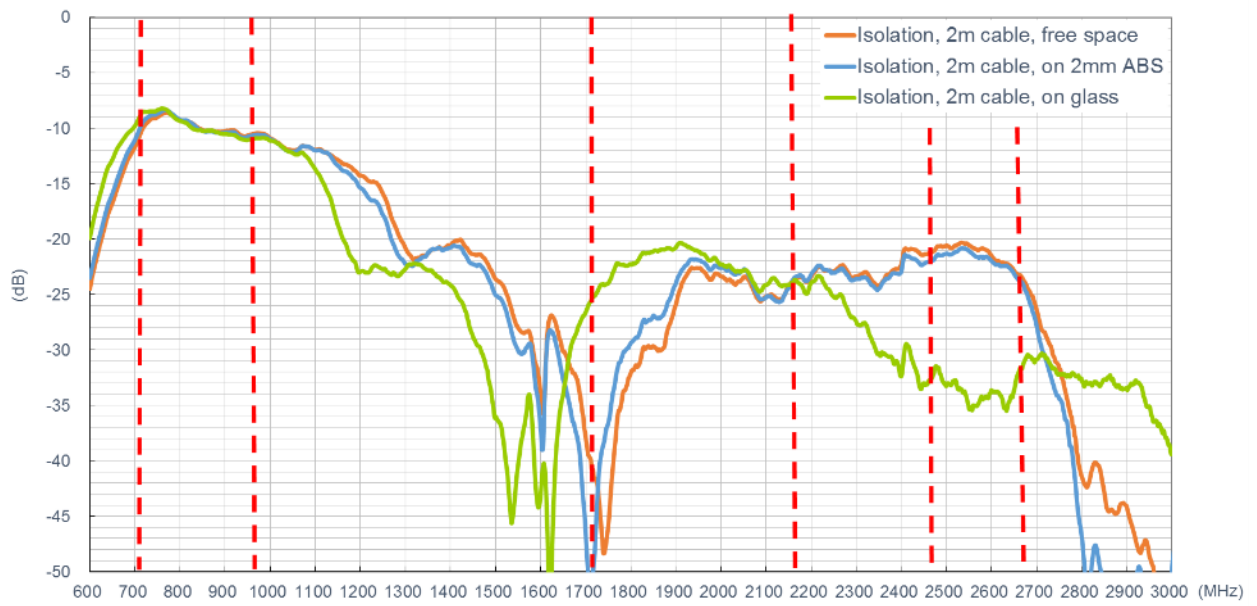

3.1.5. Efficiency (MIMO 1)

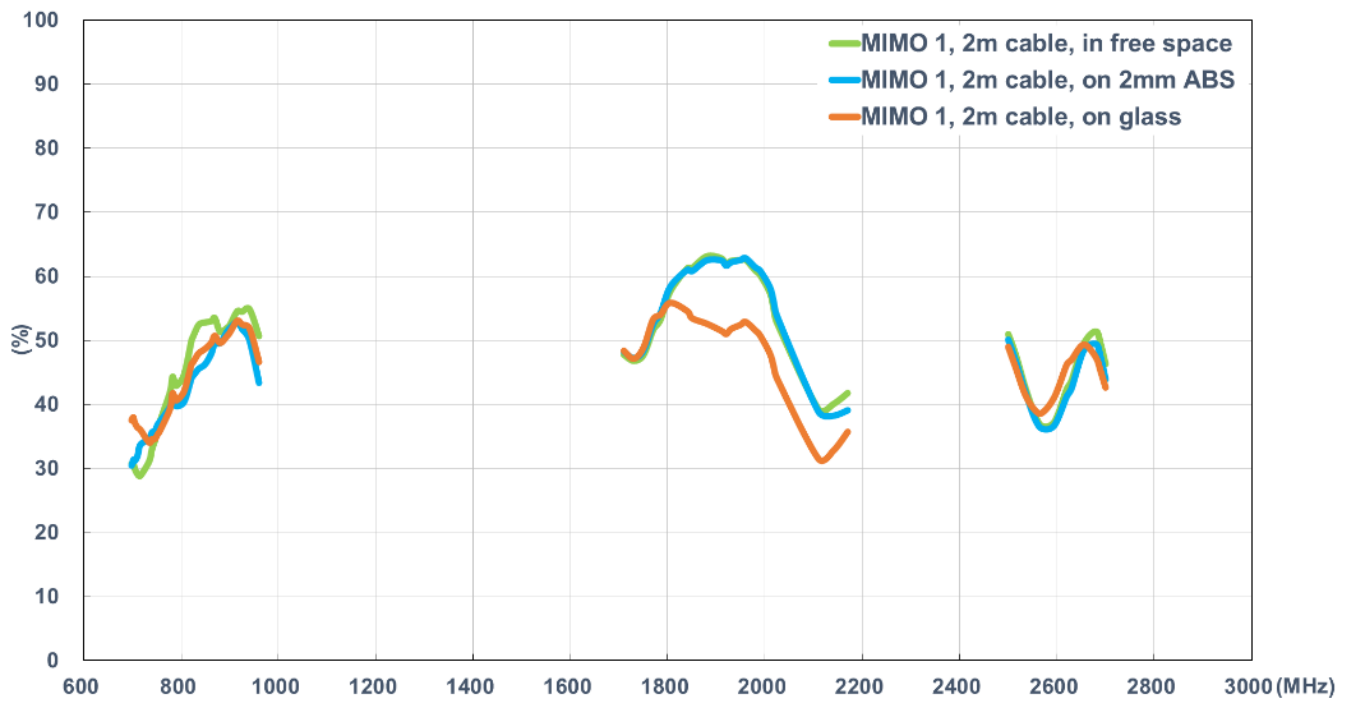

3.1.6. Efficiency (MIMO 2)

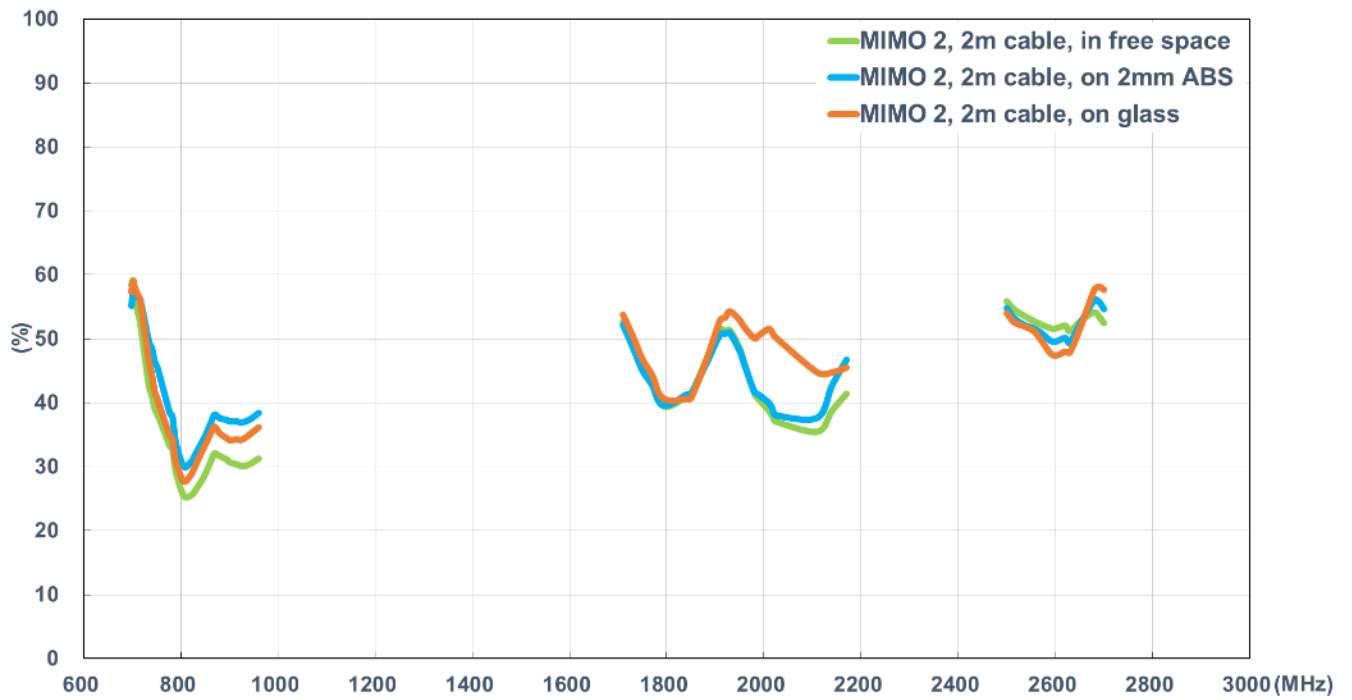

3.1.7. Average Gain (MIMO 1)

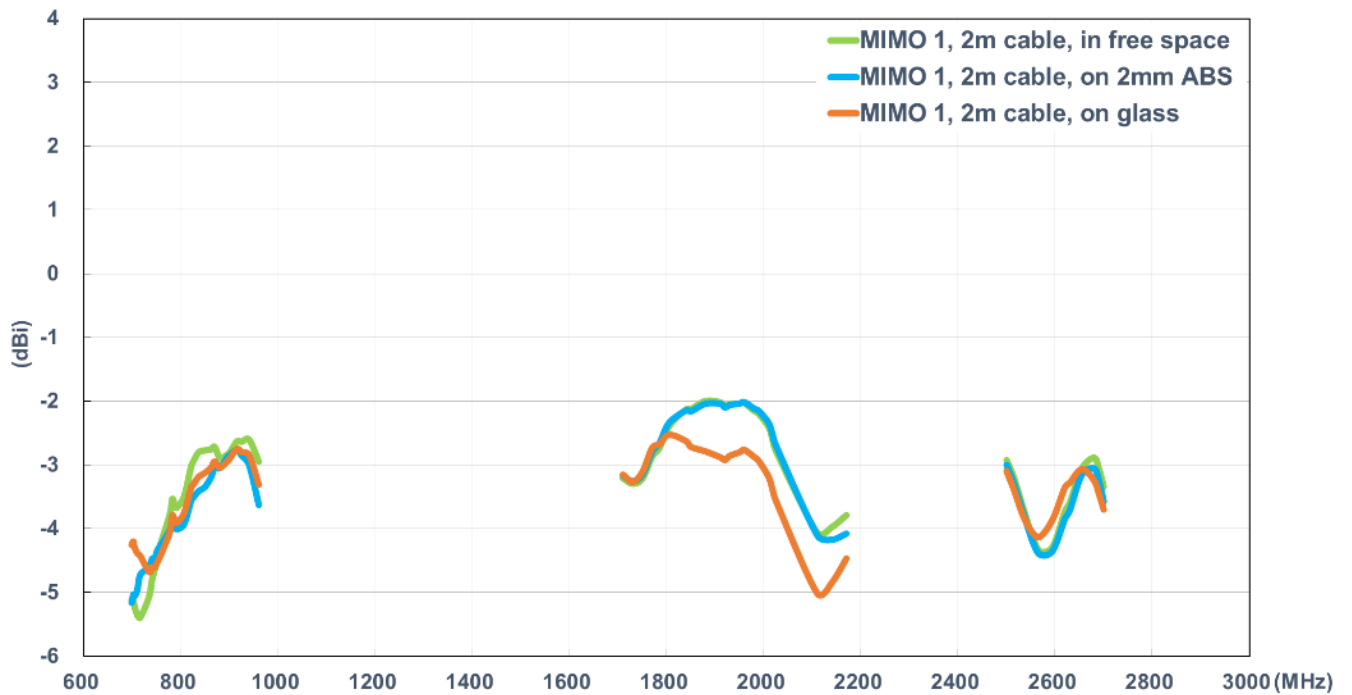

3.1.8. Average Gain (MIMO 2)

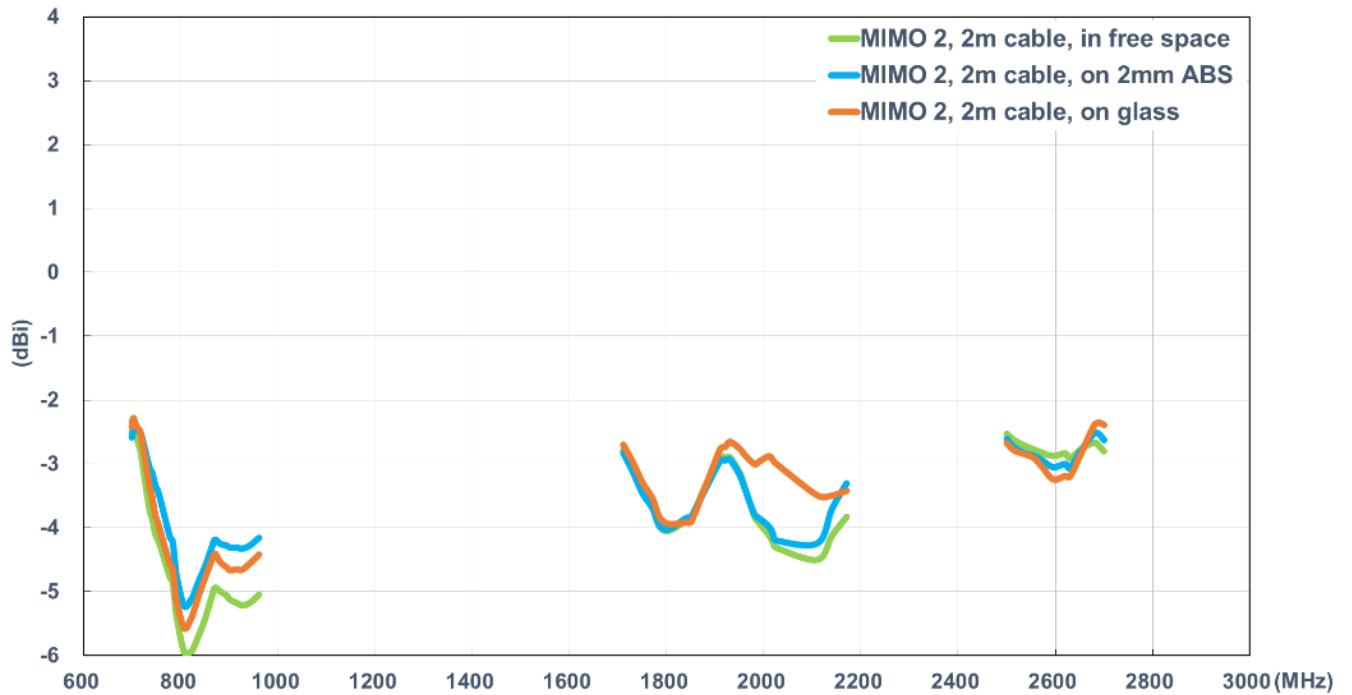

3.1.9. Peak Gain (MIMO 1)

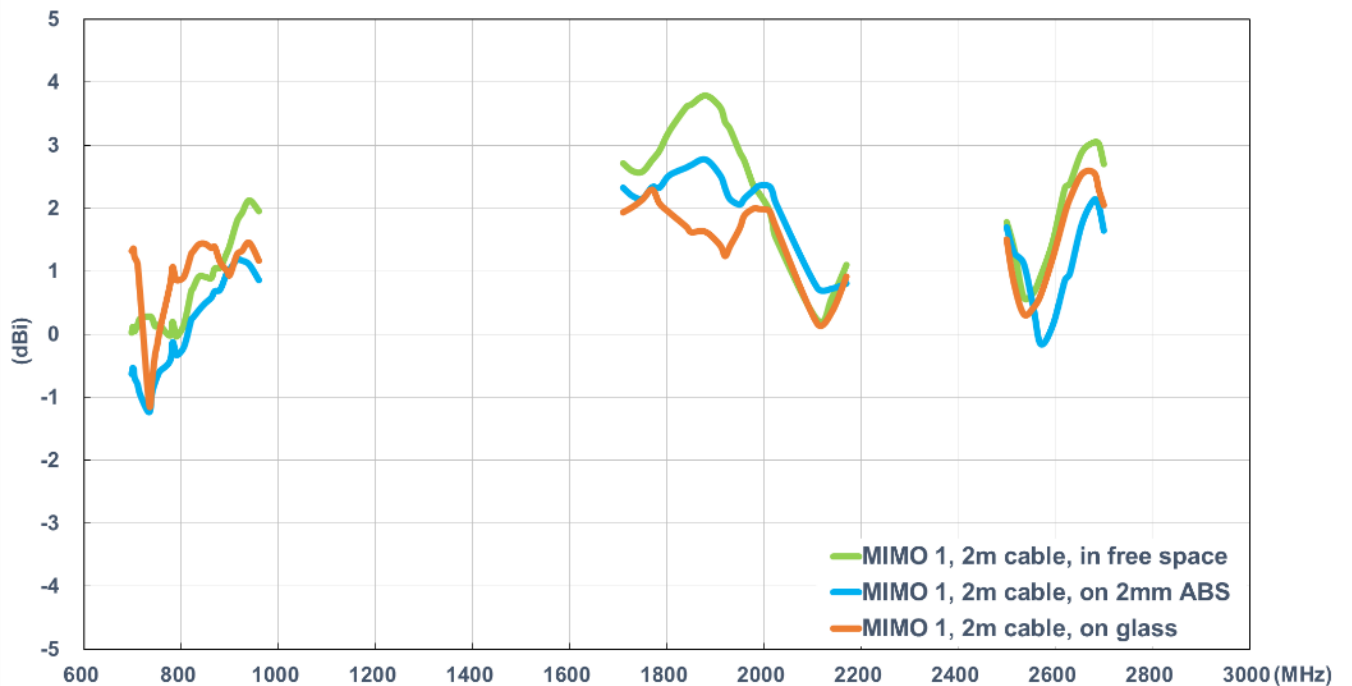

3.1.10. Peak Gain (MIMO 2)

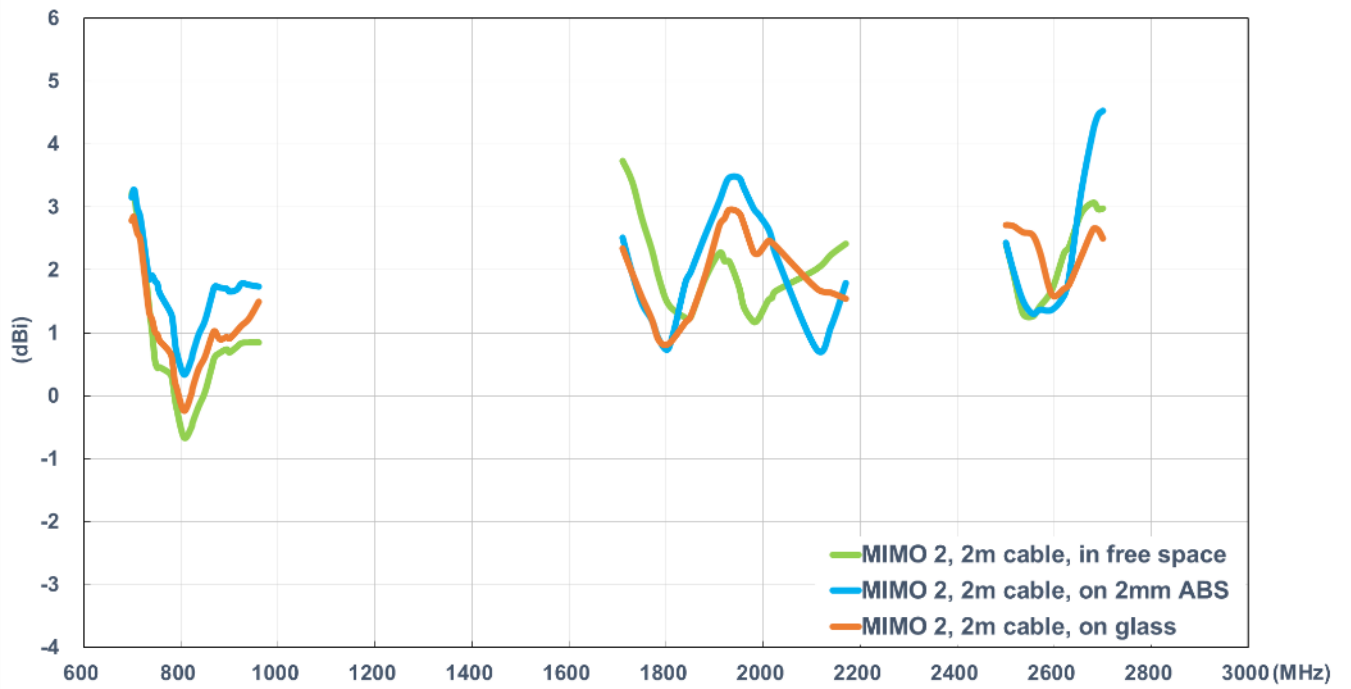

3.1.11. Envelope Correlation Coefficient (ECC)

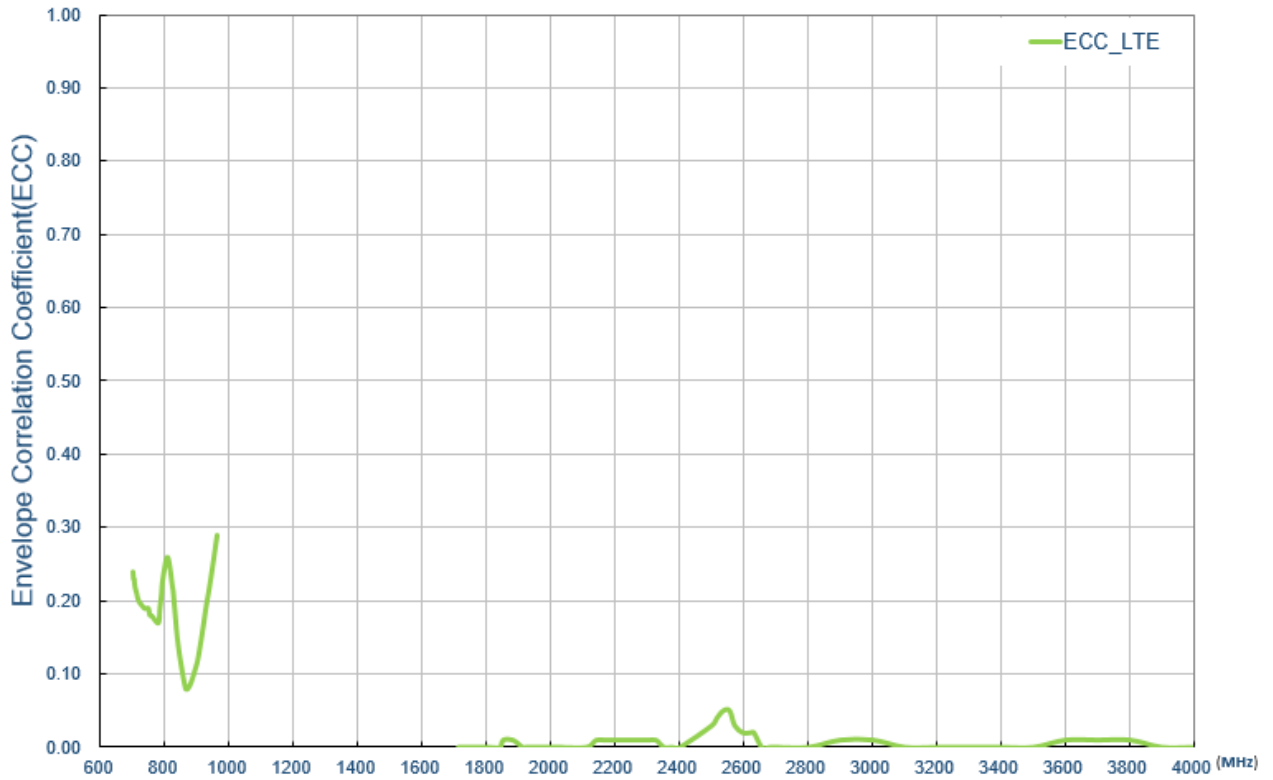

3.2. 2D Radiation Pattern

3.2.1. Test Setup

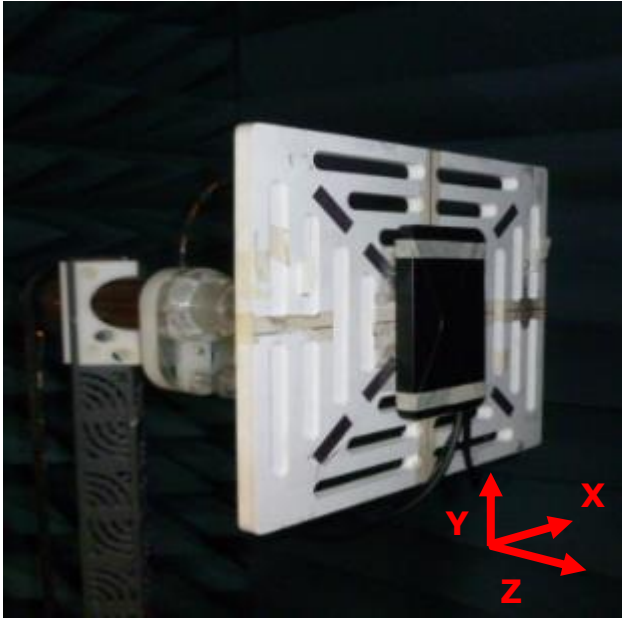

In free space

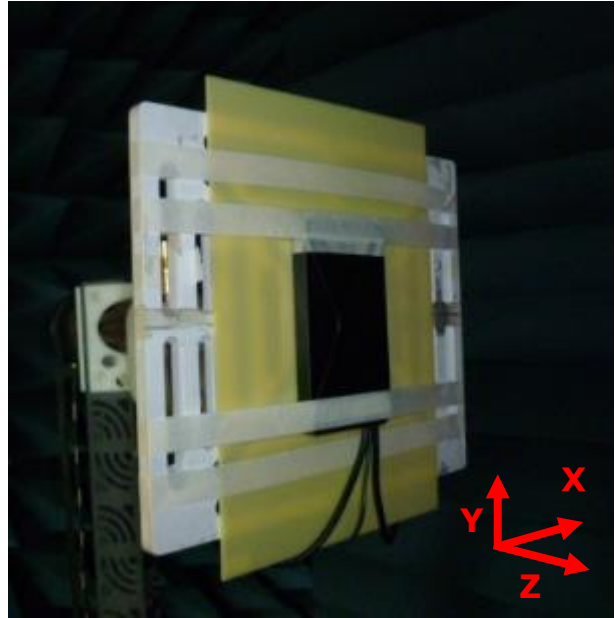

On 2mm ABS

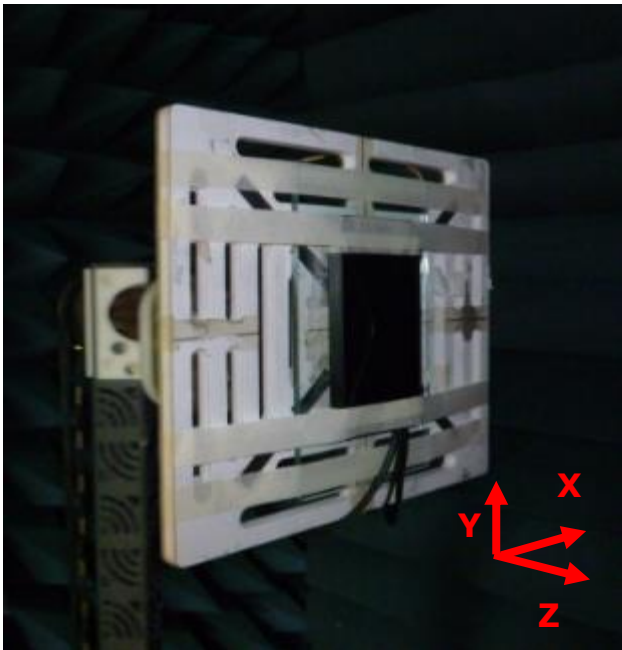

On glass base

3.2.2. LTE with 2M cable length in free space (MIMO 1)

XY Plane

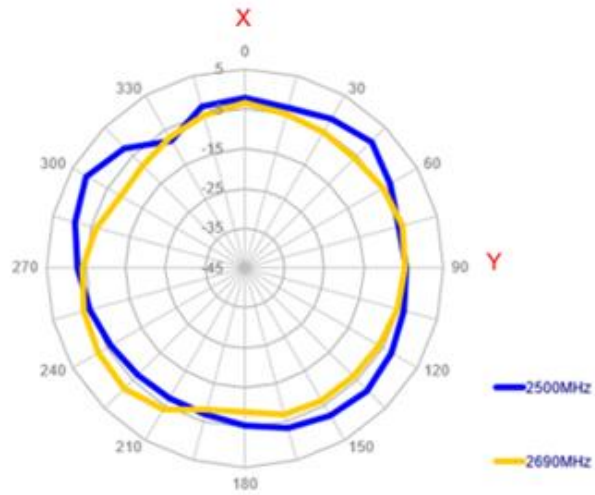
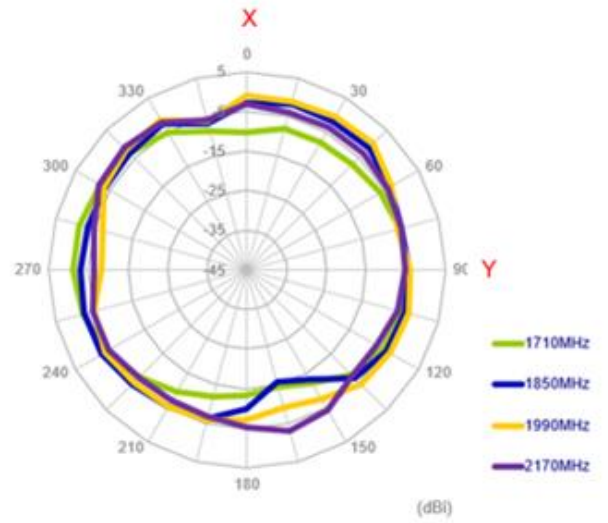
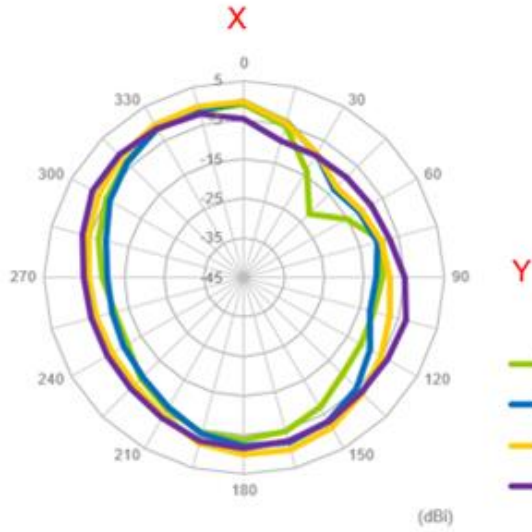

XZ Plane

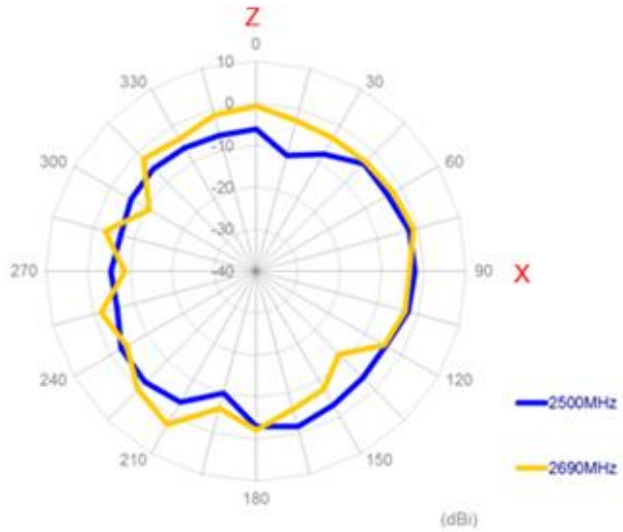
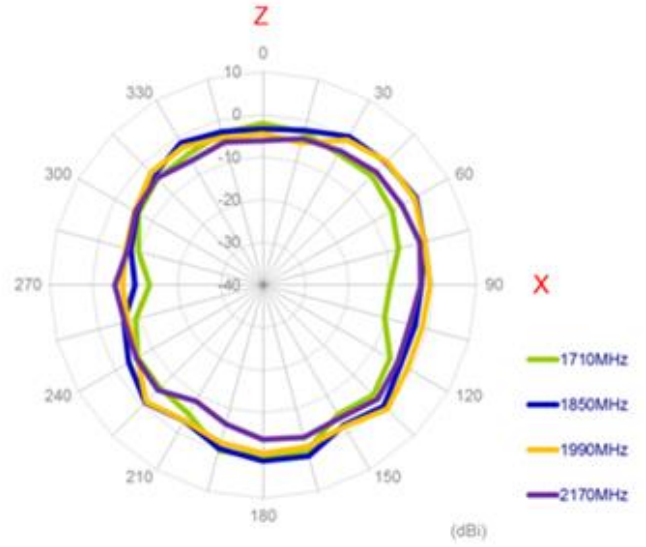
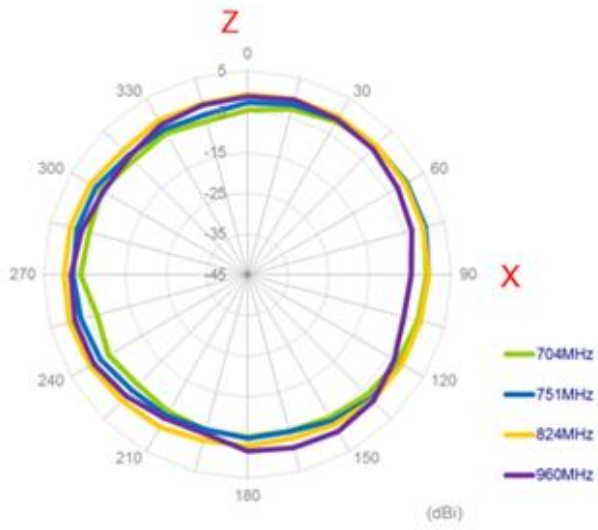

YZ Plane

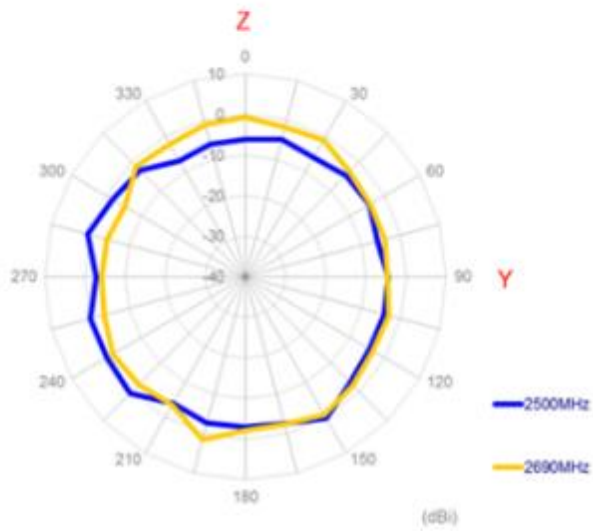
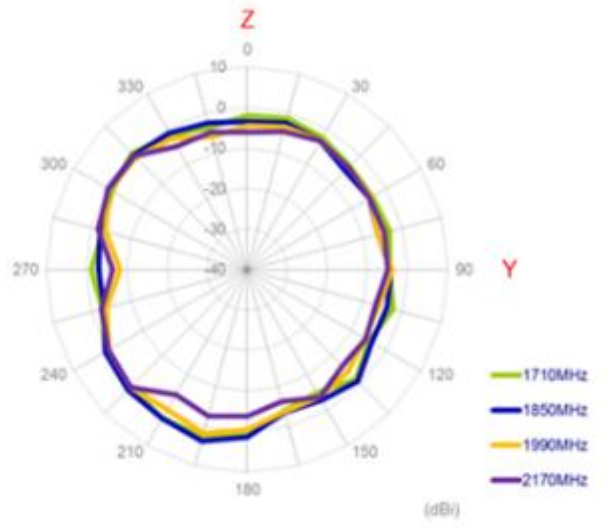
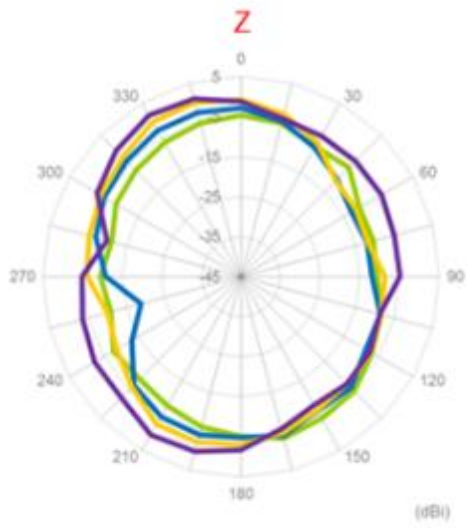

3.2.3. LTE with 2M cable length in free space (MIMO 2)

XY Plane

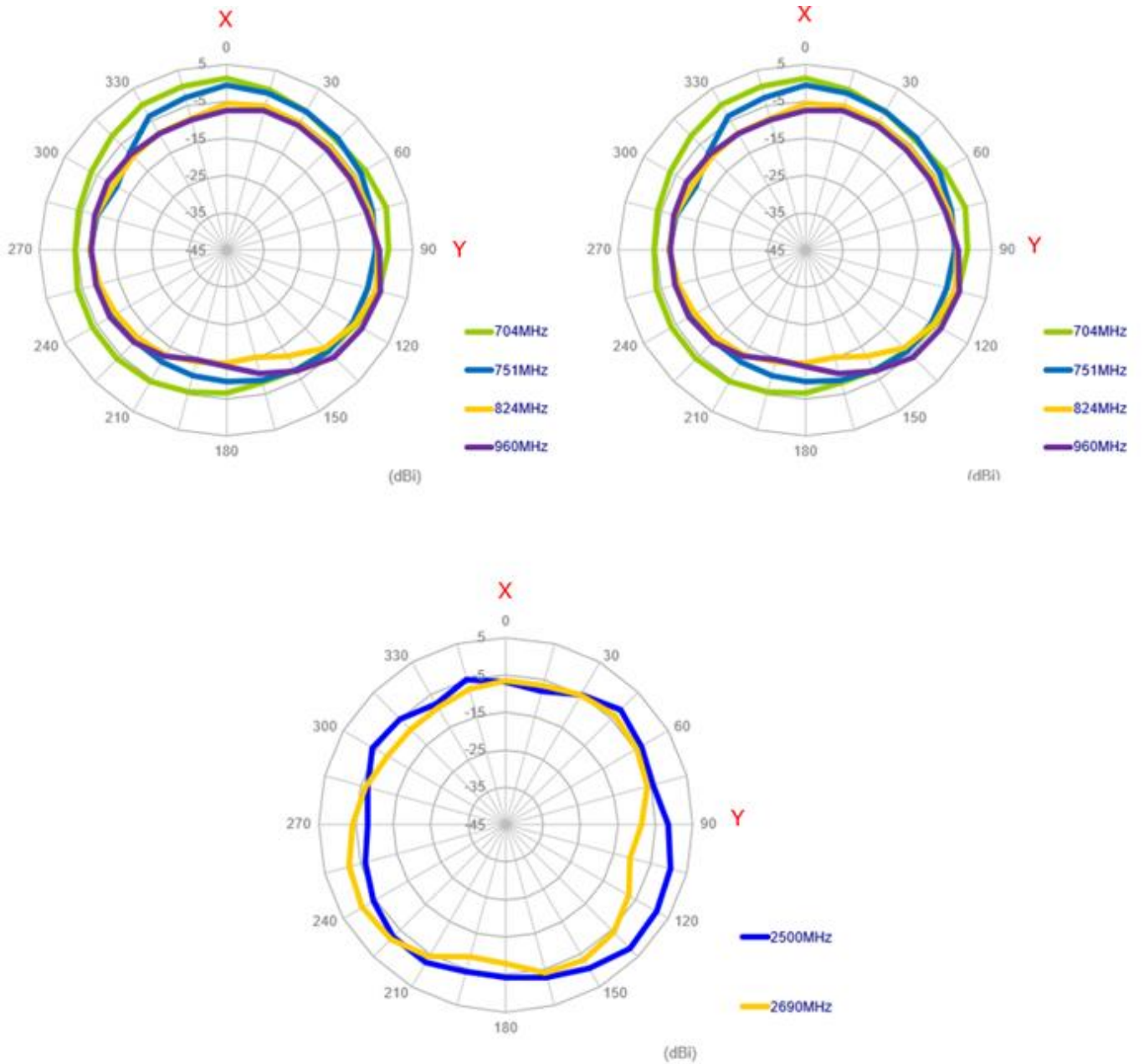

XZ Plane

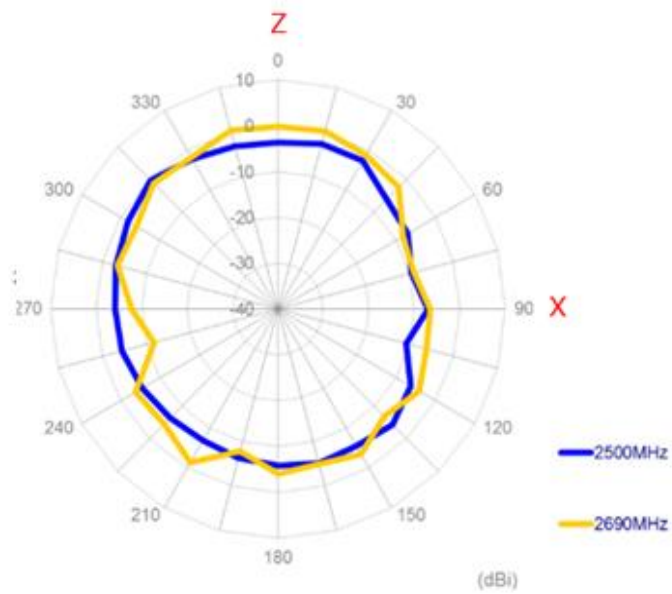
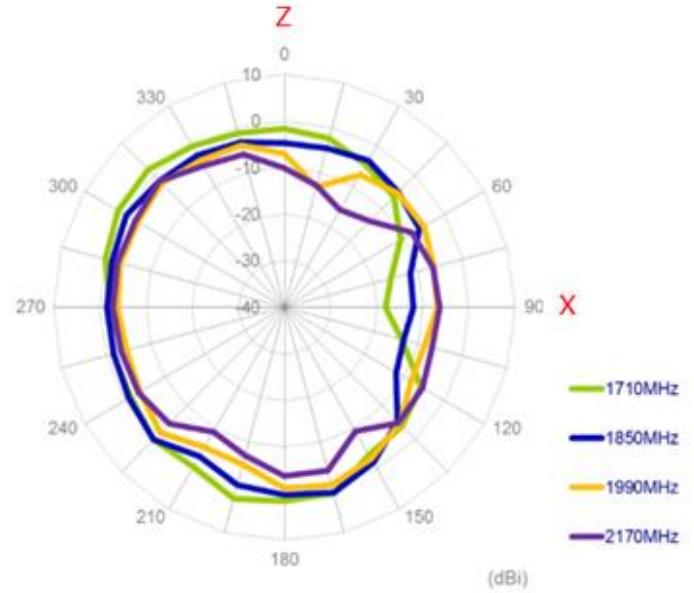
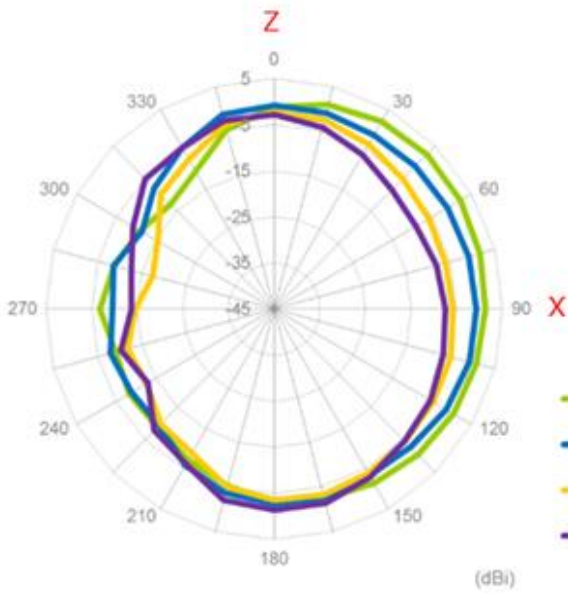

YZ Plane

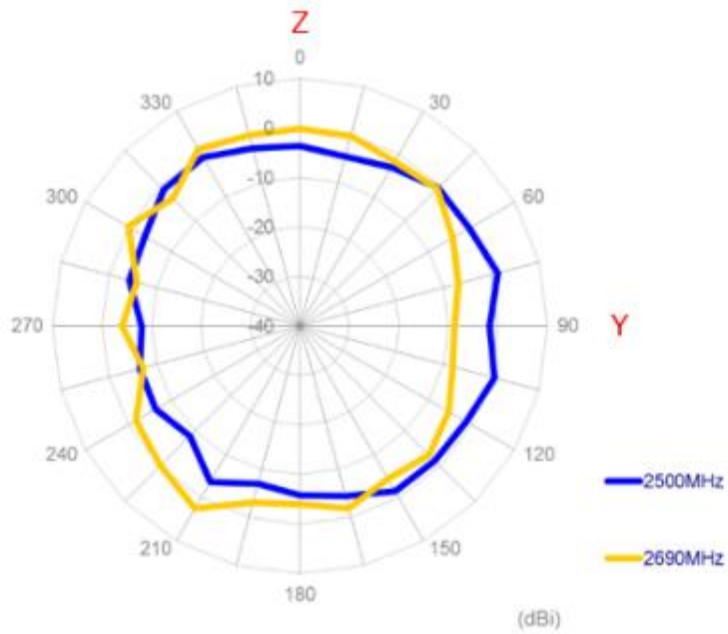
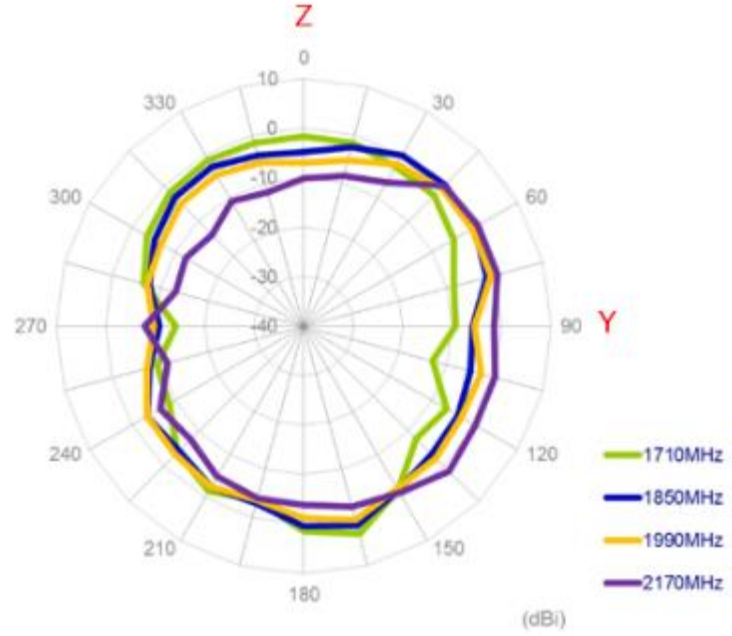
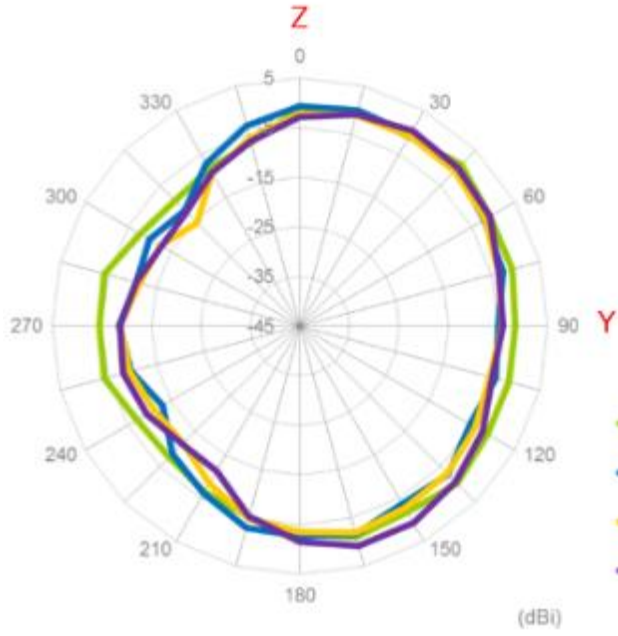

3.2.4. LTE with 2M cable length on the 2mm ABS (MIMO 1)

XY Plane

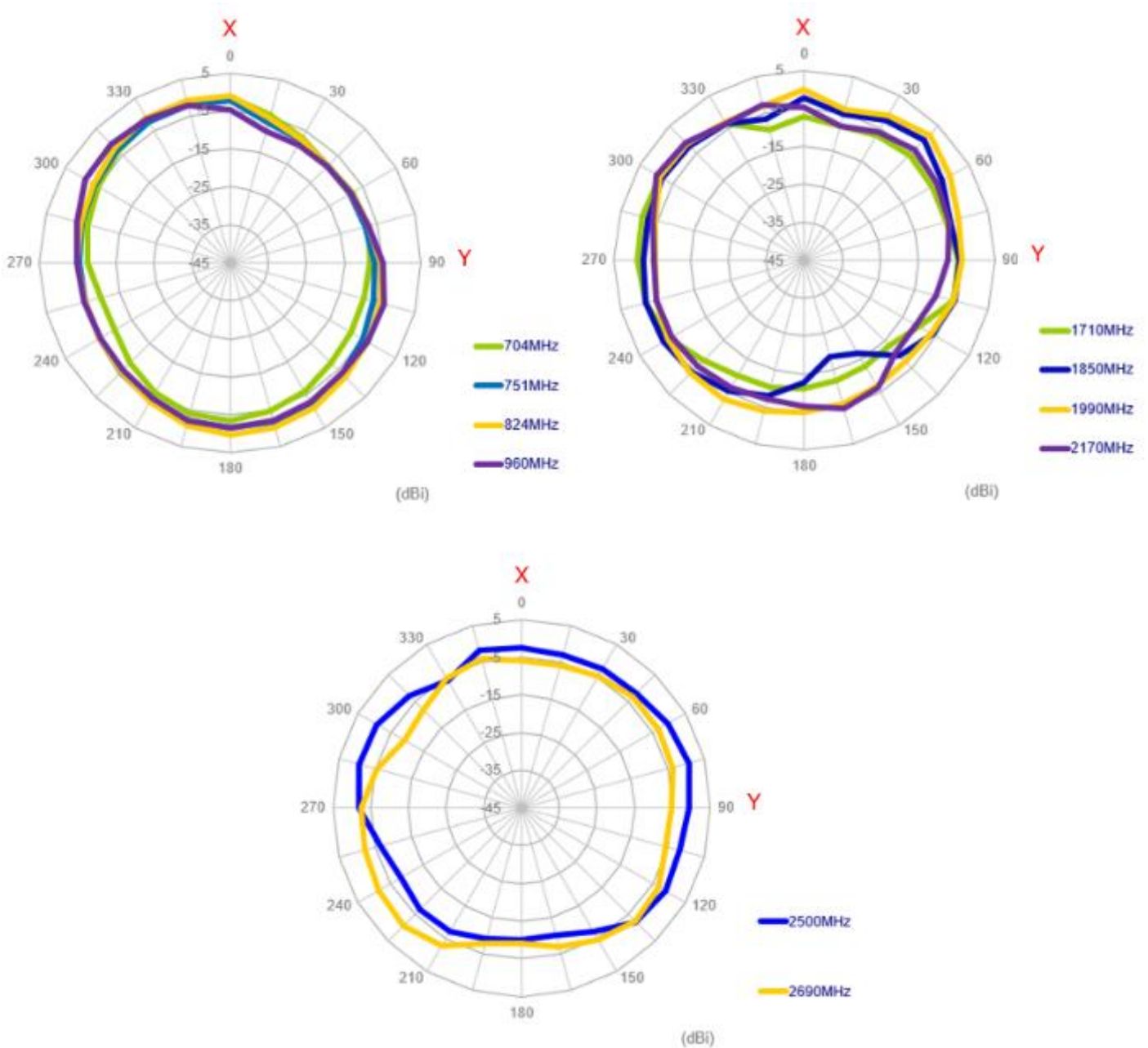

XZ Plane

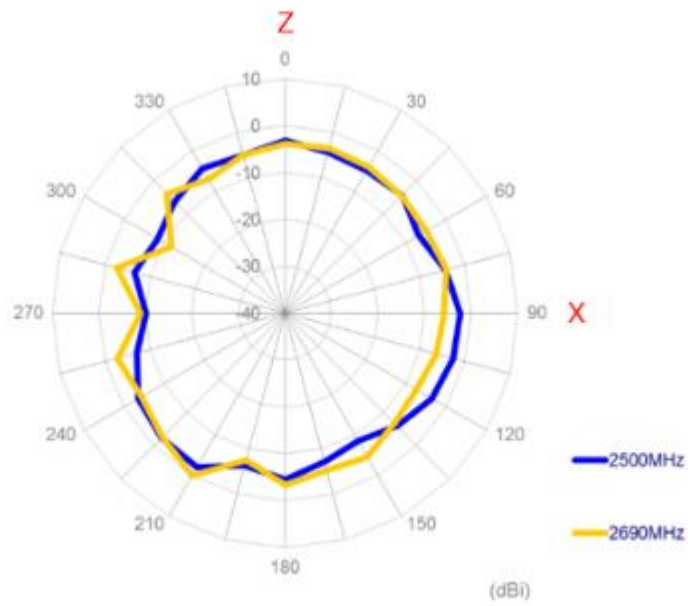
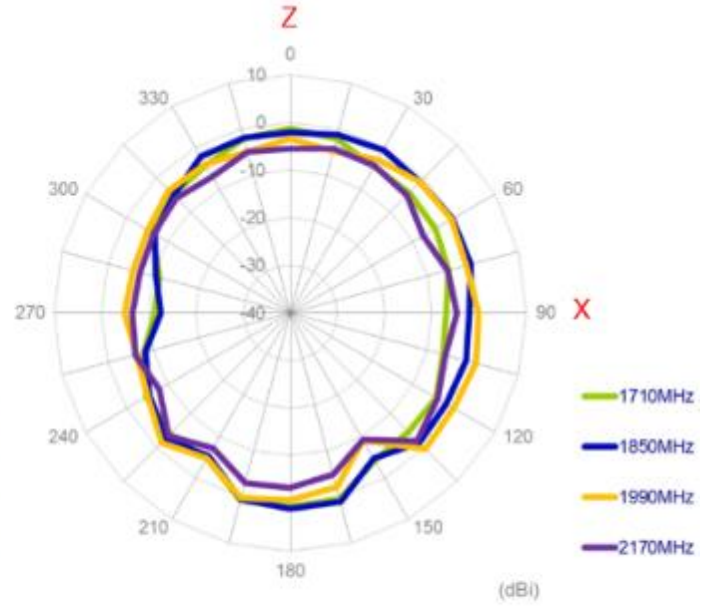
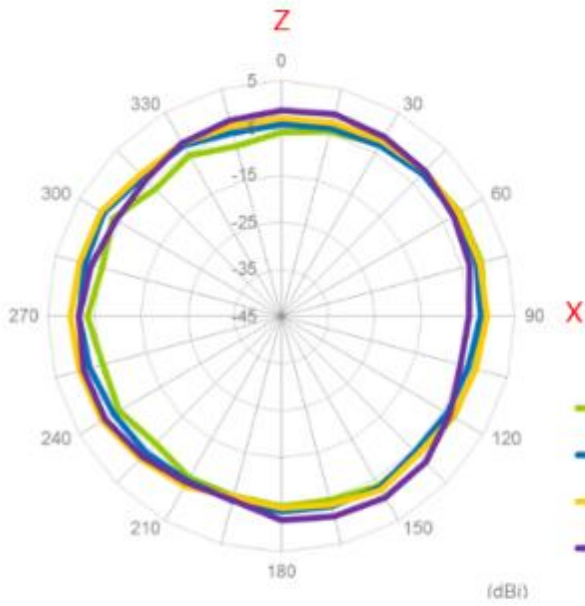

YZ Plane

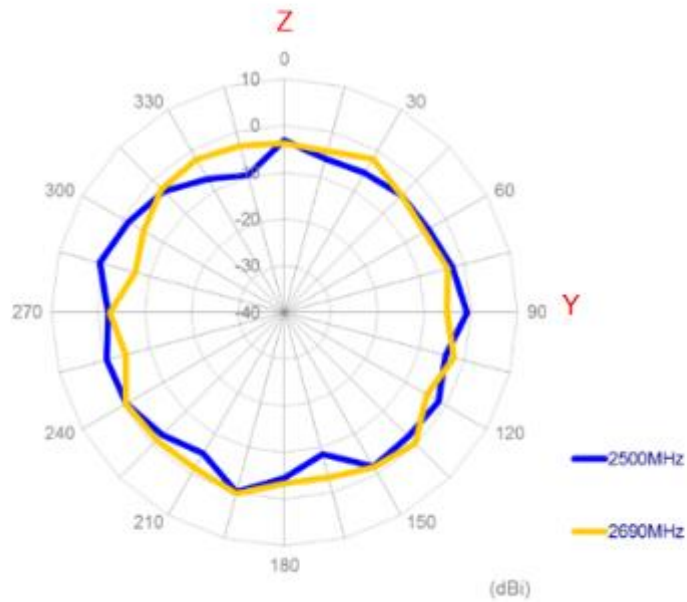
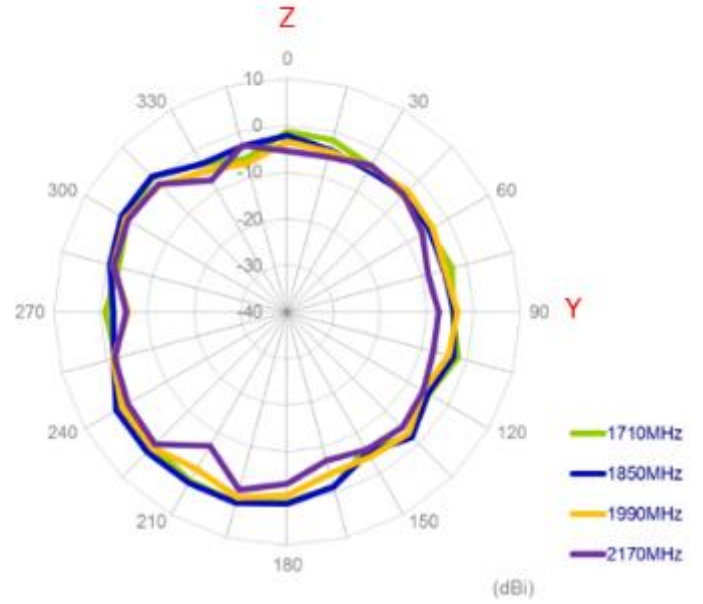
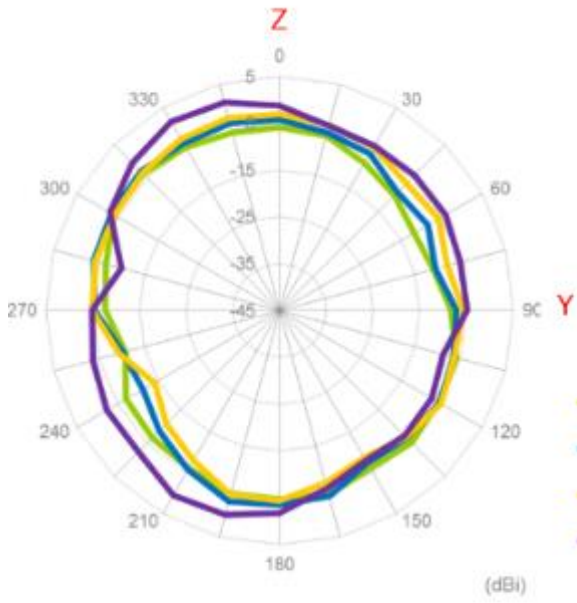

3.2.5. LTE with 2M cable length on the 2mm ABS (MIMO 2)

XY Plane

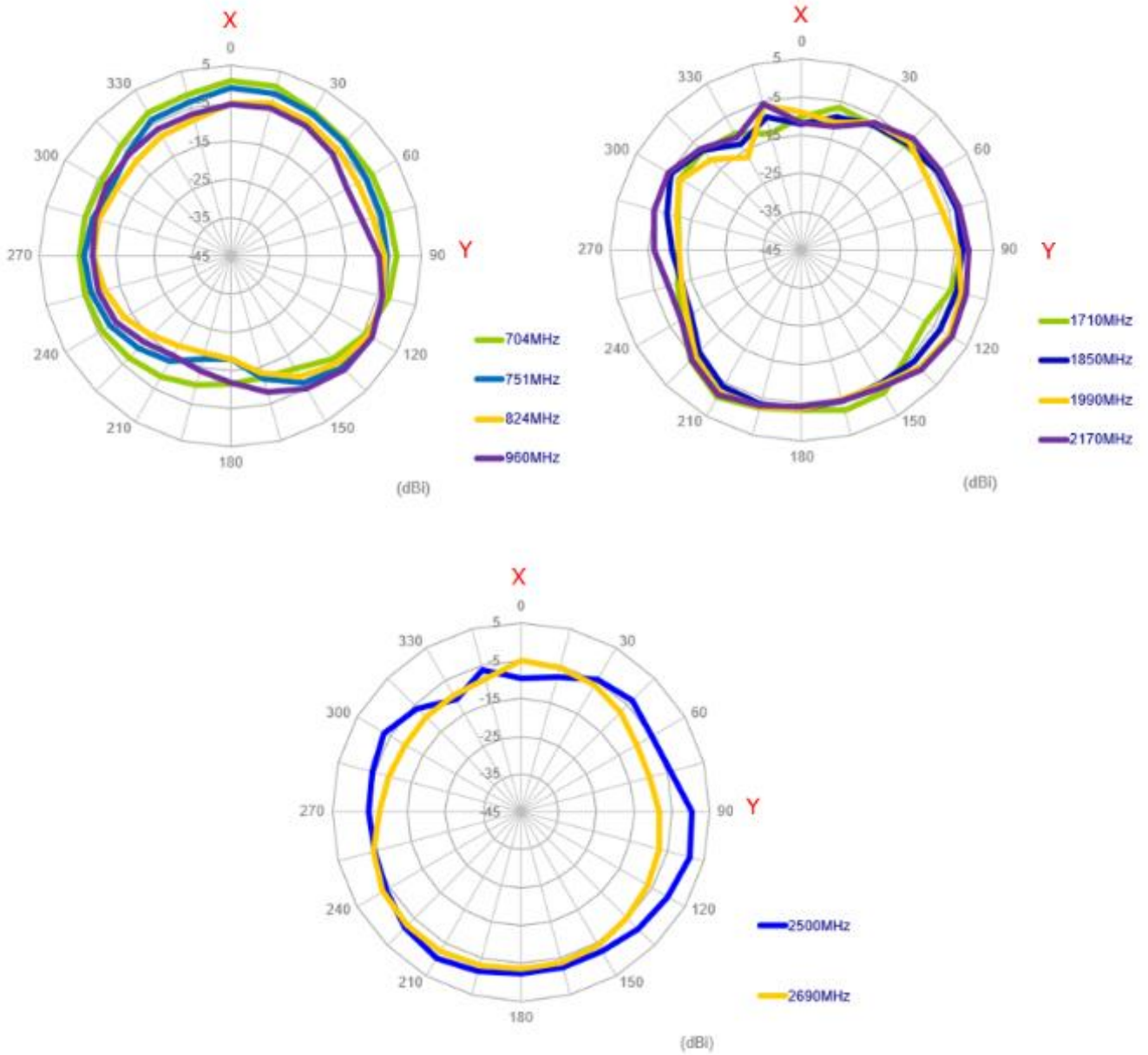

XZ Plane

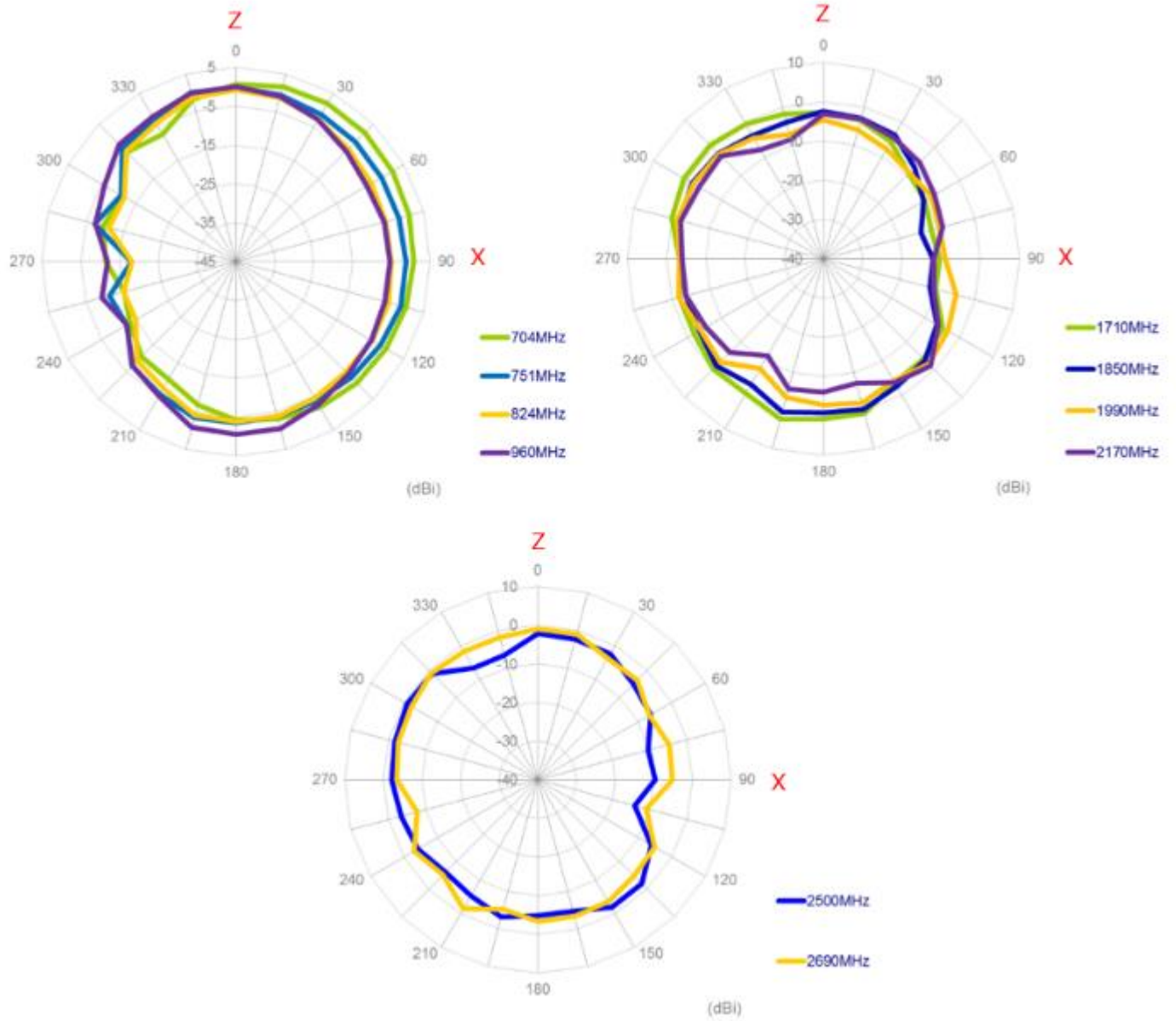

YZ Plane

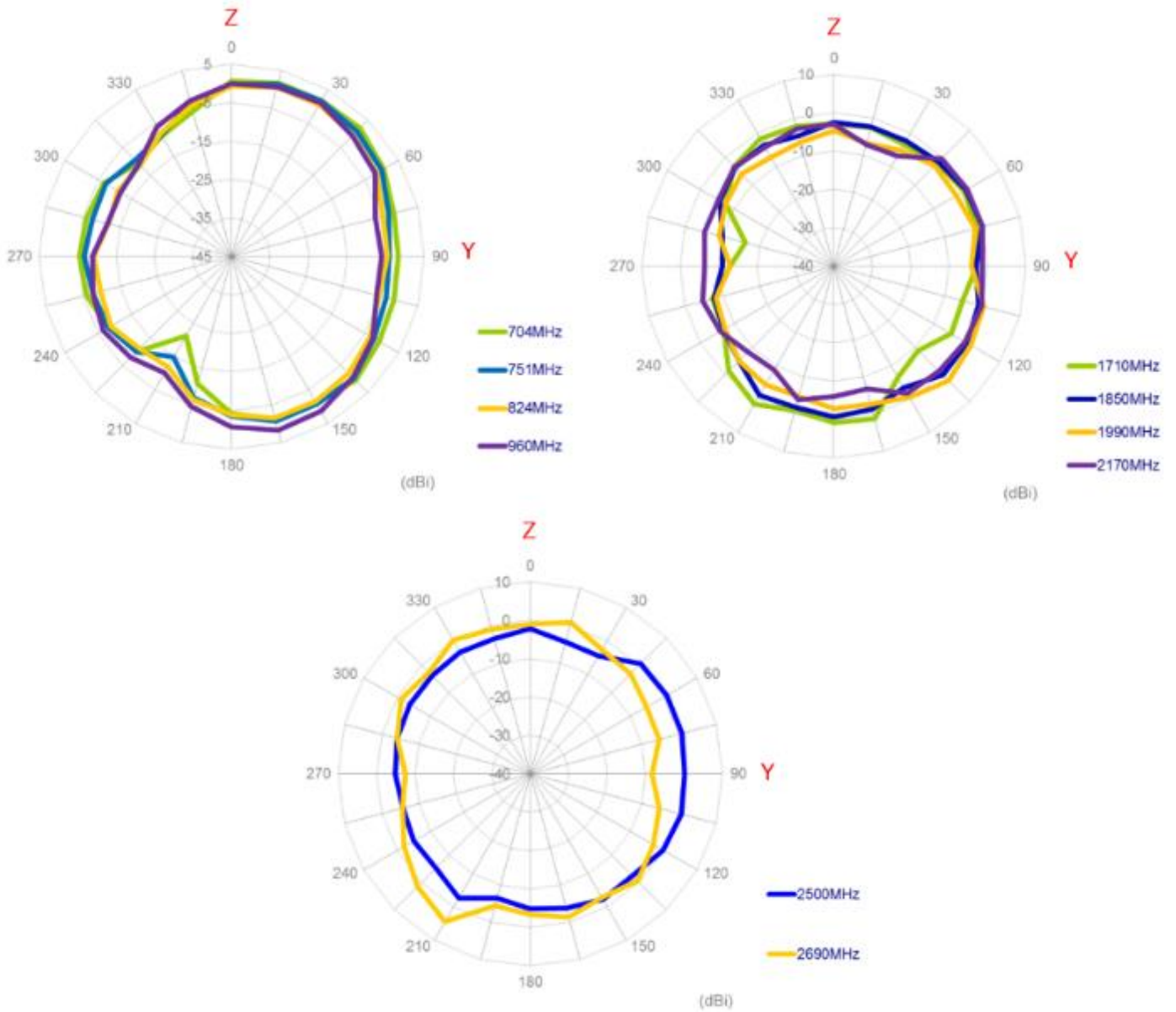

3.2.6. LTE with 2M cable length on the glass (MIMO 1)

XY Plane

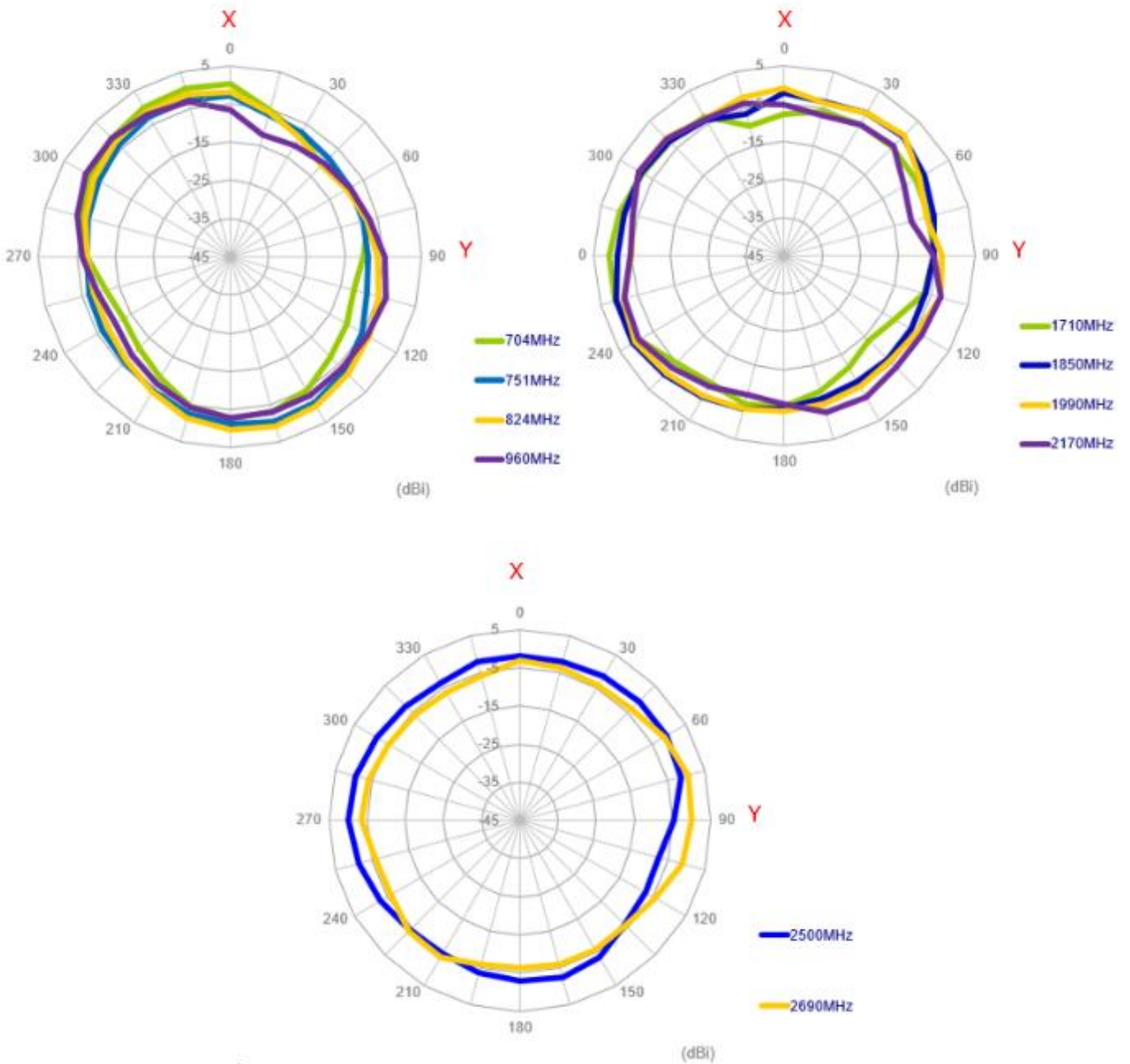

XZ Plane

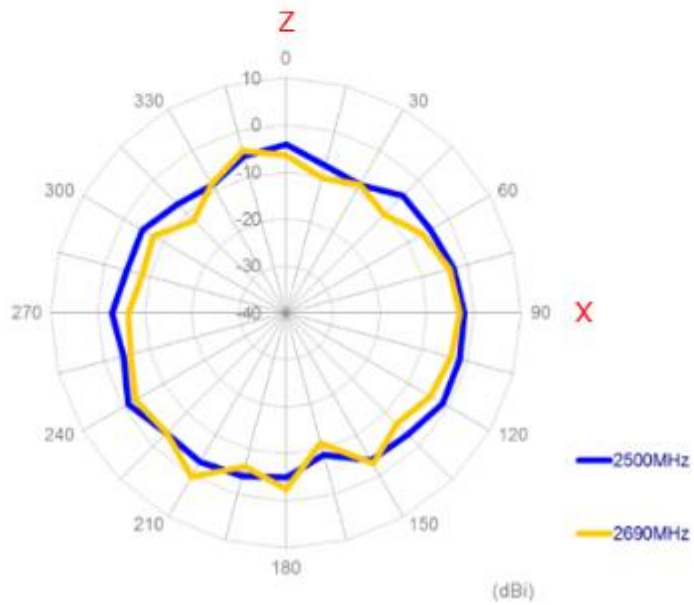
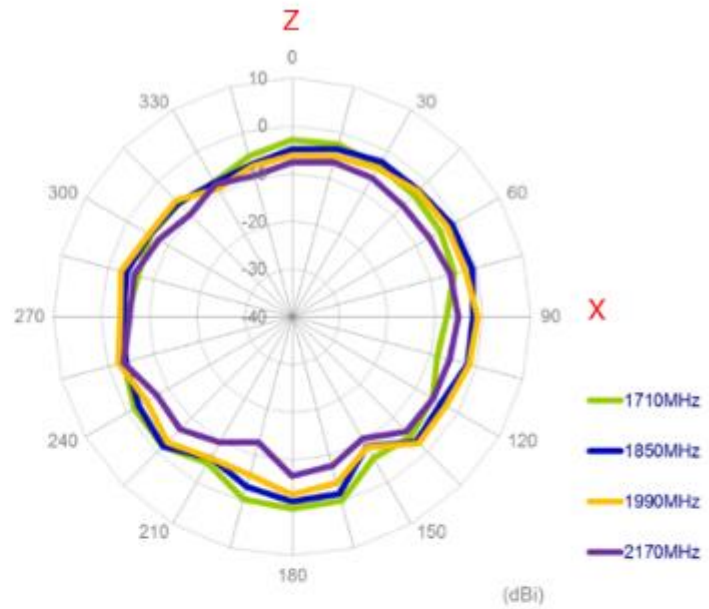
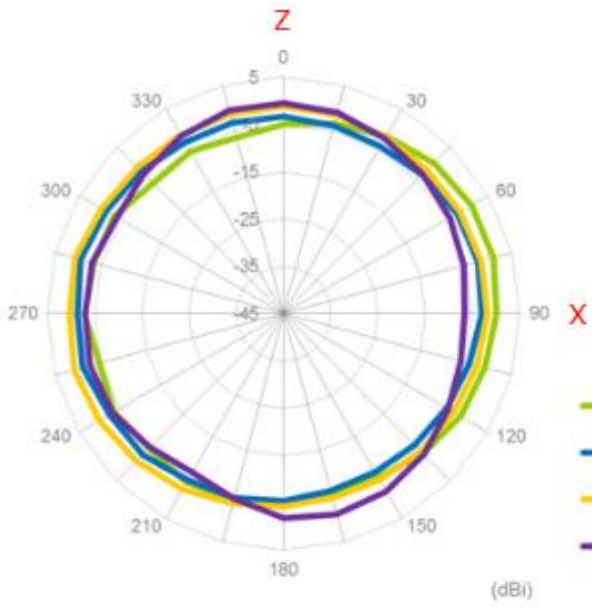

YZ Plane

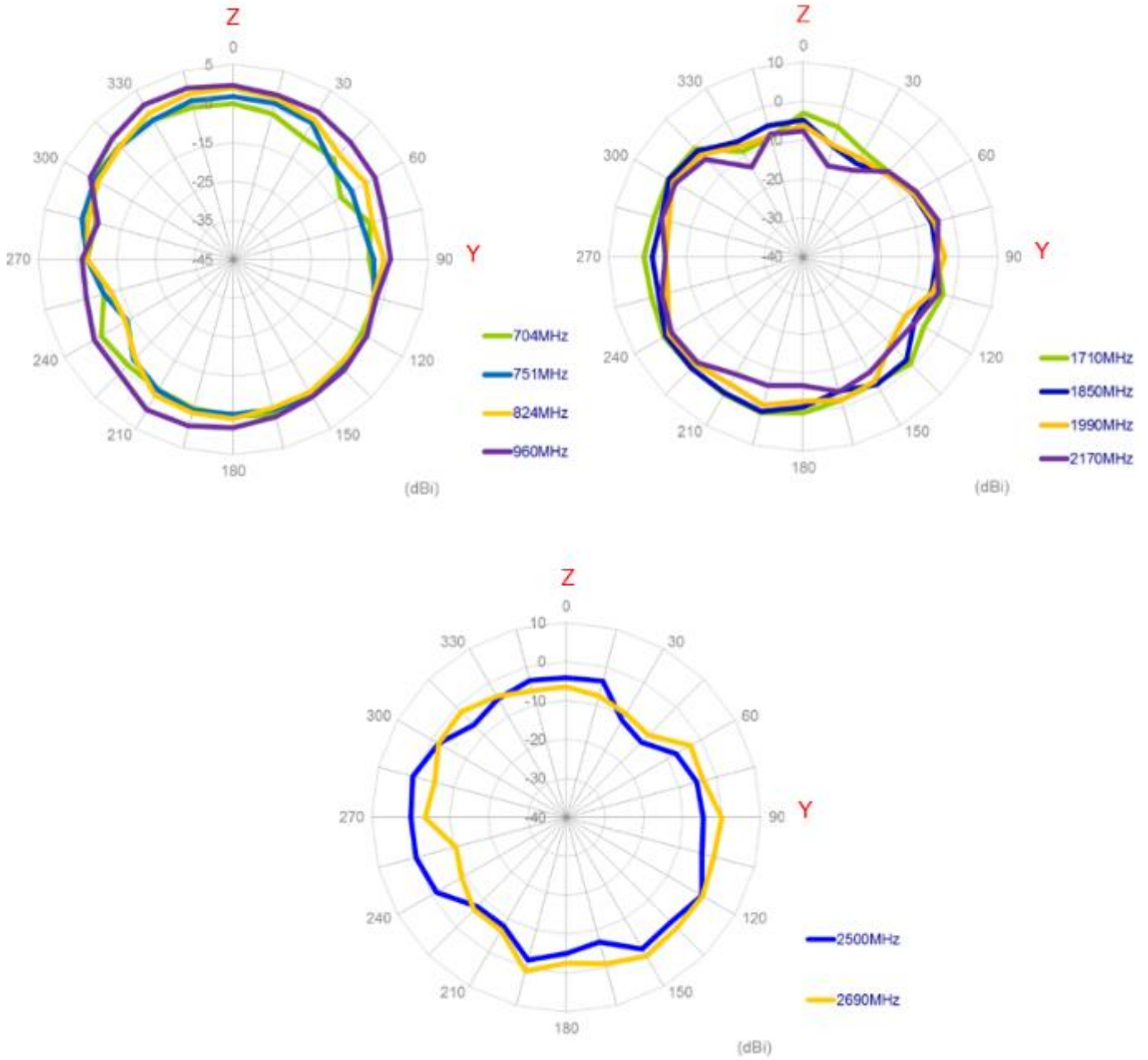

3.2.7. LTE with 2M cable length on the glass (MIMO 2)

XY Plane

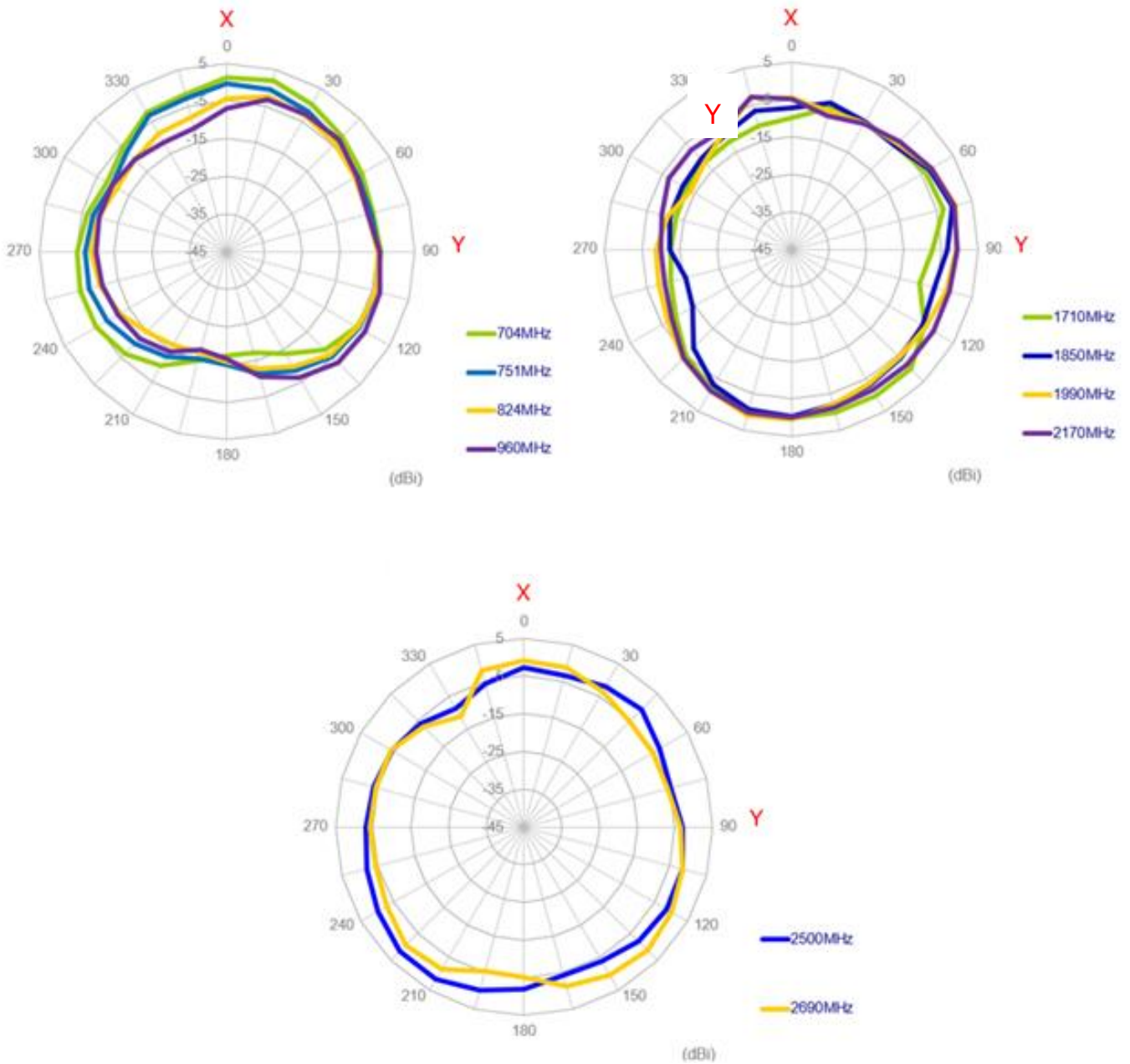

XZ Plane

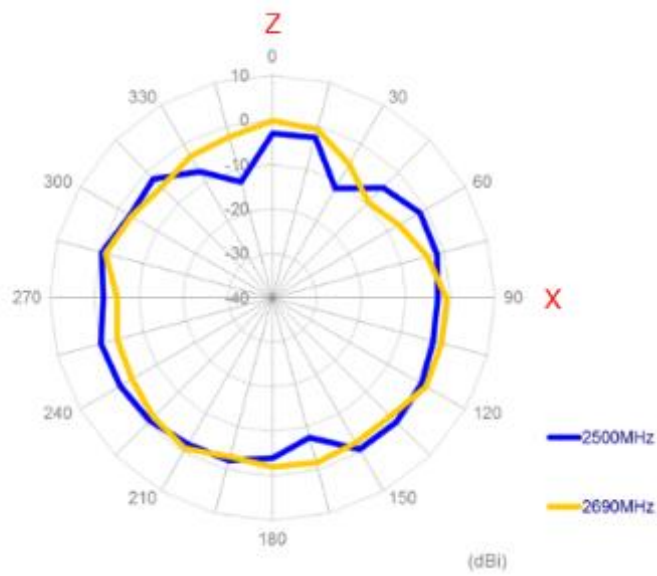
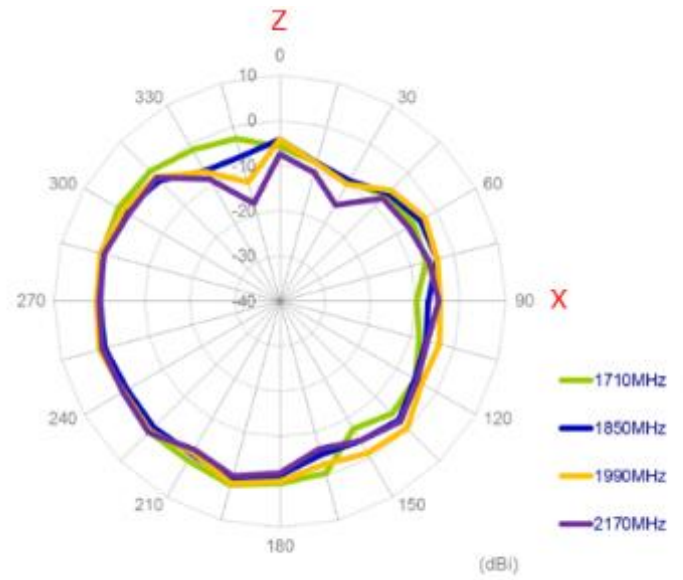
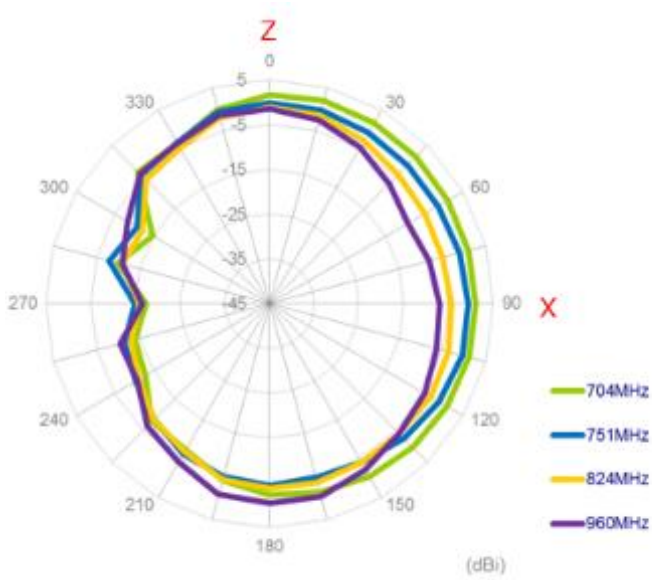

YZ Plane

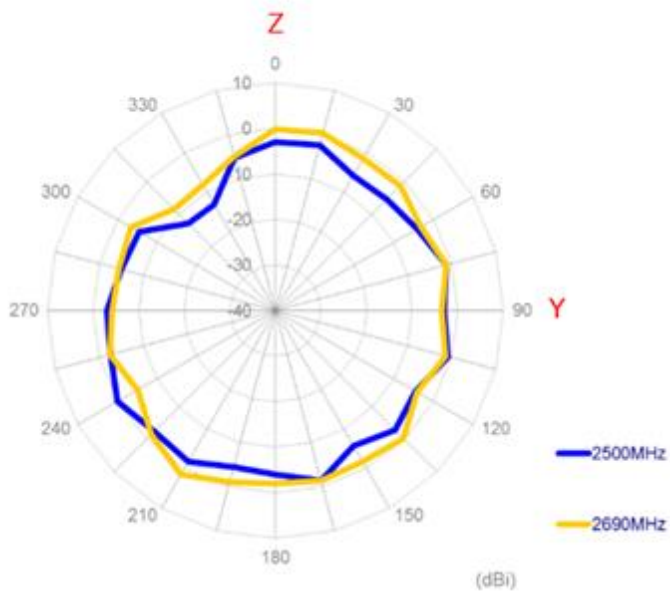
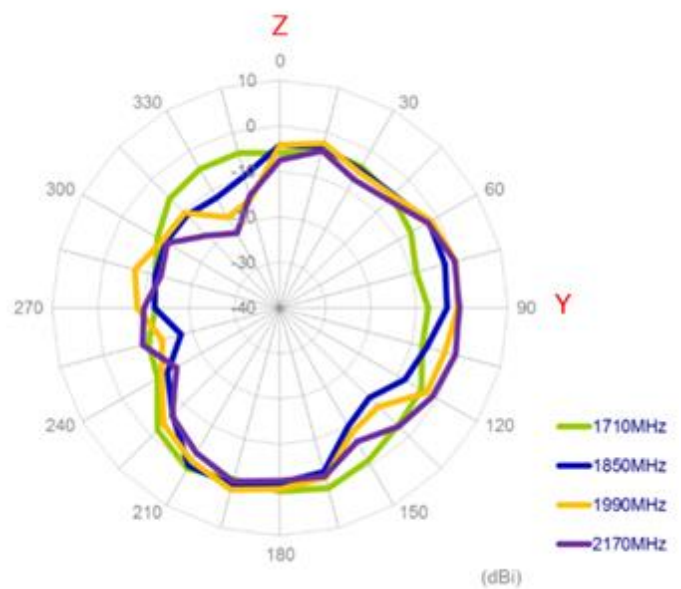
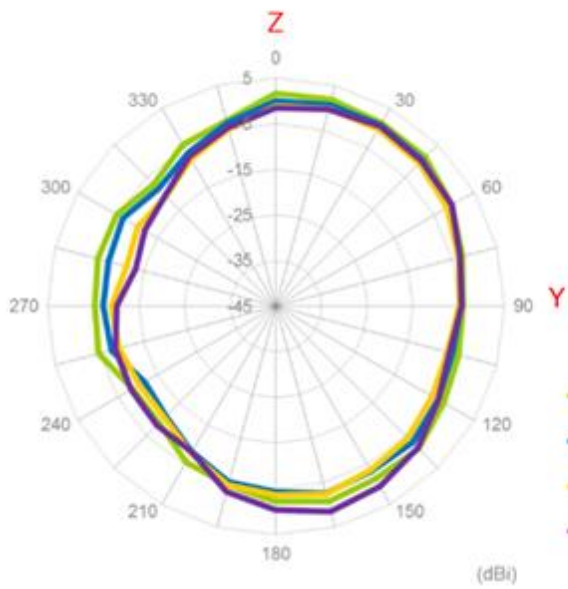

3.3. 3D Radiation Pattern

3.3.1. LTE with 2M cable length in free space (MIMO 1)

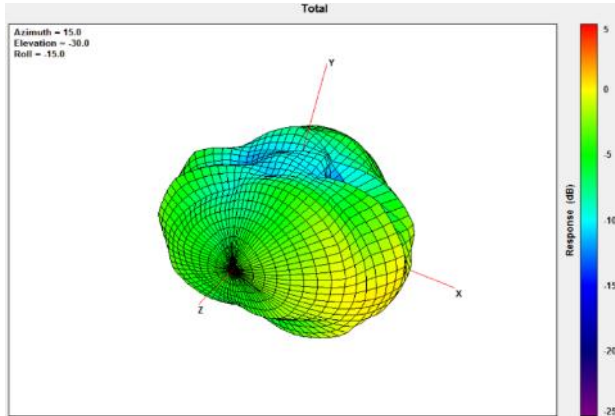

704MHz

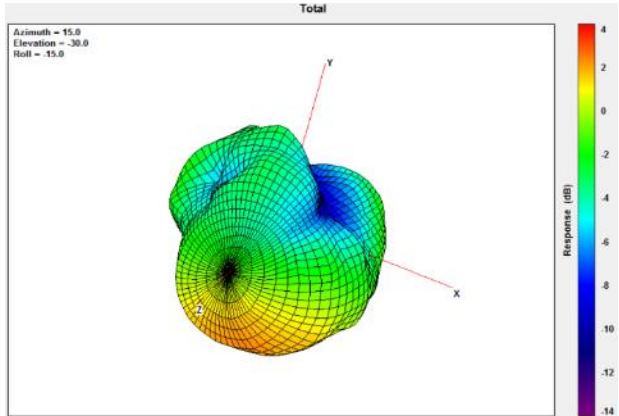

960MHz

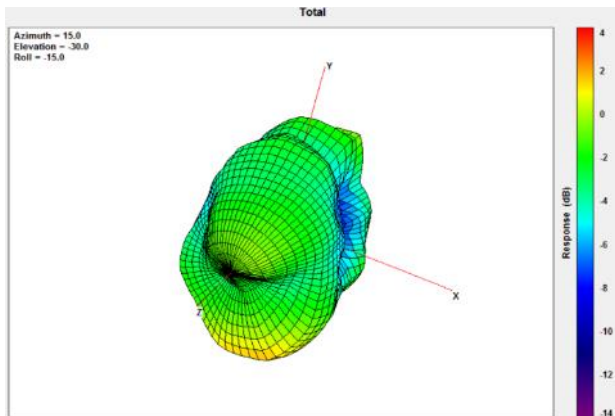

1710MHz

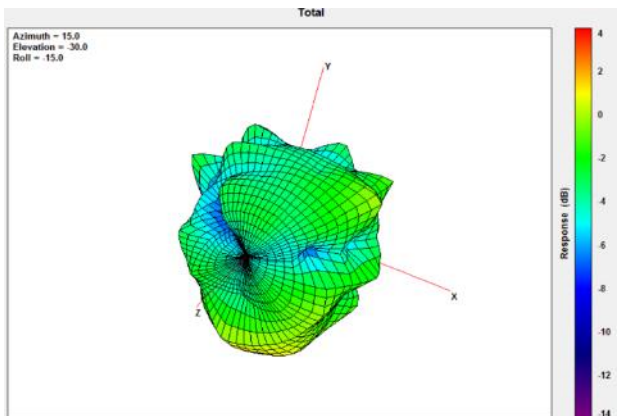

2170MHz

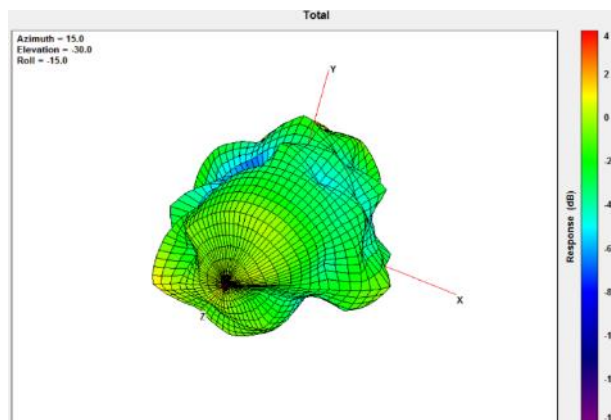

2690MHz

3.3.2. LTE with 2M cable length in free space (MIMO 2)

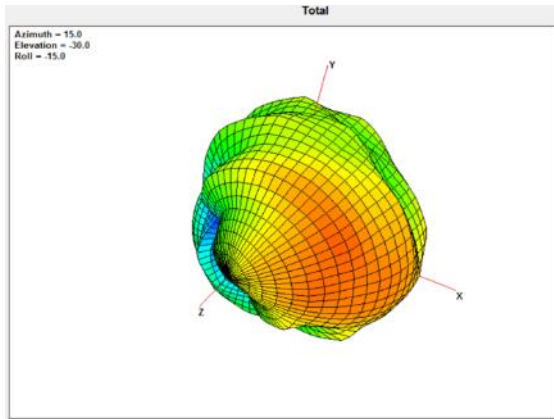

704MHz

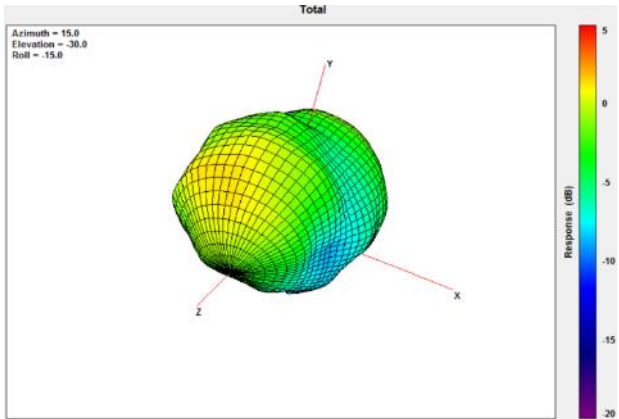

960MHz

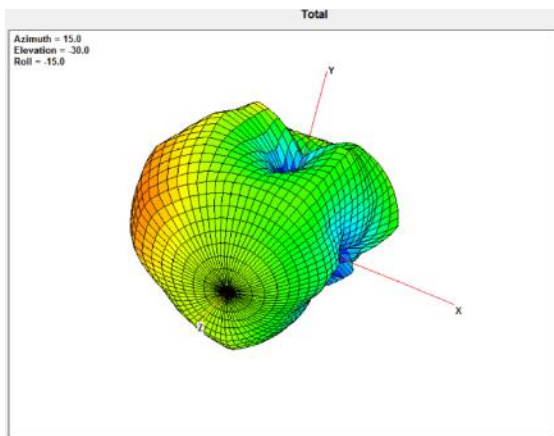

1710MHz

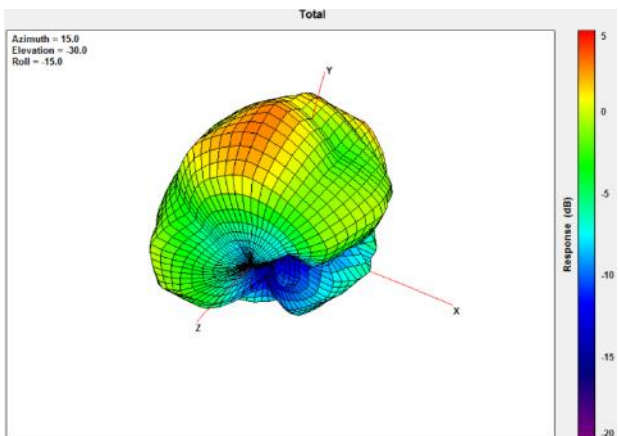

2170MHz

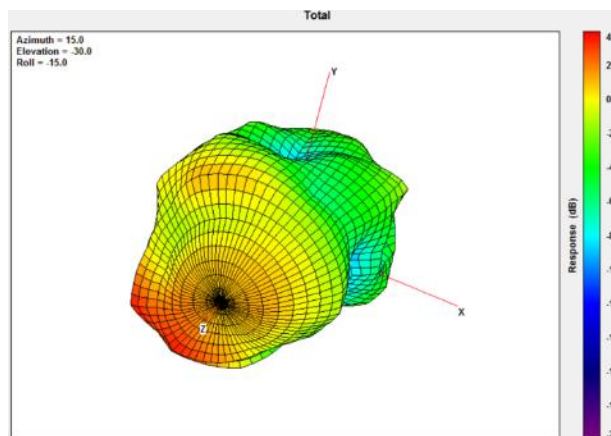

2690MHz

3.3.3. LTE with 2M cable length on the 2mm ABS (MIMO 1)

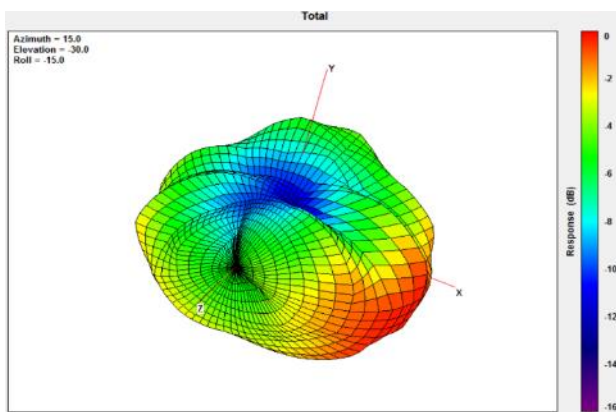

704MHz

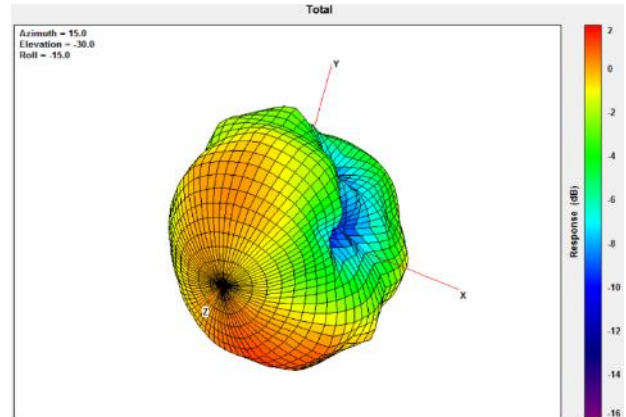

960MHz

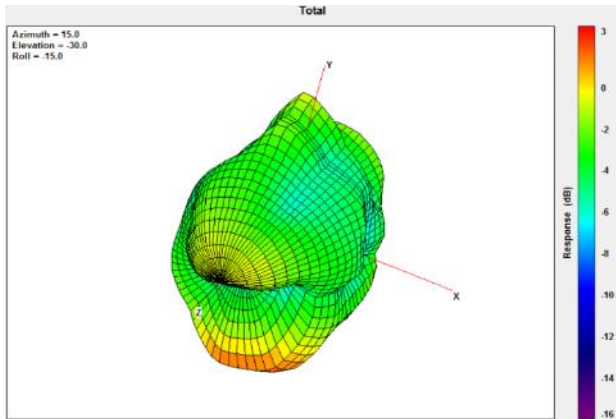

1710MHz

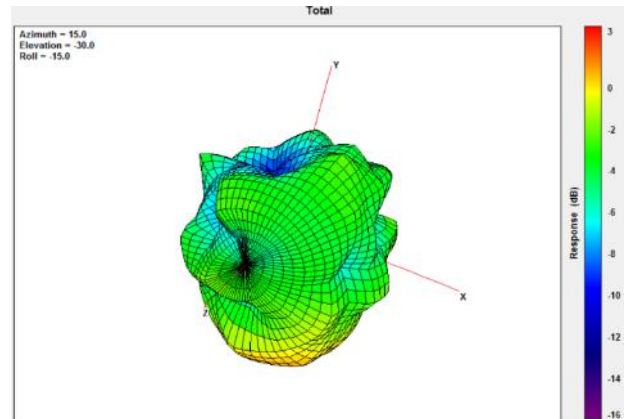

2170MHz

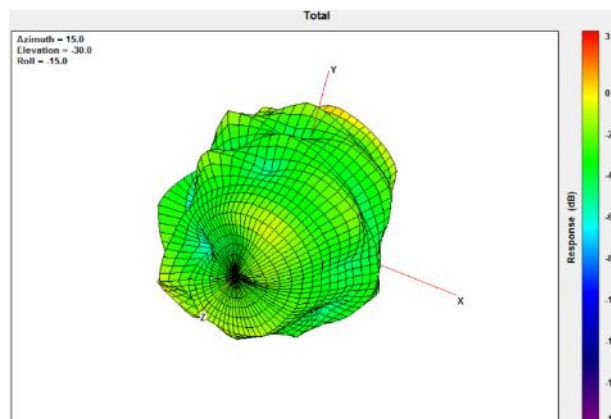

2690MHz

3.3.4. LTE with 2M cable length on the 2mm ABS (MIMO 2)

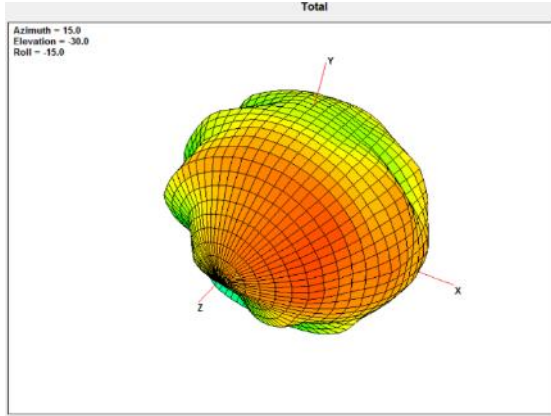

704MHz

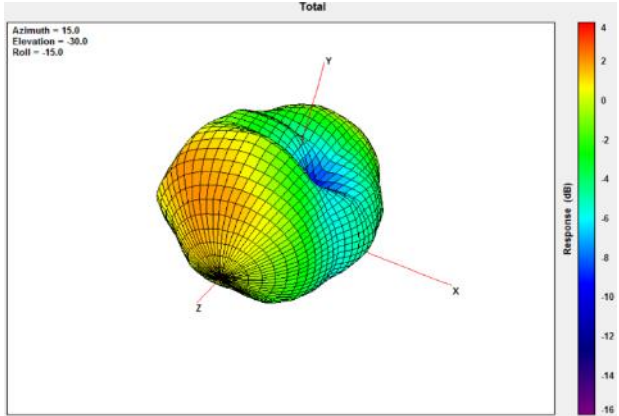

960MHz

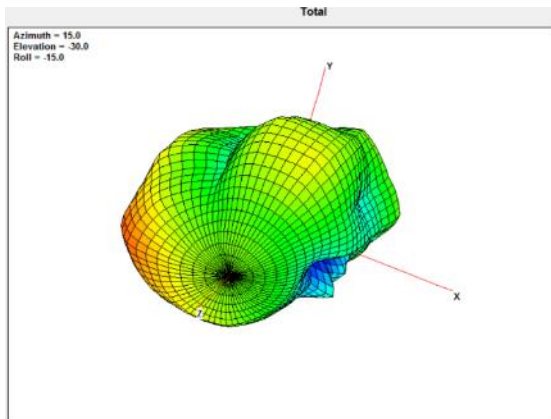

1710MHz

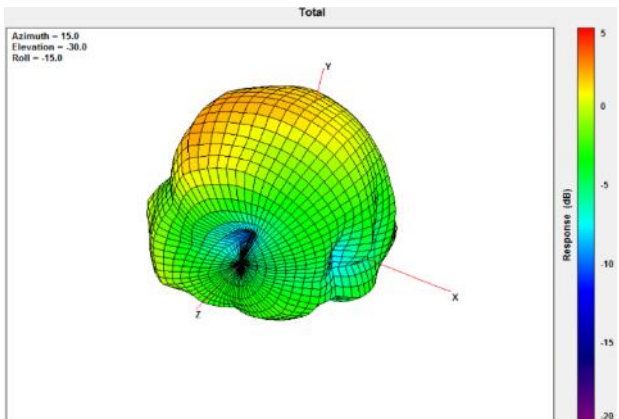

2170MHz

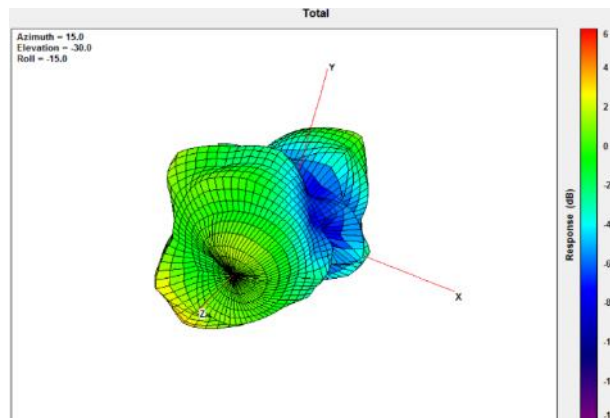

2690MHz

3.3.5. LTE with 2M cable length on the glass (MIMO 1)

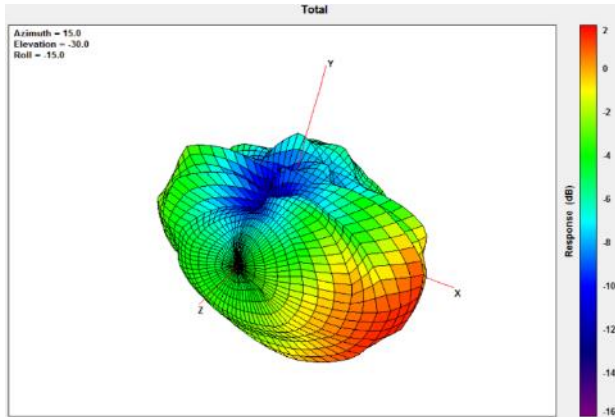

704MHz

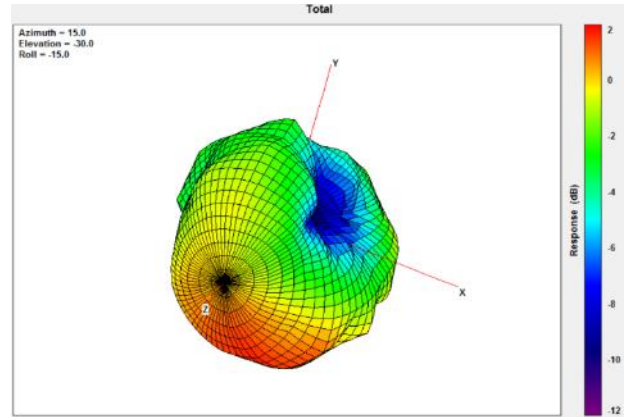

960MHz

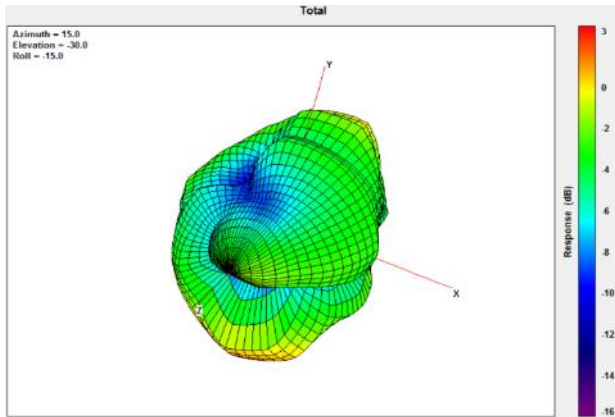

1710MHz

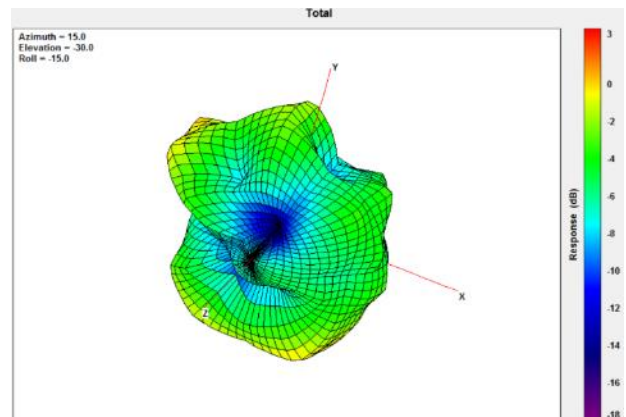

2170MHz

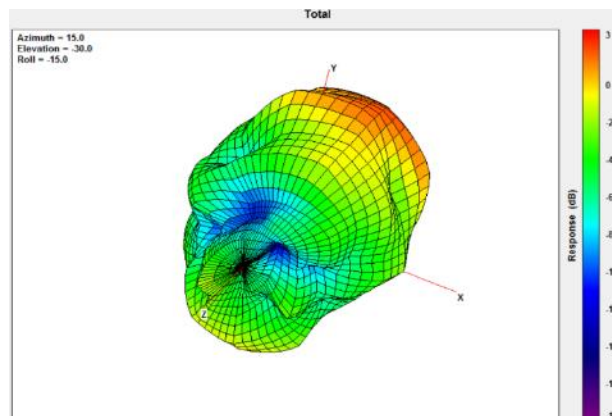

2690MHz

3.3.6. LTE with 2M cable length on the glass (MIMO 2)

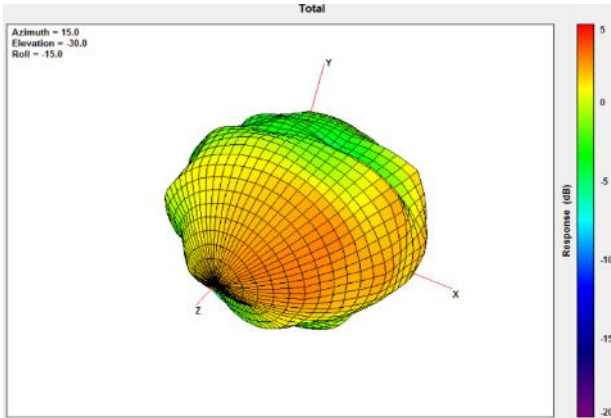

704MHz

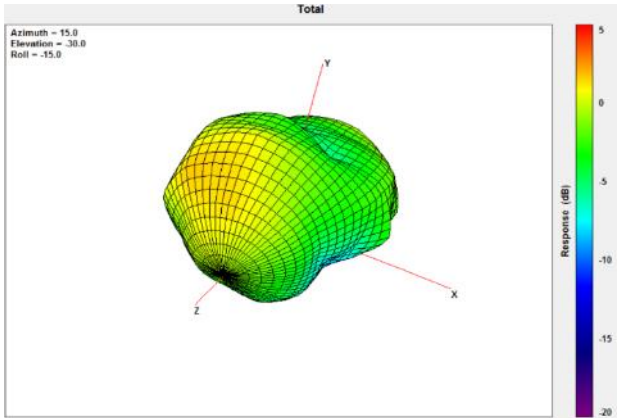

960MHz

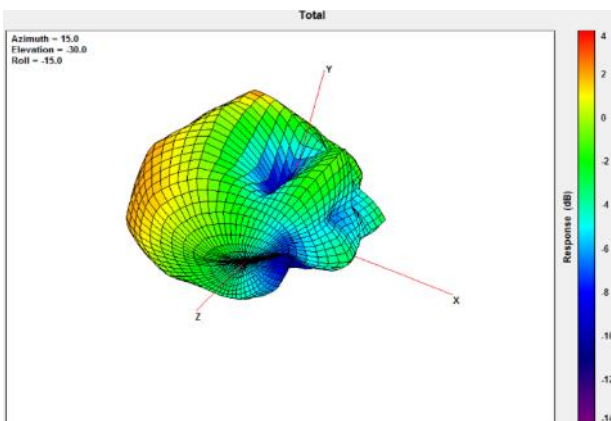

1710MHz

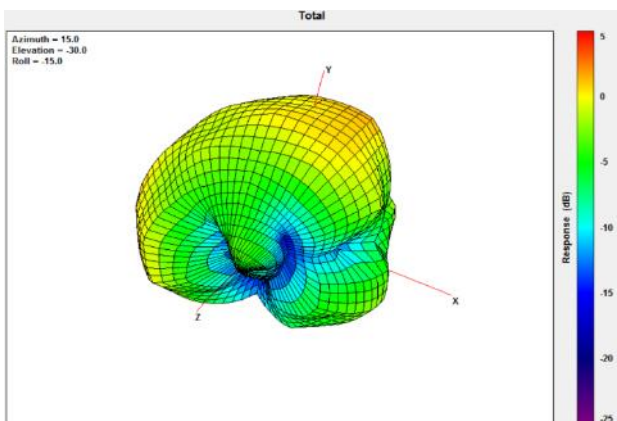

2170MHz

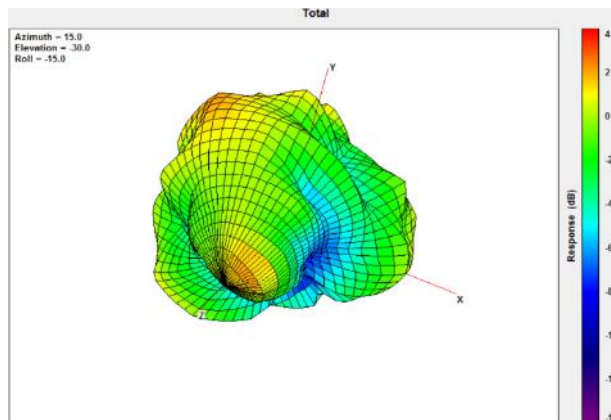

2690MHz

4. Drawing

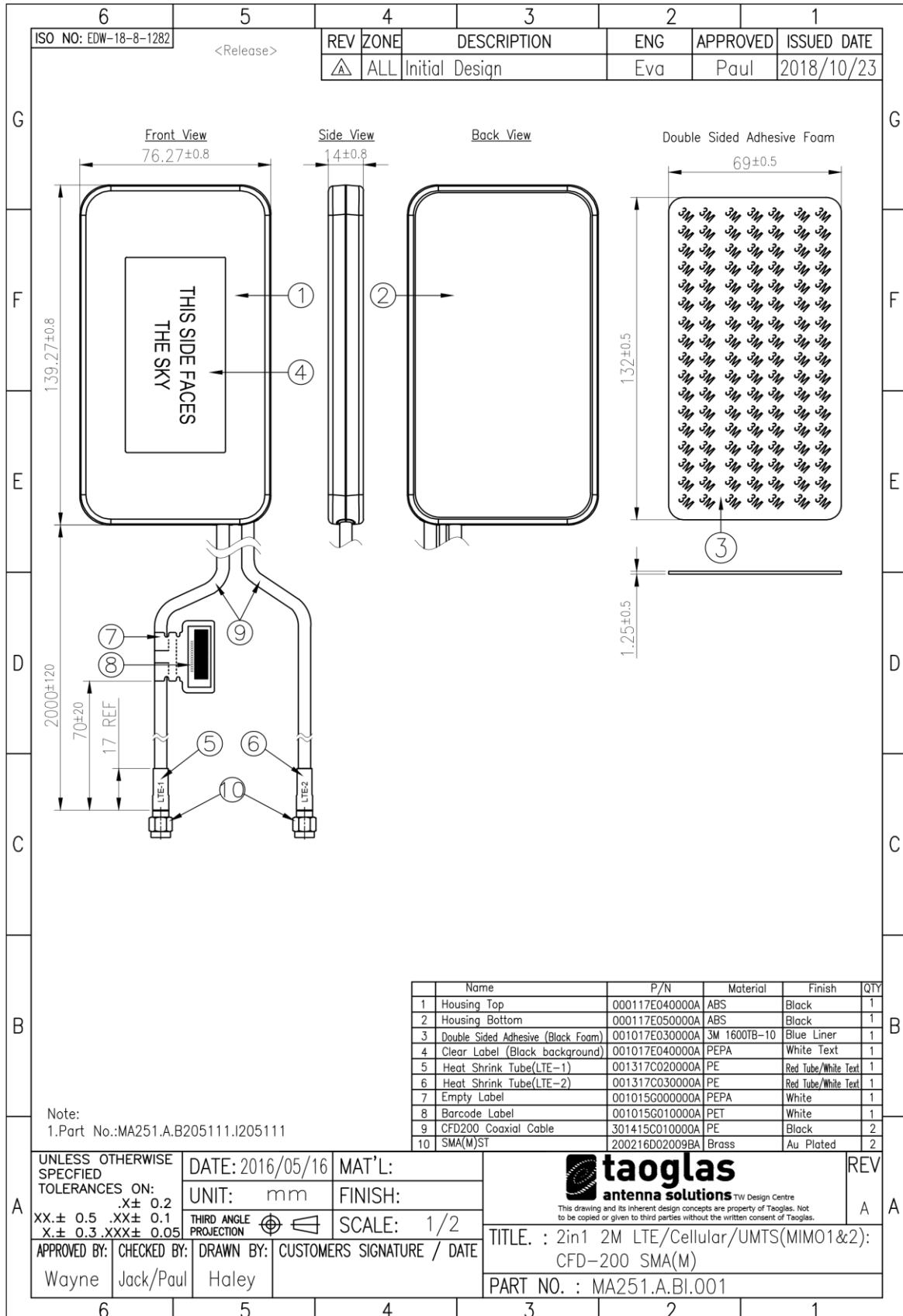

5. Packaging

MA251.A.BI.001

Packaging Specifications

1pcs MA251.A.BI.001 per PE Bag
 Bag Dimensions - 300 x 200mm
 Weight - 227g

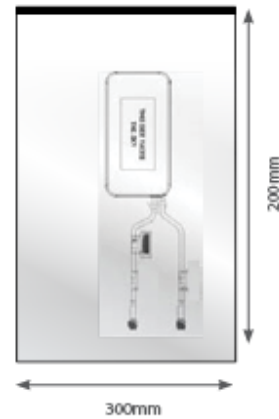

40 pcs MA251.A.BI.001 per carton
 Carton - 740x 370 x 300mm
 Weight - 11.1Kg

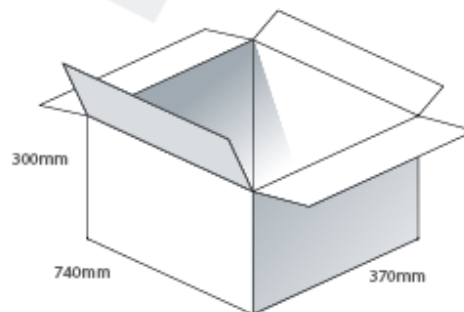

Pallet Dimensions 120 x 100x 140cm
 12 Cartons per Pallet
 6 Cartons per layer
 2 Layers

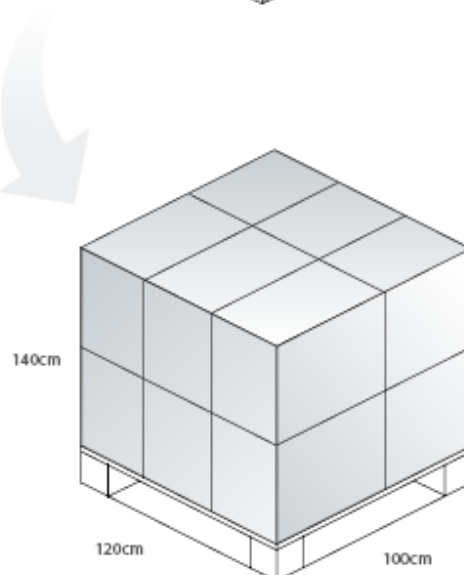

6. Application Note

The antenna is tested with different cable lengths and various base mounting options to indicate its performance to act as a reference for a customer's design.

In Free Space

LTE MIMO 1

Return Loss

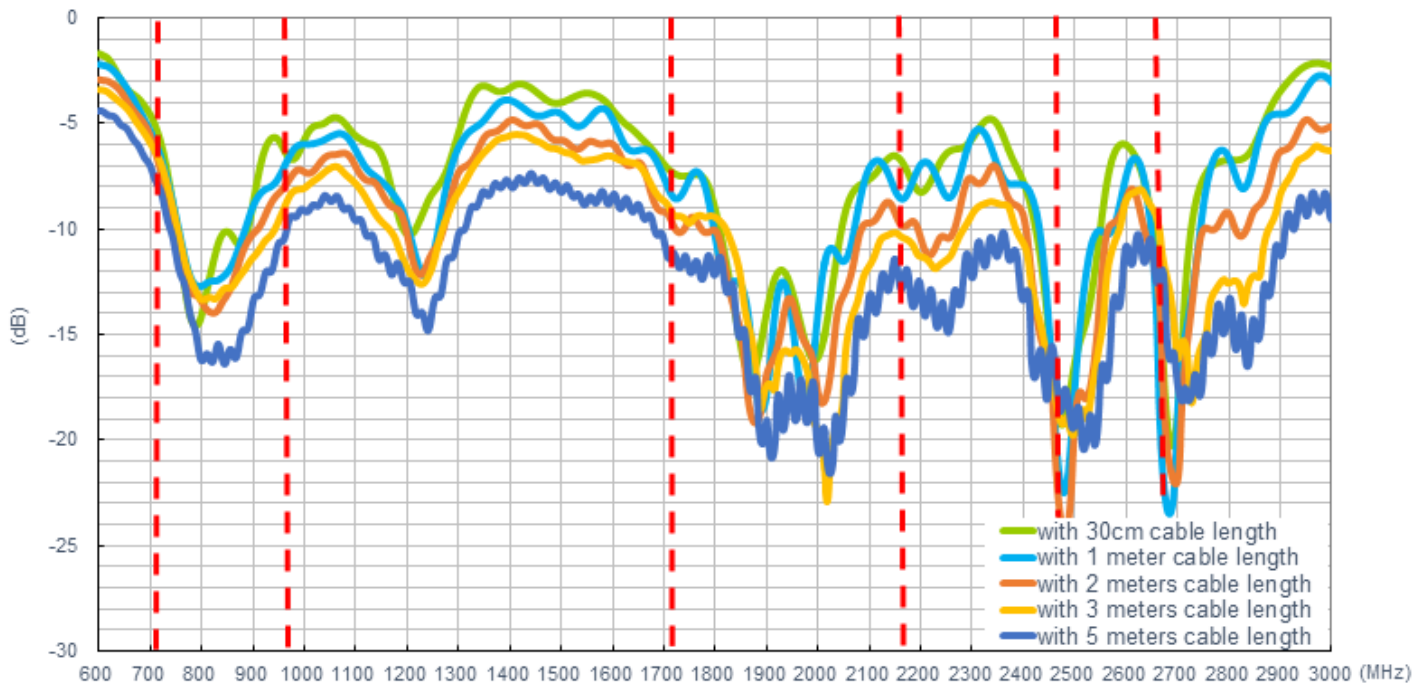

Efficiency

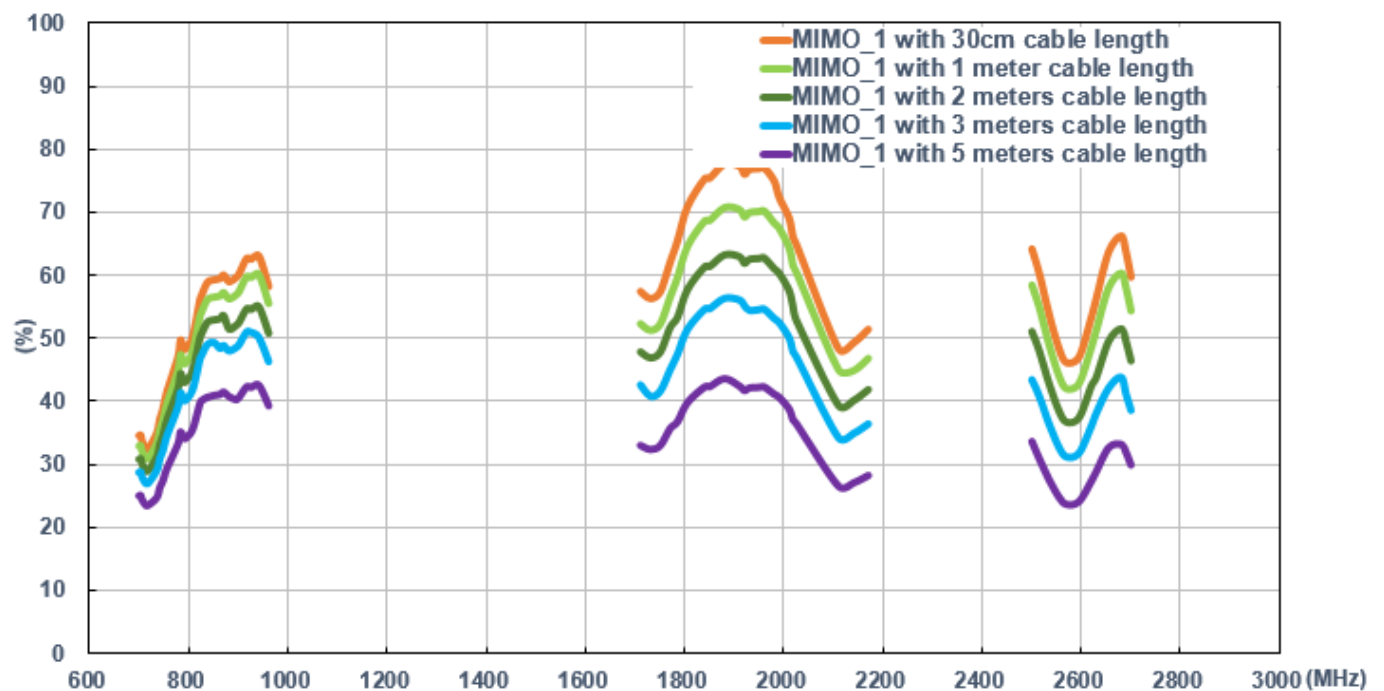

Average Gain

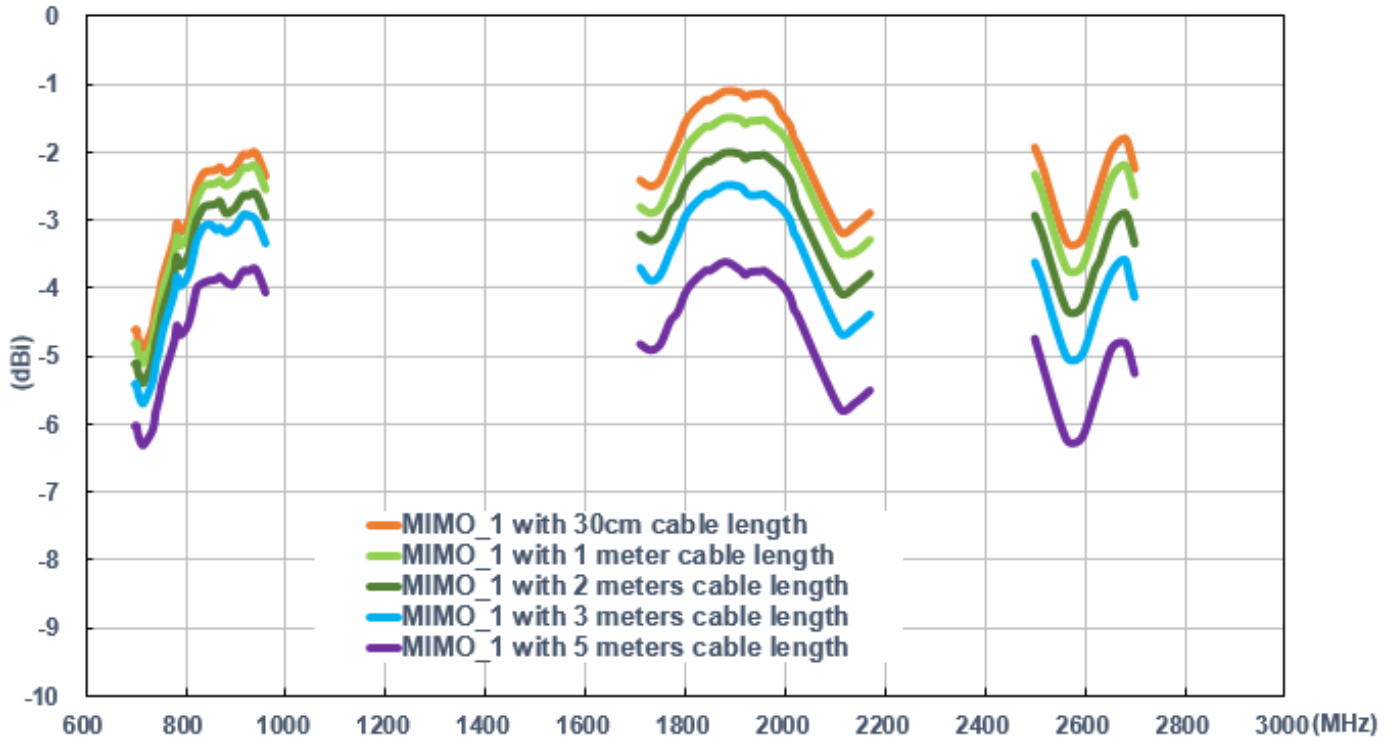

Peak Gain

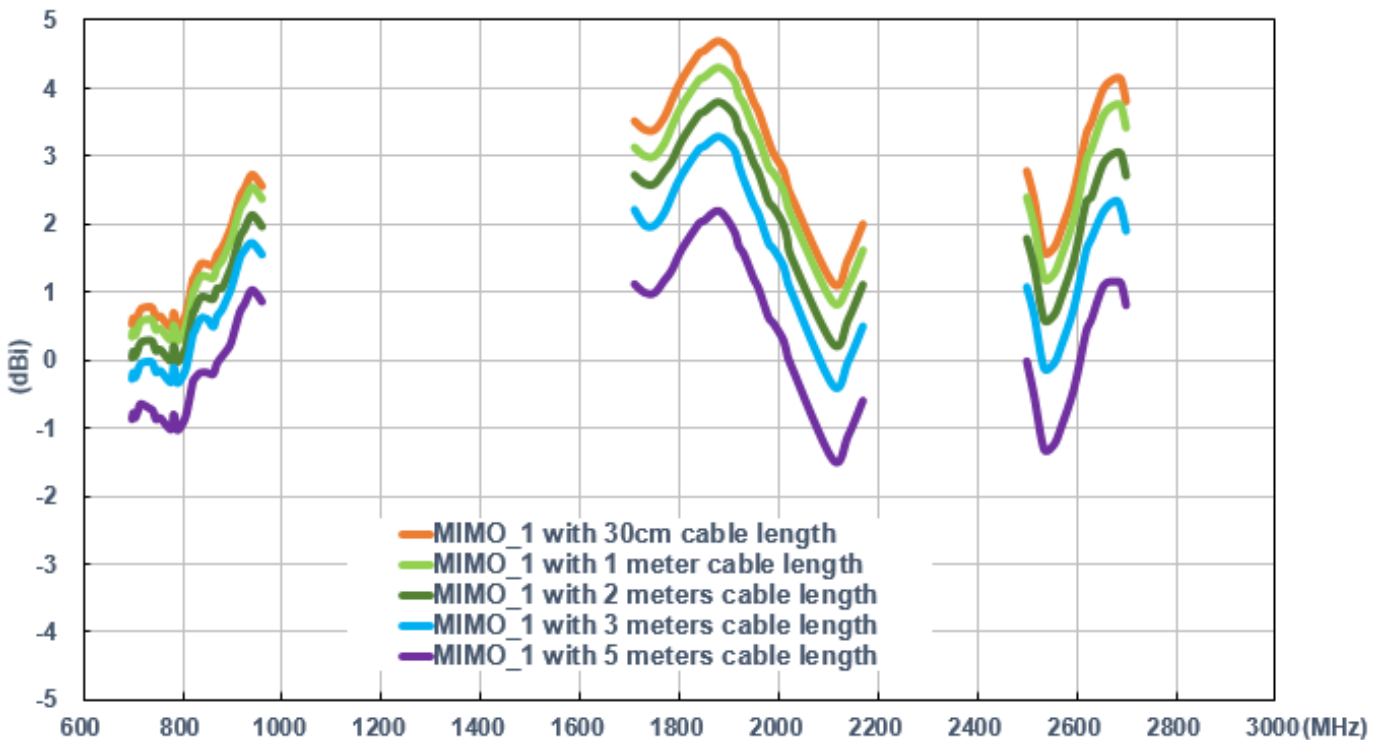

LTE MIMO 2

Return Loss

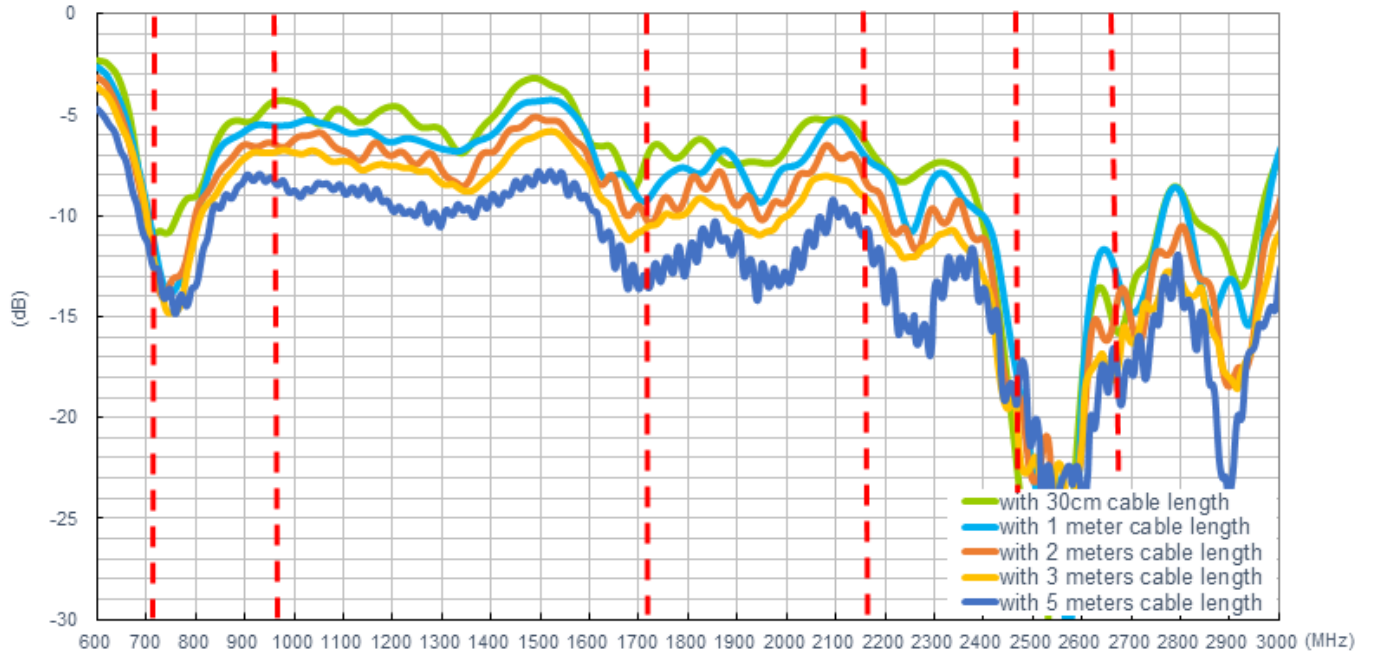

Efficiency

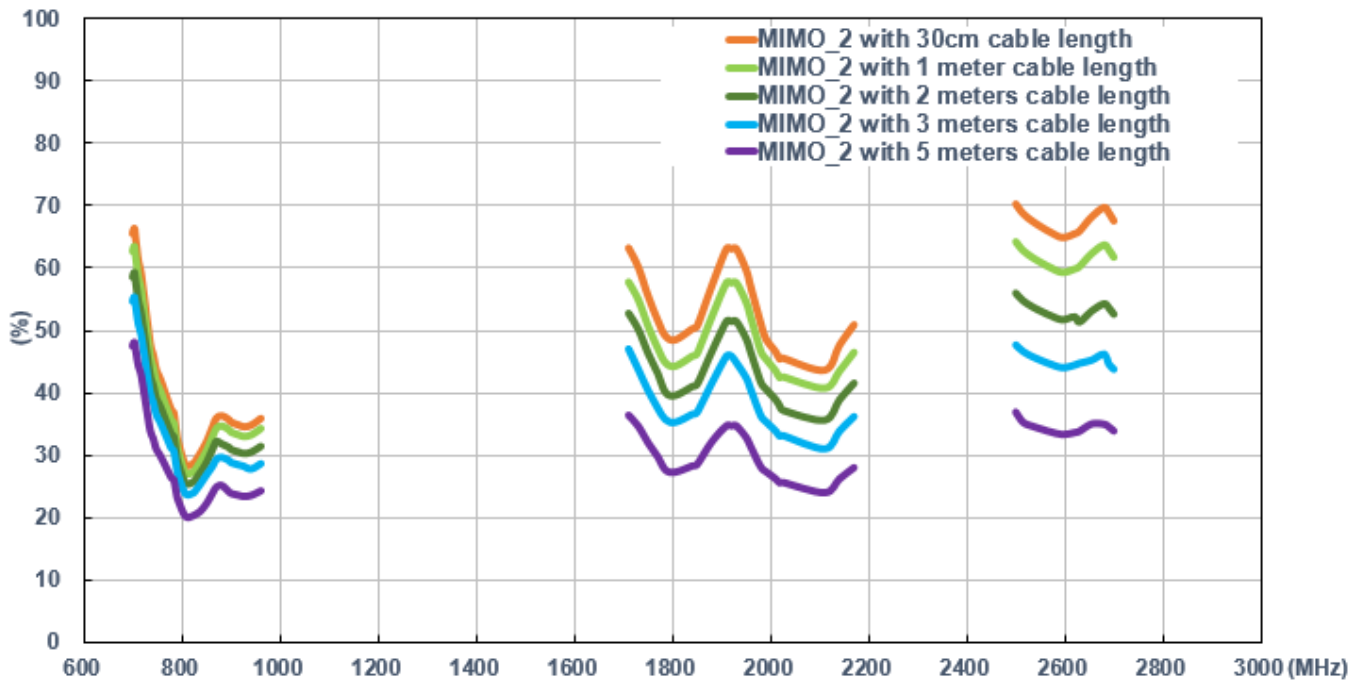

Average Gain

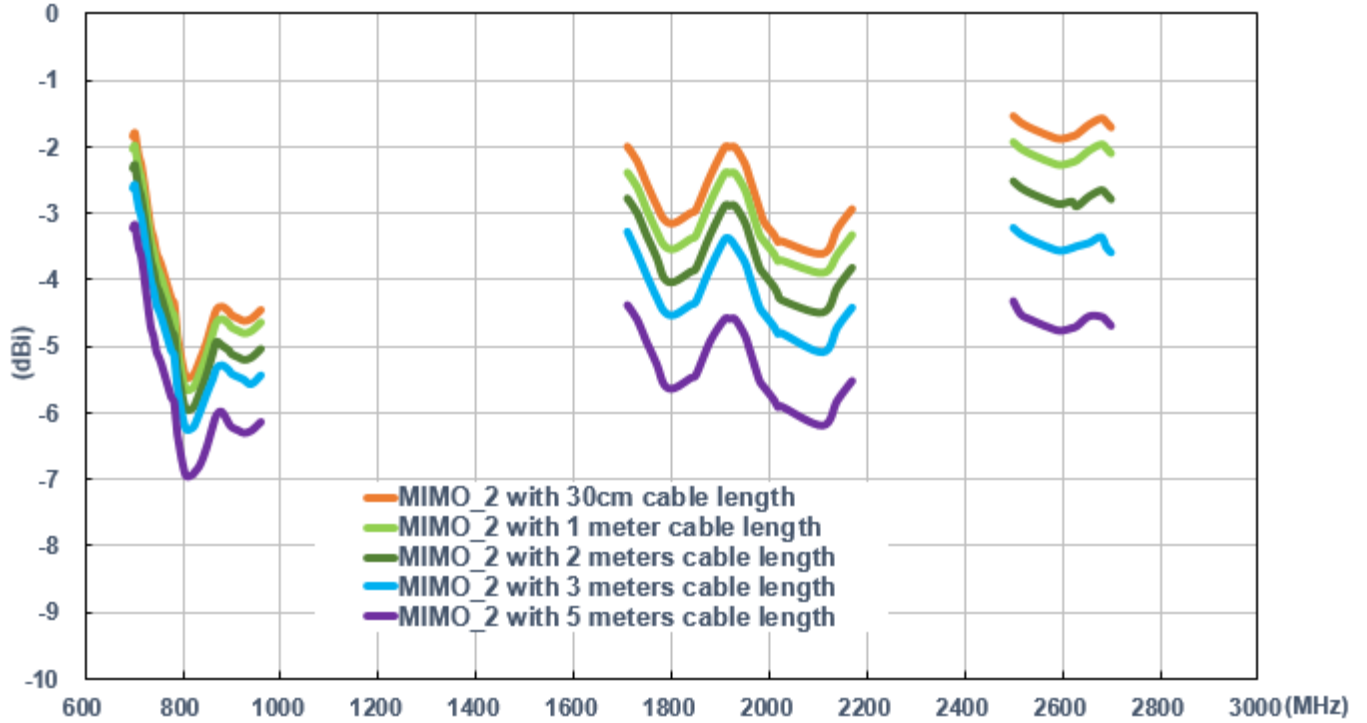

Peak Gain

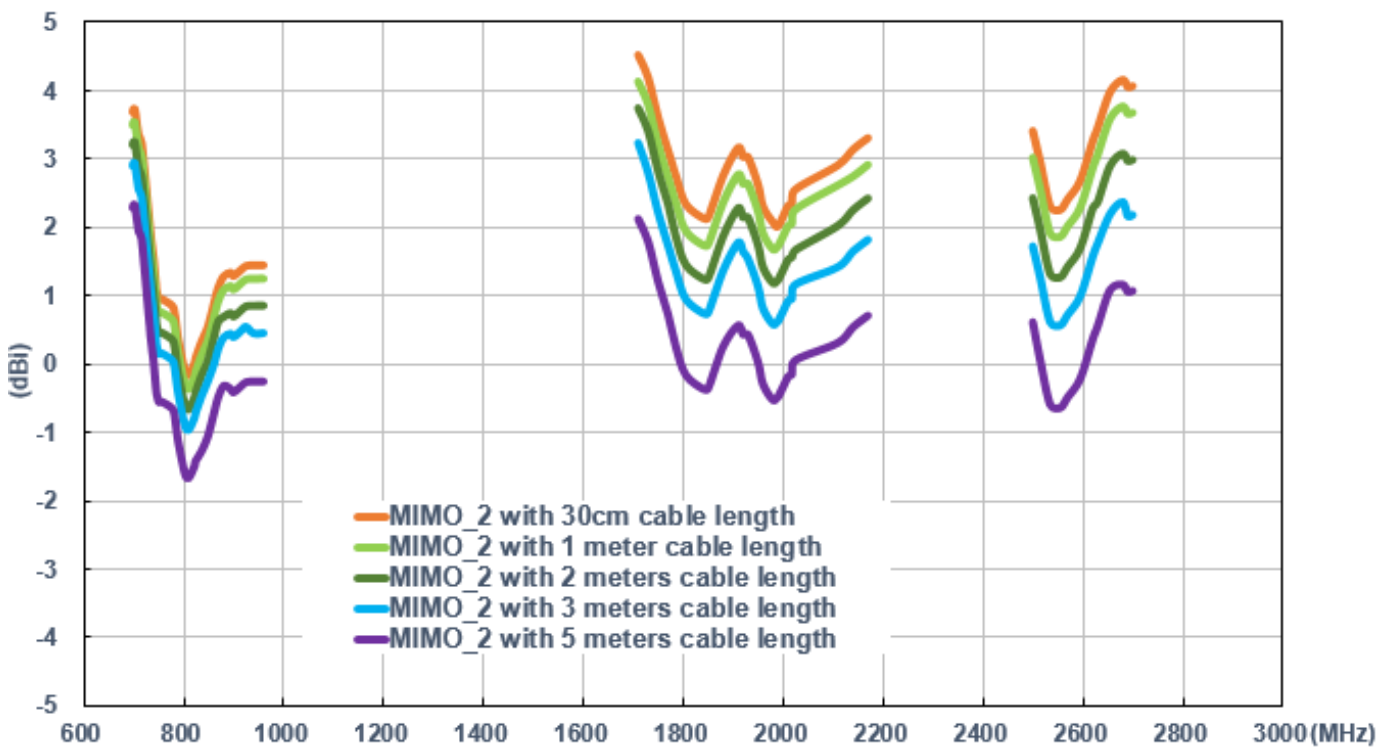

Isolation of MIMO 1 and MIMO 2

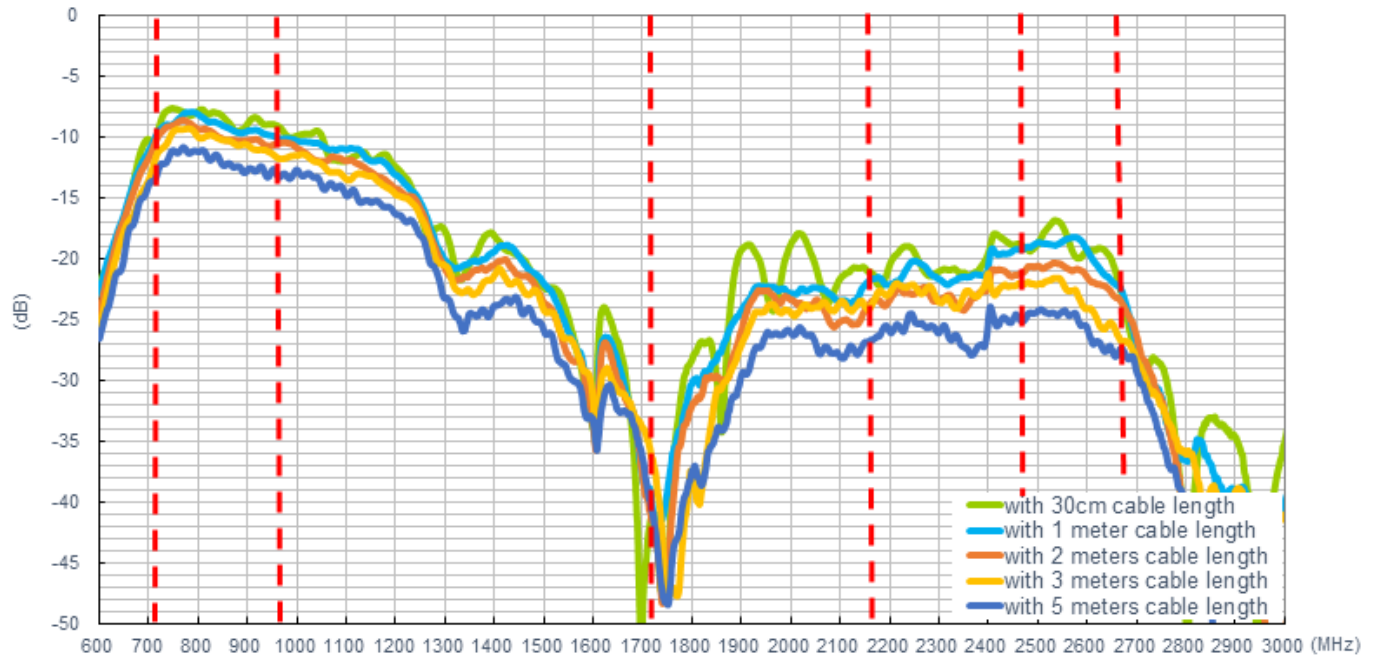

On 2mm ABS

LTE MIMO 1

Return Loss

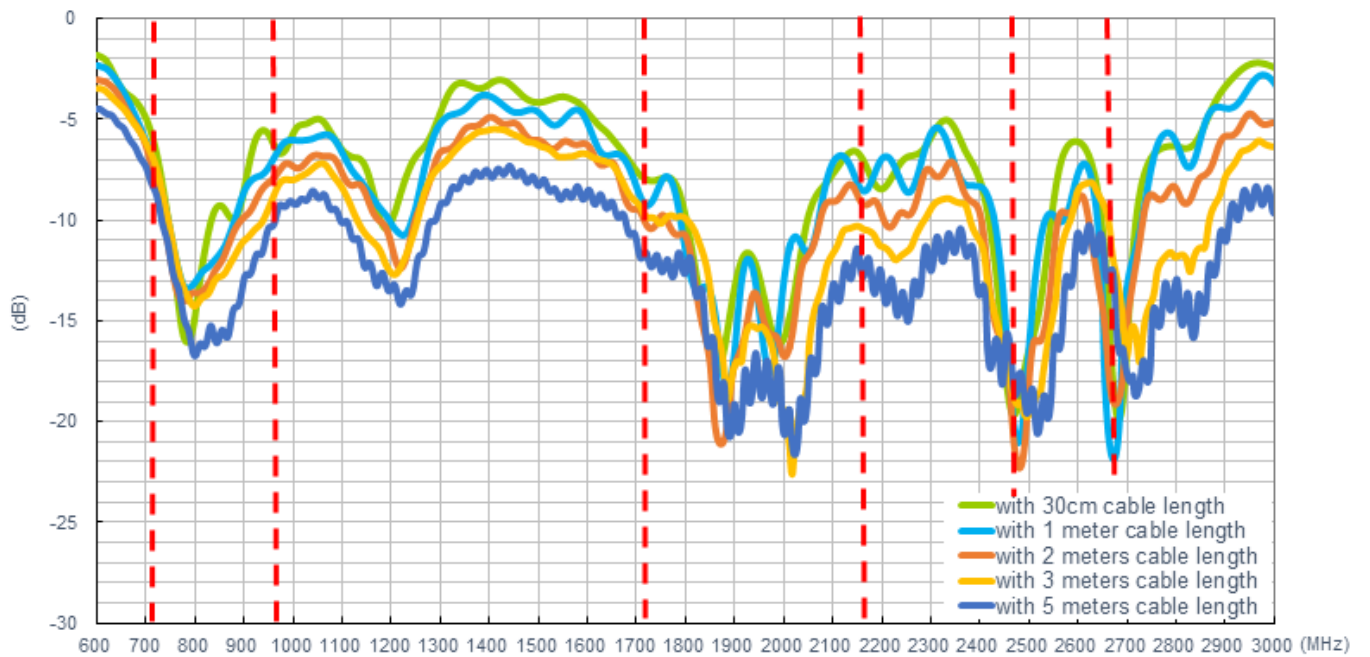

Efficiency

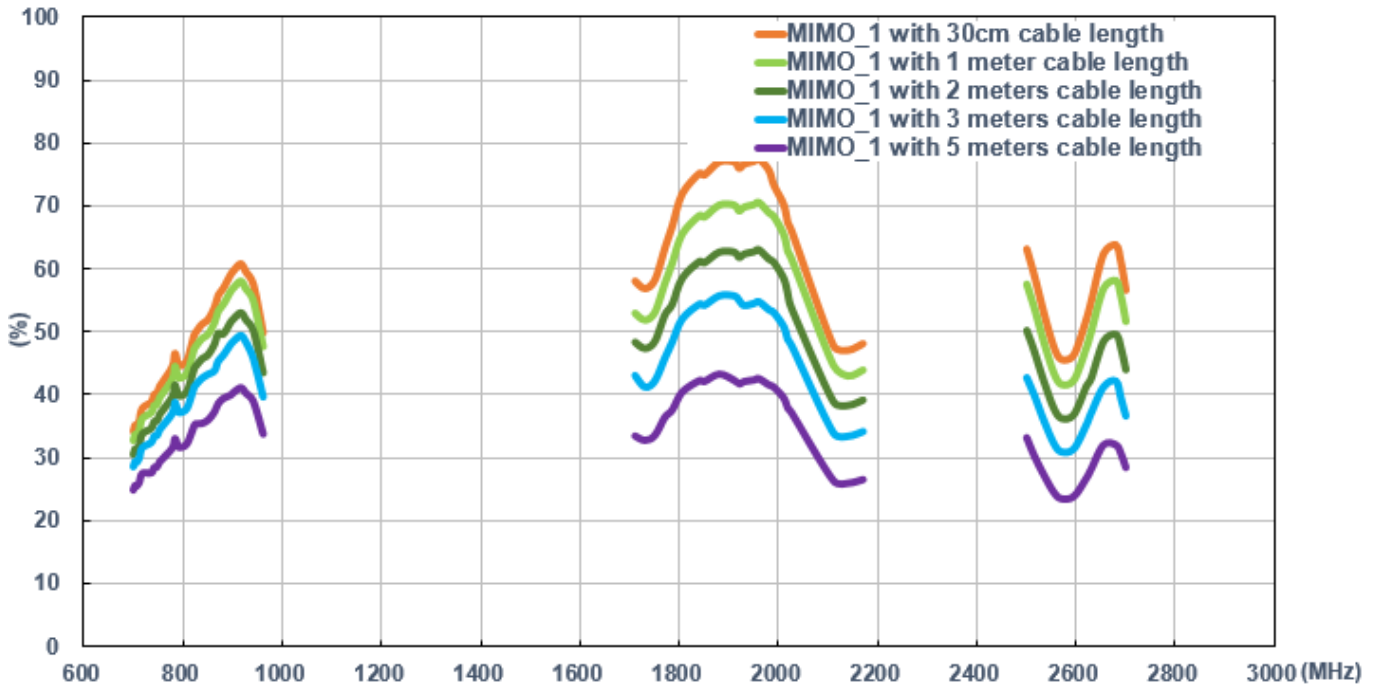

Average Gain

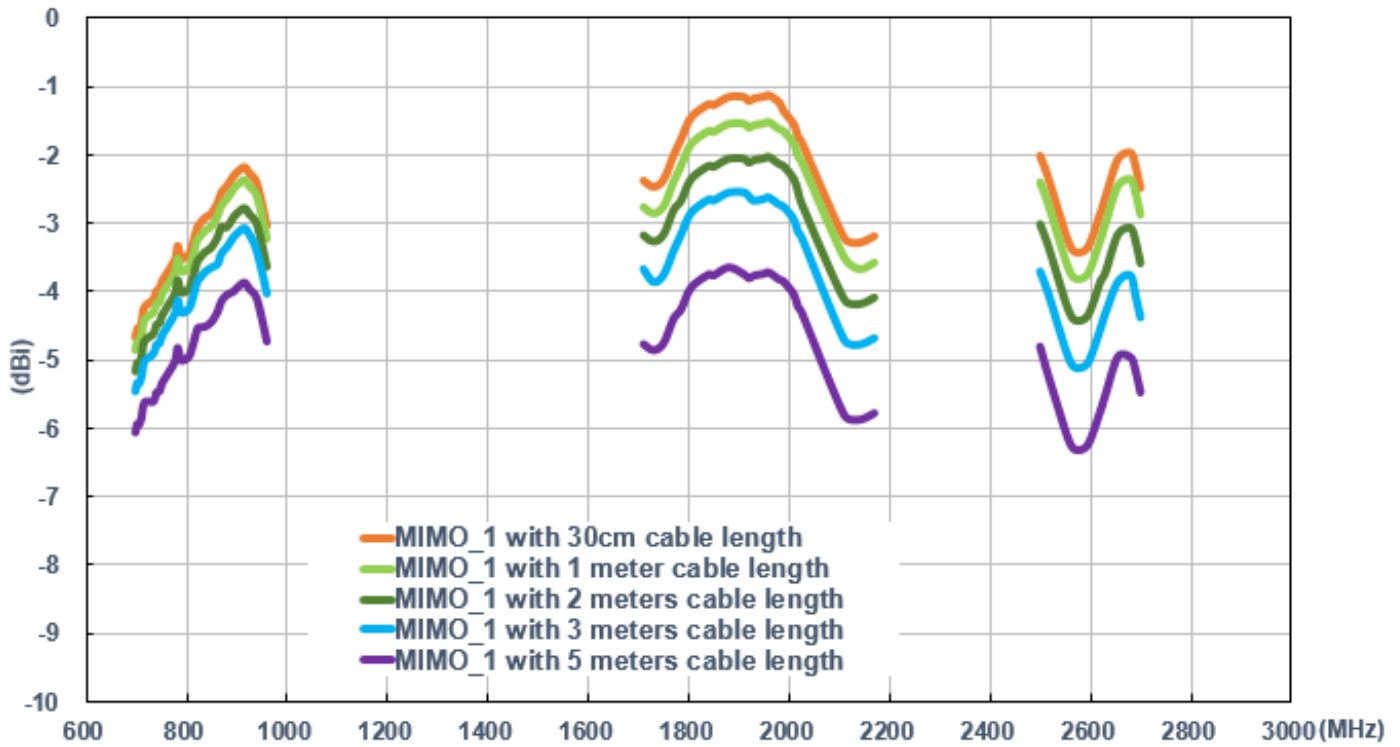

Peak Gain

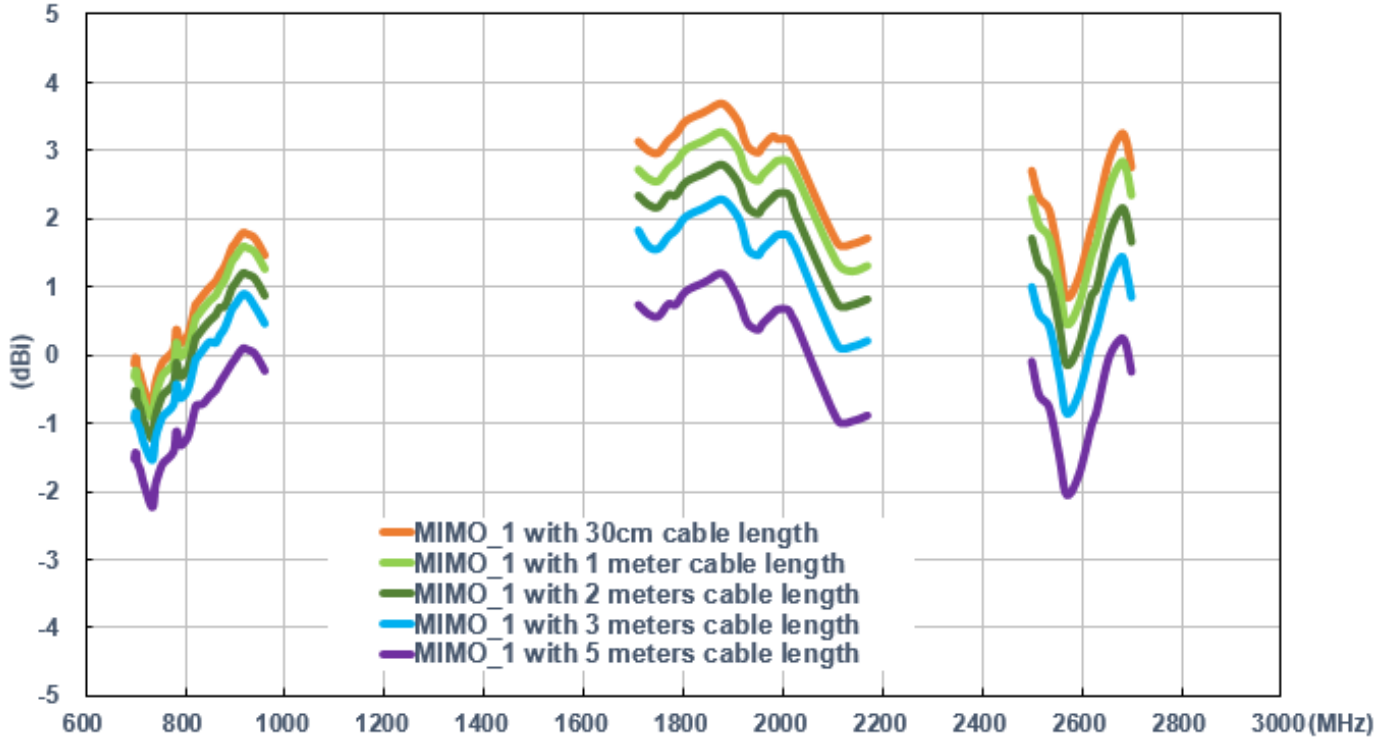

LTE MIMO 2

Return Loss

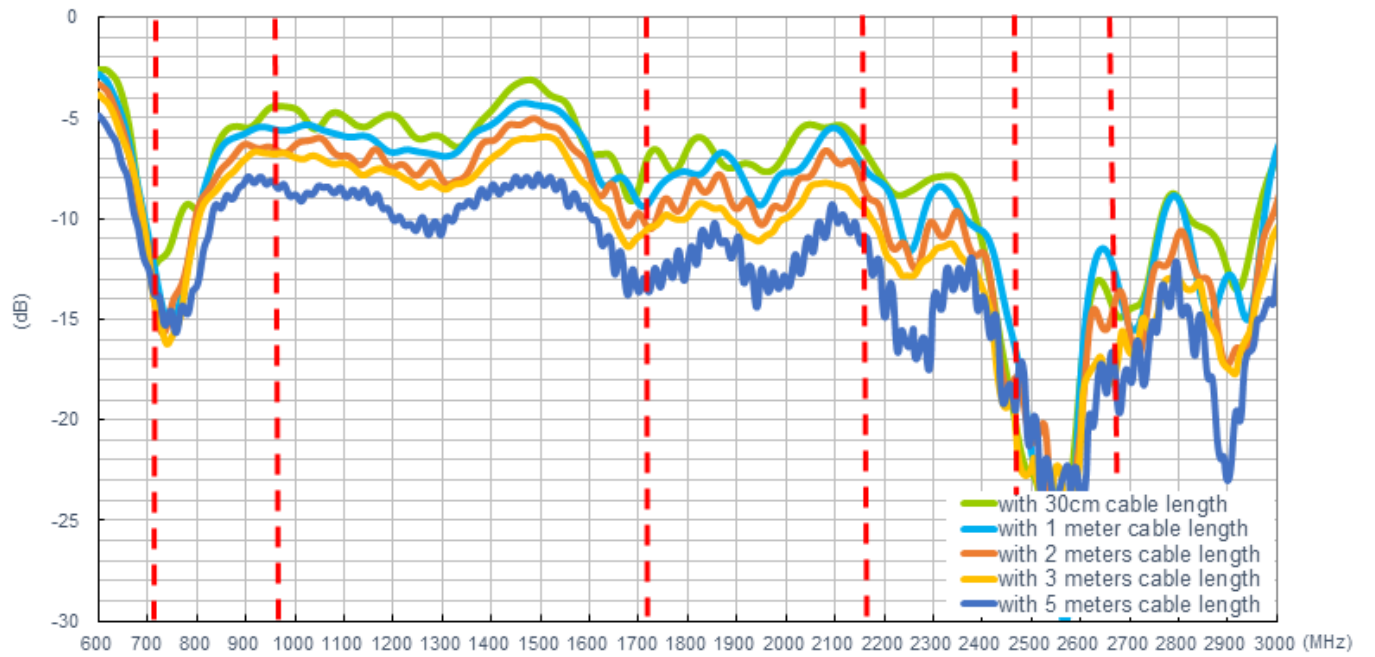

Efficiency

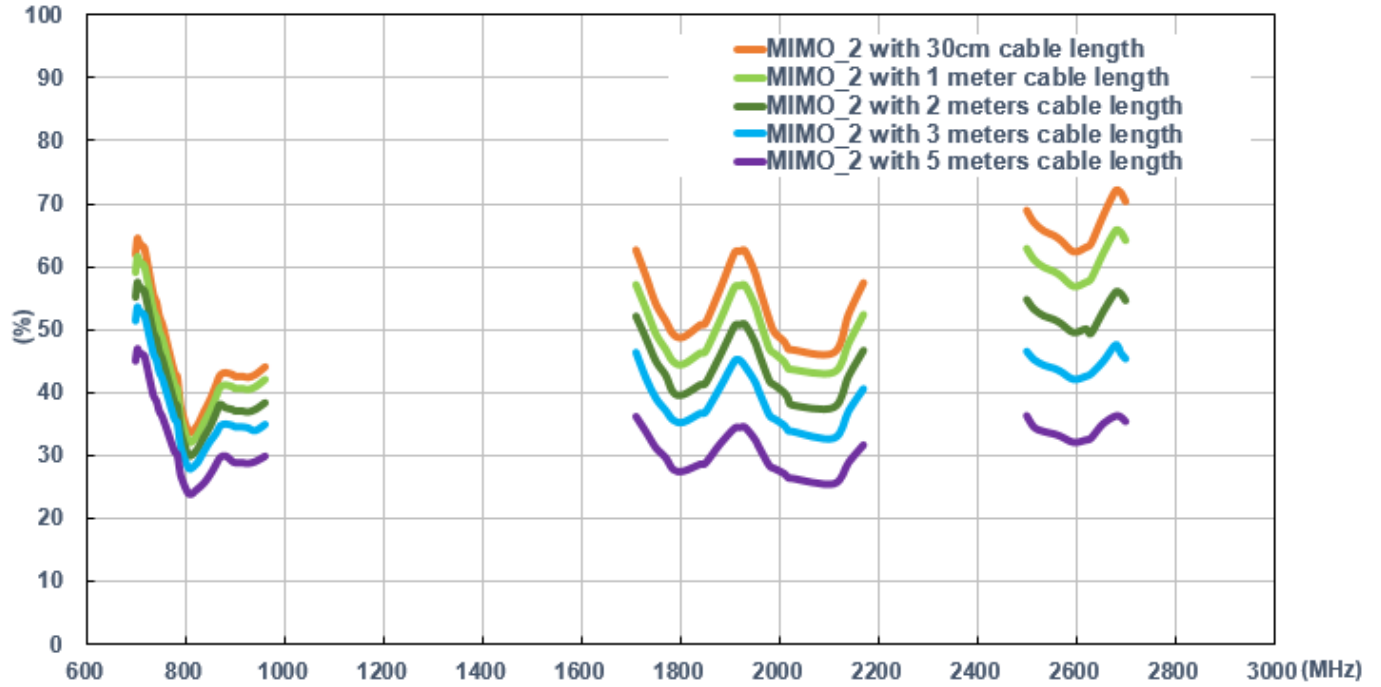

Average Gain

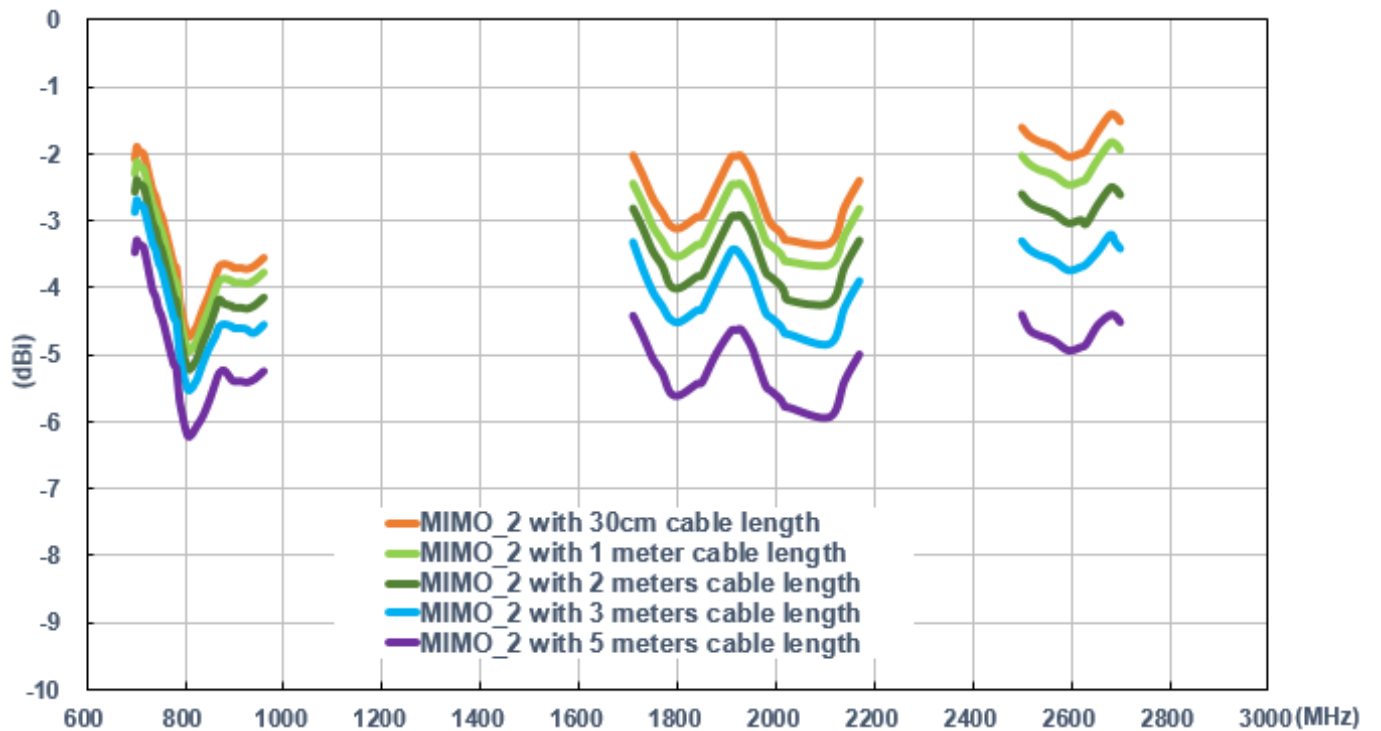

Peak Gain

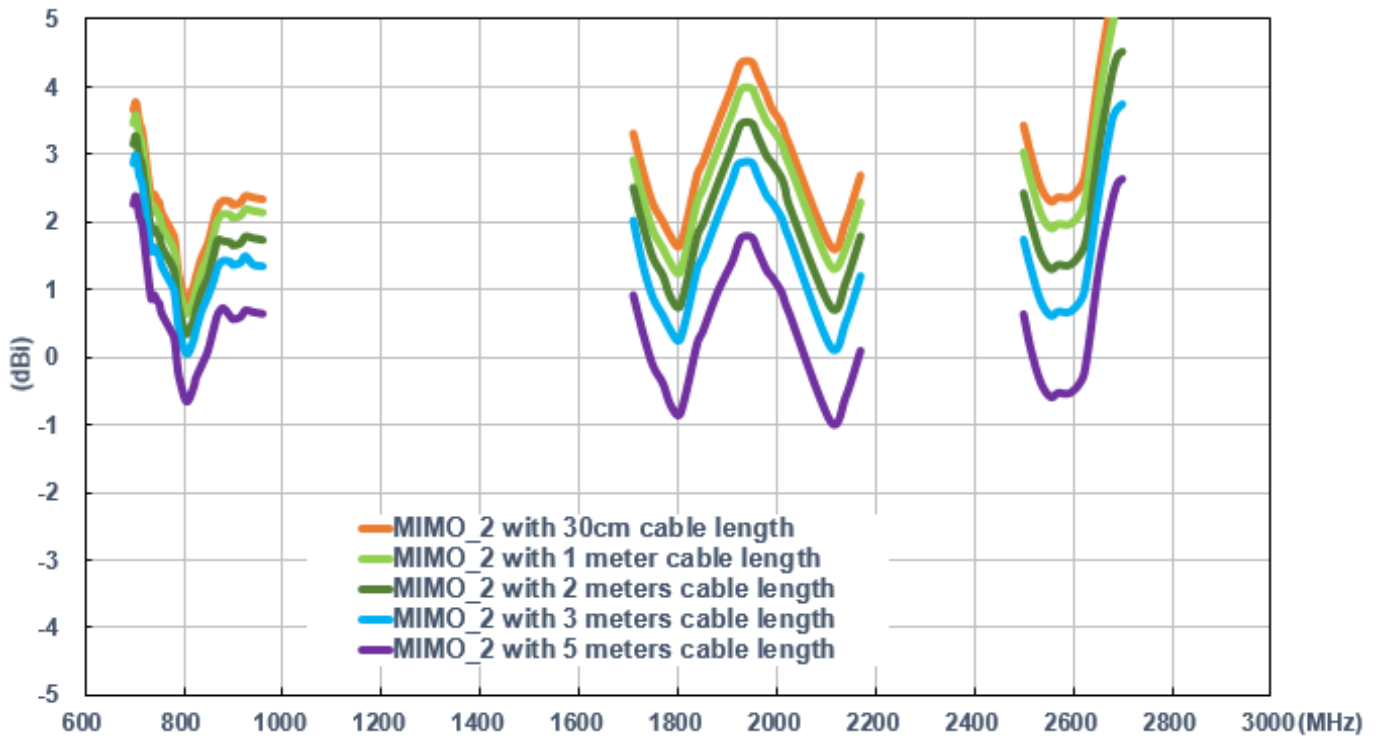

Isolation of MIMO 1 and MIMO 2

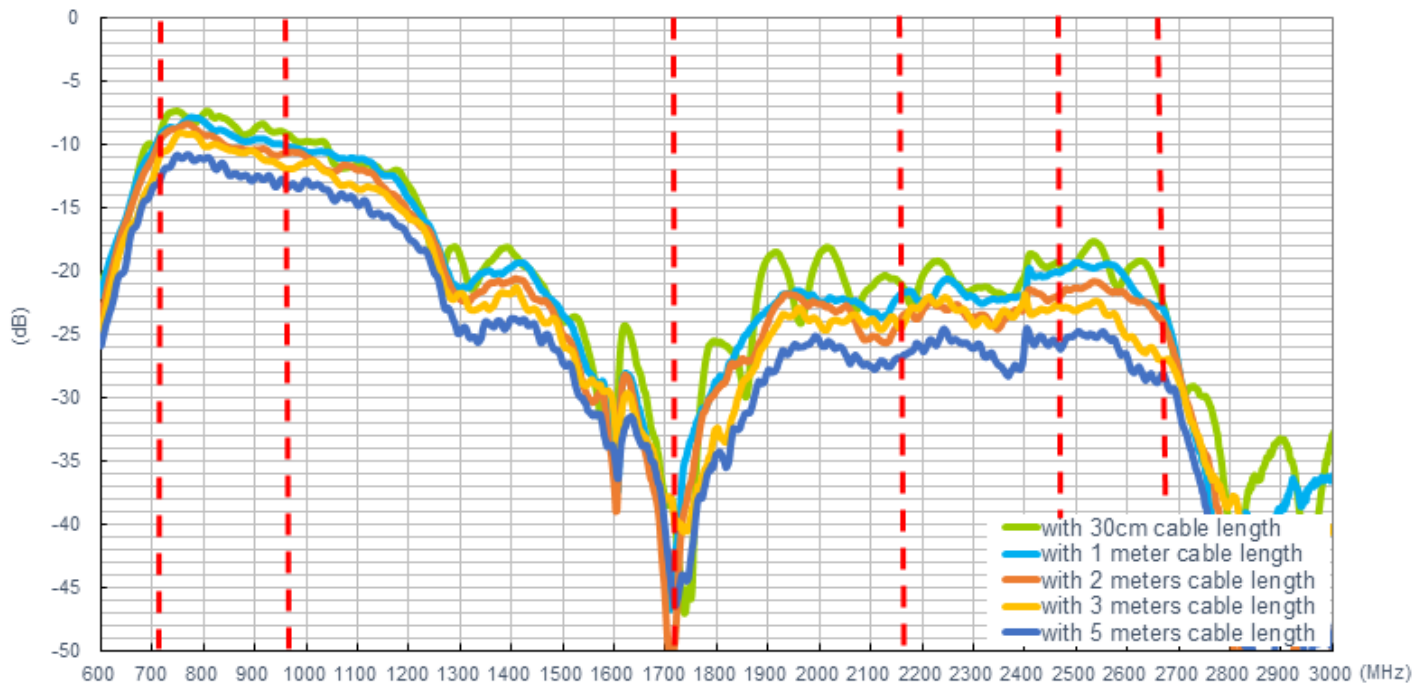

On glass base

LTE MIMO 1

Return Loss

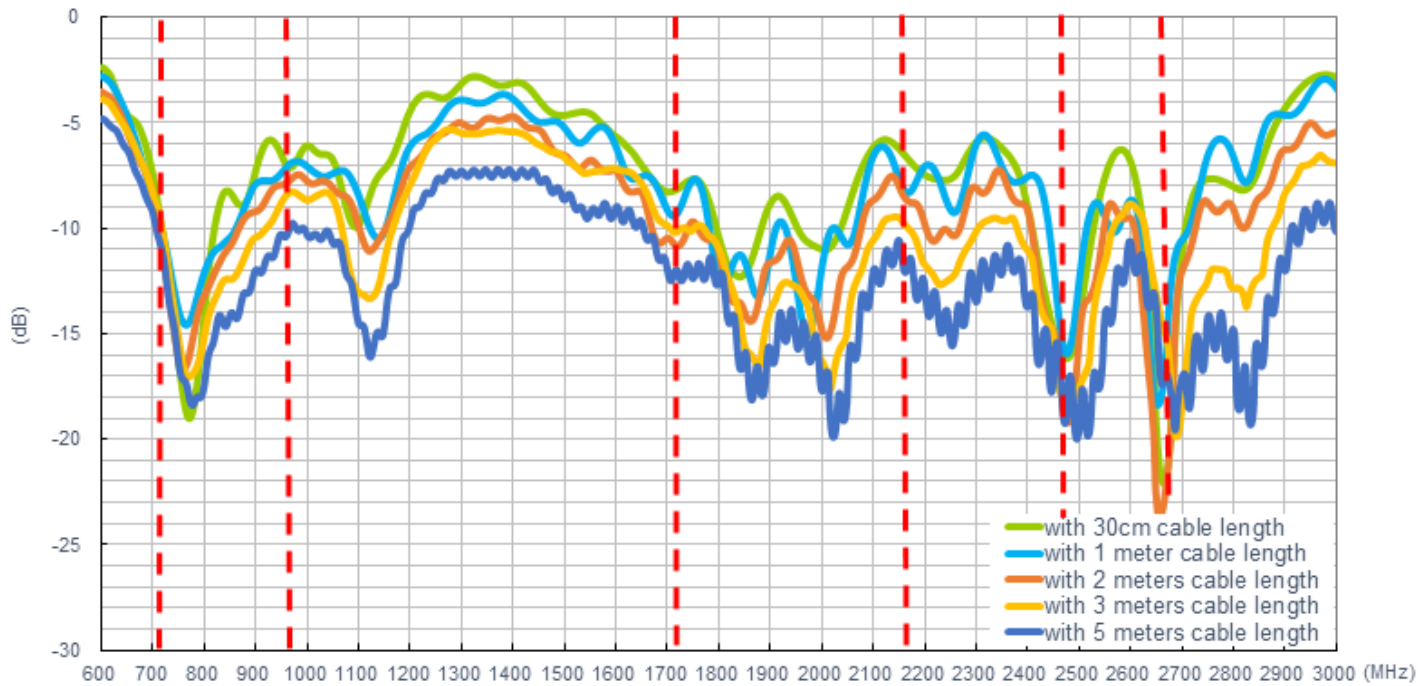

Efficiency

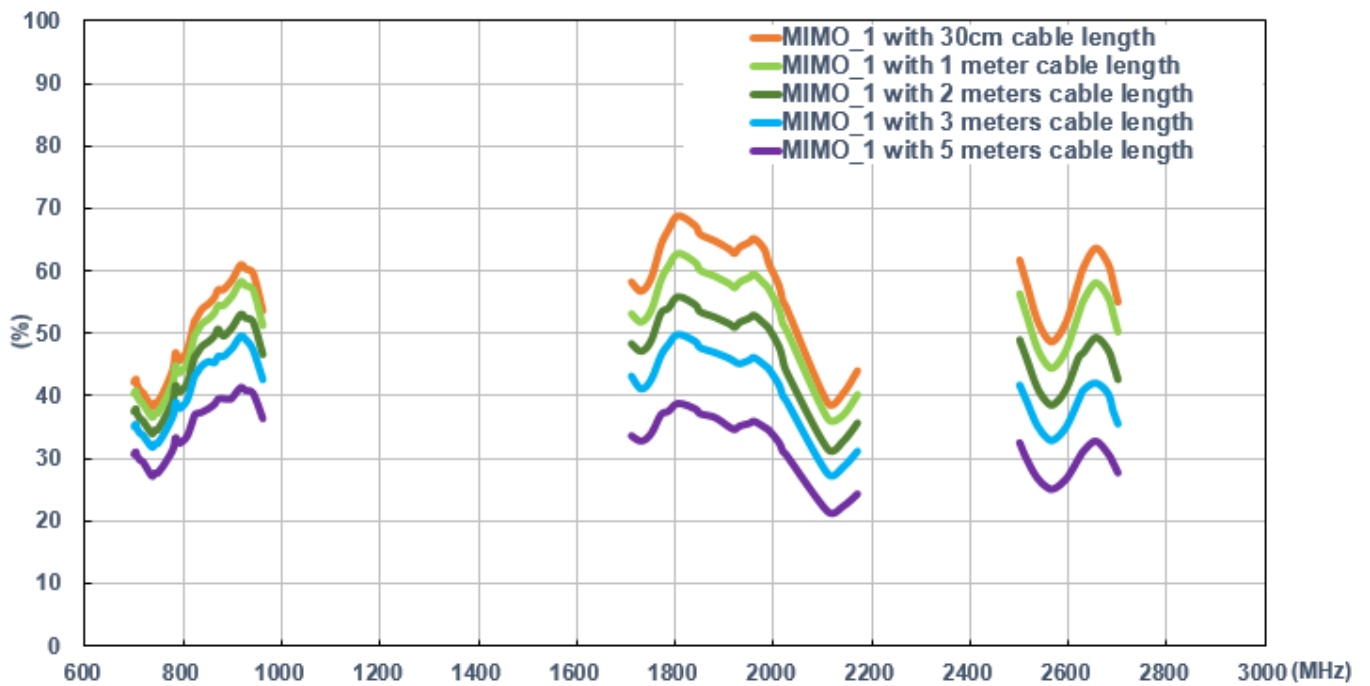

Average Gain

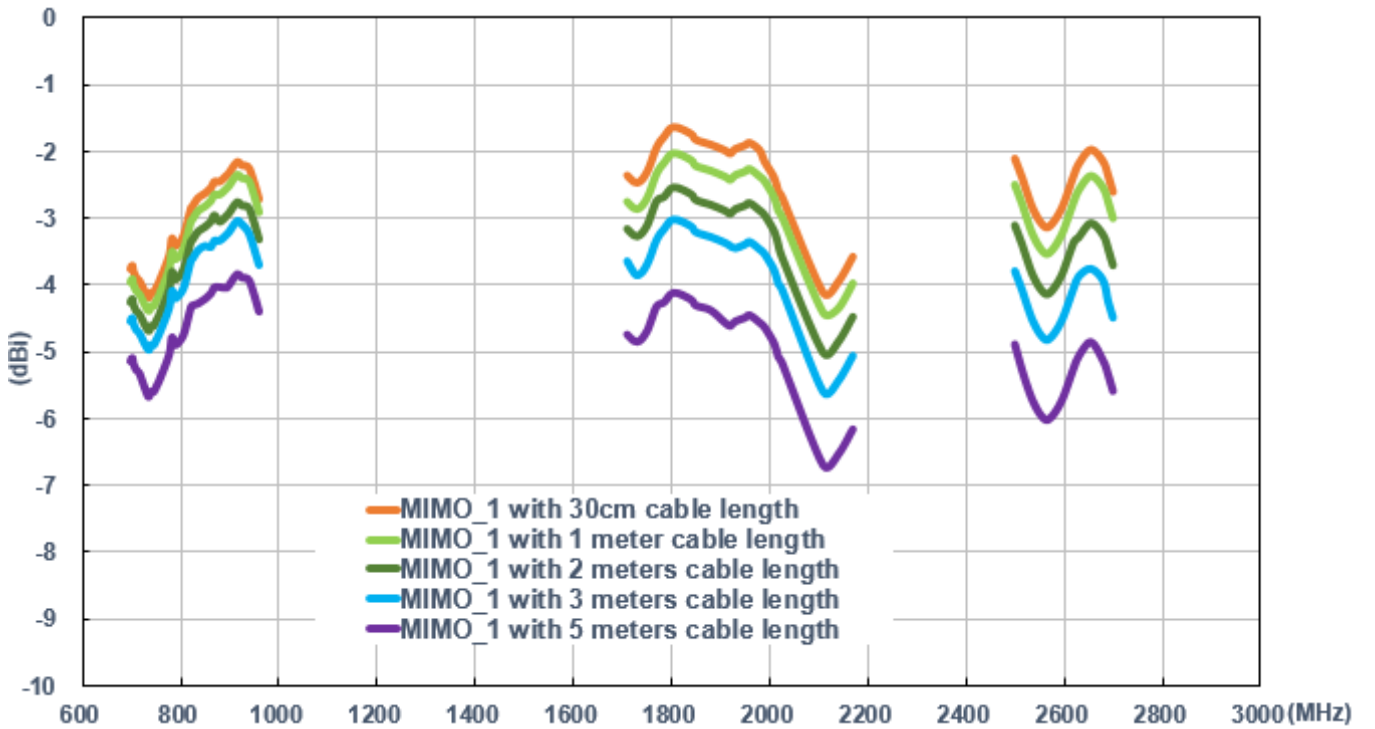

Peak Gain

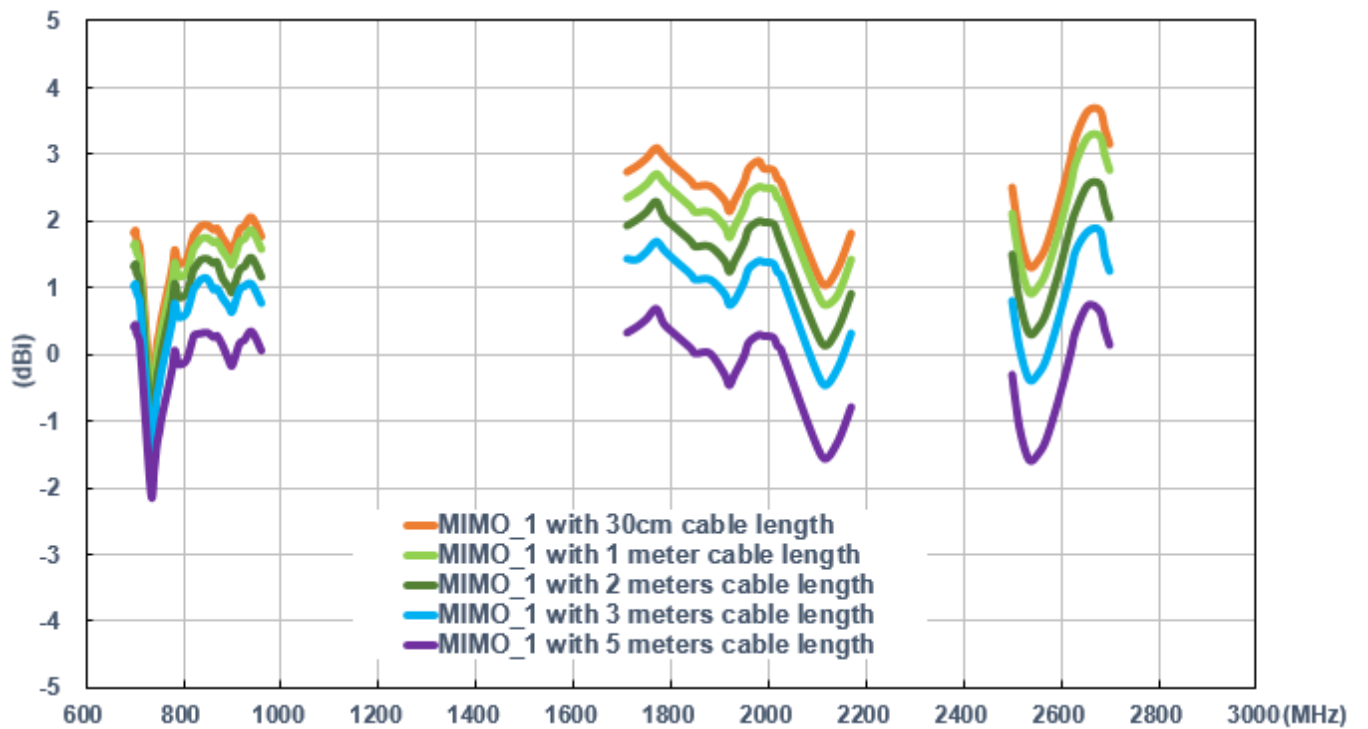

LTE MIMO 2

Return Loss

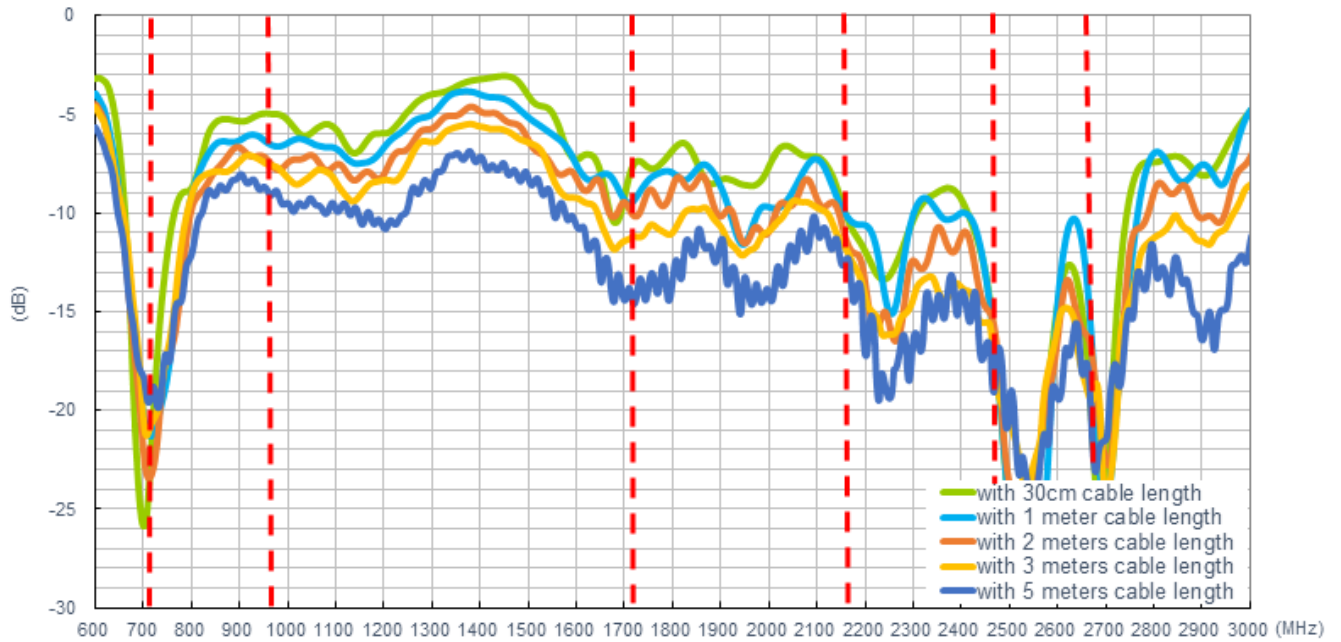

Efficiency

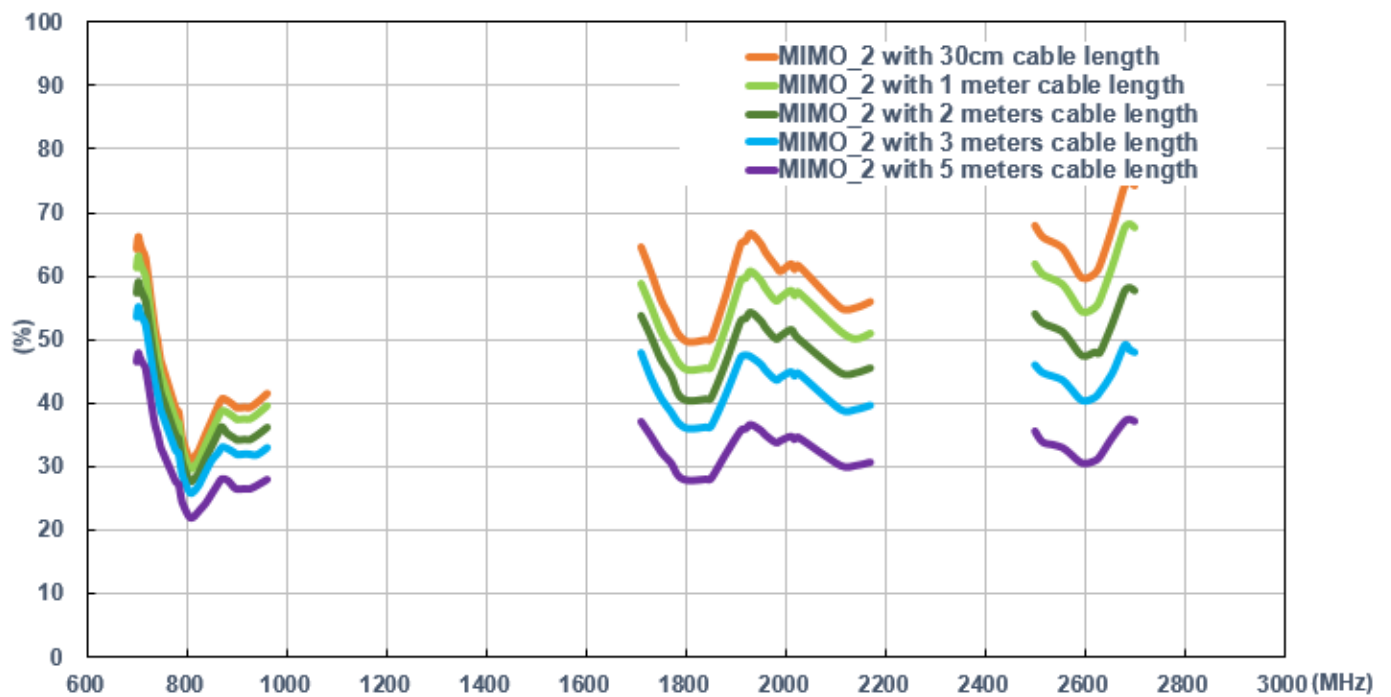

Average Gain

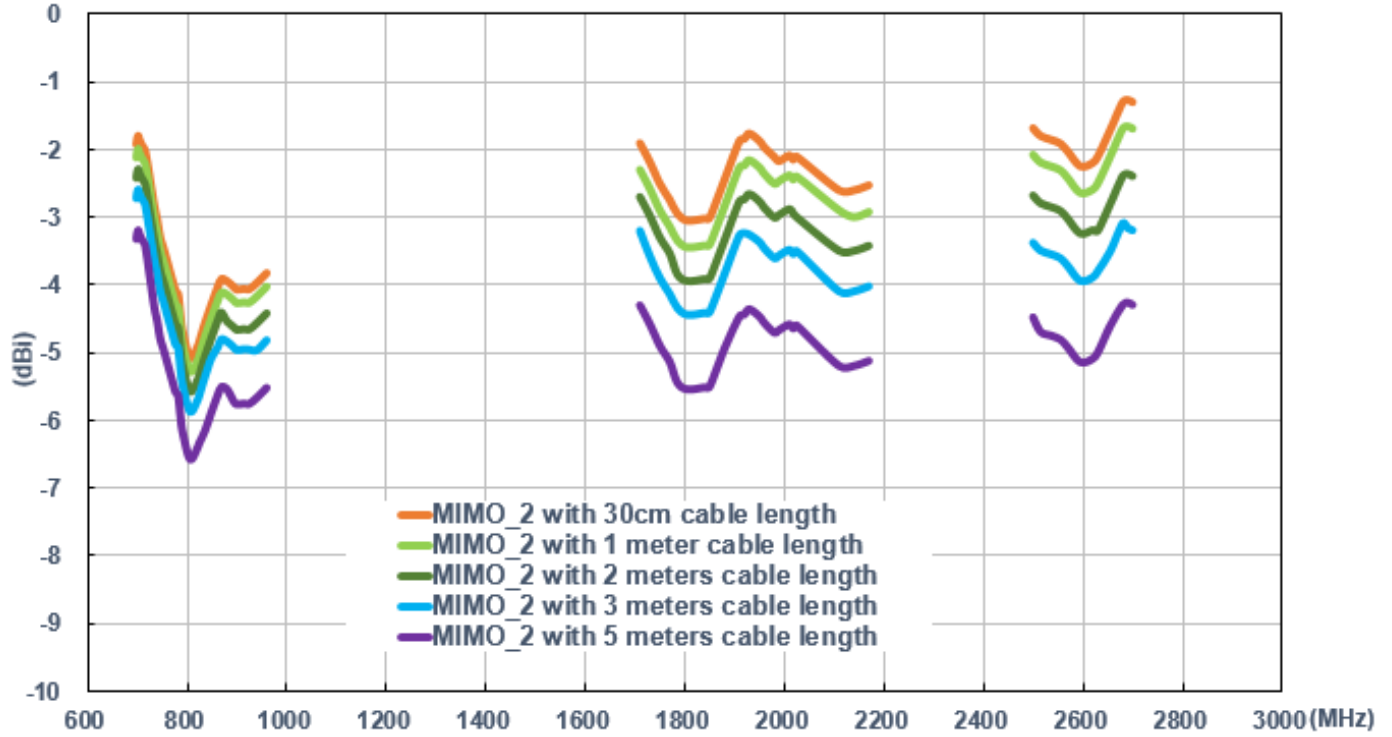

Peak Gain

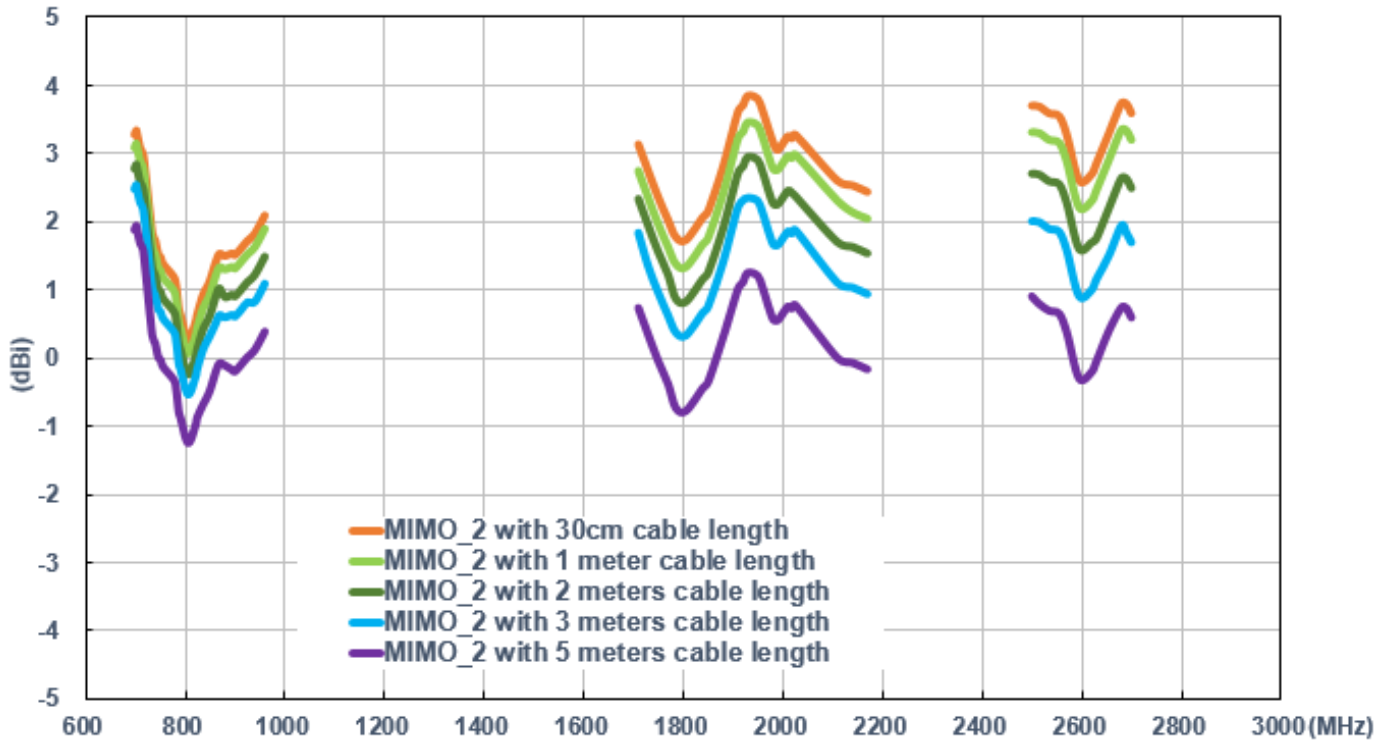

Isolation of MIMO 1 and MIMO 2

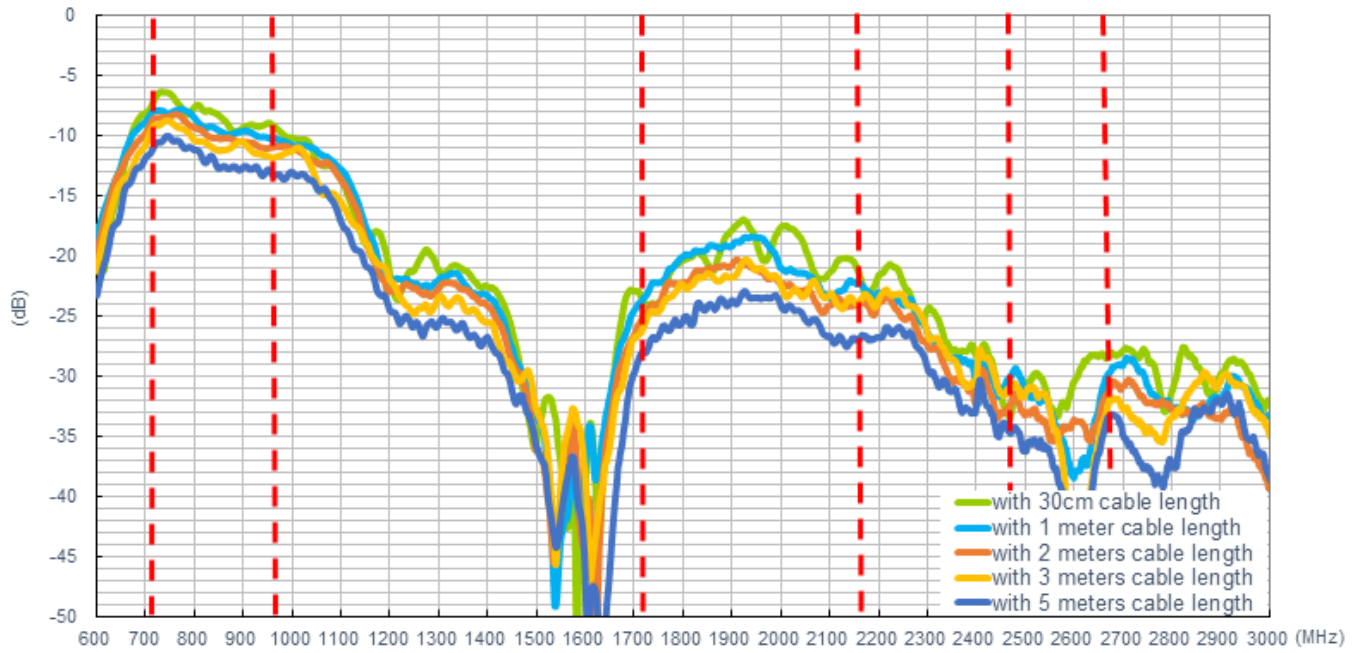

Taoglas makes no warranties based on the accuracy or completeness of the contents of this document and reserves the right to make changes to specifications and product descriptions at any time without notice.

Taoglas reserves the rights to this document and the information contained herein. Reproduction, use or disclosure to third parties without express permission is strictly prohibited.