

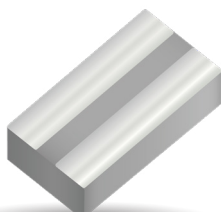

Surface Mount Ceramic Capacitor Products

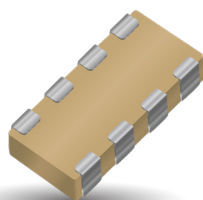
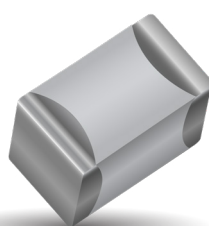
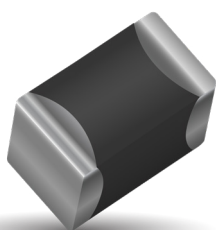
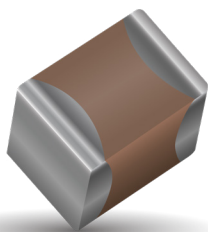

IMPORTANT INFORMATION/DISCLAIMER

All product specifications, statements, information and data (collectively, the “Information”) in this datasheet or made available on the website are subject to change. The customer is responsible for checking and verifying the extent to which the Information contained in this publication is applicable to an order at the time the order is placed. All Information given herein is believed to be accurate and reliable, but it is presented without guarantee, warranty, or responsibility of any kind, expressed or implied.

Statements of suitability for certain applications are based on AVX’s knowledge of typical operating conditions for such applications, but are not intended to constitute and AVX specifically disclaims any warranty concerning suitability for a specific customer application or use.

ANY USE OF PRODUCT OUTSIDE OF SPECIFICATIONS OR ANY STORAGE OR INSTALLATION INCONSISTENT WITH PRODUCT GUIDANCE VOIDS ANY WARRANTY.

The Information is intended for use only by customers who have the requisite experience and capability to determine the correct products for their application. Any technical advice inferred from this Information or otherwise provided by AVX with reference to the use of AVX’s products is given without regard, and AVX assumes no obligation or liability for the advice given or results obtained.

Although AVX designs and manufactures its products to the most stringent quality and safety standards, given the current state of the art, isolated component failures may still occur. Accordingly, customer applications which require a high degree of reliability or safety should employ suitable designs or other safeguards (such as installation of protective circuitry or redundancies) in order to ensure that the failure of an electrical component does not result in a risk of personal injury or property damage.

Unless specifically agreed to in writing, AVX has not tested or certified its products, services or deliverables for use in high risk applications including medical life support, medical device, direct physical patient contact, water treatment, nuclear facilities, weapon systems, mass and air transportation control, flammable environments, or any other potentially life critical uses. Customer understands and agrees that AVX makes no assurances that the products, services or deliverables are suitable for any high-risk uses. Under no circumstances does AVX warrant or guarantee suitability for any customer design or manufacturing process.

Although all product–related warnings, cautions and notes must be observed, the customer should not assume that all safety measures are indicated or that other measures may not be required.

Surface Mount Ceramic Capacitor Products



Table of Contents

How to Order

| | |
|------------------------------|---|
| Part Number Explanation..... | 1 |
|------------------------------|---|

C0G (NP0) Dielectric

| | |
|--------------------------------------|---|
| General Specifications..... | 3 |
| Specifications and Test Methods..... | 4 |
| Capacitance Range..... | 5 |

U Dielectric

| | |
|---|----|
| RF/Microwave C0G (NP0) Capacitors (RoHS) | |
| General Information..... | 7 |
| Capacitance Range..... | 8 |
| RF/Microwave C0G (NP0) Capacitors (Sn/Pb) | |
| General Information..... | 10 |
| Capacitance Range..... | 11 |
| RF/Microwave Automotive C0G (NP0) Capacitors (RoHS) | |
| AEC Q200 Qualified Ultra Low ESR..... | 12 |
| Designer Kits..... | 14 |

X8R/X8L Dielectric

| | |
|--------------------------------------|----|
| General Specifications..... | 15 |
| Specifications and Test Methods..... | 17 |

X7R Dielectric

| | |
|--------------------------------------|----|
| General Specifications..... | 18 |
| Specifications and Test Methods..... | 19 |
| Capacitance Range..... | 20 |

X7S Dielectric

| | |
|--------------------------------------|----|
| General Specifications..... | 22 |
| Specifications and Test Methods..... | 23 |
| Capacitance Range..... | 24 |

X5R Dielectric

| | |
|--------------------------------------|----|
| General Specifications..... | 25 |
| Specifications and Test Methods..... | 26 |
| Capacitance Range..... | 27 |

Y5V Dielectric

| | |
|--------------------------------------|----|
| General Specifications..... | 29 |
| Specifications and Test Methods..... | 30 |
| Capacitance Range..... | 31 |

MLCC Gold Termination – AU Series

| | |
|-----------------------------|----|
| General Specifications..... | 32 |
| Capacitance Range..... | 33 |

MLCC Tin/Lead Termination "B" (LD Series)

| | |
|---|----|
| C0G (NP0) – General Specifications..... | 39 |
| Specifications and Test Methods..... | 40 |
| Capacitance Range..... | 41 |
| X8R | |
| General Specifications..... | 43 |
| Specifications and Test Methods..... | 44 |
| Capacitance Range..... | 45 |
| X7R | |
| General Specifications..... | 46 |
| Specifications and Test Methods..... | 47 |
| Capacitance Range..... | 48 |
| X5R | |
| General Specifications..... | 50 |
| Specifications and Test Methods..... | 51 |
| Capacitance Range..... | 52 |

Automotive MLCC

| | |
|-----------------------------|----|
| General Specifications..... | 53 |
| Capacitance Range..... | 55 |

APS for COTS+ High Reliability Applications

| | |
|-----------------------------|----|
| General Specifications..... | 58 |
| Capacitance Range..... | 59 |

MLCC with FLEXITERM®

| | |
|--------------------------------------|----|
| General Specifications..... | 62 |
| Specifications and Test Methods..... | 63 |
| Capacitance Range..... | 65 |

FLEXISAFE MLC Chips

| | |
|---|----|
| General Specifications and Capacitance Range..... | 67 |
|---|----|

Capacitor Array

| | |
|---------------------------------------|----|
| Capacitor Array (IPC)..... | 68 |
| Automotive Capacitor Array (IPC)..... | 72 |
| Part & Pad Layout Dimensions..... | 73 |

Low Inductance Capacitors

| | |
|--|----|
| Introduction..... | 74 |
| LICC (Low Inductance Chip Capacitors)..... | 76 |
| IDC (InterDigitated Capacitors)..... | 80 |
| LGA Low Inductance Capacitors..... | 84 |

High Temperature MLCCs

| | |
|--------------------------------------|----|
| AT Series – 200°C & 250°C Rated..... | 87 |
|--------------------------------------|----|

High Voltage MLC Chips

| | |
|--|-----|
| For 600V to 5000V Applications..... | 93 |
| Tin/Lead Termination "B" - 600V to 5000V Applications..... | 98 |
| FLEXITERM® - 600V to 5000V Applications..... | 100 |
| For 600V to 3000V Automotive Applications - AEC-Q200..... | 105 |

MIL-PRF-55681/Chips

| | |
|-----------------------|-----|
| CDR01 thru CDR06..... | 107 |
| CDR31 thru CDR35..... | 109 |

MLCC Medical Applications

| | |
|----------------|-----|
| MM Series..... | 113 |
|----------------|-----|

Packaging of Chip Components

| | |
|-------|-----|
| | 118 |
|-------|-----|

Embossed Carrier Configuration

| | |
|-------|-----|
| | 119 |
|-------|-----|

Paper Carrier Configuration

| | |
|-------|-----|
| | 120 |
|-------|-----|

Basic Capacitor Formulas

| | |
|-------|-----|
| | 121 |
|-------|-----|

General Description

| | |
|-------|-----|
| | 122 |
|-------|-----|

Surface Mounting Guide

| | |
|-------|-----|
| | 127 |
|-------|-----|



How to Order

Part Number Explanation



Capacitor Array

EXAMPLE: W2A43C103MAT2A

| W | 2 | A | 4 | 3 | C | 103 | M | A | T | 2A |
|--------------------------------------|--|--------------|-----------------------|--|--|---|---|---|---|---|
| Style W = RoHS L = SnPb | Case Size 1 = 0405 2 = 0508 3 = 0612 | Array | Number of Caps | Voltage Z = 10V Y = 16V 3 = 25V 5 = 50V 1 = 100V | Dielectric A = NP0 C = X7R D = X5R | Capacitance Code (In pF) 2 Sig Digits + Number of Zeros | Capacitance Tolerance J = ±5% K = ±10% M = ±20% | Failure Rate A = Commercial 4 = Automotive | Termination Code T = Plated Ni and Sn Z = FLEXITERM® *B = 5% min lead *X = FLEXITERM® with 5% min lead | Packaging & Quantity Code 2A = 7" Reel (4000) 4A = 13" Reel (10000) 2F = 7" Reel (1000) |

NOTE: Contact factory for availability of Termination and Tolerance Options for Specific Part Numbers.

Low Inductance Capacitors (LICC)

EXAMPLE: 0612ZD105MAT2A

| 0612 | Z | D | 105 | M | A | T | 2 | A |
|--|--|---|--|--|--------------------------------|---|---|---|
| Size 0306 0508 0612 *LD16 *LD17 *LD18 | Voltage 6 = 6.3V Z = 10V Y = 16V 3 = 25V 5 = 50V | Dielectric C = X7R D = X5R | Capacitance Code (In pF) 2 Sig. Digits + Number of Zeros | Capacitance Tolerance K = ±10% M = ±20% | Failure Rate A = N/A | Terminations T = Plated Ni and Sn *B = 5% min lead | Packaging Available 2 = 7" Reel 4 = 13" Reel | Thickness See Page 97 for Codes |

NOTE: Contact factory for availability of Termination and Tolerance Options for Specific Part Numbers.

Interdigitated Capacitors (IDC)

EXAMPLE: W3L16D225MAT3A

| W | 3 | L | 1 | 6 | D | 225 | M | A | T | 3 | A |
|--------------------------------------|--|---|---|--|---|--|---|--------------------------------|--|---|---|
| Style W = RoHS L = SnPb | Case Size 2 = 0508 3 = 0612 | Low Inductance ESL = 50pH ESL = 60pH | Number of Terminals 1 = 8 Terminals | Voltage 4 = 4V 6 = 6.3V Z = 10V Y = 16V | Dielectric C = X7R D = X5R | Capacitance Code (In pF) 2 Sig. Digits + Number of Zeros | Capacitance Tolerance M = ±20 | Failure Rate A = N/A | Termination T = Plated Ni and Sn *B = 5% min lead | Packaging Available 1 = 7" Reel 3 = 13" Reel | Thickness Max. Thickness mm (in.) A = 0.95 (0.037) S = 0.55 (0.022) |

NOTE: Contact factory for availability of Termination and Tolerance Options for Specific Part Numbers.

Low Inductance Decoupling Capacitor Arrays (LICA)

EXAMPLE: LICA3T183M3FC4AA

| LICA | 3 | T | 102 | M | 3 | F | C | 4 | A | A |
|---|----------------|--|---|---|---|--|---|---|---|--|
| Style & Size 5V = 9 10V = Z 25V = 3 | Voltage | Dielectric D = X5R T = T55T S = High K T55T | Cap/Section (EIA Code) 102 = 1000 pF 103 = 10 nF 104 = 100 nF | Capacitance Tolerance M = ±20% P = GMV | Height Code 6 = 0.500mm 3 = 0.650mm 1 = 0.875mm 5 = 1.100mm 7 = 1.600mm | Termination *F = C4 Solder Balls-97Pb/3Sn H = C4 Solder Balls-Low ESR P = Cr-Cu-Au N = Cr-Ni-Au X = None | Reel Packaging M = 7" Reel R = 13" Reel 6 = 2"x2" Waffle Pack 8 = 2"x2" Black Waffle Pack 7 = 2"x2" Waffle Pack w/termination facing up A = 2"x2" Black Waffle Pack w/termination facing up C = 4"x4" Waffle Pack w/clear lid | # of Caps/Part 1 = one 2 = two 4 = four | Inspection Code A = Standard B = Established Reliability Testing | Code Face A = Bar B = No Bar C = Dot, S55S Dielectrics D = Triangle |

*** Not RoHS Compliant**



NOTE: Contact factory for availability of Termination and Tolerance Options for Specific Part Numbers.



COG (NP0) Dielectric

General Specifications

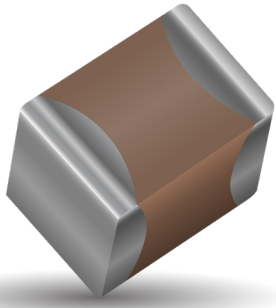

COG (NP0) is the most popular formulation of the “temperature-compensating,” EIA Class I ceramic materials. Modern COG (NP0) formulations contain neodymium, samarium and other rare earth oxides.

COG (NP0) ceramics offer one of the most stable capacitor dielectrics available. Capacitance change with temperature is $0 \pm 30\text{ppm}/^\circ\text{C}$ which is less than $\pm 0.3\%$ C from -55°C to $+125^\circ\text{C}$. Capacitance drift or hysteresis for COG (NP0) ceramics is negligible at less than $\pm 0.05\%$ versus up to $\pm 2\%$ for films. Typical capacitance change with life is less than $\pm 0.1\%$ for COG (NP0), one-fifth that shown by most other dielectrics. COG (NP0) formulations show no aging characteristics.

PART NUMBER (see page 4 for complete part number explanation)



| | | | | | | | | |
|--------------------------|--|------------------------------------|---|--|---|---|---|---|
| 0805 | 5 | A | 101 | J | A | T | 2 | A |
| Size (L" x W") | Voltage 6.3V = 6 10V = Z 16V = Y 25V = 3 50V = 5 100V = 1 200V = 2 250V = V 500V = 7 | Dielectric COG (NP0) = A | Capacitance Code (In pF) 2 Sig. Digits + Number of Zeros | Capacitance Tolerance B = ± 10 pF (<10pF) C = ± 25 pF (<10pF) D = ± 50 pF (<10pF) F = $\pm 1\%$ (≥ 10 pF) G = $\pm 2\%$ (≥ 10 pF) J = $\pm 5\%$ K = $\pm 10\%$ | Failure Rate A = Not Applicable | Terminations T = Plated Ni and Sn Contact Factory For 1 = Pd/Ag Term 7 = Gold Plated NOT RoHS COMPLIANT | Packaging 2 = 7" Reel 4 = 13" Reel U = 4mm TR (01005) | Special Code A = Std. Product Contact Factory For Multiples |

NOTE: Contact factory for availability of Termination and Tolerance Options for Specific Part Numbers. Contact factory for non-specified capacitance values.

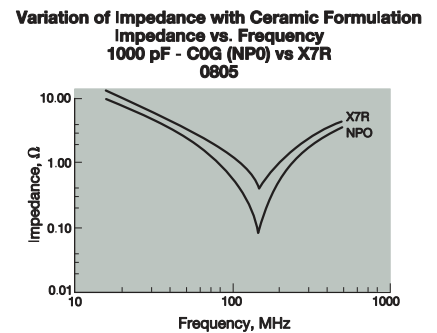
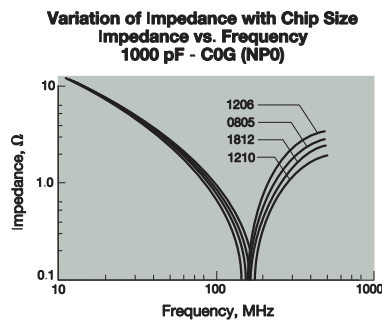
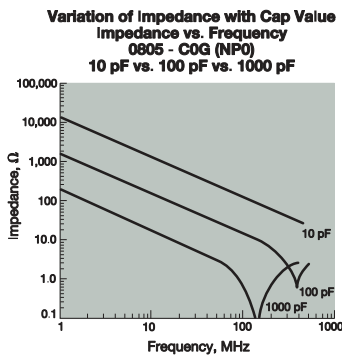
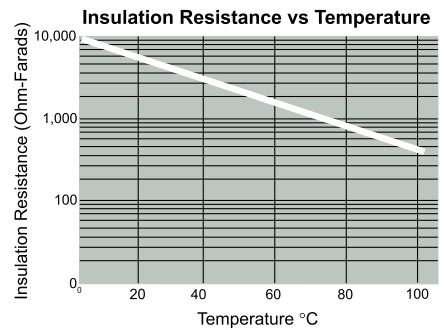
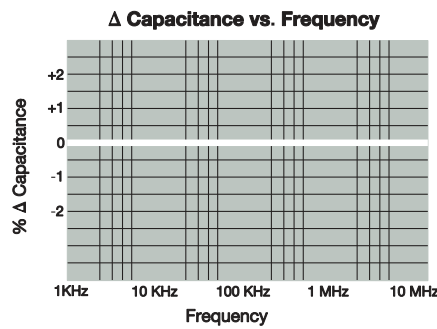
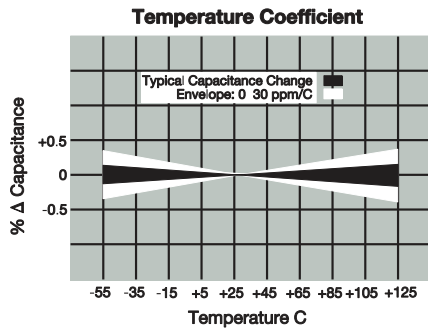

COG (NP0) Dielectric

Specifications and Test Methods

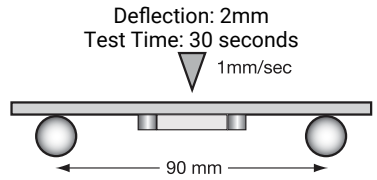
| Parameter/Test | | NP0 Specification Limits | Measuring Conditions | |
|--------------------------------|-----------------------|---|--|----------------|
| Operating Temperature Range | | -55°C to +125°C | Temperature Cycle Chamber | |
| Capacitance | | Within specified tolerance | Freq.: 1.0 MHz ± 10% for cap ≤ 1000 pF 1.0 kHz ± 10% for cap > 1000 pF Voltage: 1.0Vrms ± .2V | |
| Q | | <30 pF: Q ≥ 400+20 x Cap Value ≥30 pF: Q ≥ 1000 | | |
| Insulation Resistance | | 100,000MΩ or 1000MΩ - μF, whichever is less | Charge device with rated voltage for 60 ± 5 secs @ room temp/humidity | |
| Dielectric Strength | | No breakdown or visual defects | Charge device with 250% of rated voltage for 1-5 seconds, w/charge and discharge current limited to 50 mA (max) Note: Charge device with 150% of rated voltage for 500V devices. | |
| Resistance to Flexure Stresses | Appearance | No defects |  <p>Deflection: 2mm Test Time: 30 seconds 1mm/sec 90 mm</p> | |
| | Capacitance Variation | ±5% or ±.5 pF, whichever is greater | | |
| | Q | Meets Initial Values (As Above) | | |
| | Insulation Resistance | ≥ Initial Value x 0.3 | | |
| Solderability | | ≥ 95% of each terminal should be covered with fresh solder | Dip device in eutectic solder at 230 ± 5°C for 5.0 ± 0.5 seconds | |
| Resistance to Solder Heat | Appearance | No defects, <25% leaching of either end terminal | Dip device in eutectic solder at 260°C for 60sec- onds. Store at room temperature for 24 ± 2 hours before measuring electrical properties. | |
| | Capacitance Variation | ≤ ±2.5% or ±.25 pF, whichever is greater | | |
| | Q | Meets Initial Values (As Above) | | |
| | Insulation Resistance | Meets Initial Values (As Above) | | |
| | Dielectric Strength | Meets Initial Values (As Above) | | |
| Thermal Shock | Appearance | No visual defects | Step 1: -55°C ± 2° | 30 ± 3 minutes |
| | Capacitance Variation | ≤ ±2.5% or ±.25 pF, whichever is greater | Step 2: Room Temp | ≤ 3 minutes |
| | Q | Meets Initial Values (As Above) | Step 3: +125°C ± 2° | 30 ± 3 minutes |
| | Insulation Resistance | Meets Initial Values (As Above) | Step 4: Room Temp | ≤ 3 minutes |
| | Dielectric Strength | Meets Initial Values (As Above) | Repeat for 5 cycles and measure after 24 hours at room temperature | |
| Load Life | Appearance | No visual defects | Charge device with twice rated voltage in test chamber set at 125°C ± 2°C for 1000 hours (+48, -0). Remove from test chamber and stabilize at room temperature for 24 hours before measuring. | |
| | Capacitance Variation | ≤ ±3.0% or ± .3 pF, whichever is greater | | |
| | Q (C=Nominal Cap) | ≥ 30 pF: Q ≥ 350 ≥10 pF, <30 pF: Q ≥ 275 +5C/2 <10 pF: Q ≥ 200 +10C | | |
| | Insulation Resistance | ≥ Initial Value x 0.3 (See Above) | | |
| | Dielectric Strength | Meets Initial Values (As Above) | | |
| Load Humidity | Appearance | No visual defects | Store in a test chamber set at 85°C ± 2°C/ 85% ± 5% relative humidity for 1000 hours (+48, -0) with rated voltage applied. Remove from chamber and stabilize at room temperature for 24 ± 2 hours before measuring. | |
| | Capacitance Variation | ≤ ±5.0% or ± .5 pF, whichever is greater | | |
| | Q | ≥ 30 pF: Q ≥ 350 ≥10 pF, <30 pF: Q ≥ 275 +5C/2 <10 pF: Q ≥ 200 +10C | | |
| | Insulation Resistance | ≥ Initial Value x 0.3 (See Above) | | |
| | Dielectric Strength | Meets Initial Values (As Above) | | |

COG (NP0) Dielectric

Capacitance Range



PREFERRED SIZES ARE SHADED

| SIZE | 0101* | 0201 | 0402 | 0603 | 0805 | 1206 | |
|--------------|---------------------------------------|--------------------------------|--------------------------------|--------------------------------|--------------------------------|--------------------------------|------------------|
| Soldering | Reflow Only | Reflow Only | Reflow/Wave | Reflow/Wave | Reflow/Wave | Reflow/Wave | |
| Packaging | All Paper | All Paper | All Paper | All Paper | Paper/Embossed | Paper/Embossed | |
| (L) Length | mm 0.40 ± 0.02 (0.016 ± 0.0008) | 0.60 ± 0.09 (0.024 ± 0.004) | 1.00 ± 0.10 (0.040 ± 0.004) | 1.60 ± 0.15 (0.063 ± 0.006) | 2.01 ± 0.20 (0.079 ± 0.008) | 3.20 ± 0.20 (0.126 ± 0.008) | |
| (W) Width | mm 0.20 ± 0.02 (0.008 ± 0.0008) | 0.30 ± 0.09 (0.011 ± 0.004) | 0.50 ± 0.10 (0.020 ± 0.004) | 0.81 ± 0.15 (0.032 ± 0.006) | 1.25 ± 0.20 (0.049 ± 0.008) | 1.60 ± 0.20 (0.063 ± 0.008) | |
| (t) Terminal | mm 0.10 ± 0.04 (0.004 ± 0.0016) | 0.15 ± 0.05 (0.006 ± 0.002) | 0.25 ± 0.15 (0.010 ± 0.006) | 0.35 ± 0.15 (0.014 ± 0.006) | 0.50 ± 0.25 (0.020 ± 0.010) | 0.50 ± 0.25 (0.020 ± 0.010) | |
| WVDC | 16 | 25 50 | 16 25 50 | 16 25 50 100 200 | 16 25 50 100 200 250 | 16 25 50 100 200 250 500 | |
| Cap (pF) | 0.5 1.0 1.2 1.5 | A A A A | A A A A | C C C C | C G G G | G G G G | J J J J |
| | 1.8 2.2 2.7 | A A A | A A A | C C C | C G G | G G G | J J J |
| | 3.3 3.9 4.7 | A A A | A A A | C C C | C G G | G G G | J J J |
| | 5.6 6.8 8.2 | A A A | A A A | C C C | C G G | G G G | J J J |
| | 10 12 15 | A A A | A A A | C C C | C G G | G G G | J J J |
| | 18 22 27 | A A A | A A A | C C C | C G G | G G G | J J J |
| | 33 39 47 | A A A | A A A | C C C | C G G | G G G | J J J |
| | 56 68 82 | A A A | A A A | C C C | C G G | G G G | J J J |
| | 100 120 150 | A A A | A A A | C C C | C G G | G G G | J J J |
| | 180 220 270 | | | C C C | C G G | G G G | J J J |
| | 330 390 470 | | | C C C | C G G | G G G | J J J |
| | 560 680 750 820 | | | C C C | C G G | G G G | J J J |
| | 1000 1200 1500 | | | C C C | C G G | G G G | J J J |
| | 1800 2200 2700 | | | | G G G | G G G | J J J |
| | 3300 3900 4700 | | | | G G G | G G G | J J J |
| | 5600 6800 8200 | | | | | G G G | J J J |
| Cap (µF) | 0.010 0.012 0.015 | | | | | | J J J |
| | 0.018 0.022 0.027 | | | | | | J J J |
| | 0.033 0.039 0.047 | | | | | | J J J |
| | 0.068 0.082 0.1 | | | | | | J J J |
| WVDC | 16 | 25 50 | 16 25 50 | 16 25 50 100 200 | 16 25 50 100 200 250 | 16 25 50 100 200 250 500 | |
| SIZE | 0101* | 0201 | 0402 | 0603 | 0805 | 1206 | |

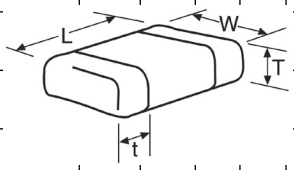

| Letter | A | B | C | E | G | J | K | M | N | P | Q | X | Y | Z |
|----------------|-----------------|-----------------|-----------------|-----------------|-----------------|-----------------|-----------------|-----------------|-----------------|-----------------|-----------------|-----------------|-----------------|-----------------|
| Max. Thickness | 0.33 (0.013) | 0.22 (0.009) | 0.56 (0.022) | 0.71 (0.028) | 0.90 (0.035) | 0.94 (0.037) | 1.02 (0.040) | 1.27 (0.050) | 1.40 (0.055) | 1.52 (0.060) | 1.78 (0.070) | 2.29 (0.090) | 2.54 (0.100) | 2.79 (0.110) |
| | PAPER | | | | | | EMBOSS | | | | | | | |



The Important Information/Disclaimer is incorporated in the catalog where these specifications came from or available online at www.avx.com/disclaimer/ by reference and should be reviewed in full before placing any order.

C0G (NP0) Dielectric Capacitance Range



PREFERRED SIZES ARE SHADED



| SIZE | 1210 | | | | | 1812 | | | | | 1825 | | | 2220 | | | 2225 | | |
|--------------|--------------------------------|----|-----|-----|-----|--------------------------------|----|-----|-----|-----|--------------------------------|-----|-----|--------------------------------|-----|-----|--------------------------------|-----|-----|
| Soldering | Reflow Only | | | | | Reflow Only | | | | | Reflow Only | | | Reflow Only | | | Reflow Only | | |
| Packaging | Paper/Embossed | | | | | All Embossed | | | | | All Embossed | | | All Embossed | | | All Embossed | | |
| (L) Length | 3.20 ± 0.20 (0.126 ± 0.008) | | | | | 4.50 ± 0.30 (0.177 ± 0.012) | | | | | 4.50 ± 0.30 (0.177 ± 0.012) | | | 5.70 ± 0.40 (0.225 ± 0.016) | | | 5.72 ± 0.25 (0.225 ± 0.010) | | |
| (W) Width | 2.50 ± 0.20 (0.098 ± 0.008) | | | | | 3.20 ± 0.20 (0.126 ± 0.008) | | | | | 6.40 ± 0.40 (0.252 ± 0.016) | | | 5.00 ± 0.40 (0.197 ± 0.016) | | | 6.35 ± 0.25 (0.250 ± 0.010) | | |
| (t) Terminal | 0.50 ± 0.25 (0.020 ± 0.010) | | | | | 0.61 ± 0.36 (0.024 ± 0.014) | | | | | 0.61 ± 0.36 (0.024 ± 0.014) | | | 0.64 ± 0.39 (0.025 ± 0.015) | | | 0.64 ± 0.39 (0.025 ± 0.015) | | |
| WVDC | 25 | 50 | 100 | 200 | 500 | 25 | 50 | 100 | 200 | 500 | 50 | 100 | 200 | 50 | 100 | 200 | 50 | 100 | 200 |
| Cap (pF) | 3.9 | | | | | | | | | | | | | | | | | | |
| | 4.7 | | | | | | | | | | | | | | | | | | |
| | 5.6 | | | | | | | | | | | | | | | | | | |
| | 6.8 | | | | | | | | | | | | | | | | | | |
| | 8.2 | | | | | | | | | | | | | | | | | | |
| | 10 | M | M | M | M | M | P | P | P | P | | | | | | | | | |
| | 12 | M | M | M | M | M | P | P | P | P | | | | | | | | | |
| | 15 | M | M | M | M | M | P | P | P | P | | | | | | | | | |
| | 18 | M | M | M | M | M | P | P | P | P | | | | | | | | | |
| | 22 | M | M | M | M | M | P | P | P | P | | | | | | | | | |
| | 27 | M | M | M | M | M | P | P | P | P | | | | | | | | | |
| | 33 | M | M | M | M | M | P | P | P | P | | | | | | | | | |
| | 39 | M | M | M | M | M | P | P | P | P | | | | | | | | | |
| | 47 | P | P | P | P | P | P | P | P | P | | | | | | | | | |
| | 56 | P | P | P | P | P | P | P | P | P | | | | | | | | | |
| | 68 | P | P | P | P | P | P | P | P | P | | | | | | | | | |
| | 82 | P | P | P | P | P | P | P | P | P | | | | | | | | | |
| | 100 | P | P | P | P | P | P | P | P | P | | | | | | | | | |
| | 120 | P | P | P | P | P | P | P | P | P | | | | | | | | | |
| | 150 | P | P | P | P | P | P | P | P | P | | | | | | | | | |
| | 180 | P | P | P | P | P | P | P | P | P | | | | | | | | | |
| | 220 | P | P | P | P | P | P | P | P | P | | | | | | | | | |
| | 270 | P | P | P | P | P | P | P | P | P | | | | | | | | | |
| | 330 | P | P | P | P | P | P | P | P | P | | | | | | | | | |
| | 390 | P | P | P | P | P | P | P | P | P | | | | | | | | | |
| | 470 | P | P | P | P | P | P | P | P | P | | | | | | | | | |
| | 560 | P | P | P | P | P | P | P | P | P | | | | | | | | | |
| | 680 | P | P | P | P | P | P | P | P | P | | | | | | | | | |
| | 820 | P | P | P | P | P | P | P | P | P | | | | | | | | | |
| | 1000 | P | P | P | P | P | P | P | P | P | M | M | M | | | | M | M | P |
| | 1200 | P | P | P | P | P | P | P | P | P | M | M | M | | | | M | M | P |
| | 1500 | P | P | P | P | P | P | P | P | P | M | M | M | | | | M | M | P |
| | 1800 | P | P | P | P | P | P | P | P | P | M | M | M | | | | M | M | P |
| | 2200 | P | P | P | P | P | P | P | P | P | X | X | M | | | | M | M | P |
| | 2700 | P | P | P | P | P | P | P | P | Q | X | X | M | | | | M | M | P |
| | 3300 | P | P | P | P | P | P | P | P | Q | X | X | X | | | X | M | M | P |
| | 3900 | P | P | P | P | P | P | P | P | Q | X | X | X | | | X | M | M | P |
| | 4700 | P | P | P | P | P | P | P | P | Y | X | X | X | | X | X | M | M | P |
| | 5600 | P | P | P | P | P | P | P | P | Y | X | X | X | | X | X | M | M | P |
| | 6800 | P | P | P | X | X | P | P | Q | Q | Y | X | X | | X | X | M | M | P |
| | 8200 | P | P | P | X | X | P | P | Q | Q | Y | X | X | | X | X | M | M | P |
| Cap (pF) | 0.010 | P | P | X | X | X | P | P | Q | Q | Y | X | X | | X | X | M | M | P |
| | 0.012 | X | X | X | X | X | P | P | Q | X | Y | X | X | | X | X | M | M | P |
| | 0.015 | X | X | X | Z | Z | P | P | Q | X | Y | X | X | | X | X | M | M | Y |
| | 0.018 | X | X | Z | Z | | P | P | X | X | Y | X | X | | X | X | M | M | Y |
| | 0.022 | X | X | Z | Z | | P | P | X | X | | X | X | | X | X | M | Y | Y |
| | 0.027 | X | Z | Z | Z | | Q | X | X | Z | | X | X | | X | X | P | Y | Y |
| | 0.033 | X | Z | Z | Z | | Q | X | X | Z | | X | X | | X | X | X | Y | Y |
| | 0.039 | Z | Z | Z | | | X | X | Z | Z | | X | | | Y | | X | Y | Y |
| | 0.047 | Z | Z | Z | | | X | X | Z | Z | | X | | | Y | | X | Z | |
| | 0.068 | | | | | | Z | Z | Z | | | | | | Z | | X | Z | |
| | 0.082 | | | | | | Z | Z | Z | | | | | | Z | | X | Z | |
| | 0.1 | | | | | | Z | Z | Z | | | | | | Z | | Z | Z | |
| WVDC | 25 | 50 | 100 | 200 | 500 | 25 | 50 | 100 | 200 | 500 | 50 | 100 | 200 | 50 | 100 | 200 | 50 | 100 | 200 |
| SIZE | 1210 | | | | | 1812 | | | | | 1825 | | | 2220 | | | 2225 | | |

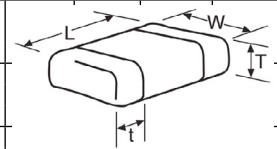

| Letter | A | B | C | E | G | J | K | M | N | P | Q | X | Y | Z |
|----------------|-----------------|-----------------|-----------------|-----------------|-----------------|-----------------|-----------------|-----------------|-----------------|-----------------|-----------------|-----------------|-----------------|-----------------|
| Max. Thickness | 0.33 (0.013) | 0.22 (0.009) | 0.56 (0.022) | 0.71 (0.028) | 0.90 (0.035) | 0.94 (0.037) | 1.02 (0.040) | 1.27 (0.050) | 1.40 (0.055) | 1.52 (0.060) | 1.78 (0.070) | 2.29 (0.090) | 2.54 (0.100) | 2.79 (0.110) |
| | PAPER | | | | | | EMBOSSSED | | | | | | | |

U Dielectric RF/Microwave C0G (NP0) Capacitors (RoHS)



Ultra Low ESR, "U" Series, C0G (NP0) Chip Capacitors

GENERAL INFORMATION

"U" Series capacitors are C0G (NP0) chip capacitors specially designed for "Ultra" low ESR for applications in the communications market. Max ESR and effective capacitance are met on each value producing lot to lot uniformity. Sizes available are EIA chip sizes 0603, 0805, and 1210.

DIMENSIONS: inches (millimeters)

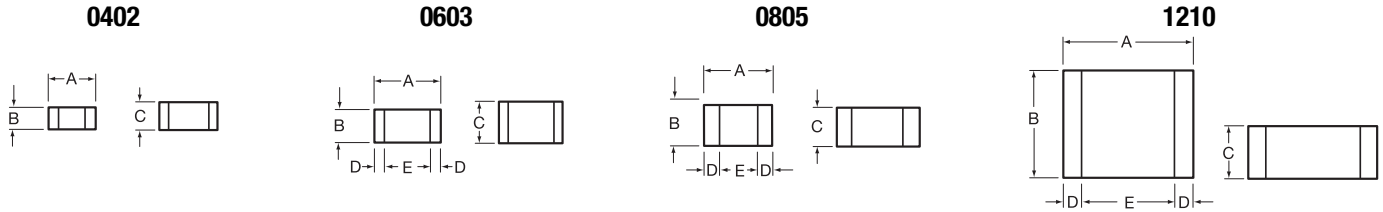

| Size | A | B | C | D | E |
|------|-------------------------|-------------------------|--------------------|-------------------------------|------------------|
| 0402 | 0.039±0.004 (1.00±0.1) | 0.020±0.004 (0.50±0.1) | 0.024 (0.6) max | 0.010 ± 0.006 (0.25 ± 0.15) | 0.014 (0.36) min |
| 0603 | 0.060±0.010 (1.52±0.25) | 0.030±0.010 (0.76±0.25) | 0.036 (0.91) max | 0.010 ± 0.005 (0.25 ± 0.13) | 0.030 (0.76) min |
| 0805 | 0.079±0.008 (2.01±0.2) | 0.049±0.008 (1.25±0.2) | 0.045 (1.15mm) max | 0.020 ± 0.010 (0.51 ± 0.254) | 0.020 (0.51) min |
| 1210 | 0.126±0.008 (3.2±0.2) | 0.098±0.008 (2.49±0.2) | 0.055 (1.40mm) max | 0.025 ± 0.015 (0.635 ± 0.381) | 0.040 (1.02) min |

HOW TO ORDER

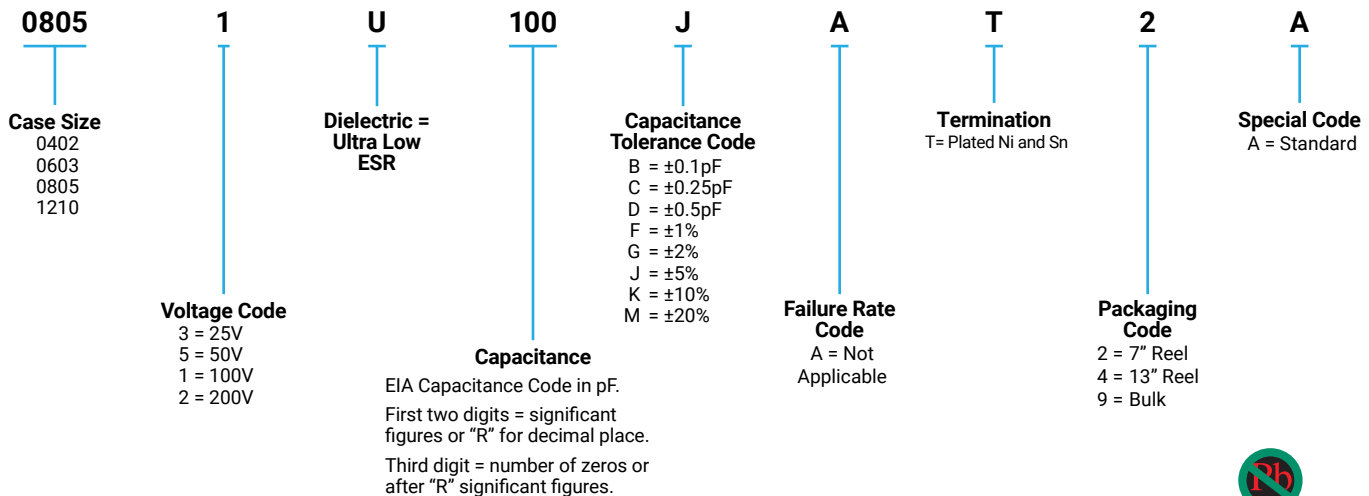

ELECTRICAL CHARACTERISTICS

Capacitance Values and Tolerances:

- Size 0402 - 0.2 pF to 22 pF @ 1 MHz
- Size 0603 - 1.0 pF to 100 pF @ 1 MHz
- Size 0805 - 1.6 pF to 160 pF @ 1 MHz
- Size 1210 - 2.4 pF to 1000 pF @ 1 MHz

Temperature Coefficient of Capacitance (TC):

0±30 ppm/°C (-55° to +125°C)

Insulation Resistance (IR):

- 10¹² Ω min. @ 25°C and rated WVDC
- 10¹¹ Ω min. @ 125°C and rated WVDC

Working Voltage (WVDC):

- | | |
|------|---------------------|
| Size | Working Voltage |
| 0402 | - 50, 25 WVDC |
| 0603 | - 200, 100, 50 WVDC |
| 0805 | - 200, 100 WVDC |
| 1210 | - 200, 100 WVDC |

Dielectric Working Voltage (DWV):

250% of rated WVDC

Equivalent Series Resistance Typical (ESR):

- 0402 - See Performance Curve, page 300
- 0603 - See Performance Curve, page 300
- 0805 - See Performance Curve, page 300
- 1210 - See Performance Curve, page 300

Marking

Laser marking EIA J marking standard (except 0603) (capacitance code and tolerance upon request).

MILITARY SPECIFICATIONS

Meets or exceeds the requirements of MIL-C-55681



The Important Information/Disclaimer is incorporated in the catalog where these specifications came from or available online at www.avx.com/disclaimer/ by reference and should be reviewed in full before placing any order.

U Dielectric RF/Microwave COG (NP0) Capacitors (RoHS)



Ultra Low ESR, "U" Series, COG (NP0) Chip Capacitors

CAPACITANCE RANGE

| Cap (pF) | Available Tolerance | Size | | | | Cap (pF) | Available Tolerance | Size | | | | Cap (pF) | Available Tolerance | Size | | | |
|----------|---------------------|------|------|------|------|----------|---------------------|------|------|------|------|----------|---------------------|------|------|------|------|
| | | 0402 | 0603 | 0805 | 1210 | | | 0402 | 0603 | 0805 | 1210 | | | 0402 | 0603 | 0805 | 1210 |
| 0.2 | B,C | 50V | N/A | N/A | N/A | 1.0 | B,C,D | 50V | 200V | 200V | 200V | 100 | FG,J,K,M | N/A | 100V | 200V | 200V |
| 0.3 | ↓ | ↓ | ↓ | ↓ | ↓ | 1.1 | ↓ | ↓ | ↓ | ↓ | ↓ | 110 | ↓ | ↓ | ↓ | ↓ | ↓ |
| 0.4 | B,C | ↓ | ↓ | ↓ | ↓ | 1.2 | ↓ | ↓ | ↓ | ↓ | ↓ | 120 | ↓ | ↓ | ↓ | ↓ | ↓ |
| 0.5 | B,C | ↓ | ↓ | ↓ | ↓ | 1.3 | ↓ | ↓ | ↓ | ↓ | ↓ | 130 | ↓ | ↓ | ↓ | ↓ | ↓ |
| 0.6 | B,C,D | ↓ | ↓ | ↓ | ↓ | 1.4 | ↓ | ↓ | ↓ | ↓ | ↓ | 140 | ↓ | ↓ | ↓ | ↓ | ↓ |
| 0.7 | B,C,D | ↓ | ↓ | ↓ | ↓ | 1.5 | ↓ | ↓ | ↓ | ↓ | ↓ | 150 | ↓ | ↓ | ↓ | ↓ | ↓ |
| 0.8 | ↓ | ↓ | ↓ | ↓ | ↓ | 1.6 | ↓ | ↓ | ↓ | ↓ | ↓ | 160 | ↓ | ↓ | ↓ | ↓ | ↓ |
| 0.9 | B,C,D | ↓ | ↓ | ↓ | ↓ | 1.7 | ↓ | ↓ | ↓ | ↓ | ↓ | 180 | ↓ | ↓ | ↓ | ↓ | ↓ |
| | | | | | | 1.8 | ↓ | ↓ | ↓ | ↓ | ↓ | 200 | ↓ | ↓ | ↓ | ↓ | ↓ |
| | | | | | | 1.9 | ↓ | ↓ | ↓ | ↓ | ↓ | 220 | ↓ | ↓ | ↓ | ↓ | ↓ |
| | | | | | | 2.0 | ↓ | ↓ | ↓ | ↓ | ↓ | 270 | ↓ | ↓ | ↓ | ↓ | ↓ |
| | | | | | | 2.1 | ↓ | ↓ | ↓ | ↓ | ↓ | 300 | ↓ | ↓ | ↓ | ↓ | ↓ |
| | | | | | | 2.2 | ↓ | ↓ | ↓ | ↓ | ↓ | 330 | ↓ | ↓ | ↓ | ↓ | ↓ |
| | | | | | | 2.4 | ↓ | ↓ | ↓ | ↓ | ↓ | 360 | ↓ | ↓ | ↓ | ↓ | ↓ |
| | | | | | | 2.7 | ↓ | ↓ | ↓ | ↓ | ↓ | 390 | ↓ | ↓ | ↓ | ↓ | ↓ |
| | | | | | | 3.0 | ↓ | ↓ | ↓ | ↓ | ↓ | 430 | ↓ | ↓ | ↓ | ↓ | ↓ |
| | | | | | | 3.3 | ↓ | ↓ | ↓ | ↓ | ↓ | 470 | ↓ | ↓ | ↓ | ↓ | ↓ |
| | | | | | | 3.6 | ↓ | ↓ | ↓ | ↓ | ↓ | 510 | ↓ | ↓ | ↓ | ↓ | ↓ |
| | | | | | | 3.9 | ↓ | ↓ | ↓ | ↓ | ↓ | 560 | ↓ | ↓ | ↓ | ↓ | ↓ |
| | | | | | | 4.3 | ↓ | ↓ | ↓ | ↓ | ↓ | 620 | ↓ | ↓ | ↓ | ↓ | ↓ |
| | | | | | | 4.7 | ↓ | ↓ | ↓ | ↓ | ↓ | 680 | ↓ | ↓ | ↓ | ↓ | ↓ |
| | | | | | | 5.1 | ↓ | ↓ | ↓ | ↓ | ↓ | 750 | ↓ | ↓ | ↓ | ↓ | ↓ |
| | | | | | | 5.6 | ↓ | ↓ | ↓ | ↓ | ↓ | 820 | ↓ | ↓ | ↓ | ↓ | ↓ |
| | | | | | | 6.2 | B,C,D | ↓ | ↓ | ↓ | ↓ | 910 | ↓ | ↓ | ↓ | ↓ | ↓ |
| | | | | | | 6.8 | B,C,J,K,M | ↓ | ↓ | ↓ | ↓ | 1000 | FG,J,K,M | ↓ | ↓ | ↓ | ↓ |

ULTRA LOW ESR, "U" SERIES

TYPICAL ESR vs. FREQUENCY
0402 "U" SERIES

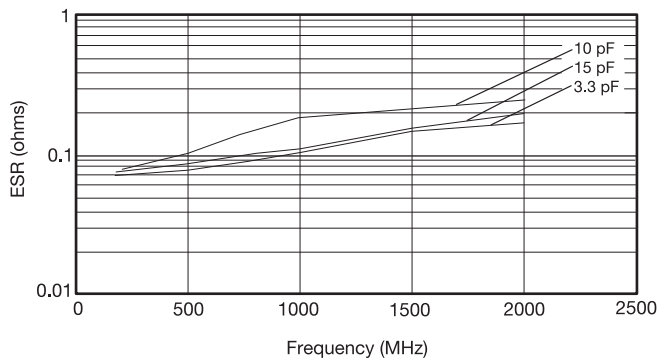

TYPICAL ESR vs. FREQUENCY
0603 "U" SERIES

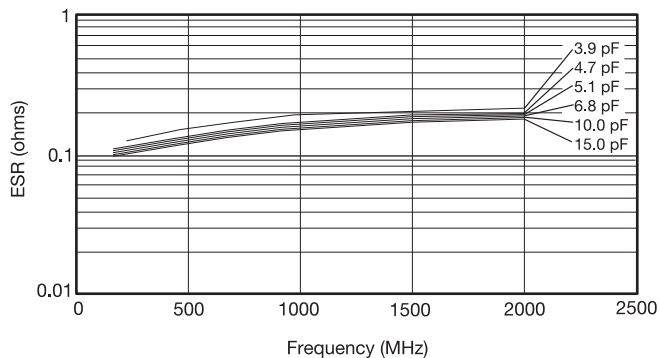

TYPICAL ESR vs. FREQUENCY
0805 "U" SERIES

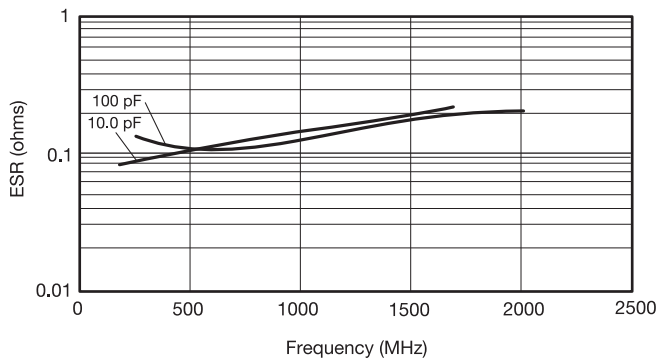

TYPICAL ESR vs. FREQUENCY
1210 "U" SERIES

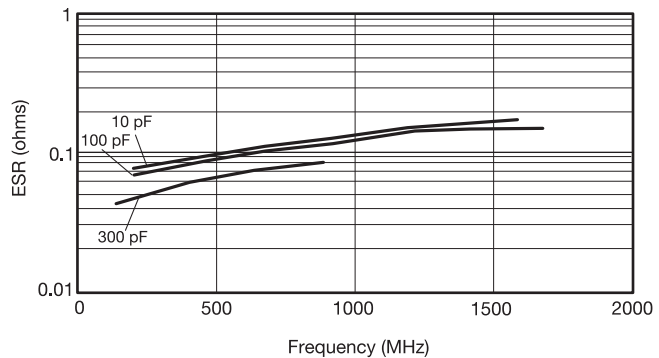

ESR Measured on the Boonton 34A

U Dielectric
RF/Microwave C0G (NP0) Capacitors
Ultra Low ESR, "U" Series, C0G (NP0) Chip Capacitors



**TYPICAL
SERIES RESONANT FREQUENCY
"U" SERIES CHIP**

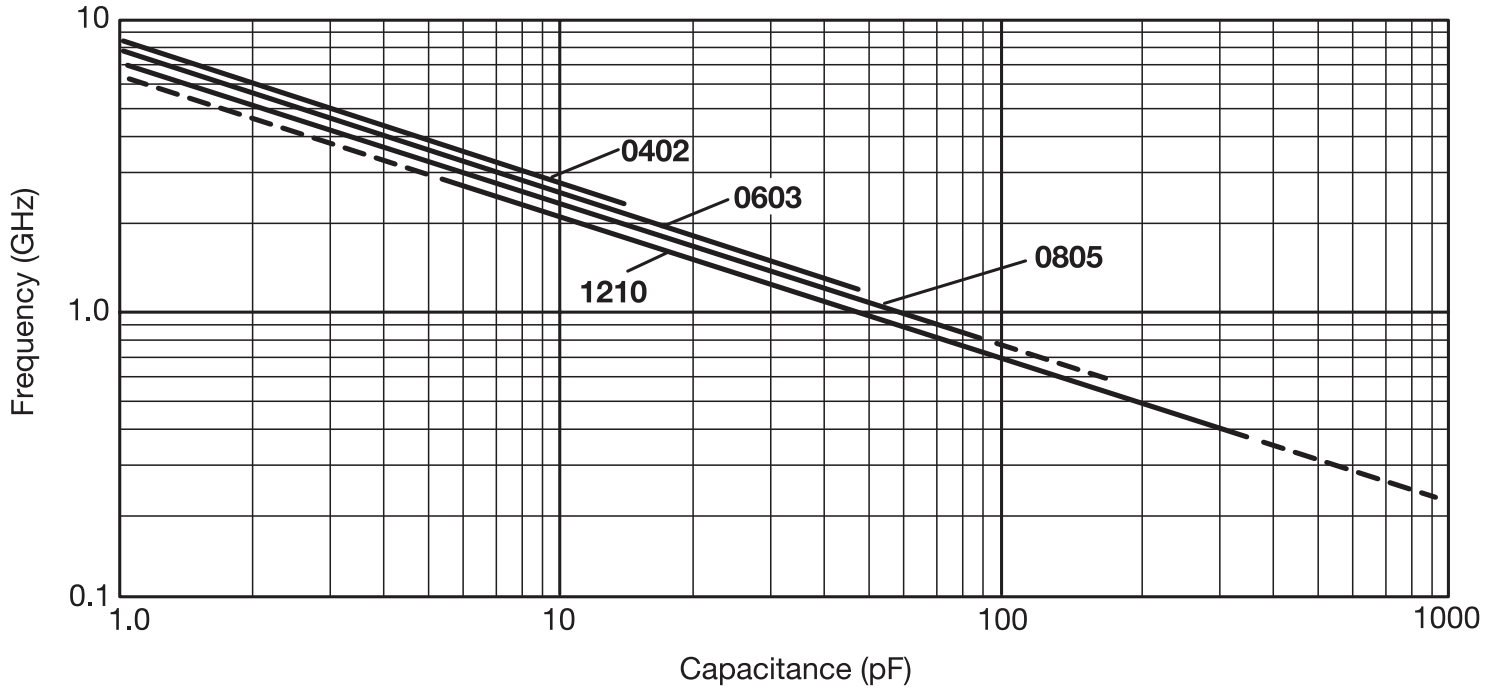

U Dielectric RF/Microwave C0G (NP0) Capacitors (Sn/Pb)



Ultra Low ESR, "U" Series, C0G (NP0) Chip Capacitors

GENERAL INFORMATION

"U" Series capacitors are C0G (NP0) chip capacitors specially designed for "Ultra" low ESR for applications in the communications market. Max ESR and effective capacitance are met on each value producing lot to lot uniformity. Sizes available are EIA chip sizes 0603, 0805, and 1210.

DIMENSIONS: inches (millimeters)

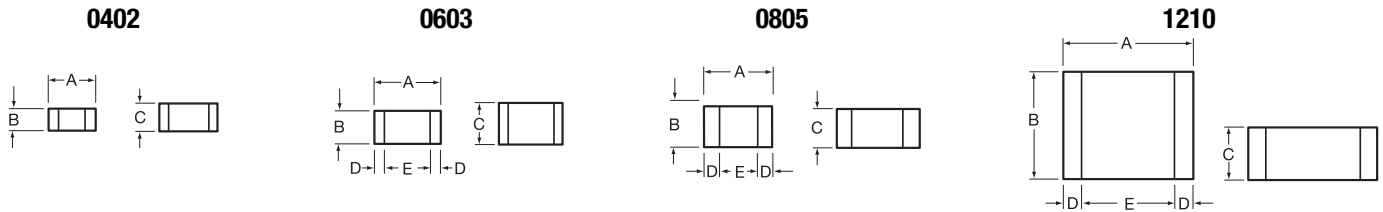

| Size | A | B | C | D | E |
|------|-------------------------|-------------------------|--------------------|-----------------------------|------------------|
| 0402 | 0.039±0.004 (1.00±0.1) | 0.020±0.004 (0.50±0.1) | 0.024 (0.6) max | 0.010 ± 0.006 (0.25 ± 0.15) | 0.014 (0.36) min |
| 0603 | 0.060±0.010 (1.52±0.25) | 0.030±0.010 (0.76±0.25) | 0.036 (0.91) max | 0.010±0.005 (0.25±0.13) | 0.030 (0.76) min |
| 0805 | 0.079±0.008 (2.01±0.2) | 0.049±0.008 (1.25±0.2) | 0.045 (1.15mm) max | 0.020±0.010 (0.51±0.254) | 0.020 (0.51) min |
| 1210 | 0.126±0.008 (3.2±0.2) | 0.098±0.008 (2.49±0.2) | 0.055 (1.40mm) max | 0.025±0.015 (0.635±0.381) | 0.040 (1.02) min |

HOW TO ORDER

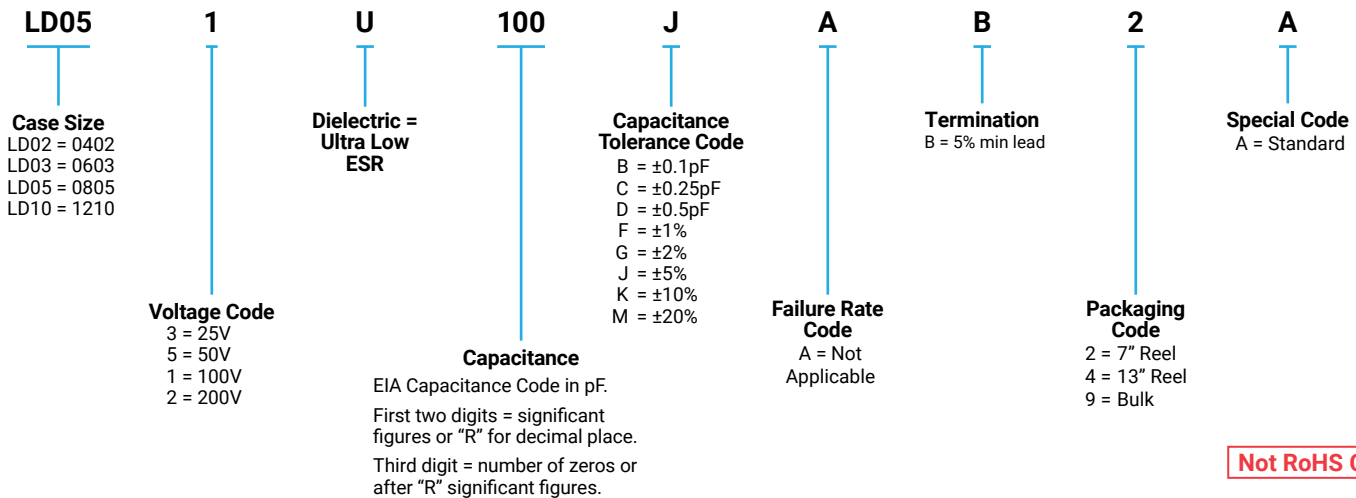

Not RoHS Compliant

ELECTRICAL CHARACTERISTICS

Capacitance Values and Tolerances:

- Size 0402 - 0.2 pF to 22 pF @ 1 MHz
- Size 0603 - 1.0 pF to 100 pF @ 1 MHz
- Size 0805 - 1.6 pF to 160 pF @ 1 MHz
- Size 1210 - 2.4 pF to 1000 pF @ 1 MHz

Temperature Coefficient of Capacitance (TC):

0±30 ppm/°C (-55° to +125°C)

Insulation Resistance (IR):

- 10¹² Ω min. @ 25°C and rated WVDC
- 10¹¹ Ω min. @ 125°C and rated WVDC

Working Voltage (WVDC):

- | | |
|------|---------------------|
| Size | Working Voltage |
| 0402 | - 50, 25 WVDC |
| 0603 | - 200, 100, 50 WVDC |
| 0805 | - 200, 100 WVDC |
| 1210 | - 200, 100 WVDC |

Dielectric Working Voltage (DWV):

250% of rated WVDC

Equivalent Series Resistance Typical (ESR):

- 040 - See Performance Curve, page 306
- 0603 - See Performance Curve, page 306
- 0805 - See Performance Curve, page 306
- 1210 - See Performance Curve, page 306

Marking:

Laser marking EIA J marking standard (except 0603) (capacitance code and tolerance upon request).

Military Specifications

Meets or exceeds the requirements of MIL-C-55681

U Dielectric RF/Microwave C0G (NP0) Capacitors (Sn/Pb)



Ultra Low ESR, "U" Series, C0G (NP0) Chip Capacitors

CAPACITANCE RANGE

| Cap (pF) | Available Tolerance | Size | | | |
|----------|---------------------|------|------|------|------|
| | | LD02 | LD03 | LD05 | LD10 |
| 0.2 | B,C | 50V | N/A | N/A | N/A |
| 0.3 | ↓ | ↓ | ↓ | ↓ | ↓ |
| 0.4 | ↓ | ↓ | ↓ | ↓ | ↓ |
| 0.5 | B,C | ↓ | ↓ | ↓ | ↓ |
| 0.6 | B,C,D | ↓ | ↓ | ↓ | ↓ |
| 0.7 | ↓ | ↓ | ↓ | ↓ | ↓ |
| 0.8 | ↓ | ↓ | ↓ | ↓ | ↓ |
| 0.9 | B,C,D | ↓ | ↓ | ↓ | ↓ |

| Cap (pF) | Available Tolerance | Size | | | |
|----------|---------------------|------|------|------|------|
| | | LD02 | LD03 | LD05 | LD10 |
| 1.0 | B,C,D | 50V | 200V | 200V | 200V |
| 1.1 | ↓ | ↓ | ↓ | ↓ | ↓ |
| 1.2 | ↓ | ↓ | ↓ | ↓ | ↓ |
| 1.3 | ↓ | ↓ | ↓ | ↓ | ↓ |
| 1.4 | ↓ | ↓ | ↓ | ↓ | ↓ |
| 1.5 | ↓ | ↓ | ↓ | ↓ | ↓ |
| 1.6 | ↓ | ↓ | ↓ | ↓ | ↓ |
| 1.7 | ↓ | ↓ | ↓ | ↓ | ↓ |
| 1.8 | ↓ | ↓ | ↓ | ↓ | ↓ |
| 1.9 | ↓ | ↓ | ↓ | ↓ | ↓ |
| 2.0 | ↓ | ↓ | ↓ | ↓ | ↓ |
| 2.1 | ↓ | ↓ | ↓ | ↓ | ↓ |
| 2.2 | ↓ | ↓ | ↓ | ↓ | ↓ |
| 2.4 | ↓ | ↓ | ↓ | ↓ | ↓ |
| 2.7 | ↓ | ↓ | ↓ | ↓ | ↓ |
| 3.0 | ↓ | ↓ | ↓ | ↓ | ↓ |
| 3.3 | ↓ | ↓ | ↓ | ↓ | ↓ |
| 3.6 | ↓ | ↓ | ↓ | ↓ | ↓ |
| 3.9 | ↓ | ↓ | ↓ | ↓ | ↓ |
| 4.3 | ↓ | ↓ | ↓ | ↓ | ↓ |
| 4.7 | ↓ | ↓ | ↓ | ↓ | ↓ |
| 5.1 | ↓ | ↓ | ↓ | ↓ | ↓ |
| 5.6 | ↓ | ↓ | ↓ | ↓ | ↓ |
| 6.2 | ↓ | ↓ | ↓ | ↓ | ↓ |
| 6.8 | B,C,D B,C,J,K,M | ↓ | ↓ | ↓ | ↓ |

| Cap (pF) | Available Tolerance | Size | | | |
|----------|---------------------|------|------|------|------|
| | | LD02 | LD03 | LD05 | LD10 |
| 7.5 | B,C,J,K,M | 50V | 200V | 200V | 200V |
| 8.2 | ↓ | ↓ | ↓ | ↓ | ↓ |
| 9.1 | B,C,J,K,M | ↓ | ↓ | ↓ | ↓ |
| 10 | F,G,J,K,M | ↓ | ↓ | ↓ | ↓ |
| 11 | ↓ | ↓ | ↓ | ↓ | ↓ |
| 12 | ↓ | ↓ | ↓ | ↓ | ↓ |
| 13 | ↓ | ↓ | ↓ | ↓ | ↓ |
| 15 | ↓ | ↓ | ↓ | ↓ | ↓ |
| 18 | ↓ | ↓ | ↓ | ↓ | ↓ |
| 20 | ↓ | ↓ | ↓ | ↓ | ↓ |
| 22 | ↓ | ↓ | ↓ | ↓ | ↓ |
| 24 | ↓ | ↓ | ↓ | ↓ | ↓ |
| 27 | ↓ | ↓ | ↓ | ↓ | ↓ |
| 30 | ↓ | ↓ | ↓ | ↓ | ↓ |
| 33 | ↓ | ↓ | ↓ | ↓ | ↓ |
| 36 | ↓ | ↓ | ↓ | ↓ | ↓ |
| 39 | ↓ | ↓ | ↓ | ↓ | ↓ |
| 43 | ↓ | ↓ | ↓ | ↓ | ↓ |
| 47 | ↓ | ↓ | ↓ | ↓ | ↓ |
| 51 | ↓ | ↓ | ↓ | ↓ | ↓ |
| 56 | ↓ | ↓ | ↓ | ↓ | ↓ |
| 68 | ↓ | ↓ | ↓ | ↓ | ↓ |
| 75 | ↓ | ↓ | ↓ | ↓ | ↓ |
| 82 | ↓ | ↓ | ↓ | ↓ | ↓ |
| 91 | ↓ | ↓ | ↓ | ↓ | ↓ |

| Cap (pF) | Available Tolerance | Size | | | |
|----------|---------------------|------|------|------|------|
| | | LD02 | LD03 | LD05 | LD10 |
| 100 | F,G,J,K,M | N/A | 100V | 200V | 200V |
| 110 | ↓ | ↓ | ↓ | ↓ | ↓ |
| 120 | ↓ | ↓ | ↓ | ↓ | ↓ |
| 130 | ↓ | ↓ | ↓ | ↓ | ↓ |
| 140 | ↓ | ↓ | ↓ | ↓ | ↓ |
| 150 | ↓ | ↓ | ↓ | ↓ | ↓ |
| 160 | ↓ | ↓ | ↓ | ↓ | ↓ |
| 180 | ↓ | ↓ | ↓ | ↓ | ↓ |
| 200 | ↓ | ↓ | ↓ | ↓ | ↓ |
| 220 | ↓ | ↓ | ↓ | ↓ | ↓ |
| 270 | ↓ | ↓ | ↓ | ↓ | ↓ |
| 300 | ↓ | ↓ | ↓ | ↓ | ↓ |
| 330 | ↓ | ↓ | ↓ | ↓ | ↓ |
| 360 | ↓ | ↓ | ↓ | ↓ | ↓ |
| 390 | ↓ | ↓ | ↓ | ↓ | ↓ |
| 430 | ↓ | ↓ | ↓ | ↓ | ↓ |
| 470 | ↓ | ↓ | ↓ | ↓ | ↓ |
| 510 | ↓ | ↓ | ↓ | ↓ | ↓ |
| 560 | ↓ | ↓ | ↓ | ↓ | ↓ |
| 620 | ↓ | ↓ | ↓ | ↓ | ↓ |
| 680 | ↓ | ↓ | ↓ | ↓ | ↓ |
| 750 | ↓ | ↓ | ↓ | ↓ | ↓ |
| 820 | ↓ | ↓ | ↓ | ↓ | ↓ |
| 910 | ↓ | ↓ | ↓ | ↓ | ↓ |
| 1000 | F,G,J,K,M | ↓ | ↓ | ↓ | ↓ |

ULTRA LOW ESR, "U" SERIES

TYPICAL ESR vs. FREQUENCY
0402 "U" SERIES

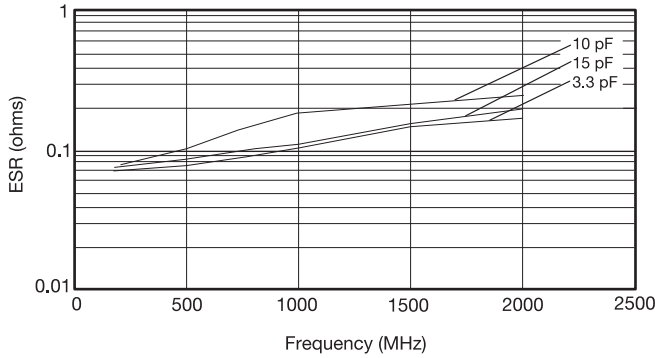

TYPICAL ESR vs. FREQUENCY
0603 "U" SERIES

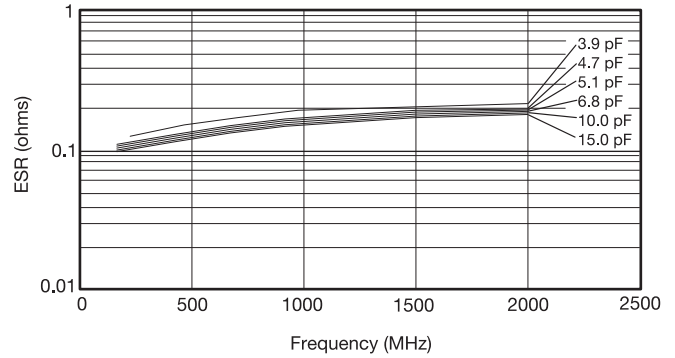

TYPICAL ESR vs. FREQUENCY
0805 "U" SERIES

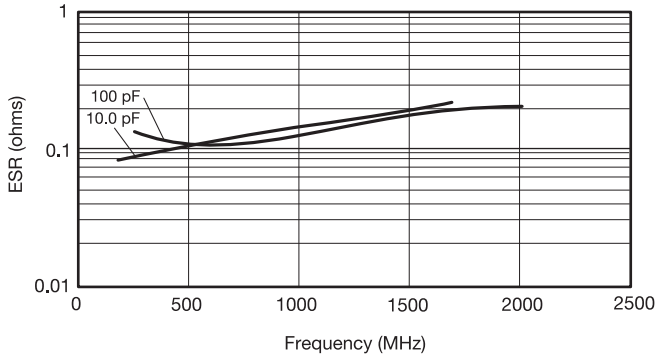

TYPICAL ESR vs. FREQUENCY
1210 "U" SERIES

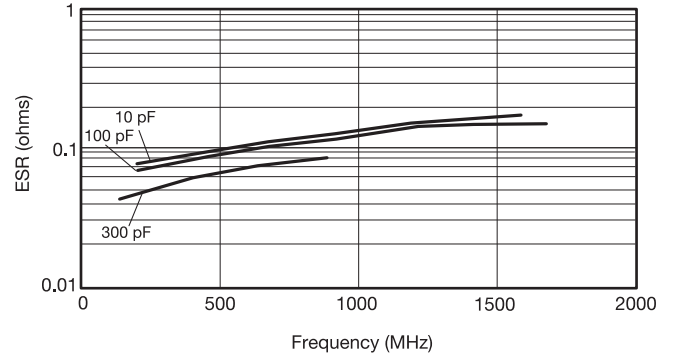

ESR Measured on the Boonton 34A

RF/Microwave Capacitors

RF/Microwave C0G (NP0) Capacitors

Ultra Low ESR "U" Series, C0G (NP0) Capacitors (Sn/Pb)



TYPICAL
SERIES RESONANT FREQUENCY
"U" SERIES CHIP

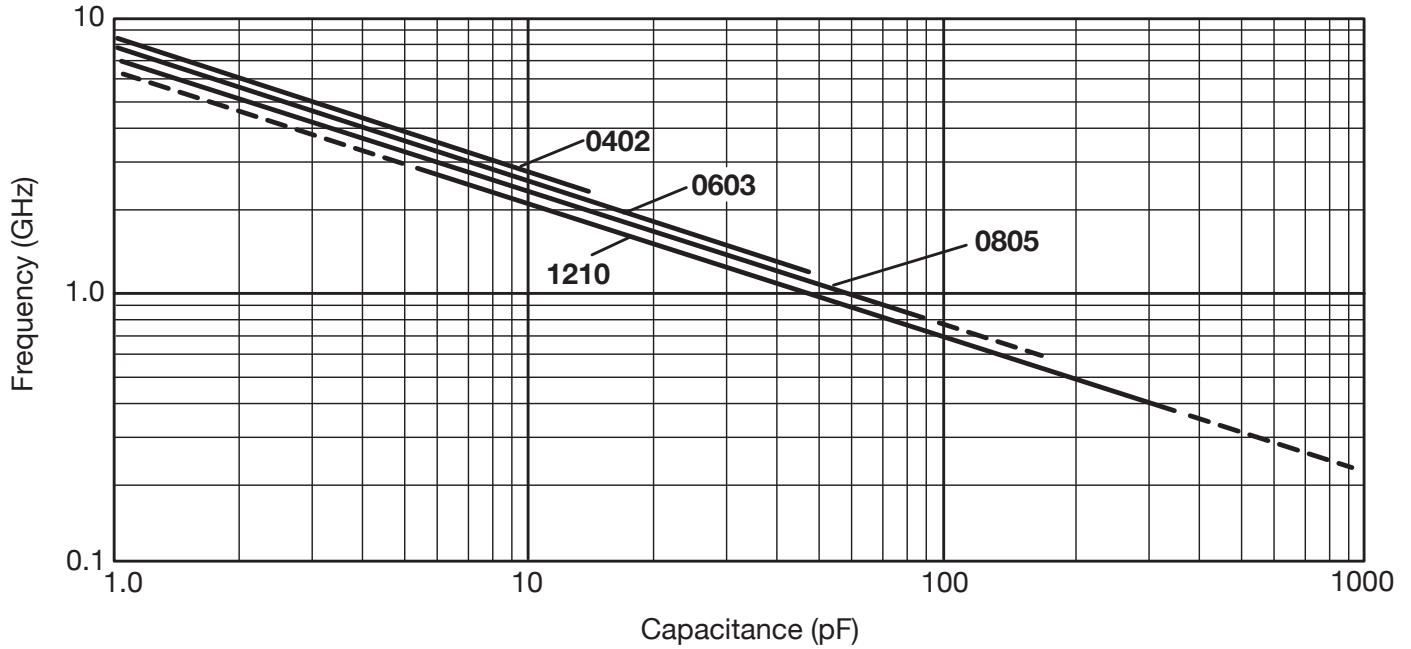

U Dielectric

RF/Microwave Automotive C0G (NP0) Capacitors (RoHS)

AEC Q200 Qualified Ultra Low ESR, "U" Series, C0G (NP0) Chip Capacitors



GENERAL INFORMATION

Automotive "U" Series capacitors are C0G (NP0) chip capacitors specially designed for "Ultra" low ESR for applications in the automotive market. Max ESR and effective capacitance are met on each value producing lot to lot uniformity. Sizes available are EIA chip sizes 0402 and 0603.

DIMENSIONS: inches (millimeters)

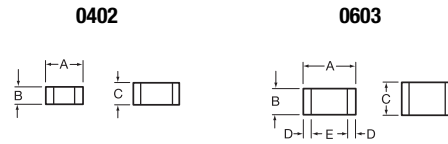

| Size | A | B | C | D | E |
|------|----------------------------|----------------------------|---------------------|----------------------------|---------------------|
| 0402 | 0.039±0.004 (1.00±0.1) | 0.020±0.004 (0.50±0.1) | 0.024 max (0.6) | N/A | N/A |
| 0603 | 0.060±0.010 (1.52±0.25) | 0.030±0.010 (0.76±0.25) | 0.036 max (0.91) | 0.010±0.005 (0.25±0.13) | 0.030 min (0.76) |

HOW TO ORDER

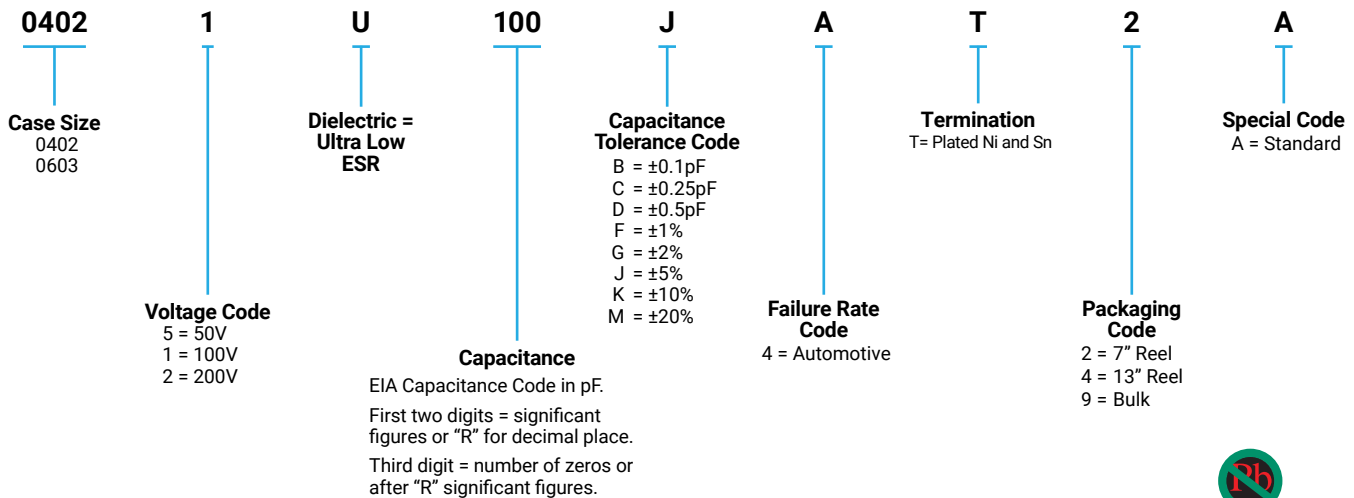

ELECTRICAL CHARACTERISTICS

Capacitance Values and Tolerances:

Size 0402 - 0.2 pF to 22 pF @ 1 MHz
Size 0603 - 1.0 pF to 100 pF @ 1 MHz

Temperature Coefficient of Capacitance (TC):

0±30 ppm/°C (-55° to +125°C)

Insulation Resistance (IR):

10¹² Ω min. @ 25°C and rated WVDC
10¹¹ Ω min. @ 125°C and rated WVDC

Working Voltage (WVDC):

Size Working Voltage
0402 - 100, 50, 25 WVDC
0603 - 200, 100, 50 WVDC

Dielectric Working Voltage (DWV):

250% of rated WVDC

Equivalent Series Resistance Typical (ESR):

0402 - See Performance Curve, page 303
0603 - See Performance Curve, page 303

Automotive Specifications

Meets or exceeds the requirements of AEC Q200



LEAD-FREE
LEAD-FREE COMPATIBLE
COMPONENT



U Dielectric

RF/Microwave Automotive C0G (NP0) Capacitors (RoHS)

AEC Q200 Qualified, Ultra Low ESR, "U" Series, C0G (NP0) Chip Capacitors



CAPACITANCE RANGE

| Cap (pF) | Available Tolerance | Size 0402 | Size 0603 |
|----------|---------------------|-----------|-----------|
| 0.2 | B,C | 50V | N/A |
| 0.3 | | | |
| 0.4 | | | |
| 0.5 | B,C | | |
| 0.6 | B,C,D | | |
| 0.7 | | | |
| 0.8 | | | |
| 0.9 | B,C,D | | |

| Cap (pF) | Available Tolerance | Size 0402 | Size 0603 |
|----------|---------------------|-----------|-----------|
| 1.0 | B,C,D | 50V | 200V |
| 1.1 | | | |
| 1.2 | | | |
| 1.3 | | | |
| 1.4 | | | |
| 1.5 | | | |
| 1.6 | | | |
| 1.7 | | | |
| 1.8 | | | |
| 1.9 | | | |
| 2.0 | | | |
| 2.1 | | | |
| 2.2 | | | |
| 2.4 | | | |
| 2.7 | | | |
| 3.0 | | | |
| 3.3 | | | |
| 3.6 | | | |
| 3.9 | | | |
| 4.3 | | | |
| 4.7 | | | |
| 5.1 | | | |
| 5.6 | | | |
| 6.2 | B,C,D | | |
| 6.8 | B,C,J,K,M | | |

| Cap (pF) | Available Tolerance | Size 0402 | Size 0603 |
|----------|---------------------|-----------|-----------|
| 7.5 | B,C,J,K,M | 50V | 200V |
| 8.2 | | | |
| 9.1 | B,C,J,K,M | | |
| 10 | F,G,J,K,M | | |
| 11 | | | |
| 12 | | | |
| 13 | | | |
| 15 | | | |
| 18 | | | |
| 20 | | | |
| 22 | | | |
| 24 | | | |
| 27 | | | |
| 30 | | | |
| 33 | | | |
| 36 | | | |
| 39 | | | |
| 43 | | | |
| 47 | | | |
| 51 | | | |
| 56 | | | |
| 68 | | | |
| 75 | | | |
| 82 | | | |
| 91 | | | |

| Cap (pF) | Available Tolerance | Size 0402 | Size 0603 |
|----------|---------------------|-----------|-----------|
| 100 | F,G,J,K,M | N/A | 100V |
| 110 | | | 50V |
| 120 | | | 50V |
| 130 | | | N/A |
| 140 | | | |
| 150 | | | |
| 160 | | | |
| 180 | | | |
| 200 | | | |
| 220 | | | |
| 270 | | | |
| 300 | | | |
| 330 | | | |
| 360 | | | |
| 390 | | | |
| 430 | | | |
| 470 | | | |
| 510 | | | |
| 560 | | | |
| 620 | | | |
| 680 | | | |
| 750 | | | |
| 820 | | | |
| 910 | | | |
| 1000 | F,G,J,K,M | | |

ULTRA LOW ESR, "U" SERIES

TYPICAL ESR vs. FREQUENCY
0402 "U" SERIES

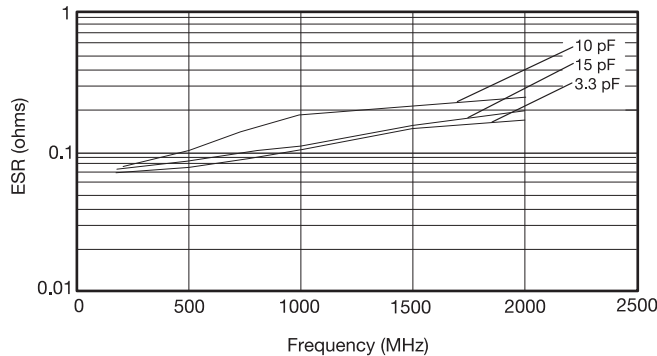

TYPICAL ESR vs. FREQUENCY
0603 "U" SERIES

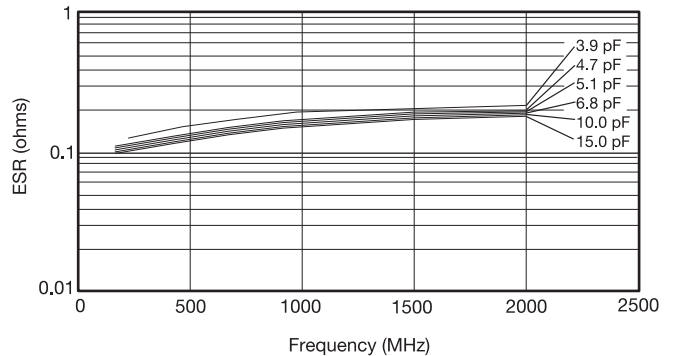

TYPICAL
SERIES RESONANT FREQUENCY
"U" SERIES CHIP

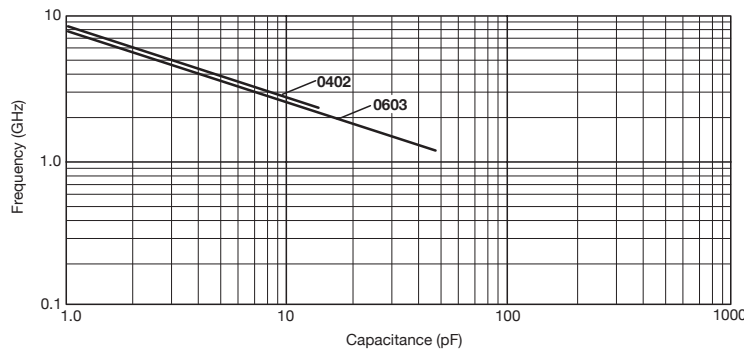

0402

| Kit 5000 UZ | | | |
|---------------|------------|---------------|-------------|
| Cap. Value PF | Tolerance | Cap. Value pF | Tolerance |
| 0.5 | B (±0.1pF) | 4.7 | B (± 0.1pF) |
| 1.0 | | 5.6 | |
| 1.5 | | 6.8 | |
| 1.8 | | 8.2 | |
| 2.2 | | 10.0 | |
| 2.4 | | 12.0 | |
| 3.0 | J (±5%) | 15.0 | J (±5%) |
| 3.6 | | | |

***25 each of 15 values

0603

| Kit 4000 UZ | | | |
|---------------|------------|---------------|------------|
| Cap. Value PF | Tolerance | Cap. Value pF | Tolerance |
| 1.0 | B (±0.1pF) | 6.8 | B (±0.1pF) |
| 1.2 | | 7.5 | |
| 1.5 | | 8.2 | |
| 1.8 | | 10.0 | |
| 2.0 | | 12.0 | |
| 2.4 | | 15.0 | |
| 2.7 | J (±5%) | 18.0 | J (±5%) |
| 3.0 | | 22.0 | |
| 3.3 | | 27.0 | |
| 3.9 | | 33.0 | |
| 4.7 | | 39.0 | |
| 5.6 | | 47.0 | |

***25 each of 24 values

0805

| Kit 3000 UZ | | | | | |
|---------------|------------|---------------|-----------|-------|---------|
| Cap. Value PF | Tolerance | Cap. Value pF | Tolerance | | |
| 1.0 | B (±0.1pF) | 15.0 | J (±5%) | | |
| 1.5 | | 18.0 | | | |
| 2.2 | | 22.0 | | | |
| 2.4 | | 24.0 | | | |
| 2.7 | | 27.0 | | | |
| 3.0 | | 33.0 | | | |
| 3.3 | | 36.0 | | | |
| 3.9 | | 39.0 | | | |
| 4.7 | | 47.0 | | | |
| 5.6 | | 56.0 | | | |
| 7.5 | | 68.0 | | | |
| 8.2 | | 82.0 | | | |
| 10.0 | | J (±5%) | | 100.0 | J (±5%) |
| 12.0 | | | | 130.0 | |

***25 each of 30 values

1210

| Kit 3500 UZ | | | |
|---------------|------------|---------------|-----------|
| Cap. Value PF | Tolerance | Cap. Value pF | Tolerance |
| 2.2 | B (±0.1pF) | 36.0 | J (±5%) |
| 2.7 | | 39.0 | |
| 4.7 | | 47.0 | |
| 5.1 | | 51.0 | |
| 6.8 | | 56.0 | |
| 8.2 | | 68.0 | |
| 9.1 | | 82.0 | |
| 10.0 | | J (± 5%) | |
| 13.0 | 120.0 | | |
| 15.0 | 130.0 | | |
| 18.0 | 240.0 | | |
| 20.0 | 300.0 | | |
| 24.0 | 390.0 | | |
| 27.0 | 470.0 | | |
| 30.0 | 680.0 | | |

***25 each of 30 values

X8R/X8L Dielectric

General Specifications

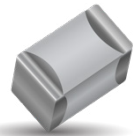
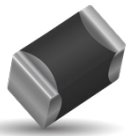

AVX has developed a range of multilayer ceramic capacitors designed for use in applications up to 150°C. These capacitors are manufactured with an X8R and an X8L dielectric material. X8R material has capacitance variation of $\pm 15\%$ between -55°C and +150°C. The X8L material has capacitance variation of $\pm 15\%$ between -55°C to 125°C to 125°C and +15/40% from +125°C to +150°C.

The need for X8R and X8L performance has been driven by customer requirements for parts that operate at elevated temperatures. They provide a highly reliable capacitor with low loss and stable capacitance over temperature.

They are ideal for automotive under the hood sensors, and various industrial applications. Typical industrial application would be drilling monitoring system. They can also be used as bulk capacitors for high temperature camera modules.

Both X8R and X8L dielectric capacitors are automotive AEC-Q200 qualified. Optional termination systems, tin, FLEXITERM® and conductive epoxy for hybrid applications are available. Providing this series with our FLEXITERM® termination system provides further advantage to customers by way of enhanced resistance to both, temperature cycling and mechanical damage.

| | | | | | | | | |
|------------------------------|--|--------------------|--|---|------------------------------------|--|-----------------------------|---------------------|
| 0805 | 5 | A | 104 | K | 4 | T | 2 | A |
| Size | Voltage | Dielectric | Capacitance Code (in pF) | Capacitance Tolerance | Failure Rate | Terminations | Packaging | Special Code |
| 0402 0603 0805 1206 | 10V = Z 16V = Y 25V = 3 50V = 5 100V = 1 | X8R = F X8L = L | 2 Sig. Digits + Number of Zeros e.g. 10 F = 106 | J = $\pm 5\%$ K = $\pm 10\%$ M = $\pm 20\%$ | 4=Automotive A = Not Applicable | T = Plated Ni and Sn Z = FLEXITERM®** | 2 = 7" Reel 4 = 13" Reel | A = Std. Product |

NOTE: Contact factory for availability of Termination and Tolerance Options for Specific Part Numbers.

X8R

| Size | Soldering | 0603 | | 0805 | | 1206 | |
|------|-----------|-------------|-------------|-------------|-------------|-------------|-------------|
| | | Reflow/Wave | Reflow/Wave | Reflow/Wave | Reflow/Wave | Reflow/Wave | Reflow/Wave |
| | WVDC | 25V | 50V | 25V | 50V | 25V | 50V |
| 271 | Cap | 270 | G | G | | | |
| 331 | (pF) | 330 | G | G | J | J | |
| 471 | | 470 | G | G | J | J | |
| 681 | | 680 | G | G | J | J | |
| 102 | | 1000 | G | G | J | J | J |
| 152 | | 1500 | G | G | J | J | J |
| 222 | | 2200 | G | G | J | J | J |
| 332 | | 3300 | G | G | J | J | J |
| 472 | | 4700 | G | G | J | J | J |
| 682 | | 6800 | G | G | J | J | J |
| 103 | Cap | 0.01 | G | G | J | J | J |
| 153 | (µF) | 0.015 | G | G | J | J | J |
| 223 | | 0.022 | G | G | J | J | J |
| 333 | | 0.033 | G | G | J | J | J |
| 473 | | 0.047 | G | G | J | J | J |
| 683 | | 0.068 | G | | N | N | M |
| 104 | | 0.1 | | | N | N | M |
| 154 | | 0.15 | | | N | N | M |
| 224 | | 0.22 | | | N | | M |
| 334 | | 0.33 | | | | | M |
| 474 | | 0.47 | | | | | M |
| 684 | | 0.68 | | | | | |
| 105 | | 1 | | | | | |
| 155 | | 1.5 | | | | | |
| 225 | | 2.2 | | | | | |
| | WVDC | 25V | 50V | 25V | 50V | 25V | 50V |
| SIZE | | 0603 | | 0805 | | 1206 | |

X8L

| Size | Soldering | 0603 | | | 0805 | | | 1206 | | | 1210 | | | |
|------|-----------|-------------|-------------|-------------|-------------|-------------|-------------|-------------|-------------|-------------|-------------|-------------|-----|------|
| | | Reflow/Wave | Reflow/Wave | Reflow/Wave | Reflow/Wave | Reflow/Wave | Reflow/Wave | Reflow/Wave | Reflow/Wave | Reflow/Wave | Reflow/Wave | Reflow/Wave | | |
| | WVDC | 25V | 50V | 100V | 25V | 50V | 100V | 16V | 25V | 50V | 100V | 10V | 50V | 100V |
| 271 | Cap | 270 | G | G | | | | | | | | | | |
| 331 | (pF) | 330 | G | G | G | J | J | J | | | | | | |
| 471 | | 470 | G | G | G | J | J | J | | | | | | |
| 681 | | 680 | G | G | G | J | J | J | | | | | | |
| 102 | | 1000 | G | G | G | J | J | J | | | | | | |
| 152 | | 1500 | G | G | G | J | J | J | | | | | | |
| 222 | | 2200 | G | G | G | J | J | J | | | | | | |
| 332 | | 3300 | G | G | G | J | J | J | | | | | | |
| 472 | | 4700 | G | G | G | J | J | J | | | | | | |
| 682 | | 6800 | G | G | G | J | J | J | | | | | | |
| 103 | Cap | 0.01 | G | G | G | J | J | J | | | | | | |
| 123 | (µF) | 0.012 | G | G | | J | J | J | | | | | | |
| 153 | | 0.015 | G | G | | J | J | J | | | | | | |
| 183 | | 0.018 | G | G | | J | J | J | | | | | | |
| 223 | | 0.022 | G | G | | J | J | J | | | | | | |
| 273 | | 0.027 | G | G | | J | J | J | | | | | | |
| 333 | | 0.033 | G | G | | J | J | N | | | | | | |
| 393 | | 0.039 | G | G | | J | J | N | | | | | | |
| 473 | | 0.047 | G | G | | J | J | N | | | | | | |
| 563 | | 0.056 | G | G | | J | J | N | | | | | | |
| 683 | | 0.068 | G | G | | J | J | N | | | | | | |
| 823 | | 0.082 | G | G | | J | J | N | | | | | | |
| 104 | | 0.1 | G | G | | J | J | N | | | | | | |
| 124 | | 0.12 | | | | J | N | | | | | | | |
| 154 | | 0.15 | | | | J | N | | | | | | | |
| 184 | | 0.18 | | | | N | N | | | | | | | |
| 224 | | 0.22 | | | | N | N | | | | | | | |
| 274 | | 0.27 | | | | N | | | | | | | | |
| 334 | | 0.33 | | | | N | | | | | | | | |
| 394 | | 0.39 | | | | N | | | | | | | | |
| 474 | | 0.47 | | | | N | | | | | | | | |
| 684 | | 0.68 | | | | N | | | | | | | | |
| 824 | | 0.82 | | | | N | | | | | | | | |
| 105 | | 1 | | | | N | | | | | | | | |
| 155 | | 1.5 | | | | | | | | | | | | |
| 225 | | 2.2 | | | | | | | | | | | | |
| 475 | | | | | | | | | | | | | | |
| 106 | | | | | | | | | | | | | | |
| | WVDC | 25V | 50V | 100V | 25V | 50V | 100V | 16V | 25V | 50V | 100V | 10V | 50V | 100V |
| SIZE | | 0603 | | | 0805 | | | 1206 | | | | | | |

| Size | 0603 | 0805 | 1206 | 1210 | |
|--------------|-------------|--------------------------------|--------------------------------|--------------------------------|--------------------------------|
| Soldering | Reflow/Wave | Reflow/Wave | Reflow/Wave | Reflow/Wave | |
| Packaging | All Paper | Paper/Embossed | Paper/Embossed | Paper/Embossed | |
| (L) Length | mm (in) | 1.60 ± 0.15 (0.063 ± 0.006) | 2.01 ± 0.20 (0.079 ± 0.008) | 3.20 ± 0.20 (0.126 ± 0.008) | 3.30 ± 0.4 (0.130 ± 0.016) |
| (W) Width | mm (in) | 0.81 ± 0.15 (0.032 ± 0.006) | 1.25 ± 0.20 (0.049 ± 0.008) | 1.60 ± 0.20 (0.063 ± 0.008) | 2.50 ± 0.20 (0.098 ± 0.008) |
| (t) Terminal | mm (in) | 0.35 ± 0.15 (0.014 ± 0.006) | 0.50 ± 0.25 (0.020 ± 0.010) | 0.50 ± 0.25 (0.020 ± 0.010) | 0.50 ± 0.25 (0.020 ± 0.010) |

| Letter | A | C | E | G | J | K | M | N | P | Q | X | Y | Z |
|----------------|----------|----------|----------|----------|----------|----------|---------|----------|---------|---------|---------|--------|---------|
| Max. Thickness | 0.33 | 0.56 | 0.71 | 0.9 | 0.94 | 1.02 | 1.27 | 1.4 | 1.52 | 1.78 | 2.29 | 2.54 | 2.79 |
| | (-0.013) | (-0.022) | (-0.028) | (-0.035) | (-0.037) | (-0.04) | (-0.05) | (-0.055) | (-0.06) | (-0.07) | (-0.09) | (-0.1) | (-0.11) |
| | PAPER | | | | | EMBOSSED | | | | | | | |

 = AEC-Q200 Qualified

X8R/X8L Dielectric

General Specifications

APPLICATIONS FOR X8R AND X8L CAPACITORS

- All market sectors with a 150°C requirement
- Automotive on engine applications
- Oil exploration applications
- Hybrid automotive applications
 - Battery control
 - Inverter / converter circuits
 - Motor control applications
 - Water pump
- Hybrid commercial applications
 - Emergency circuits
 - Sensors
 - Temperature regulation

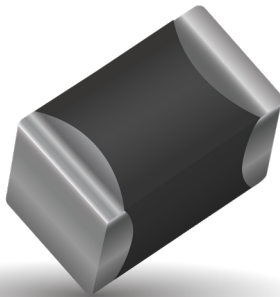

ADVANTAGES OF X8R AND X8L MLC CAPACITORS

- Both ranges are qualified to the highest automotive AEC-Q200 standards
- Excellent reliability compared to other capacitor technologies
- RoHS compliant
- Low ESR / ESL compared to other technologies
- Tin solder finish
- FLEXITERM[®] available
- Epoxy termination for hybrid available
- 100V range available

ENGINEERING TOOLS FOR HIGH VOLTAGE MLC CAPACITORS

- Samples
- Technical Articles
- Application Engineering
- Application Support

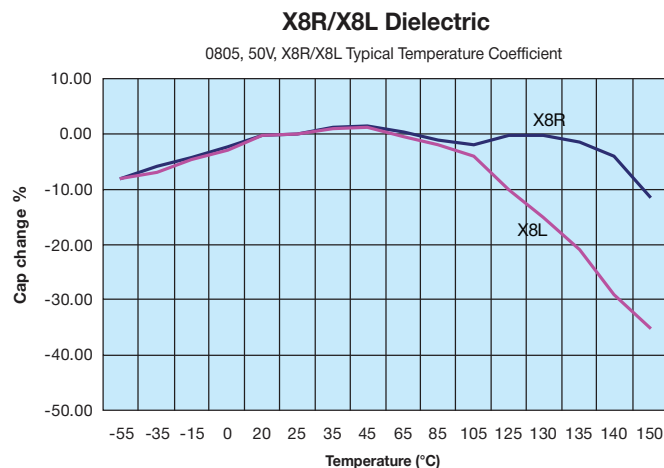

X8R/X8L Dielectric

Specifications and Test Methods

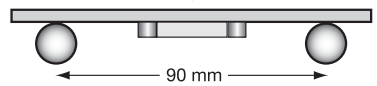
| Parameter/Test | | X8R/X8L Specification Limits | Measuring Conditions | |
|--------------------------------------|-----------------------|---|--|----------------|
| Operating Temperature Range | | -55°C to +150°C | Temperature Cycle Chamber | |
| Capacitance | | Within specified tolerance | Freq.: 1.0 kHz ± 10% Voltage: 1.0Vrms ± .2V | |
| Dissipation Factor | | ≤ 2.5% for ≥ 50V DC rating ≤ 3.5% for 25V DC and 16V DC rating | | |
| Insulation Resistance | | 100,000MΩ or 1000MΩ - μF, whichever is less | Charge device with rated voltage for 120 ± 5 secs @ room temp/humidity | |
| Dielectric Strength | | No breakdown or visual defects | Charge device with 250% of rated voltage for 1-5 seconds, w/charge and discharge current limited to 50 mA (max) Note: Charge device with 150% of rated voltage for 500V devices. | |
| Resistance to Flexure Stresses | Appearance | No defects | Deflection: 2mm Test Time: 30 seconds 1mm/sec  | |
| | Capacitance Variation | ≤ ±12% | | |
| | Dissipation Factor | Meets Initial Values (As Above) | | |
| | Insulation Resistance | ≥ Initial Value x 0.3 | | |
| Solderability | | ≥ 95% of each terminal should be covered with fresh solder | Dip device in eutectic solder at 230 ± 5°C for 5.0 ± 0.5 seconds | |
| Resistance to Solder Heat | Appearance | No defects, <25% leaching of either end terminal | Dip device in eutectic solder at 260°C for 60 seconds. Store at room temperature for 24 ± 2 hours before measuring electrical properties. | |
| | Capacitance Variation | ≤ ±7.5% | | |
| | Dissipation Factor | Meets Initial Values (As Above) | | |
| | Insulation Resistance | Meets Initial Values (As Above) | | |
| | Dielectric Strength | Meets Initial Values (As Above) | | |
| Thermal Shock | Appearance | No visual defects | Step 1: -55°C ± 2° | 30 ± 3 minutes |
| | Capacitance Variation | ≤ ±7.5% | Step 2: Room Temp | ≤ 3 minutes |
| | Dissipation Factor | Meets Initial Values (As Above) | Step 3: +125°C ± 2° | 30 ± 3 minutes |
| | Insulation Resistance | Meets Initial Values (As Above) | Step 4: Room Temp | ≤ 3 minutes |
| | Dielectric Strength | Meets Initial Values (As Above) | Repeat for 5 cycles and measure after 24 ± 2 hours at room temperature | |
| Load Life | Appearance | No visual defects | Charge device with 1.5 rated voltage (≤ 10V) in test chamber set at 150°C ± 2°C for 1000 hours (+48, -0) Remove from test chamber and stabilize at room temperature for 24 ± 2 hours before measuring. | |
| | Capacitance Variation | ≤ ±12.5% | | |
| | Dissipation Factor | ≤ Initial Value x 2.0 (See Above) | | |
| | Insulation Resistance | ≥ Initial Value x 0.3 (See Above) | | |
| | Dielectric Strength | Meets Initial Values (As Above) | | |
| Load Humidity | Appearance | No visual defects | Store in a test chamber set at 85°C ± 2°C/ 85% ± 5% relative humidity for 1000 hours (+48, -0) with rated voltage applied. Remove from chamber and stabilize at room temperature and humidity for 24 ± 2 hours before measuring.. | |
| | Capacitance Variation | ≤ ±12.5% | | |
| | Dissipation Factor | ≤ Initial Value x 2.0 (See Above) | | |
| | Insulation Resistance | ≥ Initial Value x 0.3 (See Above) | | |
| | Dielectric Strength | Meets Initial Values (As Above) | | |

X7R Dielectric

General Specifications

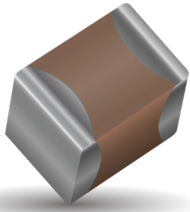

X7R formulations are called “temperature stable” ceramics and fall into EIA Class II materials. X7R is the most popular of these intermediate dielectric constant materials. Its temperature variation of capacitance is within $\pm 15\%$ from -55°C to $+125^{\circ}\text{C}$. This capacitance change is non-linear.

Capacitance for X7R varies under the influence of electrical operating conditions such as voltage and frequency.

X7R dielectric chip usage covers the broad spectrum of industrial applications where known changes in capacitance due to applied voltages are acceptable.



PART NUMBER (SEE PAGE 4 FOR COMPLETE PART NUMBER EXPLANATION)

| | | | | | | | | |
|--------------------------|--|------------------------------|--|---|---|--|---|---|
| 0805 | 5 | C | 103 | M | A | T | 2 | A |
| Size (L" x W") | Voltage 4V = 4 6.3V = 6 10V = Z 16V = Y 25V = 3 50V = 5 100V = 1 200V = 2 500V = 7 | Dielectric X7R = C | Capacitance Code (In pF) 2 Sig. Digits + Number of Zeros | Capacitance Tolerance J = $\pm 5\%$ * K = $\pm 10\%$ M = $\pm 20\%$ | Failure Rate A = Not Applicable | Terminations T = Plated Ni and Sn Z = FLEXITERM®** *Optional termination **See FLEXITERM® X7R section | Packaging 2 = 7" Reel 4 = 13" Reel | Special Code A = Std. Product |
| | | | | * $\leq 1\mu\text{F}$ only, contact factory for additional values | | | Contact Factory For Multiples | |

NOTE: Contact factory for availability of Termination and Tolerance Options for Specific Part Numbers. Contact factory for non-specified capacitance values.

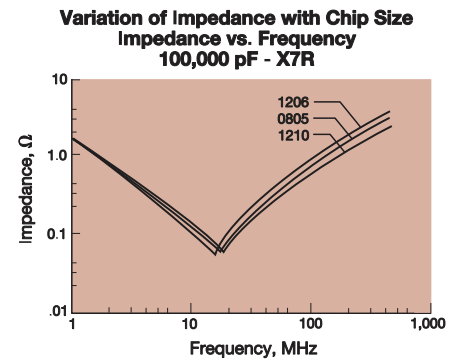
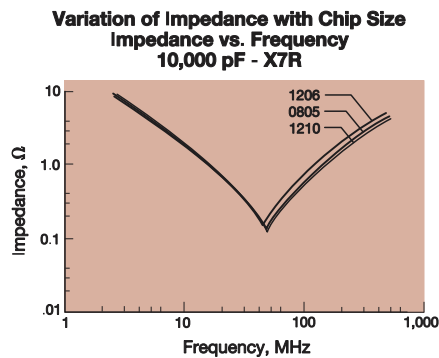
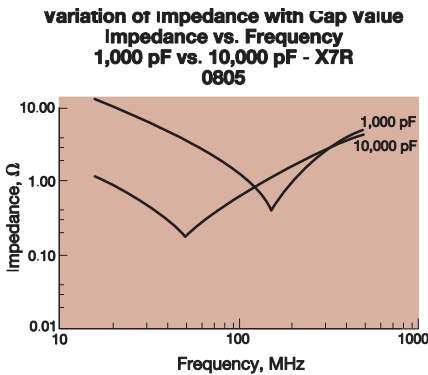
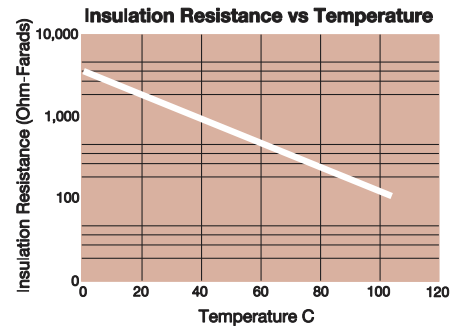
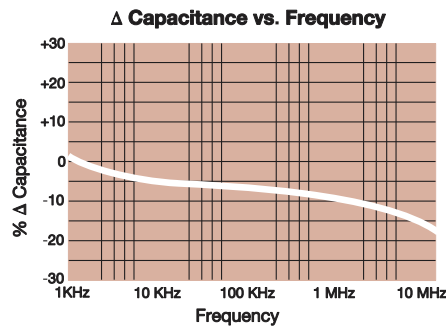
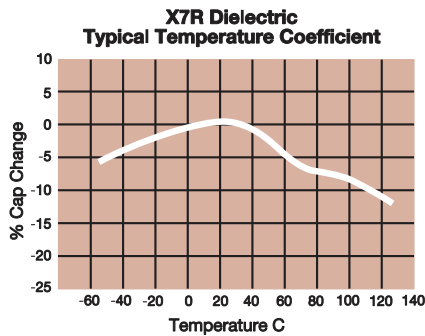

X7R Dielectric

Specifications and Test Methods



| Parameter/Test | | X7R Specification Limits | Measuring Conditions | |
|---------------------------------------|---------------------------------|--|---|--------------------|
| Operating Temperature Range | | -55°C to +125°C | Temperature Cycle Chamber | |
| Capacitance | | Within specified tolerance | Freq.: 1.0 kHz \pm 10% Voltage: 1.0Vrms \pm .2V For Cap > 10 μ F, 0.5Vrm @ 120Hz | |
| Dissipation Factor | | \leq 10% for \geq 50V DC rating \leq 12.5% for 25V DC rating \leq 12.5% for \leq 10V DC rating Contact Factory for DF by PN | | |
| Insulation Resistance | | 100,000M Ω or 1000M Ω - μ F, whichever is less | Charge device with rated voltage for 120 \pm 5 secs @ room temp/humidity | |
| Dielectric Strength | | No breakdown or visual defects | Charge device with 250% of rated voltage for 1-5 seconds, w/charge and discharge current limited to 50 mA (max) Note: Charge device with 150% of rated voltage for 500V devices. | |
| Resistance to Flexure Stresses | Appearance | No defects | Deflection: 2mm Test Time: 30 seconds | |
| | Capacitance Variation | $\leq \pm 12\%$ | | |
| | Dissipation Factor | Meets Initial Values (As Above) | | |
| | Insulation Resistance | \geq Initial Value x 0.3 | | |
| Solderability | | \geq 95% of each terminal should be covered with fresh solder | Dip device in eutectic solder at 230 \pm 5°C for 5.0 \pm 0.5 seconds | |
| Resistance to Solder Heat | Appearance | No defects, <25% leaching of either end terminal | Dip device in eutectic solder at 260°C for 60 seconds. Store at room temperature for 24 \pm 2hours before measuring electrical properties. | |
| | Capacitance Variation | $\leq \pm 7.5\%$ | | |
| | Dissipation Factor | Meets Initial Values (As Above) | | |
| | Insulation Resistance | Meets Initial Values (As Above) | | |
| Thermal Shock | Dielectric Strength | Meets Initial Values (As Above) | | |
| | Appearance | No visual defects | Step 1: -55°C \pm 2° | 30 \pm 3 minutes |
| | Capacitance Variation | $\leq \pm 7.5\%$ | Step 2: Room Temp | \leq 3 minutes |
| | Dissipation Factor | Meets Initial Values (As Above) | Step 3: +125°C \pm 2° | 30 \pm 3 minutes |
| | Insulation Resistance | Meets Initial Values (As Above) | Step 4: Room Temp | \leq 3 minutes |
| Load Life | Dielectric Strength | Meets Initial Values (As Above) | Repeat for 5 cycles and measure after 24 \pm 2 hours at room temperature | |
| | Appearance | No visual defects | Charge device with \geq rated voltage in test chamber set at 125°C \pm 2°C for 1000 hours (+48, -0). Remove from test chamber and stabilize at room temperature for 24 \pm 2 hours before measuring. Contact AVX for datasheet of specific parts. | |
| | Capacitance Variation | $\leq \pm 12.5\%$ | | |
| | Dissipation Factor | \leq Initial Value x 2.0 (See Above) | | |
| | Insulation Resistance | \geq Initial Value x 0.3 (See Above) | | |
| Dielectric Strength | Meets Initial Values (As Above) | | | |
| Load Humidity | Dielectric Strength | Meets Initial Values (As Above) | Store in a test chamber set at 85°C \pm 2°C/ 85% \pm 5% relative humidity for 1000 hours (+48, -0) with rated voltage applied. | |
| | Appearance | No visual defects | Remove from chamber and stabilize at room temperature and humidity for 24 \pm 2 hours before measuring. | |
| | Capacitance Variation | $\leq \pm 12.5\%$ | | |
| | Dissipation Factor | \leq Initial Value x 2.0 (See Above) | | |
| | Insulation Resistance | \geq Initial Value x 0.3 (See Above) | | |

X7R Dielectric Capacitance Range

PREFERRED SIZES ARE SHADED

| SIZE | 1210 | | | | | | | | 1812 | | | | | 1825 | | | 2220 | | | | | 2225 | | | | |
|--------------|----------------|--------------------------------|----|----|----|-----|-----|-----|--------------|--------------------------------|----|-----|-----|--------------|--------------------------------|-----|--------------|--------------------------------|----|-----|-----|--------------|--------------------------------|-----|-----|---|
| Soldering | Reflow Only | | | | | | | | Reflow Only | | | | | Reflow Only | | | Reflow Only | | | | | Reflow Only | | | | |
| Packaging | Paper/Embossed | | | | | | | | All Embossed | | | | | All Embossed | | | All Embossed | | | | | All Embossed | | | | |
| (L) Length | mm (in.) | 3.30 ± 0.4 (0.130 ± 0.016) | | | | | | | | 4.50 ± 0.40 (0.177 ± 0.016) | | | | | 4.50 ± 0.40 (0.177 ± 0.016) | | | 5.70 ± 0.50 (0.224 ± 0.020) | | | | | 5.70 ± 0.40 (0.224 ± 0.016) | | | |
| (W) Width | mm (in.) | 2.50 ± 0.30 (0.098 ± 0.012) | | | | | | | | 3.20 ± 0.40 (0.126 ± 0.016) | | | | | 6.40 ± 0.40 (0.252 ± 0.016) | | | 5.00 ± 0.40 (0.197 ± 0.016) | | | | | 6.30 ± 0.40 (0.248 ± 0.016) | | | |
| (t) Terminal | mm (in.) | 0.50 ± 0.25 (0.020 ± 0.010) | | | | | | | | 0.61 ± 0.36 (0.024 ± 0.014) | | | | | 0.61 ± 0.36 (0.024 ± 0.014) | | | 0.64 ± 0.39 (0.025 ± 0.015) | | | | | 0.64 ± 0.39 (0.025 ± 0.015) | | | |
| | WVDC | 10 | 16 | 25 | 50 | 100 | 200 | 500 | 16 | 25 | 50 | 100 | 200 | 500 | 50 | 100 | 200 | 25 | 50 | 100 | 200 | 500 | 50 | 100 | 200 | |
| Cap | 100 | 101 | | | | | | | | | | | | | | | | | | | | | | | | |
| (pF) | 150 | 151 | | | | | | | | | | | | | | | | | | | | | | | | |
| | 220 | 221 | | | | K | K | M | | | | | | | | | | | | | | | | | | |
| | 330 | 331 | | | | K | K | M | | | N | N | N | N | | | | | | | | | | | | |
| | 470 | 471 | | | | K | K | M | | | N | N | N | N | | | | | | | | | | | | |
| | 680 | 681 | | | | K | K | M | | | N | N | N | N | | | | | | | | | | | | |
| | 1000 | 102 | K | K | K | K | K | M | N | N | N | N | N | N | X | X | X | | X | X | X | X | X | X | X | X |
| | 1500 | 152 | K | K | K | K | K | M | N | N | N | N | N | N | X | X | X | | X | X | X | X | X | X | X | X |
| | 2200 | 222 | K | K | K | K | K | M | N | N | N | N | N | N | X | X | X | | X | X | X | X | X | X | X | X |
| | 3300 | 332 | K | K | K | K | K | P | N | N | N | N | N | N | X | X | X | | X | X | X | X | X | X | X | X |
| | 4700 | 472 | K | K | K | K | K | P | N | N | N | N | N | P | X | X | X | | X | X | X | X | X | X | X | X |
| | 6800 | 682 | K | K | K | K | K | P | N | N | N | N | N | P | X | X | X | | X | X | X | X | X | X | X | X |
| Cap | 0.01 | 103 | K | K | K | K | K | P | N | N | N | N | N | P | X | X | X | | X | X | X | X | X | X | X | X |
| (µF) | 0.015 | 153 | K | K | K | K | K | P | N | N | N | N | N | P | X | X | X | | X | X | X | X | X | X | X | X |
| | 0.022 | 223 | K | K | K | K | K | P | N | N | N | N | N | P | X | X | X | | X | X | X | X | X | X | X | X |
| | 0.033 | 333 | K | K | K | K | K | P | N | N | N | N | N | X | X | X | X | | X | X | X | X | X | X | X | X |
| | 0.047 | 473 | K | K | K | K | K | P | N | N | N | N | N | P | X | X | X | | X | X | X | X | X | X | X | X |
| | 0.068 | 683 | K | K | K | K | K | P | N | N | N | N | N | P | X | X | X | | X | X | X | X | X | X | X | X |
| | 0.1 | 104 | K | K | K | K | K | P | N | N | N | N | N | P | X | X | X | | X | X | X | X | X | X | X | X |
| | 0.15 | 154 | K | K | K | M | P | Z | N | N | N | P | P | Z | X | X | X | | X | X | X | X | X | X | X | X |
| | 0.22 | 224 | K | K | K | M | P | Z | N | N | N | P | Q | Z | X | X | X | | X | X | X | X | X | X | X | X |
| | 0.33 | 334 | K | K | K | M | Q | Z | N | N | N | P | X | Z | X | X | X | | X | X | X | X | X | X | X | X |
| | 0.47 | 474 | M | M | M | P | Q | Z | N | N | N | Q | X | Z | X | X | X | | X | X | X | X | X | X | X | X |
| | 0.68 | 684 | M | M | P | X | X | Z | Q | Q | Q | Q | Z | | X | X | X | | X | X | X | | X | X | X | X |
| | 1.0 | 105 | P | P | P | X | Z | | Q | Q | Q | X | Z | | X | X | X | | X | X | X | | X | X | X | X |
| | 1.5 | 155 | N | N | Z | Z | Z | | | Z | Z | Z | | | X | X | Z | | X | X | Z | | X | X | Z | |
| | 2.2 | 225 | X | X | Z | Z | Z | | | Z | Z | Z | | | X | X | Z | | X | X | Z | | X | X | Z | |
| | 3.3 | 335 | X | X | Z | Z | Z | | | Z | Z | Z | | | X | X | | | X | Z | | | X | X | | |
| | 4.7 | 475 | Z | Z | Z | Z | Z | | | Z | Z | Z | | | X | X | | | Z | Z | | | X | X | | |
| | 10 | 106 | Z | Z | Z | Z | | | Z | Z | Z | | | | Z | Z | | | Z | Z | | | Z | Z | | |
| | 22 | 226 | Z | Z | Z | | | | | | | | | | | | | | Z | | | | | | | |
| | 47 | 476 | Z | | | | | | | | | | | | | | | | | | | | | | | |
| | 100 | 107 | | | | | | | | | | | | | | | | | | | | | | | | |
| | WVDC | 10 | 16 | 25 | 50 | 100 | 200 | 500 | 16 | 25 | 50 | 100 | 200 | 500 | 50 | 100 | 200 | 25 | 50 | 100 | 200 | 500 | 50 | 100 | 200 | |
| SIZE | | 1210 | | | | | | | | 1812 | | | | | 1825 | | | 2220 | | | | | 2225 | | | |

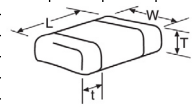

| Letter | A | B | C | E | G | J | K | M | N | P | Q | X | Y | Z |
|----------------|-----------------|-----------------|-----------------|-----------------|-----------------|-----------------|-----------------|-----------------|-----------------|-----------------|-----------------|-----------------|-----------------|-----------------|
| Max. Thickness | 0.33 (0.013) | 0.22 (0.009) | 0.56 (0.022) | 0.71 (0.028) | 0.90 (0.035) | 0.94 (0.037) | 1.02 (0.040) | 1.27 (0.050) | 1.40 (0.055) | 1.52 (0.060) | 1.78 (0.070) | 2.29 (0.090) | 2.54 (0.100) | 2.79 (0.110) |
| | PAPER | | | | | | EMBOSSD | | | | | | | |

NOTE: Contact factory for non-specified capacitance values

X7S Dielectric

General Specifications

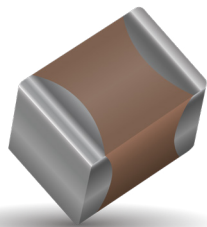

GENERAL DESCRIPTION

X7S formulations are called “temperature stable” ceramics and fall into EIA Class II materials. Its temperature variation of capacitances within $\pm 22\%$ from -55°C to $+125^{\circ}\text{C}$. This capacitance change is non-linear.

Capacitance for X7S varies under the influence of electrical operating conditions such as voltage and frequency.

X7S dielectric chip usage covers the broad spectrum of industrial applications where known changes in capacitance due to applied voltages are acceptable.

PART NUMBER (SEE PAGE 4 FOR COMPLETE PART NUMBER EXPLANATION)

| | | | | | | | | |
|--------------------------|--|------------------------------|--|--|--------------------------------|---|---|---|
| 1206 | Z | Z | 105 | M | A | T | 2 | A |
| Size (L" x W") | Voltage 4 = 4V 6 = 6.3V Z = 10V Y = 16V 3 = 25V 5 = 50V 1 = 100V 2 = 200V | Dielectric Z = X7S | Capacitance Code (In pF) 2 Sig. Digits + Number of Zeros | Capacitance Tolerance K = $\pm 10\%$ M = $\pm 20\%$ | Failure Rate A = N/A | Terminations T = Plated Ni and Sn | Packaging 2 = 7" Reel 4 = 13" Reel | Special Code A = Std. Product |

NOTE: Contact factory for availability of Tolerance Options for Specific Part Numbers.



TYPICAL ELECTRICAL CHARACTERISTICS

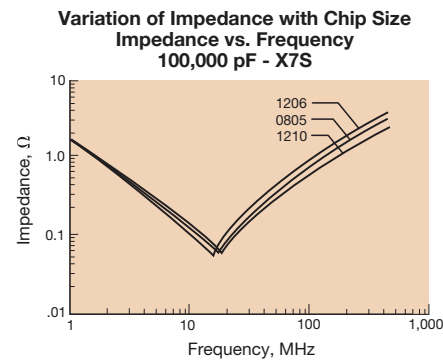
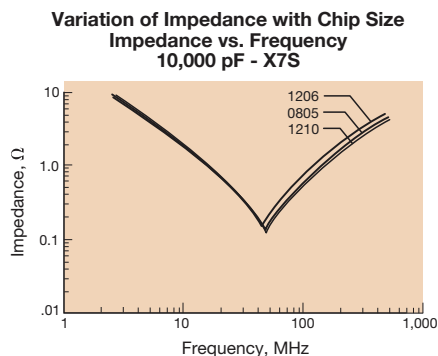
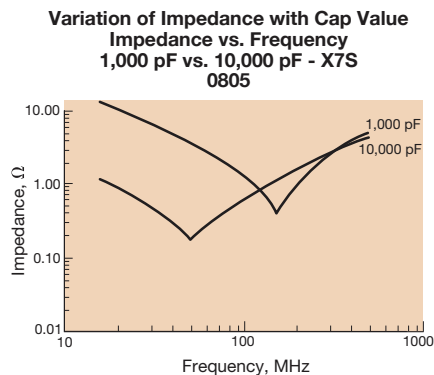
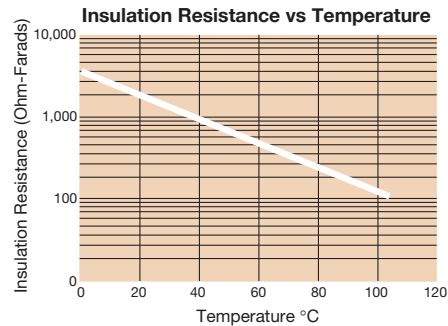
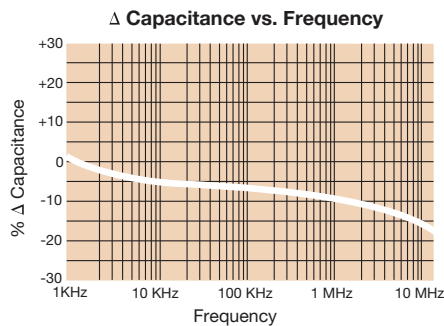
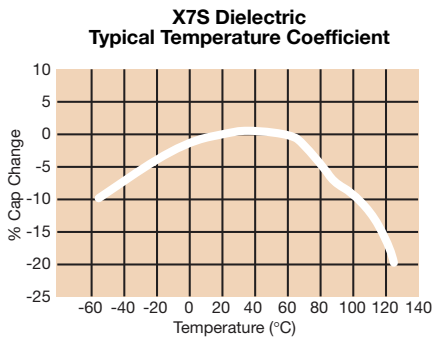

X7S Dielectric

Specifications and Test Methods

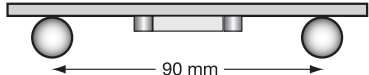
| Parameter/Test | | X7S Specification Limits | Measuring Conditions | |
|--------------------------------|-----------------------|---|---|--------------------|
| Operating Temperature Range | | -55°C to +125°C | Temperature Cycle Chamber | |
| Capacitance | | Within specified tolerance | Freq.: 1.0 kHz \pm 10% Voltage: 1.0Vrms \pm .2V For Cap > 10 μ F, 0.5Vrms @ 120Hz | |
| Dissipation Factor | | \leq 5.0% for \geq 100V DC rating \leq 5.0% for \geq 25V DC rating \leq 10.0% for \geq 10V DC rating \leq 10.0% for \leq 10V DC rating Contact Factory for DF by PN | | |
| Insulation Resistance | | 100,000M Ω or 1000M Ω - μ F, whichever is less | Charge device with rated voltage for 120 \pm 5 secs @ room temp/humidity | |
| Dielectric Strength | | No breakdown or visual defects | Charge device with 250% of rated voltage for 1-5 seconds, w/charge and discharge current limited to 50 mA (max) | |
| Resistance to Flexure Stresses | Appearance | No defects | Deflection: 2mm Test Time: 30 seconds  1mm/sec | |
| | Capacitance Variation | $\leq \pm 12\%$ | | |
| | Dissipation Factor | Meets Initial Values (As Above) | | |
| | Insulation Resistance | \geq Initial Value \times 0.3 | | |
| Solderability | | \geq 95% of each terminal should be covered with fresh solder | Dip device in eutectic solder at 230 \pm 5°C for 5.0 \pm 0.5 seconds | |
| Resistance to Solder Heat | Appearance | No defects, <25% leaching of either end terminal | Dip device in eutectic solder at 260°C for 60 seconds. Store at room temperature for 24 \pm 2 hours before measuring electrical properties. | |
| | Capacitance Variation | $\leq \pm 7.5\%$ | | |
| | Dissipation Factor | Meets Initial Values (As Above) | | |
| | Insulation Resistance | Meets Initial Values (As Above) | | |
| | Dielectric Strength | Meets Initial Values (As Above) | | |
| Thermal Shock | Appearance | No visual defects | Step 1: -55°C \pm 2° | 30 \pm 3 minutes |
| | Capacitance Variation | $\leq \pm 7.5\%$ | Step 2: Room Temp | \leq 3 minutes |
| | Dissipation Factor | Meets Initial Values (As Above) | Step 3: +125°C \pm 2° | 30 \pm 3 minutes |
| | Insulation Resistance | Meets Initial Values (As Above) | Step 4: Room Temp | \leq 3 minutes |
| | Dielectric Strength | Meets Initial Values (As Above) | Repeat for 5 cycles and measure after 24 \pm 2 hours at room temperature | |
| Load Life | Appearance | No visual defects | Charge device with 1.5 rated voltage (\leq 10V) in test chamber set at 125°C \pm 2°C for 1000 hours (+48, -0) Remove from test chamber and stabilize at room temperature for 24 \pm 2 hours before measuring. | |
| | Capacitance Variation | $\leq \pm 12.5\%$ | | |
| | Dissipation Factor | \leq Initial Value \times 2.0 (See Above) | | |
| | Insulation Resistance | \geq Initial Value \times 0.3 (See Above) | | |
| | Dielectric Strength | Meets Initial Values (As Above) | | |
| Load Humidity | Appearance | No visual defects | Store in a test chamber set at 85°C \pm 2°C/ 85% \pm 5% relative humidity for 1000 hours (+48, -0) with rated voltage applied. Remove from chamber and stabilize at room temperature and humidity for 24 \pm 2 hours before measuring. | |
| | Capacitance Variation | $\leq \pm 12.5\%$ | | |
| | Dissipation Factor | \leq Initial Value \times 2.0 (See Above) | | |
| | Insulation Resistance | \geq Initial Value \times 0.3 (See Above) | | |
| | Dielectric Strength | Meets Initial Values (As Above) | | |

X7S Dielectric Capacitance Range

PREFERRED SIZES ARE SHADED

| SIZE | 0402 | | 0603 | 0805 | 1206 | | | 1210 |
|--------------|-------------|-----------------|-----------------|-----------------|-----------------|----|-----|-----------------|
| Soldering | Reflow/Wave | | Reflow/Wave | Reflow/Wave | Reflow/Wave | | | Reflow Only |
| Packaging | All Paper | | All Paper | Paper/Embossed | Paper/Embossed | | | Paper/Embossed |
| (L) Length | mm | 1.00 ± 0.10 | 1.60 ± 0.15 | 2.01 ± 0.20 | 3.20 ± 0.20 | | | 3.20 ± 0.20 |
| | (in.) | (0.040 ± 0.004) | (0.063 ± 0.006) | (0.079 ± 0.008) | (0.126 ± 0.008) | | | (0.126 ± 0.008) |
| W) Width | mm | 0.50 ± 0.10 | 0.81 ± 0.15 | 1.25 ± 0.20 | 1.60 ± 0.20 | | | 2.50 ± 0.20 |
| | (in.) | (0.020 ± 0.004) | (0.032 ± 0.006) | (0.049 ± 0.008) | (0.063 ± 0.008) | | | (0.098 ± 0.008) |
| (t) Terminal | mm | 0.25 ± 0.15 | 0.35 ± 0.15 | 0.50 ± 0.25 | 0.50 ± 0.25 | | | 0.50 ± 0.25 |
| | (in.) | (0.010 ± 0.006) | (0.014 ± 0.006) | (0.020 ± 0.010) | (0.020 ± 0.010) | | | (0.020 ± 0.010) |
| WVDC | 4 | 6.3 | 6.3 | 4 | 10 | 50 | 100 | 6.3 |
| Cap (pF) | 100 | | | | | | | |
| | 150 | | | | | | | |
| | 220 | | | | | | | |
| | 330 | | | | | | | |
| | 470 | | | | | | | |
| | 680 | | | | | | | |
| | 1000 | | | | | | | |
| | 1500 | | | | | | | |
| | 2200 | | | | | | | |
| | 3300 | | | | | | | |
| | 4700 | | | | | | | |
| | 6800 | | | | | | | |
| Cap (µF) | 0.010 | | | | | | | |
| | 0.015 | | | | | | | |
| | 0.022 | | | | | | | |
| | 0.033 | C | | | | | | |
| | 0.047 | C | | | | | | |
| | 0.068 | C | | | | | | |
| | 0.10 | C | | | | | | |
| | 0.15 | | | | | | | |
| | 0.22 | | | | | | | |
| | 0.33 | | G | | | | | |
| | 0.47 | | G | | | | | |
| | 0.68 | | G | | | | | |
| | 1.0 | E | | | | | | |
| | 1.5 | | | | N | | | |
| | 2.2 | E | | | N | | | |
| | 3.3 | | | | N | | | |
| | 4.7 | | | | N | Q | Q* | |
| | 10 | | | | | | | |
| | 22 | | | | | | | Z |
| | 47 | | | | | | | |
| | 100 | | | | | | | |
| WVDC | 4 | 6.3 | 6.3 | 4 | 10 | 50 | 100 | 6.3 |
| SIZE | 0402 | | 0603 | 0805 | 1206 | | | 1210 |

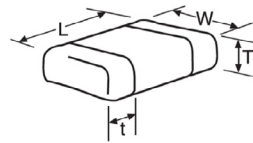

| Letter | A | C | E | G | J | K | M | N | P | Q | X | Y | Z |
|----------------|-----------------|-----------------|-----------------|-----------------|-----------------|-----------------|-----------------|-----------------|-----------------|-----------------|-----------------|-----------------|-----------------|
| Max. Thickness | 0.33 (0.013) | 0.56 (0.022) | 0.71 (0.028) | 0.90 (0.035) | 0.94 (0.037) | 1.02 (0.040) | 1.27 (0.050) | 1.40 (0.055) | 1.52 (0.060) | 1.90 (0.075) | 2.29 (0.090) | 2.54 (0.100) | 2.79 (0.110) |
| | PAPER | | | | | EMBOSSD | | | | | | | |

*Contact Factory for Specifications

X5R Dielectric

General Specifications

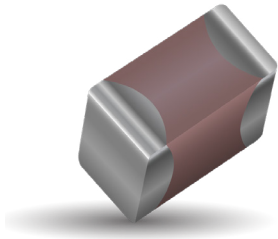

GENERAL DESCRIPTION

- General Purpose Dielectric for Ceramic Capacitors
- EIA Class II Dielectric
- Temperature variation of capacitance is within $\pm 15\%$ from -55°C to $+85^{\circ}\text{C}$
- Well suited for decoupling and filtering applications
- Available in High Capacitance values (up to $100\mu\text{F}$)

PART NUMBER (SEE PAGE 4 FOR COMPLETE PART NUMBER EXPLANATION)

| 1210 | 4 | D | 107 | M | A | T | 2 | A |
|--------------------------|----------------|-------------------|---------------------------------|----------------------------------|---------------------|----------------------|-----------------------------|---------------------|
| Size (L" x W") | Voltage | Dielectric | Capacitance Code (In pF) | Capacitance Tolerance | Failure Rate | Terminations | Packaging | Special Code |
| 0101** | 4 = 4V | D = X5R | 2 Sig. Digits + Number of Zeros | K = $\pm 10\%$ M = $\pm 20\%$ | A = N/A | T = Plated Ni and Sn | 2 = 7" Reel 4 = 13" Reel | A = Std. |
| 0201 | Z = 10V | | | | | | | |
| 0402 | Y = 16V | | | | | | | |
| 0603 | 3 = 25V | | | | | | | |
| 0805 | D = 35V | | | | | | | |
| 1206 | 5 = 50V | | | | | | | |
| 1210 | 1 = 100V | | | | | | | |
| 1812 | | | | | | | | |
| **EIA 01005 | | | | | | | | |



NOTE: Contact factory for availability of Tolerance Options for Specific Part Numbers.
Contact factory for non-specified capacitance values.

TYPICAL ELECTRICAL CHARACTERISTICS

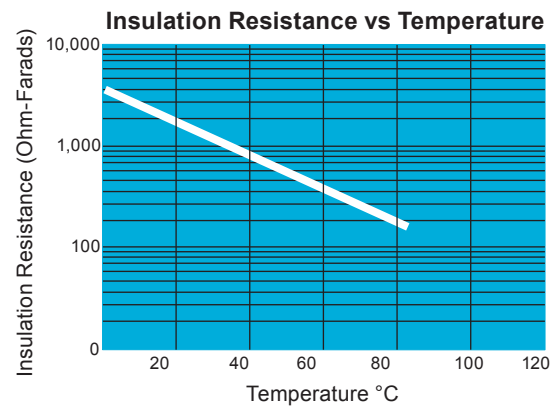
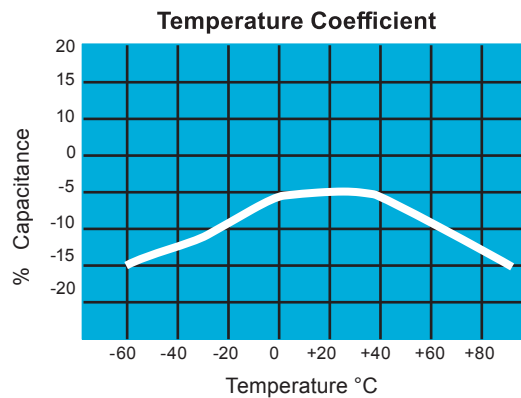

X5R Dielectric

Specifications and Test Methods

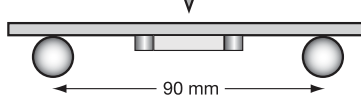
| Parameter/Test | | X5R Specification Limits | Measuring Conditions | |
|--------------------------------|-----------------------|---|---|--------------------|
| Operating Temperature Range | | -55°C to +85°C | Temperature Cycle Chamber | |
| Capacitance | | Within specified tolerance | | |
| Dissipation Factor | | $\leq 2.5\%$ for $\geq 50V$ DC rating $\leq 12.5\%$ for 25V, 35V DC rating $\leq 12.5\%$ Max. for 16V DC rating and lower Contact Factory for DF by PN | Freq.: 1.0 kHz $\pm 10\%$ Voltage: 1.0Vrms $\pm .2V$ For Cap > 10 μF , 0.5Vrms @ 120Hz | |
| Insulation Resistance | | 10,000M Ω or 500M Ω - μF , whichever is less | Charge device with rated voltage for 120 ± 5 secs @ room temp/humidity | |
| Dielectric Strength | | No breakdown or visual defects | Charge device with 250% of rated voltage for 1-5 seconds, w/charge and discharge current limited to 50 mA (max) | |
| Resistance to Flexure Stresses | Appearance | No defects | Deflection: 2mm Test Time: 30 seconds  | |
| | Capacitance Variation | $\leq \pm 12\%$ | | |
| | Dissipation Factor | Meets Initial Values (As Above) | | |
| | Insulation Resistance | \geq Initial Value x 0.3 | | |
| Solderability | | $\geq 95\%$ of each terminal should be covered with fresh solder | Dip device in eutectic solder at 230 $\pm 5^\circ C$ for 5.0 ± 0.5 seconds | |
| Resistance to Solder Heat | Appearance | No defects, <25% leaching of either end terminal | Dip device in eutectic solder at 260°C for 60seconds. Store at room temperature for 24 \pm 2 hours before measuring electrical properties. | |
| | Capacitance Variation | $\leq \pm 7.5\%$ | | |
| | Dissipation Factor | Meets Initial Values (As Above) | | |
| | Insulation Resistance | Meets Initial Values (As Above) | | |
| | Dielectric Strength | Meets Initial Values (As Above) | | |
| Thermal Shock | Appearance | No visual defects | Step 1: -55°C $\pm 2^\circ$ | 30 ± 3 minutes |
| | Capacitance Variation | $\leq \pm 7.5\%$ | Step 2: Room Temp | ≤ 3 minutes |
| | Dissipation Factor | Meets Initial Values (As Above) | Step 3: +85°C $\pm 2^\circ$ | 30 ± 3 minutes |
| | Insulation Resistance | Meets Initial Values (As Above) | Step 4: Room Temp | ≤ 3 minutes |
| | Dielectric Strength | Meets Initial Values (As Above) | Repeat for 5 cycles and measure after 24 ± 2 hours at room temperature | |
| Load Life | Appearance | No visual defects | Charge device with 1.5X rated voltage in test chamber set at 85°C $\pm 2^\circ C$ for 1000 hours (+48, -0). Note: Contact factory for *optional specification part numbers that are tested at < 1.5X rated voltage. Remove from test chamber and stabilize at room temperature for 24 ± 2 hours | |
| | Capacitance Variation | $\leq \pm 12.5\%$ | | |
| | Dissipation Factor | \leq Initial Value x 2.0 (See Above) | | |
| | Insulation Resistance | \geq Initial Value x 0.3 (See Above) | | |
| | Dielectric Strength | Meets Initial Values (As Above) | | |
| Load Humidity | Appearance | No visual defects | Store in a test chamber set at 85°C $\pm 2^\circ C$ / 85% $\pm 5\%$ relative humidity for 1000 hours (+48, -0) with rated voltage applied. Remove from chamber and stabilize at room temperature and humidity for 24 ± 2 hours before measuring. | |
| | Capacitance Variation | $\leq \pm 12.5\%$ | | |
| | Dissipation Factor | \leq Initial Value x 2.0 (See Above) | | |
| | Insulation Resistance | \geq Initial Value x 0.3 (See Above) | | |
| | Dielectric Strength | Meets Initial Values (As Above) | | |

X5R Dielectric

Capacitance Range



PREFERRED SIZES ARE SHADED

| Case Size | 0101* | | 0201 | | | | 0402 | | | | | 0603 | | | | | | 0805 | | | | | |
|-------------------|----------------|---------------------------------|--------------------------------|-------------------|-------------------|----------------------|--------------------------------|----------------------|----------------------|----------------------|----------------------|--------------------------------|----------------------|----------------------|----------------------|----------------------|----------------------|--------------------------------|--|--|--|--|--|
| Soldering | Reflow Only | | Reflow Only | | | | Reflow/Wave | | | | | Reflow/Wfeve | | | | | | Reflow/Wfeve | | | | | |
| Packaging | Paper/Embossed | | All Paper | | | | All Paper | | | | | All Paper | | | | | | Paper/Embossed | | | | | |
| (L) Length | mm | 0.40 ± 0.02 (0.016 ± 0.0008) | 0.60 ± 0.09 (0.024 ± 0.004) | | | | 1.00 ± 0.20 (0.040 ± 0.008) | | | | | 1.60 ± 0.15 (0.063 ± 0.006) | | | | | | 2.01 ± 0.20 (0.079 ± 0.008) | | | | | |
| (W) Width | mm | 0.20 ± 0.02 (0.008 ± 0.0008) | 0.30 ± 0.09 (0.011 ± 0.004) | | | | 0.50 ± 0.20 (0.020 ± 0.008) | | | | | 0.81 ± 0.15 (0.032 ± 0.006) | | | | | | 1.25 ± 0.20 (0.049 ± 0.008) | | | | | |
| (t) Terminal | mm | 0.10 ± 0.04 (0.004 ± 0.0016) | 0.15 ± 0.05 (0.006 ± 0.002) | | | | 0.25 ± 0.15 (0.010 ± 0.006) | | | | | 0.35 ± 0.15 (0.014 ± 0.006) | | | | | | 0.50 ± 0.25 (0.020 ± 0.010) | | | | | |
| Voltage: | | 6.3 10 | 4 6.3 10 16 25 | 4 6.3 10 16 25 50 | 4 6.3 10 16 25 50 | 4 6.3 10 16 25 35 50 | 4 6.3 10 16 25 35 50 | 4 6.3 10 16 25 35 50 | 4 6.3 10 16 25 35 50 | 4 6.3 10 16 25 35 50 | 4 6.3 10 16 25 35 50 | 4 6.3 10 16 25 35 50 | 4 6.3 10 16 25 35 50 | 4 6.3 10 16 25 35 50 | 4 6.3 10 16 25 35 50 | 4 6.3 10 16 25 35 50 | 4 6.3 10 16 25 35 50 | | | | | | |
| Cap (pF) 100 101 | | B | | | | A | | | | | | | | | | | | | | | | | |
| 150 151 | | B | | | | A | | | | | | | | | | | | | | | | | |
| 220 221 | | B | | | | A | | | | | C | | | | | | | | | | | | |
| 330 331 | | B | | | | A | | | | | C | | | | | | | | | | | | |
| 470 471 | | B | | | | A | | | | | C | | | | | | | | | | | | |
| 680 681 | | B | | | | A | | | | | C | | | | | | | | | | | | |
| 1000 102 | | B | | | | A | A | | | | C | | | | | | | | | | | | |
| 1500 152 | B | B | | | | A | A | | | | C | | | | | | | | | | | | |
| 2200 222 | B | B | | | A | A | A | | | | C | | | | | | | | | | | | |
| 3300 332 | B | B | | | A | A | A | | | | C | | | | | | | | | | | | |
| 4700 472 | B | B | | | A | A | A | | | | C | | | | | | | | | | | | |
| 6800 682 | B | B | | | A | A | A | | | | C | | | | | | | | | | | | |
| Cap (µF) 0.01 103 | B | B | | | A | A | A | | | | C | | | | | | | | | | | | |
| 0.015 150 | B | | | | | | | | | | C | | | G | G | G | | | | | | | |
| 0.022 223 | B | | | A | A | A | A | | | | C | C | | G | G | G | | | | | | | |
| 0.033 333 | B | | | | | | | | | | C | | | G | G | G | | | | | | | |
| 0.047 473 | B | | | A | A | A | A | | | | C | C | | G | G | G | | | | | | | |
| 0.068 689 | B | | | | | | | | | | C | | | G | | G | | | | | | | |
| 0.1 104 | B | | | A | A | A | A | | | | C | C | C | C | | G | G | G | | | | | |
| 0.15 154 | | | | | | | | | | | | | | | | G | | | | | | | |
| 0.22 224 | B | | | A | A | A | | | | | C | C | C | C | C | G | | | | | | | |
| 0.33 334 | | | | | | | | | | | | | | | | G | G | | | | | | |
| 0.47 474 | B | | | A | A | | | | | | C | C | C | C | C | E | | | | | | | |
| 0.68 684 | | | | | | | | | | | | | | | | G | | | | | | | |
| 1.0 105 | | | | A | A | C | C | | | | C | C | C | C | C | G | G | G | | | | | |
| 1.5 155 | | | | | | | | | | | | | | | | G | G | J | | | | | |
| 2.2 225 | | | | C | C | C | | | | | C | C | C | C | C | G | G | J | | | | | |
| 3.3 335 | | | | | | | | | | | | | | | | J | J | J | | | | | |
| 4.7 475 | | | | C | C | | | | | | E | E | E | E | | J | J | J | | | | | |
| 10 106 | | | | | | | | | | | E | E | E | | | K | J | K | | | | | |
| 22 226 | | | | | | | | | | | E | G | | | | K | K | K | | | | | |
| 47 476 | | | | | | | | | | | | | | | | K | K | | | | | | |
| 100 107 | | | | | | | | | | | | | | | | K | K | | | | | | |
| Voltage: | | 6.3 10 | 4 6.3 10 16 25 | 4 6.3 10 16 25 50 | 4 6.3 10 16 25 50 | 4 6.3 10 16 25 35 50 | 4 6.3 10 16 25 35 50 | 4 6.3 10 16 25 35 50 | 4 6.3 10 16 25 35 50 | 4 6.3 10 16 25 35 50 | 4 6.3 10 16 25 35 50 | 4 6.3 10 16 25 35 50 | 4 6.3 10 16 25 35 50 | 4 6.3 10 16 25 35 50 | 4 6.3 10 16 25 35 50 | 4 6.3 10 16 25 35 50 | 4 6.3 10 16 25 35 50 | | | | | | |
| Case Size | | 0101* | 0201 | | | | 0402 | | | | | 0603 | | | | | | 0805 | | | | | |

| Letter | A | B | C | E | G | J | K | M | N | P | Q | X | Y | Z | |
|----------------|-----------------|-----------------|-----------------|-----------------|-----------------|-----------------|-----------------|-----------------|-----------------|-----------------|-----------------|-----------------|-----------------|-----------------|--|
| Max. Thickness | 0.33 (0.013) | 0.22 (0.009) | 0.56 (0.022) | 0.71 (0.028) | 0.90 (0.035) | 0.94 (0.037) | 1.02 (0.040) | 1.27 (0.050) | 1.40 (0.055) | 1.52 (0.060) | 1.78 (0.070) | 2.29 (0.090) | 2.54 (0.100) | 2.79 (0.110) | |
| | PAPER | | | | | | EMBOSSSED | | | | | | | | |

PAPER and EMBOSSSED available for 01005
 NOTE: Contact factory for non-specified capacitance values
 *EIA 01005

X5R Dielectric Capacitance Range



PREFERRED SIZES ARE SHADED

| Case Size | | | 1206 | | | | | | | 1210 | | | | | | | 1812 | | | | | | |
|--------------|-------|-------|--------------------------------|-----|----|----|----|----|----|--------------------------------|-----|----|----|----|----|----|--------------------------------|-----|----|----|----|----|----|
| Soldering | | | Reflow/Wave | | | | | | | Reflow Only | | | | | | | Reflow Only | | | | | | |
| Packaging | | | Paper/Embossed | | | | | | | Paper/Embossed | | | | | | | All Embossed | | | | | | |
| (L) Length | mm | (in.) | 3.20 ± 0.40 (0.126 ± 0.016) | | | | | | | 3.20 ± 0.40 (0.126 ± 0.016) | | | | | | | 4.50 ± 0.30 (0.177 ± 0.012) | | | | | | |
| W) Width | mm | (in.) | 1.60 ± 0.30 (0.063 ± 0.012) | | | | | | | 2.50 ± 0.30 (0.098 ± 0.012) | | | | | | | 3.20 ± 0.20 (0.126 ± 0.008) | | | | | | |
| (t) Terminal | mm | (in.) | 0.50 ± 0.25 (0.020 ± 0.010) | | | | | | | 0.50 ± 0.25 (0.020 ± 0.010) | | | | | | | 0.61 ± 0.36 (0.024 ± 0.014) | | | | | | |
| Voltage: | | | 4 | 6.3 | 10 | 16 | 25 | 35 | 50 | 4 | 6.3 | 10 | 16 | 25 | 35 | 50 | 4 | 6.3 | 10 | 16 | 25 | 35 | 50 |
| Cap (pF) | 100 | 101 | | | | | | | | | | | | | | | | | | | | | |
| | 150 | 151 | | | | | | | | | | | | | | | | | | | | | |
| | 220 | 221 | | | | | | | | | | | | | | | | | | | | | |
| | 330 | 331 | | | | | | | | | | | | | | | | | | | | | |
| | 470 | 471 | | | | | | | | | | | | | | | | | | | | | |
| | 680 | 681 | | | | | | | | | | | | | | | | | | | | | |
| | 1000 | 102 | | | | | | | | | | | | | | | | | | | | | |
| | 1500 | 152 | | | | | | | | | | | | | | | | | | | | | |
| | 2200 | 222 | | | | | | | | | | | | | | | | | | | | | |
| | 3300 | 332 | | | | | | | | | | | | | | | | | | | | | |
| | 4700 | 472 | | | | | | | | | | | | | | | | | | | | | |
| | 6800 | 682 | | | | | | | | | | | | | | | | | | | | | |
| Cap (µF) | 0.01 | 103 | | | | | | | | | | | | | | | | | | | | | |
| | 0.015 | 150 | | | | | | | | | | | | | | | | | | | | | |
| | 0.022 | 223 | | | | | | | | | | | | | | | | | | | | | |
| | 0.033 | 333 | | | | | | | | | | | | | | | | | | | | | |
| | 0.047 | 473 | | | | | | | | | | | | | | | | | | | | | |
| | 0.068 | 689 | | | | | | | | | | | | | | | | | | | | | |
| | 0.1 | 104 | | | | | | | | | | | | | | | | | | | | | |
| | 0.15 | 154 | | | | | | | | | | | | | | | | | | | | | |
| | 0.22 | 224 | | | | | | | | | | | | | | | | | | | | | |
| | 0.33 | 334 | | | | | | | | | | | | | | | | | | | | | |
| | 0.47 | 474 | | | | | Q | Q | | | | | | X | X | | | | | | | | |
| | 0.68 | 684 | | | | | | | | | | | | | | | | | | | | | |
| | 1.0 | 105 | | | | | Q | Q | Q | | | | | X | X | X | | | | | | | |
| | 1.5 | 155 | | | | | | | | | | | | X | X | X | | | | | | | |
| | 2.2 | 225 | | | | Q | Q | Q | Q | Q | | | | X | Z | Z | | | | | | | |
| | 3.3 | 335 | | Q | Q | | | | | | | | | | | | | | | | | | |
| | 4.7 | 475 | X | X | X | X | X | X | X | | | Z | Z | Z | Z | Z | | | | | | | |
| | 10 | 106 | X | X | X | X | X | X | X | | X | X | Z | Z | Z | Z | | | | | Z | | |
| | 22 | 226 | X | X | X | X | X | | | | Z | Z | Z | Z | Z | | | Z | Z | Z | Z | | |
| | 47 | 476 | X | X | X | X | | | | | Z | Z | Z | Z | Z | | | | | | | | |
| | 100 | 107 | X | X | | | | | | | Z | Z | | | | | | | | | | | |
| Voltage: | | | 4 | 6.3 | 10 | 16 | 25 | 35 | 50 | 4 | 6.3 | 10 | 16 | 25 | 35 | 50 | 4 | 6.3 | 10 | 16 | 25 | 35 | 50 |
| Case Size | | | 1206 | | | | | | | 1210 | | | | | | | 1812 | | | | | | |

| Letter | A | B | C | E | G | J | K | M | N | P | Q | X | Y | Z |
|----------------|-----------------|-----------------|-----------------|-----------------|-----------------|-----------------|-----------------|-----------------|-----------------|-----------------|-----------------|-----------------|-----------------|-----------------|
| Max. Thickness | 0.33 (0.013) | 0.22 (0.009) | 0.56 (0.022) | 0.71 (0.028) | 0.90 (0.035) | 0.94 (0.037) | 1.02 (0.040) | 1.27 (0.050) | 1.40 (0.055) | 1.52 (0.060) | 1.78 (0.070) | 2.29 (0.090) | 2.54 (0.100) | 2.79 (0.110) |
| | PAPER | | | | | | EMBOSSSED | | | | | | | |

PAPER and EMBOSSSED available for 01005

NOTE: Contact factory for non-specified capacitance values
*EIA 01005



The Important Information/Disclaimer is incorporated in the catalog where these specifications came from or available online at www.avx.com/disclaimer/ by reference and should be reviewed in full before placing any order.

Y5V Dielectric

General Specifications

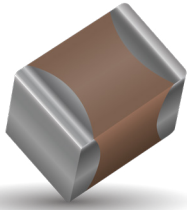

GENERAL DESCRIPTION

Y5V formulations are for general-purpose use in a limited temperature range. They have a wide temperature characteristic of +22% –82% capacitance change over the operating temperature range of –30°C to +85°C. These characteristics make Y5V ideal for decoupling applications within limited temperature range.



PART NUMBER (SEE PAGE 4 FOR COMPLETE PART NUMBER EXPLANATION)

0805
Size
(L" x W")

3
Voltage
6.3V = 6
10V = Z
16V = Y
25V = 3
50V = 5

G
Dielectric
Y5V = G

104
Capacitance Code (In pF)
2 Sig. Digits + Number of Zeros

Z
Capacitance Tolerance
Z = +80 –20%

A
Failure Rate
A = Not Applicable

T
Terminations
T = Plated Ni and Sn

2
Packaging
2 = 7" Reel
4 = 13" Reel

A
Special Code
A = Std. Product

Temperature Coefficient

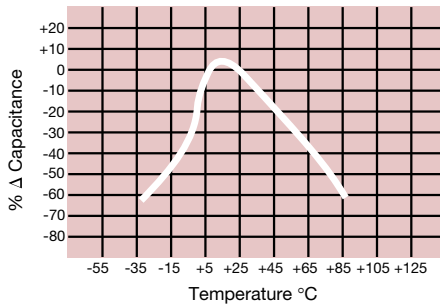

Capacitance Change vs. DC Bias Voltage

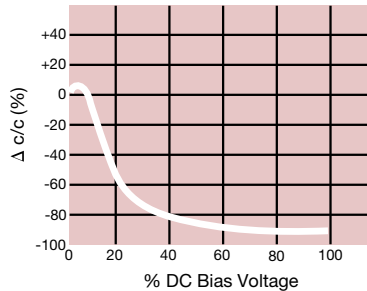

Insulation Resistance vs. Temperature

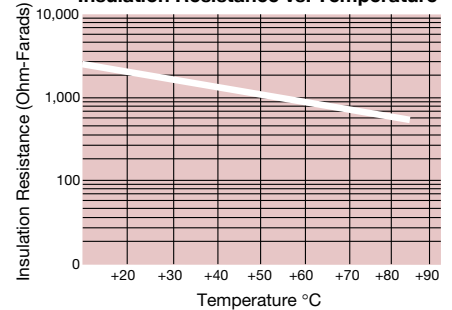

0.1 μF - 0603 Impedance vs. Frequency

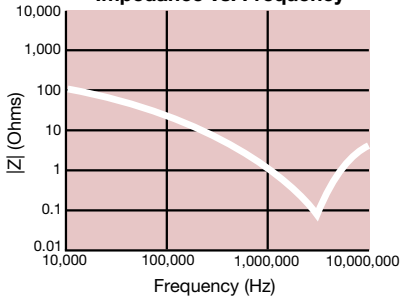

0.22 μF - 0805 Impedance vs. Frequency

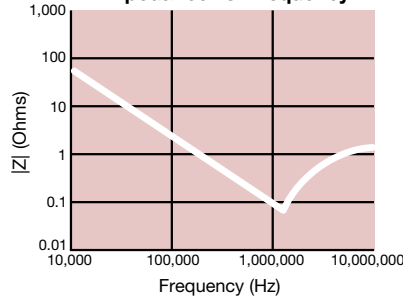

1 μF - 1206 Impedance vs. Frequency

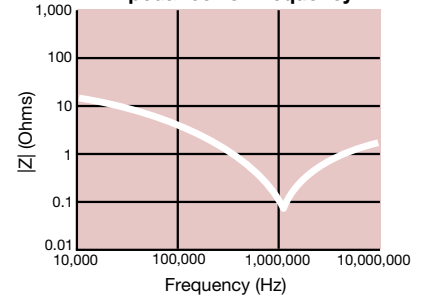

Y5V Dielectric

Specifications and Test Methods

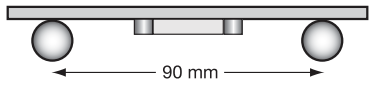
| Parameter/Test | | Y5V Specification Limits | Measuring Conditions | |
|--------------------------------|-----------------------|---|---|----------------|
| Operating Temperature Range | | -30°C to +85°C | Temperature Cycle Chamber | |
| Capacitance | | Within specified tolerance | Freq.: 1.0 kHz ± 10% Voltage: 1.0Vrms ± .2V For Cap > 10 µF, 0.5Vrms @ 120Hz | |
| Dissipation Factor | | ≤ 5.0% for ≥ 50V DC rating ≤ 7.0% for 25V DC rating ≤ 9.0% for 16V DC rating ≤ 12.5% for ≤ 10V DC rating | | |
| Insulation Resistance | | 10,000MΩ or 500MΩ - µF, whichever is less | | |
| Dielectric Strength | | No breakdown or visual defects | Charge device with 250% of rated voltage for 1-5 seconds, w/charge and discharge current limited to 50 mA (max) | |
| Resistance to Flexure Stresses | Appearance | No defects | Deflection: 2mm Test Time: 30 seconds 1mm/sec  | |
| | Capacitance Variation | ≤ ±30% | | |
| | Dissipation Factor | Meets Initial Values (As Above) | | |
| | Insulation Resistance | ≥ Initial Value x 0.1 | | |
| Solderability | | ≥ 95% of each terminal should be covered with fresh solder | Dip device in eutectic solder at 230 ± 5°C for 5.0 ± 0.5 seconds | |
| Resistance to Solder Heat | Appearance | No defects, <25% leaching of either end terminal | Dip device in eutectic solder at 260°C for 60 seconds. Store at room temperature for 24 ± 2 hours before measuring electrical properties. | |
| | Capacitance Variation | ≤ ±20% | | |
| | Dissipation Factor | Meets Initial Values (As Above) | | |
| | Insulation Resistance | Meets Initial Values (As Above) | | |
| | Dielectric Strength | Meets Initial Values (As Above) | | |
| Thermal Shock | Appearance | No visual defects | Step 1: -30°C ± 2° | 30 ± 3 minutes |
| | Capacitance Variation | ≤ ±20% | Step 2: Room Temp | ≤ 3 minutes |
| | Dissipation Factor | Meets Initial Values (As Above) | Step 3: +85°C ± 2° | 30 ± 3 minutes |
| | Insulation Resistance | Meets Initial Values (As Above) | Step 4: Room Temp | ≤ 3 minutes |
| | Dielectric Strength | Meets Initial Values (As Above) | Repeat for 5 cycles and measure after 24 ± 2 hours at room temperature | |
| Load Life | Appearance | No visual defects | Charge device with twice rated voltage in test chamber set at 85°C ± 2°C for 1000 hours (+48, -0) Remove from test chamber and stabilize at room temperature for 24 ± 2 hours before measuring. | |
| | Capacitance Variation | ≤ ±30% | | |
| | Dissipation Factor | ≤ Initial Value x 1.5 (See Above) | | |
| | Insulation Resistance | ≥ Initial Value x 0.1 (See Above) | | |
| | Dielectric Strength | Meets Initial Values (As Above) | | |
| Load Humidity | Appearance | No visual defects | Store in a test chamber set at 85°C ± 2°C/ 85% ± 5% relative humidity for 1000 hours (+48, -0) with rated voltage applied. Remove from chamber and stabilize at room temperature and humidity for 24 ± 2 hours before measuring. | |
| | Capacitance Variation | ≤ ±30% | | |
| | Dissipation Factor | ≤ Initial Value x 1.5 (See above) | | |
| | Insulation Resistance | ≥ Initial Value x 0.1 (See Above) | | |
| | Dielectric Strength | Meets Initial Values (As Above) | | |

Y5V Dielectric Capacitance Range

PREFERRED SIZES ARE SHADED

| SIZE | 0201 | | | | 0402 | | | | 0603 | | | | 0805 | | | | 1206 | | | | 1210 | | | | | | |
|--------------|-------------|----|-----------------|----|-------------|----|-----------------|----|-------------|----|-----------------|----|----------------|----|-----------------|----|----------------|----|-----------------|----|----------------|----|-----------------|----|----|----|----|
| Soldering | Reflow Only | | | | Reflow/Wave | | | | Reflow/Wave | | | | Reflow/Wave | | | | Reflow/Wave | | | | Reflow/Wave | | | | | | |
| Packaging | All Paper | | | | All Paper | | | | All Paper | | | | Paper/Embossed | | | | Paper/Embossed | | | | Paper/Embossed | | | | | | |
| (L) Length | mm | | (0.60 ± 0.09) | | mm | | (1.00 ± 0.10) | | mm | | (1.60 ± 0.15) | | mm | | (2.01 ± 0.20) | | mm | | (3.20 ± 0.20) | | mm | | (3.20 ± 0.20) | | | | |
| (L) Length | (in.) | | (0.024 ± 0.004) | | (in.) | | (0.040 ± 0.004) | | (in.) | | (0.063 ± 0.006) | | (in.) | | (0.079 ± 0.008) | | (in.) | | (0.126 ± 0.008) | | (in.) | | (0.126 ± 0.008) | | | | |
| (W) Width | mm | | (0.30 ± 0.09) | | mm | | (0.50 ± 0.10) | | mm | | (.81 ± 0.15) | | mm | | (1.25 ± 0.20) | | mm | | (1.60 ± 0.20) | | mm | | (2.50 ± 0.20) | | | | |
| (W) Width | (in.) | | (0.011 ± 0.004) | | (in.) | | (0.020 ± 0.004) | | (in.) | | (0.032 ± 0.006) | | (in.) | | (0.049 ± 0.008) | | (in.) | | (0.063 ± 0.008) | | (in.) | | (0.098 ± 0.008) | | | | |
| (t) Terminal | mm | | (0.15 ± 0.05) | | mm | | (0.25 ± 0.15) | | mm | | (0.35 ± 0.15) | | mm | | (0.50 ± 0.25) | | mm | | (0.50 ± 0.25) | | mm | | (0.50 ± 0.25) | | | | |
| (t) Terminal | (in.) | | (0.006 ± 0.002) | | (in.) | | (0.010 ± 0.006) | | (in.) | | (0.014 ± 0.006) | | (in.) | | (0.020 ± 0.010) | | (in.) | | (0.020 ± 0.010) | | (in.) | | (0.020 ± 0.010) | | | | |
| WVDC | 6.3 | 10 | 6 | 10 | 16 | 25 | 50 | 10 | 16 | 25 | 50 | 10 | 16 | 25 | 50 | 10 | 16 | 25 | 50 | 10 | 16 | 25 | 50 | | | | |
| Cap (pF) | 820 | | A | | | | | | | | | | | | | | | | | | | | | | | | |
| Cap (pF) | 1000 | | A | | | | | | | | | | | | | | | | | | | | | | | | |
| Cap (pF) | 2200 | | A | | | | | | | | | | | | | | | | | | | | | | | | |
| Cap (pF) | 4700 | | A | | | | | | | | | | | | | | | | | | | | | | | | |
| Cap (μF) | 0.010 | A | A | | | | | | | | | | | | | | | | | | | | | | | | |
| Cap (μF) | 0.022 | A | | | | | | | | | | | | | | | | | | | | | | | | | |
| Cap (μF) | 0.047 | A | | | | | | | | | | | | | | | | | | | | | | | | | |
| Cap (μF) | 0.10 | | | | C | C | | | | | | G | G | | | | | | | | | | | | | | |
| Cap (μF) | 0.22 | | | | | | | | | | | G | | | | | | | | | | | | | | | |
| Cap (μF) | 0.33 | | | | | | | | | | | G | | | | | | | | | | | | | | | |
| Cap (μF) | 0.47 | | | | | | | | | | | G | G | | | | | | | | | | | | | | |
| Cap (μF) | 1.0 | | | | C | C | | | | | | G | G | J | | | | | | | | | | N | | | |
| Cap (μF) | 2.2 | | | | | | | | | | | J | | | | | | | | | | | | | | | |
| Cap (μF) | 4.7 | | | | | | | | | | | | | | | | | | | | | | | | | | |
| Cap (μF) | 10.0 | | | | | | | | | | | | | | | | | | | | | | | | | | |
| Cap (μF) | 22.0 | | | | | | | | | | | | | | | | | | | | | | | | | | |
| Cap (μF) | 47.0 | | | | | | | | | | | | | | | | | | | | | | | | | | |
| WVDC | 6.3 | 10 | 6 | 10 | 16 | 25 | 50 | 10 | 16 | 25 | 50 | 10 | 16 | 25 | 50 | 10 | 16 | 25 | 50 | 10 | 16 | 25 | 50 | 10 | 16 | 25 | 50 |
| SIZE | 0201 | | | | 0402 | | | | 0603 | | | | 0805 | | | | 1206 | | | | 1210 | | | | | | |

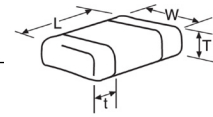

| Letter | A | C | E | G | J | K | M | N | P | Q | X | Y | Z |
|-----------|---------|---------|---------|---------|---------|---------|---------|---------|---------|---------|---------|---------|---------|
| Max. | 0.33 | 0.56 | 0.71 | 0.90 | 0.94 | 1.02 | 1.27 | 1.40 | 1.52 | 1.78 | 2.29 | 2.54 | 2.79 |
| Thickness | (0.013) | (0.022) | (0.028) | (0.035) | (0.037) | (0.040) | (0.050) | (0.055) | (0.060) | (0.070) | (0.090) | (0.100) | (0.110) |
| | PAPER | | | | | EMBOSS | | | | | | | |

MLCC Gold Termination – AU Series

General Specifications

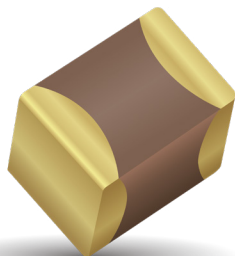

AVX Corporation will support those customers for commercial and military Multilayer Ceramic Capacitors with a termination consisting of Gold. This termination is indicated by the use of a "7" or "G" in the 12th position of the AVX Catalog Part Number. This fulfills AVX's commitment to providing a full range of products to our customers. Please contact the factory if you require additional information on our MLCC Gold Termination.

PART NUMBER

| | | | | | | | | |
|---|---|-------------------------------------|---------------------------------------|---|-----------------------|--|---|---------------------|
| AU03 | Y | G | 104 | K | A | 7 | 2 | A |
| | | | | | | | | |
| Size | Voltage | Dielectric | Capacitance Code (In pF) | Capacitance Tolerance | Failure Rate | Terminations | Packaging | Special Code |
| AU02 - 0402 AU03 - 0603 AU05 - 0805 AU06 - 1206 AU10 - 1210 AU12 - 1812 AU13 - 1825 AU14 - 2225 AU16 - 0306 AU17 - 0508 AU18 - 0612 | 6.3V = 6 10V = Z 16V = Y 25V = 3 35V = D 50V = 5 100V = 1 200V = 2 500V = 7 | C0G (NP0) = A X7R = C X5R = D | 2 Sig. Digits + Number of Zeros | B = ±10 pF (<10pF) C = ±25 pF (<10pF) D = ±50 pF (<10pF) F = ±1% (≥ 10 pF) G = ±2% (≥ 10 pF) J = ±5% K = ±10% M = ±20% | A = Not Applicable | G* = 1.9 μ" to 7.87 μ" 7 = 100 μ" minimum | 2 = 7" Reel 4 = 13" Reel U = 4mm TR (01005) Contact Factory For Multiples* | A = Std. Product |

* Contact factory for availability.

MLCC Gold Termination – AU Series

Capacitance Range (NP0 Dielectric)

PREFERRED SIZES ARE SHADED

| SIZE | AU02 | | | AU03 | | | | AU05 | | | | | AU06 | | | | | | |
|--------------|-----------------------------|-----------------|----|-----------------------------|------|----|----|-----------------------------|------|----|----|-----|-----------------------------|------|----|----|-----|-----|-----|
| Soldering | Reflow/Epoxy/ Wire Bond* | | | Reflow/Epoxy/ Wire Bond* | | | | Reflow/Epoxy/ Wire Bond* | | | | | Reflow/Epoxy/ Wire Bond* | | | | | | |
| Packaging | All Paper | | | All Paper | | | | Paper/Embossed | | | | | Paper/Embossed | | | | | | |
| (L) Length | mm | 1.00 ± 0.10 | | 1.60 ± 0.15 | | | | 2.01 ± 0.20 | | | | | 3.20 ± 0.20 | | | | | | |
| | (in.) | (0.040 ± 0.004) | | (0.063 ± 0.006) | | | | (0.079 ± 0.008) | | | | | (0.126 ± 0.008) | | | | | | |
| (W) Width | mm | 0.50 ± 0.10 | | 0.81 ± 0.15 | | | | 1.25 ± 0.20 | | | | | 1.60 ± 0.20 | | | | | | |
| | (in.) | (0.020 ± 0.004) | | (0.032 ± 0.006) | | | | (0.049 ± 0.008) | | | | | (0.063 ± 0.008) | | | | | | |
| (t) Terminal | mm | 0.25 ± 0.15 | | 0.35 ± 0.15 | | | | 0.50 ± 0.25 | | | | | 0.50 ± 0.25 | | | | | | |
| | (in.) | (0.010 ± 0.006) | | (0.014 ± 0.006) | | | | (0.020 ± 0.010) | | | | | (0.020 ± 0.010) | | | | | | |
| WVDC | | 16 | 25 | 50 | 16 | 25 | 50 | 100 | 16 | 25 | 50 | 100 | 200 | 16 | 25 | 50 | 100 | 200 | 500 |
| Cap (pF) | 0.5 | C | C | C | G | G | G | G | J | J | J | J | J | J | J | J | J | J | J |
| | 1.0 | C | C | C | G | G | G | G | J | J | J | J | J | J | J | J | J | J | J |
| | 1.2 | C | C | C | G | G | G | G | J | J | J | J | J | J | J | J | J | J | J |
| | 1.5 | C | C | C | G | G | G | G | J | J | J | J | J | J | J | J | J | J | J |
| | 1.8 | C | C | C | G | G | G | G | J | J | J | J | J | J | J | J | J | J | J |
| | 2.2 | C | C | C | G | G | G | G | J | J | J | J | J | J | J | J | J | J | J |
| | 2.7 | C | C | C | G | G | G | G | J | J | J | J | J | J | J | J | J | J | J |
| | 3.3 | C | C | C | G | G | G | G | J | J | J | J | J | J | J | J | J | J | J |
| | 3.9 | C | C | C | G | G | G | G | J | J | J | J | J | J | J | J | J | J | J |
| | 4.7 | C | C | C | G | G | G | G | J | J | J | J | J | J | J | J | J | J | J |
| | 5.6 | C | C | C | G | G | G | G | J | J | J | J | J | J | J | J | J | J | J |
| | 6.8 | C | C | C | G | G | G | G | J | J | J | J | J | J | J | J | J | J | J |
| | 8.2 | C | C | C | G | G | G | G | J | J | J | J | J | J | J | J | J | J | J |
| | 10 | C | C | C | G | G | G | G | J | J | J | J | J | J | J | J | J | J | J |
| | 12 | C | C | C | G | G | G | G | J | J | J | J | J | J | J | J | J | J | J |
| | 15 | C | C | C | G | G | G | G | J | J | J | J | J | J | J | J | J | J | J |
| | 18 | C | C | C | G | G | G | G | J | J | J | J | J | J | J | J | J | J | J |
| | 22 | C | C | C | G | G | G | G | J | J | J | J | J | J | J | J | J | J | J |
| | 27 | C | C | C | G | G | G | G | J | J | J | J | J | J | J | J | J | J | J |
| | 33 | C | C | C | G | G | G | G | J | J | J | J | J | J | J | J | J | J | J |
| | 39 | C | C | C | G | G | G | G | J | J | J | J | J | J | J | J | J | J | J |
| | 47 | C | C | C | G | G | G | G | J | J | J | J | J | J | J | J | J | J | J |
| | 56 | C | C | C | G | G | G | G | J | J | J | J | J | J | J | J | J | J | J |
| | 68 | C | C | C | G | G | G | G | J | J | J | J | J | J | J | J | J | J | J |
| | 82 | C | C | C | G | G | G | G | J | J | J | J | J | J | J | J | J | J | J |
| | 100 | C | C | C | G | G | G | G | J | J | J | J | J | J | J | J | J | J | J |
| | 120 | C | C | C | G | G | G | G | J | J | J | J | J | J | J | J | J | J | J |
| | 150 | C | C | C | G | G | G | G | J | J | J | J | J | J | J | J | J | J | J |
| | 180 | C | C | C | G | G | G | G | J | J | J | J | J | J | J | J | J | J | J |
| | 220 | C | C | C | G | G | G | G | J | J | J | J | J | J | J | J | J | J | M |
| | 270 | C | C | C | G | G | G | G | J | J | J | J | M | J | J | J | J | J | M |
| | 330 | C | C | C | G | G | G | G | J | J | J | J | M | J | J | J | J | J | M |
| | 390 | C | C | C | G | G | G | G | J | J | J | J | M | J | J | J | J | J | M |
| | 470 | C | C | C | G | G | G | G | J | J | J | J | M | J | J | J | J | J | M |
| | 560 | | | | G | G | G | G | J | J | J | J | M | J | J | J | J | J | M |
| | 680 | | | | G | G | G | G | J | J | J | J | M | J | J | J | J | J | P |
| | 820 | | | | G | G | G | G | J | J | J | J | M | J | J | J | J | J | M |
| | 1000 | | | | G | G | G | G | J | J | J | J | M | J | J | J | J | J | Q |
| | 1200 | | | | | | | | J | J | J | J | | J | J | J | J | J | Q |
| | 1500 | | | | | | | | J | J | J | J | | J | J | J | J | J | Q |
| | 1800 | | | | | | | | J | J | J | | | J | J | M | M | | |
| | 2200 | | | | | | | | J | J | J | N | | J | J | M | P | | |
| | 2700 | | | | | | | | J | J | J | N | | J | J | M | P | | |
| | 3300 | | | | | | | | J | J | | | | J | J | M | P | | |
| | 3900 | | | | | | | | J | J | | | | J | J | M | P | | |
| | 4700 | | | | | | | | J | J | | | | J | J | M | P | | |
| | 5600 | | | | | | | | | | | | | J | J | M | | | |
| | 6800 | | | | | | | | | | | | | M | M | | | | |
| | 8200 | | | | | | | | | | | | | M | M | | | | |
| | 0.010 | | | | | | | | | | | | | M | M | | | | |
| | 0.012 | | | | | | | | | | | | | | | | | | |
| | 0.015 | | | | | | | | | | | | | | | | | | |
| | 0.018 | | | | | | | | | | | | | | | | | | |
| | 0.022 | | | | | | | | | | | | | | | | | | |
| | 0.027 | | | | | | | | | | | | | | | | | | |
| | 0.033 | | | | | | | | | | | | | | | | | | |
| | 0.039 | | | | | | | | | | | | | | | | | | |
| | 0.047 | | | | | | | | | | | | | | | | | | |
| | 0.068 | | | | | | | | | | | | | | | | | | |
| | 0.082 | | | | | | | | | | | | | | | | | | |
| | 0.1 | | | | | | | | | | | | | | | | | | |
| WVDC | | 16 | 25 | 50 | 16 | 25 | 50 | 100 | 16 | 25 | 50 | 100 | 200 | 16 | 25 | 50 | 100 | 200 | 500 |
| SIZE | | AU02 | | | AU03 | | | | AU05 | | | | | AU06 | | | | | |

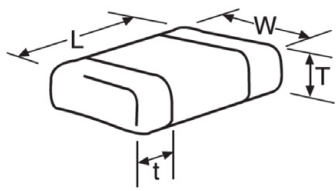

* Contact Factory

| Letter | A | C | E | G | J | K | M | N | P | Q | X | Y | Z |
|----------------|-----------------|-----------------|-----------------|-----------------|-----------------|-----------------|-----------------|-----------------|-----------------|-----------------|-----------------|-----------------|-----------------|
| Max. Thickness | 0.33 (0.013) | 0.56 (0.022) | 0.71 (0.028) | 0.90 (0.035) | 0.94 (0.037) | 1.02 (0.040) | 1.27 (0.050) | 1.40 (0.055) | 1.52 (0.060) | 1.78 (0.070) | 2.29 (0.090) | 2.54 (0.100) | 2.79 (0.110) |
| | PAPER | | | | | EMBOSS | | | | | | | |

MLCC Gold Termination – AU Series

Capacitance Range (NP0 Dielectric)

PREFERRED SIZES ARE SHADED

| SIZE | | AU10 | | | | | AU12 | | | | | AU13 | | | AU14 | | |
|--------------|-------|-----------------------------|----|-----|-----|-----|-----------------------------|----|-----|-----|-----|-----------------------------|-----|-----|-----------------------------|-----|-----|
| Soldering | | Reflow/Epoxy/ Wire Bond* | | | | | Reflow/Epoxy/ Wire Bond* | | | | | Reflow/Epoxy/ Wire Bond* | | | Reflow/Epoxy/ Wire Bond* | | |
| Packaging | | Paper/Embossed | | | | | All Embossed | | | | | All Embossed | | | All Embossed | | |
| (L) Length | mm | 3.20 ± 0.20 | | | | | 4.50 ± 0.30 | | | | | 4.50 ± 0.30 | | | 5.72 ± 0.25 | | |
| | (in.) | (0.126 ± 0.008) | | | | | (0.177 ± 0.012) | | | | | (0.177 ± 0.012) | | | (0.225 ± 0.010) | | |
| W) Width | mm | 2.50 ± 0.20 | | | | | 3.20 ± 0.20 | | | | | 6.40 ± 0.40 | | | 6.35 ± 0.25 | | |
| | (in.) | (0.098 ± 0.008) | | | | | (0.126 ± 0.008) | | | | | (0.252 ± 0.016) | | | (0.250 ± 0.010) | | |
| (t) Terminal | mm | 0.50 ± 0.25 | | | | | 0.61 ± 0.36 | | | | | 0.61 ± 0.36 | | | 0.64 ± 0.39 | | |
| | (in.) | (0.020 ± 0.010) | | | | | (0.024 ± 0.014) | | | | | (0.024 ± 0.014) | | | (0.025 ± 0.015) | | |
| WVDC | | 25 | 50 | 100 | 200 | 500 | 25 | 50 | 100 | 200 | 500 | 50 | 100 | 200 | 50 | 100 | 200 |
| Cap (pF) | 0.5 | | | | | | | | | | | | | | | | |
| | 1.0 | | | | | | | | | | | | | | | | |
| | 1.2 | | | | | | | | | | | | | | | | |
| | 1.5 | | | | | | | | | | | | | | | | |
| | 1.8 | | | | | | | | | | | | | | | | |
| | 2.2 | | | | | | | | | | | | | | | | |
| | 2.7 | | | | | | | | | | | | | | | | |
| | 3.3 | | | | | | | | | | | | | | | | |
| | 3.9 | | | | | | | | | | | | | | | | |
| | 4.7 | | | | | | | | | | | | | | | | |
| 5.6 | | | | | | | | | | | | | | | | | |
| 6.8 | | | | | | | | | | | | | | | | | |
| 8.2 | | | | | | | | | | | | | | | | | |
| 10 | | | | | | J | | | | | | | | | | | |
| 12 | | | | | | J | | | | | | | | | | | |
| 15 | | | | | | J | | | | | | | | | | | |
| 18 | | | | | | J | | | | | | | | | | | |
| 22 | | | | | | J | | | | | | | | | | | |
| 27 | | | | | | J | | | | | | | | | | | |
| 33 | | | | | | J | | | | | | | | | | | |
| 39 | | | | | | J | | | | | | | | | | | |
| 47 | | | | | | J | | | | | | | | | | | |
| 56 | | | | | | J | | | | | | | | | | | |
| 68 | | | | | | J | | | | | | | | | | | |
| 82 | | | | | | J | | | | | | | | | | | |
| 100 | | | | | | J | | | | | | | | | | | |
| 120 | | | | | | J | | | | | | | | | | | |
| 150 | | | | | | J | | | | | | | | | | | |
| 180 | | | | | | J | | | | | | | | | | | |
| 220 | | | | | | J | | | | | | | | | | | |
| 270 | | | | | | J | | | | | | | | | | | |
| 330 | | | | | | J | | | | | | | | | | | |
| 390 | | | | | | M | | | | | | | | | | | |
| 470 | | | | | | M | | | | | | | | | | | |
| 560 | J | J | J | J | J | | | | | | | | | | | | |
| 680 | J | J | J | J | J | | | | | | | | | | | | |
| 820 | J | J | J | J | J | | | | | | | | | | | | |
| 1000 | J | J | J | J | M | K | K | K | K | M | M | M | M | M | M | P | |
| 1200 | J | J | J | M | M | K | K | K | K | M | M | M | M | M | M | P | |
| 1500 | J | J | J | M | M | K | K | K | K | M | M | M | M | M | M | P | |
| 1800 | J | J | J | M | | K | K | K | K | M | M | M | M | M | M | P | |
| 2200 | J | J | J | Q | | K | K | K | K | P | M | M | M | M | M | P | |
| 2700 | J | J | J | Q | | K | K | K | K | Q | M | M | M | M | M | P | |
| 3300 | J | J | J | | | K | K | K | P | Q | M | M | M | M | M | P | |
| 3900 | J | J | M | | | K | K | K | P | Q | M | M | M | M | M | P | |
| 4700 | J | J | M | | | K | K | K | P | Q | M | M | M | M | M | P | |
| 5600 | J | J | | | | K | K | M | P | X | M | M | M | M | M | P | |
| 6800 | J | J | | | | K | K | M | X | | M | M | M | M | M | P | |
| 8200 | J | J | | | | K | M | M | | | M | M | M | M | M | P | |
| 0.010 | J | J | | | | K | M | M | | | M | M | | M | M | P | |
| 0.012 | J | J | | | | K | M | | | | M | M | | M | M | P | |
| 0.015 | | | | | | M | M | | | | M | M | | M | M | Y | |
| 0.018 | | | | | | M | M | | | | P | M | | M | M | Y | |
| 0.022 | | | | | | M | M | | | | P | | | M | Y | Y | |
| 0.027 | | | | | | M | M | | | | P | | | P | Y | Y | |
| 0.033 | | | | | | M | M | | | | P | | | P | | | |
| 0.039 | | | | | | M | M | | | | P | | | P | | | |
| 0.047 | | | | | | M | M | | | | P | | | P | | | |
| 0.068 | | | | | | M | M | | | | | | | P | | | |
| 0.082 | | | | | | M | M | | | | | | | Q | | | |
| 0.1 | | | | | | | | | | | | | | Q | | | |
| WVDC | | 25 | 50 | 100 | 200 | 500 | 25 | 50 | 100 | 200 | 500 | 50 | 100 | 200 | 50 | 100 | 200 |
| SIZE | | AU10 | | | | | AU12 | | | | | AU13 | | | AU14 | | |

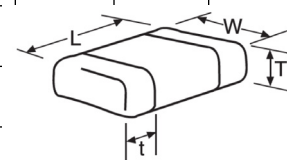

* Contact Factory

| Letter | A | C | E | G | J | K | M | N | P | Q | X | Y | Z |
|----------------|-----------------|-----------------|-----------------|-----------------|-----------------|-----------------|-----------------|-----------------|-----------------|-----------------|-----------------|-----------------|-----------------|
| Max. Thickness | 0.33 (0.013) | 0.56 (0.022) | 0.71 (0.028) | 0.90 (0.035) | 0.94 (0.037) | 1.02 (0.040) | 1.27 (0.050) | 1.40 (0.055) | 1.52 (0.060) | 1.78 (0.070) | 2.29 (0.090) | 2.54 (0.100) | 2.79 (0.110) |
| | PAPER | | | | | EMBOSSED | | | | | | | |

MLCC Gold Termination – AU Series

Capacitance Range (X7R Dielectric)



PREFERRED SIZES ARE SHADED

| SIZE | | AU02 | | | | | AU03 | | | | | AU05 | | | | | AU06 | | | | | | | | | | |
|--------------|-------|-----------------------------|----|----|----|----|-----------------------------|----|----|----|-----|-----------------------------|----|----|----|----|-----------------------------|-----|-----|----|----|----|----|----|-----|-----|-----|
| Soldering | | Reflow/Epoxy/ Wire Bond* | | | | | Reflow/Epoxy/ Wire Bond* | | | | | Reflow/Epoxy/ Wire Bond* | | | | | Reflow/Epoxy/ Wire Bond* | | | | | | | | | | |
| Packaging | | All Paper | | | | | All Paper | | | | | Paper/Embossed | | | | | Paper/Embossed | | | | | | | | | | |
| (L) Length | mm | 1.00 ± 0.10 | | | | | 1.60 ± 0.15 | | | | | 2.01 ± 0.20 | | | | | 3.20 ± 0.20 | | | | | | | | | | |
| | (in.) | (0.040 ± 0.004) | | | | | (0.063 ± 0.006) | | | | | (0.079 ± 0.008) | | | | | (0.126 ± 0.008) | | | | | | | | | | |
| W) Width | mm | 0.50 ± 0.10 | | | | | 0.81 ± 0.15 | | | | | 1.25 ± 0.20 | | | | | 1.60 ± 0.20 | | | | | | | | | | |
| | (in.) | (0.020 ± 0.004) | | | | | (0.032 ± 0.006) | | | | | (0.049 ± 0.008) | | | | | (0.063 ± 0.008) | | | | | | | | | | |
| (t) Terminal | mm | 0.25 ± 0.15 | | | | | 0.35 ± 0.15 | | | | | 0.50 ± 0.25 | | | | | 0.50 ± 0.25 | | | | | | | | | | |
| | (in.) | (0.010 ± 0.006) | | | | | (0.014 ± 0.006) | | | | | (0.020 ± 0.010) | | | | | (0.020 ± 0.010) | | | | | | | | | | |
| WVDC | | 10 | 16 | 25 | 50 | 63 | 10 | 16 | 25 | 50 | 100 | 200 | 63 | 10 | 16 | 25 | 50 | 100 | 200 | 63 | 10 | 16 | 25 | 50 | 100 | 200 | 500 |
| Cap (pF) | 100 | | | | | | | | | | | | | | | | | | | | | | | | | | |
| | 150 | | | | | | | | | | | | | | | | | | | | | | | | | | |
| | 220 | | | | C | | | | G | | | | | | | | | | | | | | | | | | |
| | 330 | | | | C | | | | | G | G | G | | J | J | J | J | J | J | | | | | | | | K |
| 470 | | | | C | | | | | | G | G | G | | J | J | J | J | J | J | | | | | | | K | |
| 680 | | | | C | | | | | | G | G | G | | J | J | J | J | J | J | | | | | | | K | |
| 1000 | | | | C | | | | | | G | G | G | | J | J | J | J | J | J | | | | | | | K | |
| 1500 | | | | C | | | | | | G | G | | | J | J | J | J | J | J | | J | J | J | J | J | M | |
| 2200 | | | | C | | | | | | G | G | | | J | J | J | J | J | J | | J | J | J | J | J | M | |
| 3300 | | | | C | C | | | | | G | G | | | J | J | J | J | J | J | | J | J | J | J | J | M | |
| 4700 | | | | C | C | | | | | G | G | | | J | J | J | J | J | J | | J | J | J | J | J | M | |
| 6800 | | | C | C | | | | | | G | G | | | J | J | J | J | J | J | | J | J | J | J | J | P | |
| Cap (µF) | 0.010 | | | C | | | | | G | | G | G | | J | J | J | J | J | J | | J | J | J | J | J | P | |
| | 0.015 | | | C | | | | | | G | G | | | J | J | J | J | J | J | | J | J | J | J | J | M | |
| | 0.022 | | | C | | | | | | G | G | | | J | J | J | J | J | J | N | J | J | J | J | J | M | |
| | 0.033 | | C | | | | | | | G | G | | | J | J | J | J | N | | | J | J | J | J | J | M | |
| | 0.047 | | | | | | | | | G | G | G | | J | J | J | J | N | | | J | J | J | J | J | M | |
| 0.068 | | | | | | | | | G | G | G | | J | J | J | J | N | | | J | J | J | J | J | P | | |
| 0.10 | | | | | | | | | G | G | G | | J | J | J | J | | | | J | J | J | J | M | P | | |
| 0.15 | | | | | | G | G | | | | | | J | J | J | N | N | | | J | J | J | J | J | | | |
| 0.22 | | | | | | G | G | | | | | | J | J | N | N | N | | | J | J | J | J | Q | | | |
| 0.33 | | | | | | | | | | | | | N | N | N | N | N | | | J | J | M | P | Q | | | |
| 0.47 | | | | | | | | | | | | | N | N | N | N | N | | | M | M | M | P | Q | | | |
| 0.68 | | | | | | | | | | | | | N | N | N | | | | M | M | M | Q | Q | Q | | | |
| 1.0 | | | | | | | | | | | | | N | N | N | | | | M | M | | Q | Q | | | | |
| 1.5 | | | | | | | | | | | | | | | | | | | P | Q | Q | Q | | | | | |
| 2.2 | | | | | | | | | | | | | | | | | | | P* | Q | Q | Q | | | | | |
| 3.3 | | | | | | | | | | | | | | | | | | | | Q | Q | | | | | | |
| 4.7 | | | | | | | | | | | | | | | | | | | | P* | | | | | | | |
| 10 | | | | | | | | | | | | | | | | | | | | | Q* | | | | | | |
| 22 | | | | | | | | | | | | | | | | | | | | | Q* | | | | | | |
| 47 | | | | | | | | | | | | | | | | | | | | | | | | | | | |
| 100 | | | | | | | | | | | | | | | | | | | | | | | | | | | |
| WVDC | | 10 | 16 | 25 | 50 | 63 | 10 | 16 | 25 | 50 | 100 | 200 | 63 | 10 | 16 | 25 | 50 | 100 | 200 | 63 | 10 | 16 | 25 | 50 | 100 | 200 | 500 |
| SIZE | | AU02 | | | | | AU03 | | | | | AU05 | | | | | AU06 | | | | | | | | | | |

* Contact Factory

| Letter | A | C | E | G | J | K | M | N | P | Q | X | Y | Z |
|----------------|-----------------|-----------------|-----------------|-----------------|-----------------|-----------------|-----------------|-----------------|-----------------|-----------------|-----------------|-----------------|-----------------|
| Max. Thickness | 0.33 (0.013) | 0.56 (0.022) | 0.71 (0.028) | 0.90 (0.035) | 0.94 (0.037) | 1.02 (0.040) | 1.27 (0.050) | 1.40 (0.055) | 1.52 (0.060) | 1.78 (0.070) | 2.29 (0.090) | 2.54 (0.100) | 2.79 (0.110) |
| | PAPER | | | | | EMBOSS | | | | | | | |

MLCC Gold Termination – AU Series

Capacitance Range (X7R Dielectric)

PREFERRED SIZES ARE SHADED

| SIZE | AU10 | | | | | | | AU12 | | | | AU13 | | AU14 | | |
|--------------|--------------------------------|----|----|----|-----|-----|-----|--------------------------------|-----|-----|-----|--------------------------------|-----|--------------------------------|-----|--|
| Soldering | Reflow/Epoxy/ Wire Bond* | | | | | | | Reflow/Epoxy/ Wire Bond* | | | | Reflow/Epoxy/ Wire Bond* | | Reflow/Epoxy/ Wire Bond* | | |
| Packaging | Paper/Embossed | | | | | | | All Embossed | | | | All Embossed | | All Embossed | | |
| (L) Length | 3.20 ± 0.20 (0.126 ± 0.008) | | | | | | | 4.50 ± 0.30 (0.177 ± 0.012) | | | | 4.50 ± 0.30 (0.177 ± 0.012) | | 5.72 ± 0.25 (0.225 ± 0.010) | | |
| (W) Width | 2.50 ± 0.20 (0.098 ± 0.008) | | | | | | | 3.20 ± 0.20 (0.126 ± 0.008) | | | | 6.40 ± 0.40 (0.252 ± 0.016) | | 6.35 ± 0.25 (0.250 ± 0.010) | | |
| (t) Terminal | 0.50 ± 0.25 (0.020 ± 0.010) | | | | | | | 0.61 ± 0.36 (0.024 ± 0.014) | | | | 0.61 ± 0.36 (0.024 ± 0.014) | | 0.64 ± 0.39 (0.025 ± 0.015) | | |
| WVDC | 10 | 16 | 25 | 50 | 100 | 200 | 500 | 50 | 100 | 200 | 500 | 50 | 100 | 50 | 100 | |
| Cap (pF) | 100 | | | | | | | | | | | | | | | |
| | 150 | | | | | | | | | | | | | | | |
| | 220 | | | | | | | | | | | | | | | |
| | 330 | | | | | | | | | | | | | | | |
| | 470 | | | | | | | | | | | | | | | |
| 680 | | | | | | | | | | | | | | | | |
| | 1000 | | | | | | | | | | | | | | | |
| | 1500 | J | J | J | J | J | J | M | | | | | | | | |
| 2200 | J | J | J | J | J | J | M | | | | | | | | | |
| 3300 | J | J | J | J | J | J | M | | | | | | | | | |
| | 4700 | J | J | J | J | J | M | | | | | | | | | |
| | 6800 | J | J | J | J | J | M | | | | | | | | | |
| Cap (µF) | 0.010 | J | J | J | J | J | M | K | K | K | K | M | M | M | P | |
| | 0.015 | J | J | J | J | J | P | K | K | K | P | M | M | M | P | |
| | 0.022 | J | J | J | J | J | Q | K | K | K | P | M | M | M | P | |
| 0.033 | J | J | J | J | J | J | Q | K | K | K | X | M | M | M | P | |
| | 0.047 | J | J | J | J | J | | K | K | K | Z | M | M | M | P | |
| | 0.068 | J | J | J | J | J | M | K | K | K | Z | M | M | M | P | |
| 0.10 | J | J | J | J | J | M | | K | K | K | Z | M | M | M | P | |
| | 0.15 | J | J | J | J | M | Z | K | K | P | | M | M | M | P | |
| | 0.22 | J | J | J | J | P | Z | K | K | P | | M | M | M | P | |
| 0.33 | J | J | J | J | J | Q | | K | M | X | | M | M | M | P | |
| | 0.47 | M | M | M | M | Q | | K | P | | | M | M | M | P | |
| | 0.68 | M | M | P | X | X | | M | Q | | | M | P | M | P | |
| 1.0 | N | N | | X | Z | | | M | X | | | M | P | M | P | |
| | 1.5 | N | N | Z | Z | Z | | Z | Z | | | M | | M | X | |
| | 2.2 | X | X | Z | Z | Z | | Z | Z | | | | | M | | |
| 3.3 | X | X | Z | Z | | | | Z | | | | | | | | |
| | 4.7 | X | X | Z | Z | | | Z | | | | | | | | |
| | 10 | Z | Z | Z | | | | | | | | | | | | |
| 22 | | | | | | | | | | | | | | | | |
| | 47 | | | | | | | | | | | | | | | |
| | 100 | | | | | | | | | | | | | | | |
| WVDC | 10 | 16 | 25 | 50 | 100 | 200 | 500 | 50 | 100 | 200 | 500 | 50 | 100 | 50 | 100 | |
| SIZE | AU10 | | | | | | | AU12 | | | | AU13 | | AU14 | | |

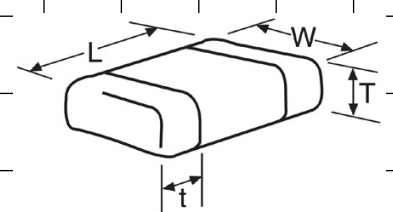

* Contact Factory

| Letter | A | C | E | G | J | K | M | N | P | Q | X | Y | Z |
|----------------|-----------------|-----------------|-----------------|-----------------|-----------------|-----------------|-----------------|-----------------|-----------------|-----------------|-----------------|-----------------|-----------------|
| Max. Thickness | 0.33 (0.013) | 0.56 (0.022) | 0.71 (0.028) | 0.90 (0.035) | 0.94 (0.037) | 1.02 (0.040) | 1.27 (0.050) | 1.40 (0.055) | 1.52 (0.060) | 1.78 (0.070) | 2.29 (0.090) | 2.54 (0.100) | 2.79 (0.110) |
| | PAPER | | | | | EMBOSSSED | | | | | | | |

MLCC Gold Termination – AU Series

AU16/AU17/AU18

| SIZE | | AU16 (0306) | | | | | AU17 (0508) | | | | | AU18 (0612) | | | | |
|-----------|------------|-----------------------------|-----|----|----|----|-----------------------------|----|----|----|----|-----------------------------|----|----|----|----|
| Packaging | | Embossed | | | | | Embossed | | | | | Embossed | | | | |
| Length | mm (in.) | 0.81 ± 0.15 (0.032 ± 0.006) | | | | | 1.27 ± 0.25 (0.050 ± 0.010) | | | | | 1.60 ± 0.25 (0.063 ± 0.010) | | | | |
| Width | mm (in.) | 1.60 ± 0.15 (0.063 ± 0.006) | | | | | 2.00 ± 0.25 (0.080 ± 0.010) | | | | | 3.20 ± 0.25 (0.126 ± 0.010) | | | | |
| Cap Code | WVDC | 4 | 6.3 | 10 | 16 | 25 | 6.3 | 10 | 16 | 25 | 50 | 6.3 | 10 | 16 | 25 | 50 |
| 102 | Cap 0.001 | A | A | A | A | S | S | S | S | V | S | S | S | S | V | |
| 222 | (µF) .0022 | A | A | A | A | S | S | S | S | V | S | S | S | S | V | |
| 332 | 0.0033 | A | A | A | A | S | S | S | S | V | S | S | S | S | V | |
| 472 | 0.0047 | A | A | A | A | S | S | S | S | V | S | S | S | S | V | |
| 682 | 0.0068 | A | A | A | A | S | S | S | S | V | S | S | S | S | V | |
| 103 | 0.01 | A | A | A | A | S | S | S | S | V | S | S | S | S | V | |
| 153 | 0.015 | A | A | A | A | S | S | S | S | V | S | S | S | S | W | |
| 223 | 0.022 | A | A | A | A | S | S | S | S | V | S | S | S | S | W | |
| 333 | 0.033 | A | A | A | A | S | S | S | V | V | S | S | S | S | W | |
| 473 | 0.047 | A | A | A | A | S | S | S | V | A | S | S | S | S | W | |
| 683 | 0.068 | A | A | A | A | S | S | S | A | A | S | S | S | V | W | |
| 104 | 0.1 | A | A | A | A | S | S | V | A | A | S | S | S | V | W | |
| 154 | 0.15 | A | A | A | A | S | S | V | A | A | S | S | S | W | W | |
| 224 | 0.22 | A | A | A | A | S | S | A | A | A | S | S | V | W | | |
| 334 | 0.33 | | | | | V | V | A | A | A | S | S | V | | | |
| 474 | 0.47 | | | | | V | V | A | A | A | S | S | V | | | |
| 684 | 0.68 | | | | | A | A | A | A | A | V | V | W | | | |
| 105 | 1 | A | | | | A | A | A | A | A | V | V | A | | | |
| 155 | 1.5 | | | | | A | A | A | A | A | W | W | | | | |
| 225 | 2.2 | | | | | | | | | | A | A | | | | |
| 335 | 3.3 | | | | | | | | | | A | A | | | | |
| 475 | 4.7 | | | | | | | | | | | | | | | |
| 685 | 6.8 | | | | | | | | | | | | | | | |
| 106 | 10 | | | | | | | | | | | | | | | |

PHYSICAL DIMENSIONS AND PAD LAYOUT

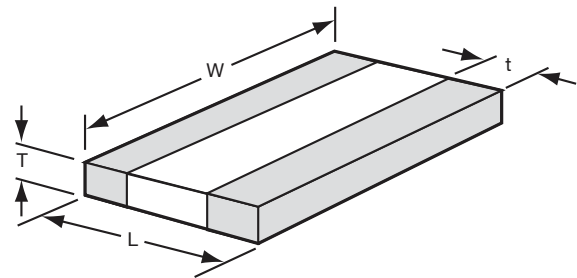

PHYSICAL DIMENSIONS

MM (IN.)

| | L | W | t |
|--------------------|-----------------------------|-----------------------------|------------------------|
| AU16 (0306) | 0.81 ± 0.15 (0.032 ± 0.006) | 1.60 ± 0.15 (0.063 ± 0.006) | 0.13 min. (0.005 min.) |
| AU17 (0508) | 1.27 ± 0.25 (0.050 ± 0.010) | 2.00 ± 0.25 (0.080 ± 0.010) | 0.13 min. (0.005 min.) |
| AU18 (0612) | 1.60 ± 0.25 (0.063 ± 0.010) | 3.20 ± 0.25 (0.126 ± 0.010) | 0.13 min. (0.005 min.) |

T - See Range Chart for Thickness and Codes

PAD LAYOUT DIMENSIONS

MM (IN.)

| | A | B | C |
|--------------------|--------------|--------------|---------------|
| AU16 (0306) | 0.31 (0.012) | 1.52 (0.060) | 0.51 (0.020) |
| AU17 (0508) | 0.51 (0.020) | 2.03 (0.080) | 0.51 (0.020) |
| AU18 (0612) | 0.76 (0.030) | 3.05 (0.120) | 0.635 (0.025) |

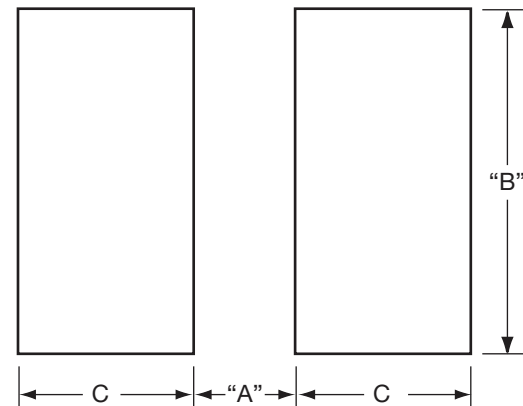

Solid = X7R

= X5R

= X7S

| mm (in.) | |
|--------------------|--------------|
| AU16 (0306) | |
| Code | Thickness |
| A | 0.56 (0.022) |

| mm (in.) | |
|--------------------|--------------|
| AU16 (0508) | |
| Code | Thickness |
| S | 0.56 (0.022) |
| V | 0.76 (0.030) |
| A | 1.02 (0.040) |

| mm (in.) | |
|--------------------|--------------|
| AU16 (0612) | |
| Code | Thickness |
| S | 0.56 (0.022) |
| V | 0.76 (0.030) |
| W | 1.02 (0.040) |
| A | 1.27 (0.050) |

MLCC Tin/Lead Termination "B" (LD Series)

C0G (NP0) – General Specifications

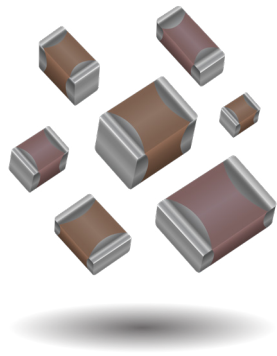

AVX Corporation will support those customers for commercial and military Multilayer Ceramic Capacitors with a termination consisting of 5% minimum lead. This termination is indicated by the use of a "B" in the 12th position of the AVX Catalog Part Number. This fulfills AVX's commitment to providing a full range of products to our customers. AVX has provided in the following pages a full range of values that we are currently offering in this special "B" termination. Please contact the factory if you require additional information on our MLCC Tin/Lead Termination "B" products.

PART NUMBER (SEE PAGE 4 FOR COMPLETE PART NUMBER EXPLANATION)

Not RoHS Compliant

| | | | | | | | | |
|---|---|--|---------------------------------|---|--------------------------------------|--|--|---------------------|
| LD05 | 5 | A | 101 | J | A | B | 2 | A |
| Size | Voltage | Dielectric | Capacitance Code (In pF) | Capacitance Tolerance | Failure Rate | Terminations | Packaging | Special Code |
| LD02 - 0402 LD03 - 0603 LD04 - 0504* LD05 - 0805 LD06 - 1206 LD10 - 1210 LD12 - 1812 LD13 - 1825 LD14 - 2225 LD20 - 2220 | 6.3V = 6 10V = Z 16V = Y 25V = 3 35V = D 50V = 5 100V = 1 200V = 2 500V = 7 | C0G (NP0) = A X7R = C X5R = D X8R = F | 2 Sig. Digits + Number of Zeros | B = ±10 pF (<10pF) C = ±25 pF (<10pF) D = ±50 pF (<10pF) F = ±1% (≥ 10 pF) G = ±2% (≥ 10 pF) J = ±5% K = ±10% M = ±20% | A = Not Applicable 4 = Automotive | B = 5% min lead X = FLEXITERM® with 5% min lead** **X7R only | 2 = 7" Reel 4 = 13" Reel Contact Factory For Multiples* | A = Std. Product |

*LD04 has the same CV ranges as LD03.

See FLEXITERM® section for CV options

NOTE: Contact factory for availability of Tolerance Options for Specific Part Numbers.
Contact factory for non-specified capacitance values.

Temperature Coefficient

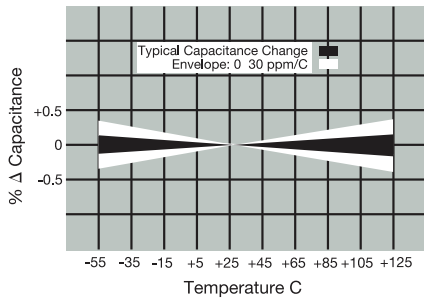

Δ Capacitance vs. Frequency

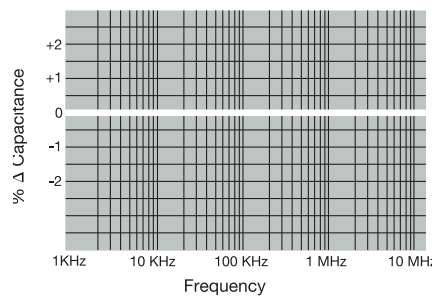

Insulation Resistance vs. Temperature

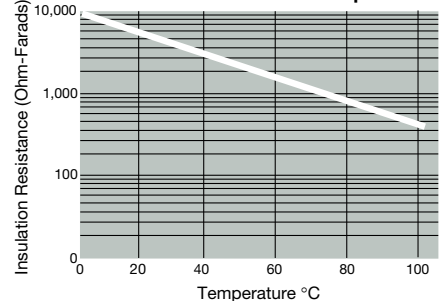

Variation of Impedance with Cap Value Impedance vs. Frequency 0805 - C0G (NP0) 10 pF vs. 100 pF vs. 1000 pF

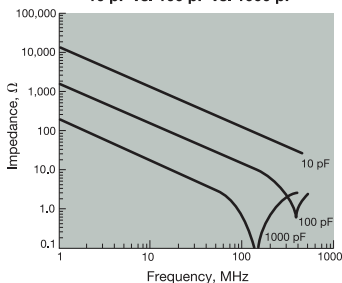

Variation of Impedance with Chip Size Impedance vs. Frequency 1000 pF - C0G (NP0)

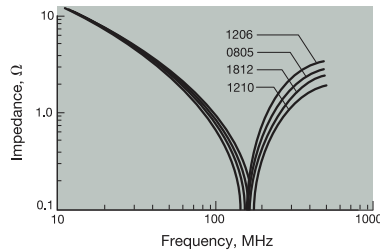

Variation of Impedance with Ceramic Formulation Impedance vs. Frequency 1000 pF - C0G (NP0) vs X7R 0805

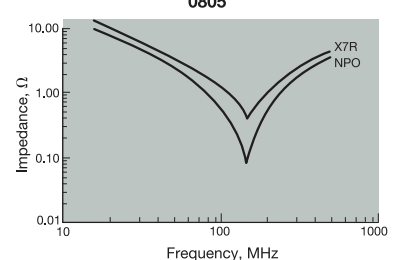

MLCC Tin/Lead Termination “B”

COG (NP0) – Specifications and Test Methods

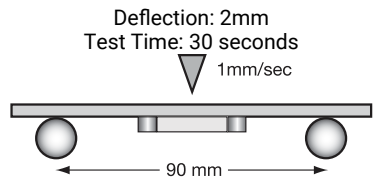
| Parameter/Test | | NP0 Specification Limits | Measuring Conditions | |
|--------------------------------|-----------------------|---|---|----------------|
| Operating Temperature Range | | -55°C to +125°C | Temperature Cycle Chamber | |
| Capacitance | | Within specified tolerance | Freq.: 1.0 MHz ± 10% for cap ≤ 1000 pF 1.0 kHz ± 10% for cap > 1000 pF Voltage: 1.0Vrms ± .2V | |
| Q | | <30 pF: Q ≥ 400+20 x Cap Value ≥30 pF: Q ≥ 1000 | | |
| Insulation Resistance | | 100,000MΩ or 1000MΩ - μF, whichever is less | Charge device with rated voltage for 60 ± 5 secs @ room temp/humidity | |
| Dielectric Strength | | No breakdown or visual defects | Charge device with 250% of rated voltage for 1-5 seconds, w/charge and discharge current limited to 50 mA (max) Note: Charge device with 150% of rated voltage for 500V devices. | |
| Resistance to Flexure Stresses | Appearance | No defects | Deflection: 2mm Test Time: 30 seconds  | |
| | Capacitance Variation | ±5% or ±.5 pF, whichever is greater | | |
| | Q | Meets Initial Values (As Above) | | |
| | Insulation Resistance | ≥ Initial Value x 0.3 | | |
| Solderability | | ≥ 95% of each terminal should be covered with fresh solder | Dip device in eutectic solder at 230 ± 5°C for 5.0 ± 0.5 seconds | |
| Resistance to Solder Heat | Appearance | No defects, <25% leaching of either end terminal | Dip device in eutectic solder at 260°C for 60 seconds. Store at room temperature for 24 ± 2 hours before measuring electrical properties. | |
| | Capacitance Variation | ≤ ±2.5% or ±.25 pF, whichever is greater | | |
| | Q | Meets Initial Values (As Above) | | |
| | Insulation Resistance | Meets Initial Values (As Above) | | |
| | Dielectric Strength | Meets Initial Values (As Above) | | |
| Thermal Shock | Appearance | No visual defects | Step 1: -55°C ± 2° | 30 ± 3 minutes |
| | Capacitance Variation | ≤ ±2.5% or ±.25 pF, whichever is greater | Step 2: Room Temp | ≤ 3 minutes |
| | Q | Meets Initial Values (As Above) | Step 3: +125°C ± 2° | 30 ± 3 minutes |
| | Insulation Resistance | Meets Initial Values (As Above) | Step 4: Room Temp | ≤ 3 minutes |
| | Dielectric Strength | Meets Initial Values (As Above) | Repeat for 5 cycles and measure after 24 hours at room temperature | |
| Load Life | Appearance | No visual defects | Charge device with twice rated voltage in test chamber set at 125°C ± 2°C for 1000 hours (+48, -0). Remove from test chamber and stabilize at room temperature for 24 hours before measuring. | |
| | Capacitance Variation | ≤ ±3.0% or ±.3 pF, whichever is greater | | |
| | Q | ≥ 30 pF: Q ≥ 350 ≥10 pF, <30 pF: Q ≥ 275 +5C/2 <10 pF: Q ≥ 200 +10C | | |
| | Insulation Resistance | ≥ Initial Value x 0.3 (See Above) | | |
| | Dielectric Strength | Meets Initial Values (As Above) | | |
| Load Humidity | Appearance | No visual defects | Store in a test chamber set at 85°C ± 2°C/ 85% ± 5% relative humidity for 1000 hours (+48, -0) with rated voltage applied. Remove from chamber and stabilize at room temperature for 24 ± 2 hours before measuring. | |
| | Capacitance Variation | ≤ ±5.0% or ±.5 pF, whichever is greater | | |
| | Q | ≥ 30 pF: Q ≥ 350 ≥10 pF, <30 pF: Q ≥ 275 +5C/2 <10 pF: Q ≥ 200 +10C | | |
| | Insulation Resistance | ≥ Initial Value x 0.3 (See Above) | | |
| | Dielectric Strength | Meets Initial Values (As Above) | | |

MLCC Tin/Lead Termination "B"

C0G (NP0) – Capacitance Range

PREFERRED SIZES ARE SHADED

| SIZE | LD02 | | | LD03 | | | LD05 | | | | LD06 | | | | | | | | |
|--------------|-------------|-----------------|----|-------------|-----------------|----|----------------|-----------------|----|----|----------------|-----------------|-----|----|----|----|-----|-----|-----|
| | Reflow/Wave | | | Reflow/Wave | | | Reflow/Wave | | | | Reflow/Wave | | | | | | | | |
| Soldering | All Paper | | | All Paper | | | Paper/Embossed | | | | Paper/Embossed | | | | | | | | |
| Packaging | All Paper | | | All Paper | | | Paper/Embossed | | | | Paper/Embossed | | | | | | | | |
| (L) Length | mm | 1.00 ± 0.10 | | | 1.60 ± 0.15 | | | 2.01 ± 0.20 | | | | 3.20 ± 0.20 | | | | | | | |
| | (in.) | (0.040 ± 0.004) | | | (0.063 ± 0.006) | | | (0.079 ± 0.008) | | | | (0.126 ± 0.008) | | | | | | | |
| (W) Width | mm | 0.50 ± 0.10 | | | 0.81 ± 0.15 | | | 1.25 ± 0.20 | | | | 1.60 ± 0.20 | | | | | | | |
| | (in.) | (0.020 ± 0.004) | | | (0.032 ± 0.006) | | | (0.049 ± 0.008) | | | | (0.063 ± 0.008) | | | | | | | |
| (t) Terminal | mm | 0.25 ± 0.15 | | | 0.35 ± 0.15 | | | 0.50 ± 0.25 | | | | 0.50 ± 0.25 | | | | | | | |
| | (in.) | (0.010 ± 0.006) | | | (0.014 ± 0.006) | | | (0.020 ± 0.010) | | | | (0.020 ± 0.010) | | | | | | | |
| WVDC | | 16 | 25 | 50 | 16 | 25 | 50 | 100 | 16 | 25 | 50 | 100 | 200 | 16 | 25 | 50 | 100 | 200 | 500 |
| Cap (pF) | 0.5 | C | C | C | G | G | G | G | J | J | J | J | J | J | J | J | J | J | J |
| | 1.0 | C | C | C | G | G | G | G | J | J | J | J | J | J | J | J | J | J | J |
| | 1.2 | C | C | C | G | G | G | G | J | J | J | J | J | J | J | J | J | J | J |
| | 1.5 | C | C | C | G | G | G | G | J | J | J | J | J | J | J | J | J | J | J |
| | 1.8 | C | C | C | G | G | G | G | J | J | J | J | J | J | J | J | J | J | J |
| | 2.2 | C | C | C | G | G | G | G | J | J | J | J | J | J | J | J | J | J | J |
| | 2.7 | C | C | C | G | G | G | G | J | J | J | J | J | J | J | J | J | J | J |
| | 3.3 | C | C | C | G | G | G | G | J | J | J | J | J | J | J | J | J | J | J |
| | 3.9 | C | C | C | G | G | G | G | J | J | J | J | J | J | J | J | J | J | J |
| | 4.7 | C | C | C | G | G | G | G | J | J | J | J | J | J | J | J | J | J | J |
| | 5.6 | C | C | C | G | G | G | G | J | J | J | J | J | J | J | J | J | J | J |
| | 6.8 | C | C | C | G | G | G | G | J | J | J | J | J | J | J | J | J | J | J |
| | 8.2 | C | C | C | G | G | G | G | J | J | J | J | J | J | J | J | J | J | J |
| | 10 | C | C | C | G | G | G | G | J | J | J | J | J | J | J | J | J | J | J |
| | 12 | C | C | C | G | G | G | G | J | J | J | J | J | J | J | J | J | J | J |
| | 15 | C | C | C | G | G | G | G | J | J | J | J | J | J | J | J | J | J | J |
| | 18 | C | C | C | G | G | G | G | J | J | J | J | J | J | J | J | J | J | J |
| | 22 | C | C | C | G | G | G | G | J | J | J | J | J | J | J | J | J | J | J |
| | 27 | C | C | C | G | G | G | G | J | J | J | J | J | J | J | J | J | J | J |
| | 33 | C | C | C | G | G | G | G | J | J | J | J | J | J | J | J | J | J | J |
| | 39 | C | C | C | G | G | G | G | J | J | J | J | J | J | J | J | J | J | J |
| | 47 | C | C | C | G | G | G | G | J | J | J | J | J | J | J | J | J | J | J |
| | 56 | C | C | C | G | G | G | G | J | J | J | J | J | J | J | J | J | J | J |
| | 68 | C | C | C | G | G | G | G | J | J | J | J | J | J | J | J | J | J | J |
| | 82 | C | C | C | G | G | G | G | J | J | J | J | J | J | J | J | J | J | J |
| | 100 | C | C | C | G | G | G | G | J | J | J | J | J | J | J | J | J | J | J |
| | 120 | C | C | C | G | G | G | G | J | J | J | J | J | J | J | J | J | J | J |
| | 150 | C | C | C | G | G | G | G | J | J | J | J | J | J | J | J | J | J | J |
| | 180 | C | C | C | G | G | G | G | J | J | J | J | J | J | J | J | J | J | J |
| | 220 | C | C | C | G | G | G | G | J | J | J | J | J | J | J | J | J | J | M |
| | 270 | C | C | C | G | G | G | G | J | J | J | J | M | J | J | J | J | J | M |
| | 330 | C | C | C | G | G | G | G | J | J | J | J | M | J | J | J | J | J | M |
| | 390 | C | C | C | G | G | G | G | J | J | J | J | M | J | J | J | J | J | M |
| | 470 | C | C | C | G | G | G | G | J | J | J | J | M | J | J | J | J | J | M |
| | 560 | | | | G | G | G | G | J | J | J | J | M | J | J | J | J | J | M |
| | 680 | | | | G | G | G | G | J | J | J | J | | J | J | J | J | J | P |
| | 820 | | | | G | G | G | G | J | J | J | J | | J | J | J | J | J | P |
| | 1000 | | | | G | G | G | G | J | J | J | J | | J | J | J | J | J | Q |
| | 1200 | | | | | G | | | J | J | J | J | | J | J | J | J | J | Q |
| | 1500 | | | | | | | | J | J | J | J | | J | J | J | J | J | Q |
| | 1800 | | | | | | | | J | J | J | J | | J | J | M | M | | |
| | 2200 | | | | | | | | J | J | N | | | J | J | M | M | | |
| | 2700 | | | | | | | | J | J | N | | | J | J | M | P | | |
| | 3300 | | | | | | | | J | J | | | | J | J | M | P | | |
| | 3900 | | | | | | | | J | J | | | | J | J | M | P | | |
| | 4700 | | | | | | | | J | J | | | | J | J | M | P | | |
| | 5600 | | | | | | | | | | | | | J | J | M | | | |
| | 6800 | | | | | | | | | | | | | M | M | | | | |
| | 8200 | | | | | | | | | | | | | M | M | | | | |
| Cap (pF) | 0.010 | | | | | | | | | | | | | M | M | | | | |
| | 0.012 | | | | | | | | | | | | | | | | | | |
| | 0.015 | | | | | | | | | | | | | | | | | | |
| | 0.018 | | | | | | | | | | | | | | | | | | |
| | 0.022 | | | | | | | | | | | | | | | | | | |
| | 0.027 | | | | | | | | | | | | | | | | | | |
| | 0.033 | | | | | | | | | | | | | | | | | | |
| | 0.039 | | | | | | | | | | | | | | | | | | |
| | 0.047 | | | | | | | | | | | | | | | | | | |
| | 0.068 | | | | | | | | | | | | | | | | | | |
| | 0.082 | | | | | | | | | | | | | | | | | | |
| | 0.1 | | | | | | | | | | | | | | | | | | |
| WVDC | | 16 | 25 | 50 | 16 | 25 | 50 | 100 | 16 | 25 | 50 | 100 | 200 | 16 | 25 | 50 | 100 | 200 | 500 |
| SIZE | | LD02 | | | LD03 | | | LD05 | | | | LD06 | | | | | | | |

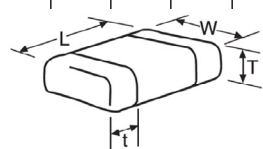

| Letter | A | C | E | G | J | K | M | N | P | Q | X | Y | Z |
|----------------|-----------------|-----------------|-----------------|-----------------|-----------------|-----------------|-----------------|-----------------|-----------------|-----------------|-----------------|-----------------|-----------------|
| Max. Thickness | 0.33 (0.013) | 0.56 (0.022) | 0.71 (0.028) | 0.90 (0.035) | 0.94 (0.037) | 1.02 (0.040) | 1.27 (0.050) | 1.40 (0.055) | 1.52 (0.060) | 1.78 (0.070) | 2.29 (0.090) | 2.54 (0.100) | 2.79 (0.110) |
| | PAPER | | | | | EMBOSS | | | | | | | |

MLCC Tin/Lead Termination "B"

COG (NP0) – Capacitance Range



PREFERRED SIZES ARE SHADED



| SIZE | LD10 | | | | | LD12 | | | | | LD13 | | | LD14 | | |
|--------------|--------------------------------|----|-----|-----|-----|--------------------------------|----|-----|-----|-----|--------------------------------|-----|-----|--------------------------------|-----|-----|
| Soldering | Reflow Only | | | | | Reflow Only | | | | | Reflow Only | | | Reflow Only | | |
| Packaging | Paper/Embossed | | | | | All Embossed | | | | | All Embossed | | | All Embossed | | |
| (L) Length | 3.20 ± 0.20 (0.126 ± 0.008) | | | | | 4.50 ± 0.30 (0.177 ± 0.012) | | | | | 4.50 ± 0.30 (0.177 ± 0.012) | | | 5.72 ± 0.25 (0.225 ± 0.010) | | |
| (W) Width | 2.50 ± 0.20 (0.098 ± 0.008) | | | | | 3.20 ± 0.20 (0.126 ± 0.008) | | | | | 6.40 ± 0.40 (0.252 ± 0.016) | | | 6.35 ± 0.25 (0.250 ± 0.010) | | |
| (t) Terminal | 0.50 ± 0.25 (0.020 ± 0.010) | | | | | 0.61 ± 0.36 (0.024 ± 0.014) | | | | | 0.61 ± 0.36 (0.024 ± 0.014) | | | 0.64 ± 0.39 (0.025 ± 0.015) | | |
| Cap (pF) | 25 | 50 | 100 | 200 | 500 | 25 | 50 | 100 | 200 | 500 | 50 | 100 | 200 | 50 | 100 | 200 |
| 0.5 | | | | | | | | | | | | | | | | |
| 1.0 | | | | | | | | | | | | | | | | |
| 1.2 | | | | | | | | | | | | | | | | |
| 1.5 | | | | | | | | | | | | | | | | |
| 1.8 | | | | | | | | | | | | | | | | |
| 2.2 | | | | | | | | | | | | | | | | |
| 2.7 | | | | | | | | | | | | | | | | |
| 3.3 | | | | | | | | | | | | | | | | |
| 3.9 | | | | | | | | | | | | | | | | |
| 4.7 | | | | | | | | | | | | | | | | |
| 5.6 | | | | | | | | | | | | | | | | |
| 6.8 | | | | | | | | | | | | | | | | |
| 8.2 | | | | | | | | | | | | | | | | |
| 10 | | | | | J | | | | | | | | | | | |
| 12 | | | | | J | | | | | | | | | | | |
| 15 | | | | | J | | | | | | | | | | | |
| 18 | | | | | J | | | | | | | | | | | |
| 22 | | | | | J | | | | | | | | | | | |
| 27 | | | | | J | | | | | | | | | | | |
| 33 | | | | | J | | | | | | | | | | | |
| 39 | | | | | J | | | | | | | | | | | |
| 47 | | | | | J | | | | | | | | | | | |
| 56 | | | | | J | | | | | | | | | | | |
| 68 | | | | | J | | | | | | | | | | | |
| 82 | | | | | J | | | | | | | | | | | |
| 100 | | | | | J | | | | | | | | | | | |
| 120 | | | | | J | | | | | | | | | | | |
| 150 | | | | | J | | | | | | | | | | | |
| 180 | | | | | J | | | | | | | | | | | |
| 220 | | | | | J | | | | | | | | | | | |
| 270 | | | | | J | | | | | | | | | | | |
| 330 | | | | | J | | | | | | | | | | | |
| 390 | | | | | M | | | | | | | | | | | |
| 470 | | | | | M | | | | | | | | | | | |
| 560 | J | J | J | J | M | | | | | | | | | | | |
| 680 | J | J | J | J | M | | | | | | | | | | | |
| 820 | J | J | J | J | M | | | | | | | | | | | |
| 1000 | J | J | J | J | M | K | K | K | K | M | M | M | M | M | M | P |
| 1200 | J | J | J | J | M | K | K | K | K | M | M | M | M | M | M | P |
| 1500 | J | J | J | J | M | K | K | K | K | M | M | M | M | M | M | P |
| 1800 | J | J | J | J | M | K | K | K | K | M | M | M | M | M | M | P |
| 2200 | J | J | J | J | Q | K | K | K | K | P | M | M | M | M | M | P |
| 2700 | J | J | J | J | Q | K | K | K | K | Q | M | M | M | M | M | P |
| 3300 | J | J | J | J | | P | P | P | P | Q | M | M | M | M | M | P |
| 3900 | J | J | J | M | | P | P | P | P | Q | M | M | M | M | M | P |
| 4700 | J | J | J | M | | P | P | P | P | Y | M | M | M | M | M | P |
| 5600 | J | J | J | | | P | P | P | P | Y | M | M | M | M | M | P |
| 6800 | J | J | J | | | P | P | Q | Q | Y | M | M | M | M | M | P |
| 8200 | J | J | J | | | P | P | Q | Q | Y | M | M | M | M | M | P |
| Cap (pF) | 0.010 | J | J | | | P | P | Q | Q | Y | M | M | | M | M | P |
| 0.012 | J | J | | | | P | P | Q | X | Y | M | M | | M | M | P |
| 0.015 | | | | | | P | P | Q | X | Y | M | M | | M | M | Y |
| 0.018 | | | | | | P | P | X | X | Y | P | M | | M | M | Y |
| 0.022 | | | | | | P | P | X | X | | P | | | M | M | Y |
| 0.027 | | | | | | Q | X | X | Z | | P | | | P | Y | Y |
| 0.033 | | | | | | Q | X | X | Z | | P | | | P | | |
| 0.039 | | | | | | X | X | Z | Z | | P | | | P | | |
| 0.047 | | | | | | X | X | Z | Z | | P | | | P | | |
| 0.068 | | | | | | Z | Z | Z | | | | | | P | | |
| 0.082 | | | | | | Z | Z | Z | | | | | | Q | | |
| 0.1 | | | | | | Z | Z | Z | | | | | | Q | | |
| SIZE | 25 | 50 | 100 | 200 | 500 | 25 | 50 | 100 | 200 | 500 | 50 | 100 | 200 | 50 | 100 | 200 |

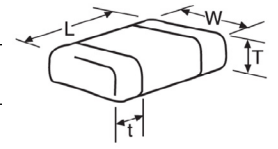

| Letter | A | C | E | G | J | K | M | N | P | Q | X | Y | Z |
|----------------|-----------------|-----------------|-----------------|-----------------|-----------------|-----------------|-----------------|-----------------|-----------------|-----------------|-----------------|-----------------|-----------------|
| Max. Thickness | 0.33 (0.013) | 0.56 (0.022) | 0.71 (0.028) | 0.90 (0.035) | 0.94 (0.037) | 1.02 (0.040) | 1.27 (0.050) | 1.40 (0.055) | 1.52 (0.060) | 1.78 (0.070) | 2.29 (0.090) | 2.54 (0.100) | 2.79 (0.110) |
| | PAPER | | | | | EMBOSSSED | | | | | | | |



The Important Information/Disclaimer is incorporated in the catalog where these specifications came from or available online at www.avx.com/disclaimer/ by reference and should be reviewed in full before placing any order.

MLCC Tin/Lead Termination “B”

X8R – General Specifications

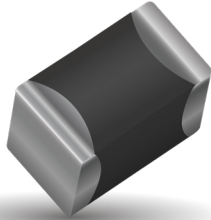

AVX Corporation will support those customers for commercial and military Multilayer Ceramic Capacitors with a termination consisting of 5% minimum lead. This termination is indicated by the use of a “B” in the 12th position of the AVX Catalog Part Number. This fulfills AVX’s commitment to providing a full range of products to our customers. AVX has provided in the following pages a full range of values that we are currently offering in this special “B” termination. Please contact the factory if you require additional information on our MLCC Tin/Lead Termination “B” products.

Not RoHS Compliant

PART NUMBER (SEE PAGE 4 FOR COMPLETE PART NUMBER EXPLANATION)

| | | | | | | | | |
|---|---|-------------------|---------------------------------------|---|-----------------------|--|--|---------------------|
| LD05 | 5 | F | 101 | J | A | B | 2 | A |
| | | | | | | | | |
| Size | Voltage | Dielectric | Capacitance Code (In pF) | Capacitance Tolerance | Failure Rate | Terminations | Packaging | Special Code |
| LD02 - 0402 LD03 - 0603 LD04 - 0504* LD05 - 0805 LD06 - 1206 LD10 - 1210 LD12 - 1812 LD13 - 1825 LD14 - 2225 LD20 - 2220 | 6.3V = 6 10V = Z 16V = Y 25V = 3 35V = D 50V = 5 100V = 1 200V = 2 500V = 7 | X8R = F | 2 Sig. Digits + Number of Zeros | B = ±10 pF (<10pF) C = ±.25 pF (<10pF) D = ±.50 pF (<10pF) F = ±1% (≥ 10 pF) G = ±2% (≥ 10 pF) J = ±5% K = ±10% M = ±20% | A = Not Applicable | B = 5% min lead X = FLEXITERM® with 5% min lead** **X7R only | 2 = 7" Reel 4 = 13" Reel Contact Factory For Multiples* | A = Std. Product |

LD04 has the same CV ranges as LD03.

See FLEXITERM® section for CV options

NOTE: Contact factory for availability of Tolerance Options for Specific Part Numbers.
Contact factory for non-specified capacitance values.

MLCC Tin/Lead Termination “B”

X8R – Specifications and Test Methods

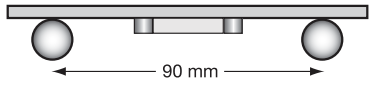
| Parameter/Test | | X8R Specification Limits | Measuring Conditions | |
|--------------------------------|-----------------------|---|---|----------------|
| Operating Temperature Range | | -55°C to +150°C | Temperature Cycle Chamber | |
| Capacitance | | Within specified tolerance | Freq.: 1.0 kHz ± 10% Voltage: 1.0Vrms ± .2V | |
| Dissipation Factor | | ≤ 2.5% for ≥ 50V DC rating ≤ 3.5% for 25V DC and 16V DC rating | | |
| Insulation Resistance | | 100,000MΩ or 1000MΩ - μF, whichever is less | Charge device with rated voltage for 120 ± 5 secs @ room temp/humidity | |
| Dielectric Strength | | No breakdown or visual defects | Charge device with 250% of rated voltage for 1-5 seconds, w/charge and discharge current limited to 50 mA (max) Note: Charge device with 150% of rated voltage for 500V devices. | |
| Resistance to Flexure Stresses | Appearance | No defects | Deflection: 2mm Test Time: 30 seconds 1mm/sec  | |
| | Capacitance Variation | ≤ ±12% | | |
| | Dissipation Factor | Meets Initial Values (As Above) | | |
| | Insulation Resistance | ≥ Initial Value x 0.3 | | |
| Solderability | | ≥ 95% of each terminal should be covered with fresh solder | Dip device in eutectic solder at 230 ± 5°C for 5.0 ± 0.5 seconds | |
| Resistance to Solder Heat | Appearance | No defects, <25% leaching of either end terminal | Dip device in eutectic solder at 260°C for 60 seconds. Store at room temperature for 24 ± 2 hours before measuring electrical properties. | |
| | Capacitance Variation | ≤ ±7.5% | | |
| | Dissipation Factor | Meets Initial Values (As Above) | | |
| | Insulation Resistance | Meets Initial Values (As Above) | | |
| | Dielectric Strength | Meets Initial Values (As Above) | | |
| Thermal Shock | Appearance | No visual defects | Step 1: -55°C ± 2° | 30 ± 3 minutes |
| | Capacitance Variation | ≤ ±7.5% | Step 2: Room Temp | ≤ 3 minutes |
| | Dissipation Factor | Meets Initial Values (As Above) | Step 3: +125°C ± 2° | 30 ± 3 minutes |
| | Insulation Resistance | Meets Initial Values (As Above) | Step 4: Room Temp | ≤ 3 minutes |
| | Dielectric Strength | Meets Initial Values (As Above) | Repeat for 5 cycles and measure after 24 ± 2 hours at room temperature | |
| Load Life | Appearance | No visual defects | Charge device with 1.5 rated voltage (≤ 10V) in test chamber set at 150°C ± 2°C for 1000 hours (+48, -0) Remove from test chamber and stabilize at room temperature for 24 ± 2 hours before measuring. | |
| | Capacitance Variation | ≤ ±12.5% | | |
| | Dissipation Factor | ≤ Initial Value x 2.0 (See Above) | | |
| | Insulation Resistance | ≥ Initial Value x 0.3 (See Above) | | |
| | Dielectric Strength | Meets Initial Values (As Above) | | |
| Load Humidity | Appearance | No visual defects | Store in a test chamber set at 85°C ± 2°C/ 85% ± 5% relative humidity for 1000 hours (+48, -0) with rated voltage applied. Remove from chamber and stabilize at room temperature and humidity for 24 ± 2 hours before measuring. | |
| | Capacitance Variation | ≤ ±12.5% | | |
| | Dissipation Factor | ≤ Initial Value x 2.0 (See Above) | | |
| | Insulation Resistance | ≥ Initial Value x 0.3 (See Above) | | |
| | Dielectric Strength | Meets Initial Values (As Above) | | |

MLCC Tin/Lead Termination "B"

X8R – Capacitance Range



| SIZE | | | LD03 | | LD05 | | LD06 | |
|------|------|-------|------|-----|------|-----|------|-----|
| | WVDC | | 25V | 50V | 25V | 50V | 25V | 50V |
| 271 | Cap | 270 | G | G | | | | |
| 331 | (pF) | 330 | G | G | J | J | | |
| 471 | | 470 | G | G | J | J | | |
| 681 | | 680 | G | G | J | J | | |
| 102 | | 1000 | G | G | J | J | J | J |
| 152 | | 1500 | G | G | J | J | J | J |
| 182 | | 1800 | G | G | J | J | J | J |
| 222 | | 2200 | G | G | J | J | J | J |
| 272 | | 2700 | G | G | J | J | J | J |
| 332 | | 3300 | G | G | J | J | J | J |
| 392 | | 3900 | G | G | J | J | J | J |
| 472 | | 4700 | G | G | J | J | J | J |
| 562 | | 5600 | G | G | J | J | J | J |
| 682 | | 6800 | G | G | J | J | J | J |
| 822 | Cap | 8200 | G | G | J | J | J | J |
| 103 | (µF) | 0.01 | G | G | J | J | J | J |
| 123 | | 0.012 | G | G | J | J | J | J |
| 153 | | 0.015 | G | G | J | J | J | J |
| 183 | | 0.018 | G | G | J | J | J | J |
| 223 | | 0.022 | G | G | J | J | J | J |
| 273 | | 0.027 | G | G | J | J | J | J |
| 333 | | 0.033 | G | G | J | J | J | J |
| 393 | | 0.039 | G | G | J | J | J | J |
| 473 | | 0.047 | G | G | J | J | J | J |
| 563 | | 0.056 | G | | N | N | M | M |
| 683 | | 0.068 | G | | N | N | M | M |
| 823 | | 0.082 | | | N | N | M | M |
| 104 | | 0.1 | | | N | N | M | M |
| 124 | | 0.12 | | | N | N | M | M |
| 154 | | 0.15 | | | N | N | M | M |
| 184 | | 0.18 | | | N | | M | M |
| 224 | | 0.22 | | | N | | M | M |
| 274 | | 0.27 | | | | | M | M |
| 334 | | 0.33 | | | | | M | M |
| 394 | | 0.39 | | | | | M | |
| 474 | | 0.47 | | | | | M | |
| 684 | | 0.68 | | | | | | |
| 824 | | 0.82 | | | | | | |
| 105 | | 1 | | | | | | |
| | WVDC | | 25V | 50V | 25V | 50V | 25V | 50V |
| SIZE | | | LD03 | | LD05 | | LD06 | |

| Letter | A | C | E | G | J | K | M | N | P | Q | X | Y | Z |
|----------------|-----------------|-----------------|-----------------|-----------------|-----------------|-----------------|-----------------|-----------------|-----------------|-----------------|-----------------|-----------------|-----------------|
| Max. Thickness | 0.33 (0.013) | 0.56 (0.022) | 0.71 (0.028) | 0.90 (0.035) | 0.94 (0.037) | 1.02 (0.040) | 1.27 (0.050) | 1.40 (0.055) | 1.52 (0.060) | 1.78 (0.070) | 2.29 (0.090) | 2.54 (0.100) | 2.79 (0.110) |
| | PAPER | | | | | EMBOSSED | | | | | | | |

MLCC Tin/Lead Termination "B"

X7R – General Specifications

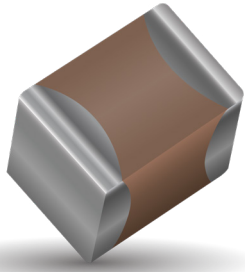

AVX Corporation will support those customers for commercial and military Multilayer Ceramic Capacitors with a termination consisting of 5% minimum lead. This termination is indicated by the use of a "B" in the 12th position of the AVX Catalog Part Number. This fulfills AVX's commitment to providing a full range of products to our customers. AVX has provided in the following pages a full range of values that we are currently offering in this special "B" termination. Please contact the factory if you require additional information on our MLCC Tin/Lead Termination "B" products.

Not RoHS Compliant

PART NUMBER (SEE PAGE 4 FOR COMPLETE PART NUMBER EXPLANATION)

| LD05 | 5 | C | 101 | J | A | B | 2 | A |
|--|---|-------------------|---------------------------------|---|---------------------|--|--|---------------------|
| Size | Voltage | Dielectric | Capacitance Code (In pF) | Capacitance Tolerance | Failure Rate | Terminations | Packaging | Special Code |
| LD03 - 0603 LD04 - 0504* LD05 - 0805 LD06 - 1206 LD10 - 1210 LD12 - 1812 LD13 - 1825 LD14 - 2225 LD20 - 2220 | 6.3V = 6 10V = Z 16V = Y 25V = 3 35V = D 50V = 5 100V = 1 200V = 2 500V = 7 | X7R = C | 2 Sig. Digits + Number of Zeros | B = ±10 pF (<10pF) C = ±25 pF (<10pF) D = ±50 pF (<10pF) F = ±1% (≥ 10 pF) G = ±2% (≥ 10 pF) J = ±5% K = ±10% M = ±20% | A = Not Applicable | B = 5% min lead X = FLEXITERM® with 5% min lead** **X7R only | 2 = 7" Reel 4 = 13" Reel Contact Factory For Multiples* | A = Std. Product |

*LD04 has the same CV ranges as LD03.

See FLEXITERM® section for CV options

NOTE: Contact factory for availability of Tolerance Options for Specific Part Numbers.
Contact factory for non-specified capacitance values.

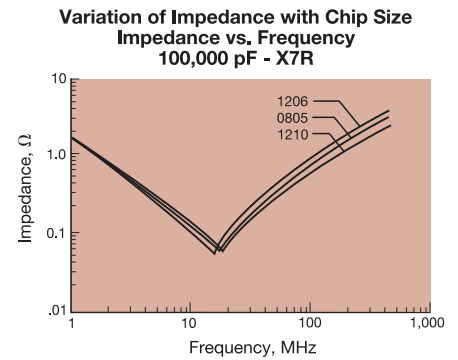
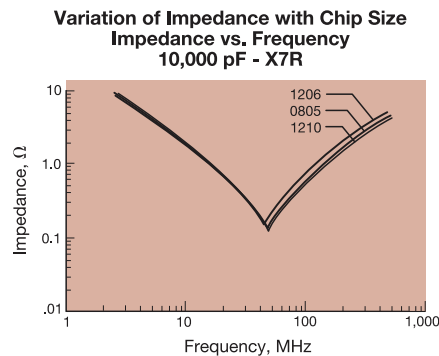
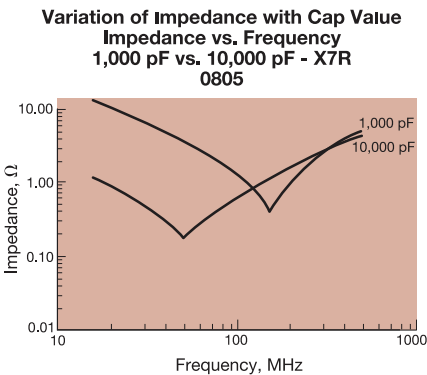
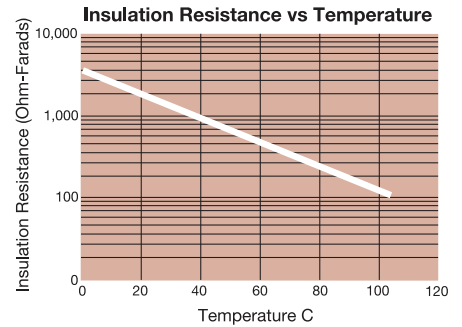
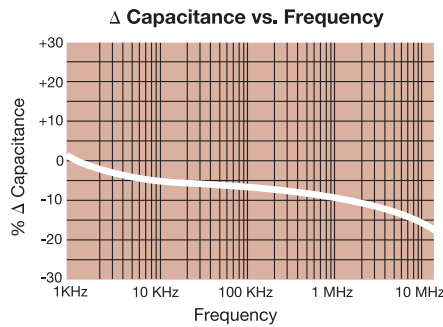
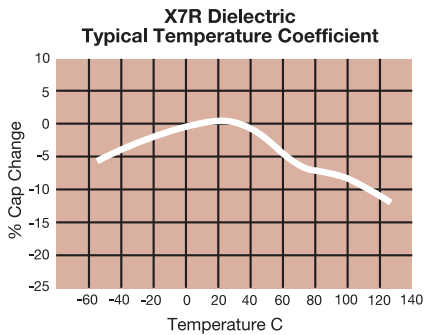

The Important Information/Disclaimer is incorporated in the catalog where these specifications came from or available online at www.avx.com/disclaimer/ by reference and should be reviewed in full before placing any order.

MLCC Tin/Lead Termination “B”

X7R – Specifications and Test Methods

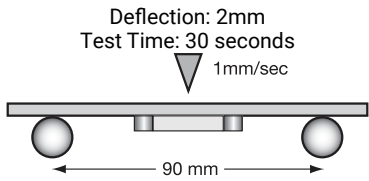
| Parameter/Test | | X7R Specification Limits | Measuring Conditions | |
|--------------------------------|-----------------------|--|---|----------------|
| Operating Temperature Range | | -55°C to +125°C | Temperature Cycle Chamber | |
| Capacitance | | Within specified tolerance | Freq.: 1.0 kHz ± 10% Voltage: 1.0Vrms ± .2V | |
| Dissipation Factor | | ≤ 10% for ≥ 50V DC rating ≤ 12.5% for 25V DC rating ≤ 12.5% for 25V and 16V DC rating ≤ 12.5% for ≤ 10V DC rating | | |
| Insulation Resistance | | 100,000MΩ or 1000MΩ - μF, whichever is less | Charge device with rated voltage for 120 ± 5 secs @ room temp/humidity | |
| Dielectric Strength | | No breakdown or visual defects | Charge device with 250% of rated voltage for 1-5 seconds, w/charge and discharge current limited to 50 mA (max) Note: Charge device with 150% of rated voltage for 500V devices. | |
| Resistance to Flexure Stresses | Appearance | No defects |  | |
| | Capacitance Variation | ≤ ±12% | | |
| | Dissipation Factor | Meets Initial Values (As Above) | | |
| | Insulation Resistance | ≥ Initial Value x 0.3 | | |
| Solderability | | ≥ 95% of each terminal should be covered with fresh solder | Dip device in eutectic solder at 230 ± 5°C for 5.0 ± 0.5 seconds | |
| Resistance to Solder Heat | Appearance | No defects, <25% leaching of either end terminal | Dip device in eutectic solder at 260°C for 60 seconds. Store at room temperature for 24 ± 2 hours before measuring electrical properties. | |
| | Capacitance Variation | ≤ ±7.5% | | |
| | Dissipation Factor | Meets Initial Values (As Above) | | |
| | Insulation Resistance | Meets Initial Values (As Above) | | |
| | Dielectric Strength | Meets Initial Values (As Above) | | |
| Thermal Shock | Appearance | No visual defects | Step 1: -55°C ± 2° | 30 ± 3 minutes |
| | Capacitance Variation | ≤ ±7.5% | Step 2: Room Temp | ≤ 3 minutes |
| | Dissipation Factor | Meets Initial Values (As Above) | Step 3: +125°C ± 2° | 30 ± 3 minutes |
| | Insulation Resistance | Meets Initial Values (As Above) | Step 4: Room Temp | ≤ 3 minutes |
| | Dielectric Strength | Meets Initial Values (As Above) | Repeat for 5 cycles and measure after 24 ± 2 hours at room temperature | |
| Load Life | Appearance | No visual defects | Charge device with 1.5 rated voltage (≤ 10V) in test chamber set at 125°C ± 2°C for 1000 hours (+48, -0) Remove from test chamber and stabilize at room temperature for 24 ± 2 hours before measuring. | |
| | Capacitance Variation | ≤ ±12.5% | | |
| | Dissipation Factor | ≤ Initial Value x 2.0 (See Above) | | |
| | Insulation Resistance | ≥ Initial Value x 0.3 (See Above) | | |
| | Dielectric Strength | Meets Initial Values (As Above) | | |
| Load Humidity | Appearance | No visual defects | Store in a test chamber set at 85°C ± 2°C/ 85% ± 5% relative humidity for 1000 hours (+48, -0) with rated voltage applied. Remove from chamber and stabilize at room temperature and humidity for 24 ± 2 hours before measuring. | |
| | Capacitance Variation | ≤ ±12.5% | | |
| | Dissipation Factor | ≤ Initial Value x 2.0 (See Above) | | |
| | Insulation Resistance | ≥ Initial Value x 0.3 (See Above) | | |
| | Dielectric Strength | Meets Initial Values (As Above) | | |

MLCC Tin/Lead Termination "B"

X7R – Capacitance Range



PREFERRED SIZES ARE SHADED

| SIZE | LD02 | | | LD03 | | | | | | LD05 | | | | | | LD06 | | | | | | | | | | |
|--------------|-------------|-------------|----|-------------|-----|----|----|----|----|----------------|-----|-----|----|----|----|----------------|-----|-----|-----|----|----|----|----|-----|-----|-----|
| | Reflow/Wave | | | Reflow/Wave | | | | | | Reflow/Wave | | | | | | Reflow/Wave | | | | | | | | | | |
| Packaging | All Paper | | | All Paper | | | | | | Paper/Embossed | | | | | | Paper/Embossed | | | | | | | | | | |
| (L) Length | mm | 1.00 ± 0.10 | | 1.60 ± 0.15 | | | | | | 2.01 ± 0.20 | | | | | | 3.20 ± 0.20 | | | | | | | | | | |
| (W) Width | mm | 0.50 ± 0.10 | | 0.81 ± 0.15 | | | | | | 1.25 ± 0.20 | | | | | | 1.60 ± 0.20 | | | | | | | | | | |
| (t) Terminal | mm | 0.25 ± 0.15 | | 0.35 ± 0.15 | | | | | | 0.50 ± 0.25 | | | | | | 0.50 ± 0.25 | | | | | | | | | | |
| WVDC | | 16 | 25 | 50 | 6.3 | 10 | 16 | 25 | 50 | 100 | 200 | 6.3 | 10 | 16 | 25 | 50 | 100 | 200 | 6.3 | 10 | 16 | 25 | 50 | 100 | 200 | 500 |
| Cap (pF) | 100 | | | | | | | | | | | | | | | | | | | | | | | | | |
| | 150 | | | | | | | | | | | | | | | | | | | | | | | | | |
| | 220 | | | C | | | | | | | | | | | | | | | | | | | | | | |
| | 330 | | | C | | | | | G | G | G | | J | J | J | J | J | J | | | | | | | | K |
| | 470 | | | C | | | | | G | G | G | | J | J | J | J | J | J | | | | | | | | K |
| | 680 | | | C | | | | | G | G | G | | J | J | J | J | J | J | | | | | | | | K |
| | 1000 | | | C | | | | | G | G | G | | J | J | J | J | J | J | | | | | | | | K |
| | 1500 | | | C | | | | | G | G | | | J | J | J | J | J | J | | J | J | J | J | J | J | M |
| | 2200 | | | C | | | | | G | G | | | J | J | J | J | J | J | | J | J | J | J | J | J | M |
| | 3300 | | | C | C | | | | G | G | | | J | J | J | J | J | J | | J | J | J | J | J | J | M |
| | 4700 | | | C | C | | | | G | G | | | J | J | J | J | J | J | | J | J | J | J | J | J | M |
| | 6800 | | | C | C | | | | G | G | | | J | J | J | J | J | J | | J | J | J | J | J | J | P |
| Cap (µF) | 0.010 | | | C | C | | | | G | G | G | | J | J | J | J | J | J | | J | J | J | J | J | J | P |
| | 0.015 | | | C | | | | | G | G | | | J | J | J | J | J | J | | J | J | J | J | J | J | M |
| | 0.022 | | | C | | | | | G | G | | | J | J | J | J | J | J | | J | J | J | J | J | J | M |
| | 0.033 | | | C | | | | | G | G | | | J | J | J | J | J | N | | J | J | J | J | J | J | M |
| | 0.047 | | | | | | | | G | G | G | | J | J | J | J | J | N | | J | J | J | J | J | J | M |
| | 0.068 | | | | | | | | G | G | G | | J | J | J | J | J | N | | J | J | J | J | J | J | P |
| | 0.10 | | | C* | | | | | G | G | G | | J | J | J | J | J | N | | J | J | J | J | J | J | P |
| | 0.15 | | | | | | | | G | G | | | J | J | J | J | N | N | | J | J | J | J | J | J | Q |
| | 0.22 | | | | | | | | G | G | | | J | J | J | N | N | N | | J | J | J | J | J | J | Q |
| | 0.33 | | | | | | | | | | | | N | N | N | N | N | N | | J | J | M | P | Q | Q | |
| | 0.47 | | | | | | | | J* | | | | N | N | N | N | N | N | | M | M | M | P | Q | Q | |
| | 0.68 | | | | | | | | | | | | N | N | N | N | N | N | | M | M | Q | Q | Q | Q | |
| | 1.0 | | | | | | | | J* | J* | | | N | N | N* | | | | | M | M | Q | Q | Q | Q | |
| | 1.5 | | | | | | | | | | | | | | | | | | | P | Q | Q | Q | | | |
| | 2.2 | | | | | | | | J* | | | | | | | | | | | | Q | Q | Q | | | |
| | 3.3 | | | | | | | | | | | | | | | | | | | | Q* | Q* | Q* | | | |
| | 4.7 | | | | | | | | | | | | | | | | | | | | Q* | Q* | Q* | | | |
| | 10 | | | | | | | | | | | | | | | | | | | | Q* | Q* | Q | | | |
| | 22 | | | | | | | | | | | | | | | | | | | | Q* | | | | | |
| | 47 | | | | | | | | | | | | | | | | | | | | | | | | | |
| | 100 | | | | | | | | | | | | | | | | | | | | | | | | | |
| WVDC | | 16 | 25 | 50 | 6.3 | 10 | 16 | 25 | 50 | 100 | 200 | 6.3 | 10 | 16 | 25 | 50 | 100 | 200 | 6.3 | 10 | 16 | 25 | 50 | 100 | 200 | 500 |
| SIZE | LD02 | | | LD03 | | | | | | LD05 | | | | | | LD06 | | | | | | | | | | |

| Letter | A | C | E | G | J | K | M | N | P | Q | X | Y | Z |
|----------------|-----------------|-----------------|-----------------|-----------------|-----------------|-----------------|-----------------|-----------------|-----------------|-----------------|-----------------|-----------------|-----------------|
| Max. Thickness | 0.33 (0.013) | 0.56 (0.022) | 0.71 (0.028) | 0.90 (0.035) | 0.94 (0.037) | 1.02 (0.040) | 1.27 (0.050) | 1.40 (0.055) | 1.52 (0.060) | 1.78 (0.070) | 2.29 (0.090) | 2.54 (0.100) | 2.79 (0.110) |
| | PAPER | | | | | EMBOSSSED | | | | | | | |

= Under Development



The Important Information/Disclaimer is incorporated in the catalog where these specifications came from or available online at www.avx.com/disclaimer/ by reference and should be reviewed in full before placing any order.

MLCC Tin/Lead Termination "B"

X7R – Capacitance Range

PREFERRED SIZES ARE SHADED

| SIZE | LD10 | | | | | | | | LD12 | | | | LD13 | | LD20 | | | | LD14 | |
|--------------|--------------------------------|----|----|----|-----|-----|-----|----|--------------------------------|-----|-----|----|--------------------------------|----|--------------------------------|-----|-----|----|--------------------------------|---|
| Soldering | Reflow Only | | | | | | | | Reflow Only | | | | Reflow Only | | Reflow Only | | | | Reflow Only | |
| Packaging | Paper/Embossed | | | | | | | | All Embossed | | | | All Embossed | | All Embossed | | | | All Embossed | |
| (L) Length | 3.20 ± 0.20 (0.126 ± 0.008) | | | | | | | | 4.50 ± 0.30 (0.177 ± 0.012) | | | | 4.50 ± 0.30 (0.177 ± 0.012) | | 5.70 ± 0.50 (0.224 ± 0.020) | | | | 5.72 ± 0.25 (0.225 ± 0.010) | |
| (W) Width | 2.50 ± 0.20 (0.098 ± 0.008) | | | | | | | | 3.20 ± 0.20 (0.126 ± 0.008) | | | | 6.40 ± 0.40 (0.252 ± 0.016) | | 5.00 ± 0.40 (0.197 ± 0.016) | | | | 6.35 ± 0.25 (0.250 ± 0.010) | |
| (t) Terminal | 0.50 ± 0.25 (0.020 ± 0.010) | | | | | | | | 0.61 ± 0.36 (0.024 ± 0.014) | | | | 0.61 ± 0.36 (0.024 ± 0.014) | | 0.64 ± 0.39 (0.025 ± 0.015) | | | | 0.64 ± 0.39 (0.025 ± 0.015) | |
| WVDC | 10 | 16 | 25 | 50 | 100 | 200 | 500 | 50 | 100 | 200 | 500 | 50 | 100 | 25 | 50 | 100 | 200 | 50 | 100 | |
| Cap (pF) | 100 | | | | | | | | | | | | | | | | | | | |
| | 150 | | | | | | | | | | | | | | | | | | | |
| | 220 | | | | | | | | | | | | | | | | | | | |
| | 330 | | | | | | | | | | | | | | | | | | | |
| | 470 | | | | | | | | | | | | | | | | | | | |
| | 680 | | | | | | | | | | | | | | | | | | | |
| | 1000 | | | | | | | | | | | | | | | | | | | |
| | 1500 | J | J | J | J | J | J | M | | | | | | | | | | | | |
| | 2200 | J | J | J | J | J | J | M | | | | | | | | | | | | |
| | 3300 | J | J | J | J | J | J | M | | | | | | | | | | | | |
| | 4700 | J | J | J | J | J | J | M | | | | | | | | | | | | |
| | 6800 | J | J | J | J | J | J | M | | | | | | | | | | | | |
| Cap (µF) | 0.010 | J | J | J | J | J | J | M | K | K | K | K | M | M | | X | X | X | M | P |
| | 0.015 | J | J | J | J | J | J | P | K | K | K | P | M | M | | X | X | X | M | P |
| | 0.022 | J | J | J | J | J | J | Q | K | K | K | P | M | M | | X | X | X | M | P |
| | 0.033 | J | J | J | J | J | J | Q | K | K | K | X | M | M | | X | X | X | M | P |
| | 0.047 | J | J | J | J | J | J | | K | K | K | Z | M | M | | X | X | X | M | P |
| | 0.068 | J | J | J | J | J | M | | K | K | K | Z | M | M | | X | X | X | M | P |
| | 0.10 | J | J | J | J | J | M | | K | K | K | Z | M | M | | X | X | X | M | P |
| | 0.15 | J | J | J | J | M | Z | | K | K | P | | M | M | | X | X | X | M | P |
| | 0.22 | J | J | J | J | P | Z | | K | K | P | | M | M | | X | X | X | M | P |
| | 0.33 | J | J | J | J | Q | | | K | M | X | | M | M | | X | X | X | M | P |
| | 0.47 | M | M | M | M | Q | | | K | P | | | M | M | | X | X | X | M | P |
| | 0.68 | M | M | P | X | X | | | M | Q | | | M | P | | X | X | X | M | P |
| | 1.0 | N | N | P | X | Z | | | M | X | | | M | P | | X | X | | M | P |
| | 1.5 | N | N | Z | Z | Z | | | Z | Z | | | M | | | X | X | | M | X |
| | 2.2 | X | X | Z | Z | Z | | | Z | Z | | | | | | X | X | | M | |
| | 3.3 | X | X | Z | Z | | | | Z | | | | | | | X | Z | | | |
| | 4.7 | X | X | Z | Z | | | | Z | Z | | | | | | X | Z | | | |
| | 10 | Z | Z | Z | Z | | | | | | | | | | | Z | Z | | | |
| | 22 | Z | Z | | | | | | | | | | | | Z | | | | | |
| | 47 | | | | | | | | | | | | | | | | | | | |
| | 100 | | | | | | | | | | | | | | | | | | | |
| WVDC | 10 | 16 | 25 | 50 | 100 | 200 | 500 | 50 | 100 | 200 | 500 | 50 | 100 | 25 | 50 | 100 | 200 | 50 | 100 | |

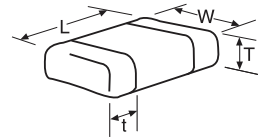

| Letter | A | C | E | G | J | K | M | N | P | Q | X | Y | Z |
|----------------|-----------------|-----------------|-----------------|-----------------|-----------------|-----------------|-----------------|-----------------|-----------------|-----------------|-----------------|-----------------|-----------------|
| Max. Thickness | 0.33 (0.013) | 0.56 (0.022) | 0.71 (0.028) | 0.90 (0.035) | 0.94 (0.037) | 1.02 (0.040) | 1.27 (0.050) | 1.40 (0.055) | 1.52 (0.060) | 1.78 (0.070) | 2.29 (0.090) | 2.54 (0.100) | 2.79 (0.110) |
| | PAPER | | | | | EMBOSSSED | | | | | | | |

MLCC Tin/Lead Termination "B"

X5R – General Specifications

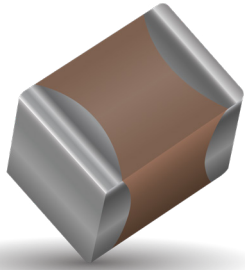

AVX Corporation will support those customers for commercial and military Multilayer Ceramic Capacitors with a termination consisting of 5% minimum lead. This termination is indicated by the use of a "B" in the 12th position of the AVX Catalog Part Number. This fulfills AVX's commitment to providing a full range of products to our customers. AVX has provided in the following pages a full range of values that we are currently offering in this special "B" termination. Please contact the factory if you require additional information on our MLCC Tin/Lead Termination "B" products.

Not RoHS Compliant

PART NUMBER (SEE PAGE 4 FOR COMPLETE PART NUMBER EXPLANATION)

| LD05 | 5 | D | 101 | J | A | B | 2 | A |
|---|---|-------------------|---------------------------------|---|---------------------|--|--|---------------------|
| Size | Voltage | Dielectric | Capacitance Code (In pF) | Capacitance Tolerance | Failure Rate | Terminations | Packaging | Special Code |
| LD02 - 0402 LD03 - 0603 LD04 - 0504* LD05 - 0805 LD06 - 1206 LD10 - 1210 LD12 - 1812 LD13 - 1825 LD14 - 2225 LD20 - 2220 | 6.3V = 6 10V = Z 16V = Y 25V = 3 35V = D 50V = 5 100V = 1 200V = 2 500V = 7 | X5R = D | 2 Sig. Digits + Number of Zeros | B = ±10 pF (<10pF) C = ±25 pF (<10pF) D = ±50 pF (<10pF) F = ±1% (≥ 10 pF) G = ±2% (≥ 10 pF) J = ±5% K = ±10% M = ±20% | A = Not Applicable | B = 5% min lead X = FLEXITERM® with 5% min lead** **X7R only | 2 = 7" Reel 4 = 13" Reel Contact Factory For Multiples* | A = Std. Product |

*LD04 has the same CV ranges as LD03.

See FLEXITERM® section for CV options

NOTE: Contact factory for availability of Tolerance Options for Specific Part Numbers. Contact factory for non-specified capacitance values.

TYPICAL ELECTRICAL CHARACTERISTICS

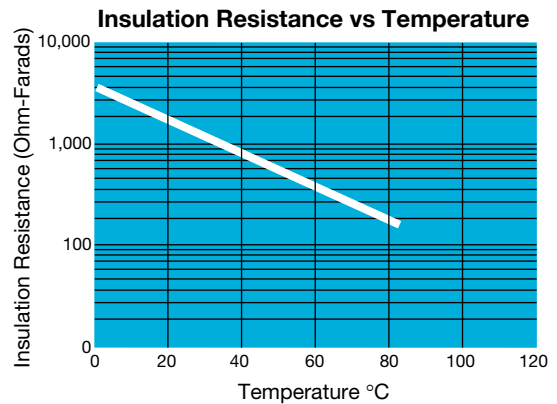
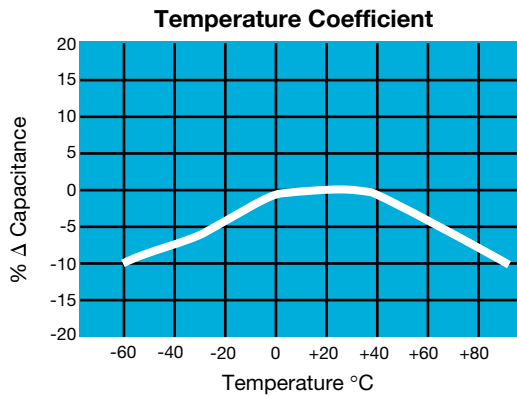

MLCC Tin/Lead Termination "B"

X5R – Specifications and Test Methods

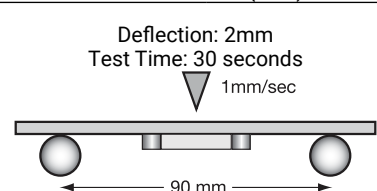
| Parameter/Test | | X5R Specification Limits | Measuring Conditions | |
|--------------------------------|-----------------------|---|---|----------------|
| Operating Temperature Range | | -55°C to +85°C | Temperature Cycle Chamber | |
| Capacitance | | Within specified tolerance | Freq.: 1.0 kHz ± 10% Voltage: 1.0Vrms ± .2V For Cap > 10 µF, 0.5Vrms @ 120Hz | |
| Dissipation Factor | | ≤ 2.5% for ≥ 50V DC rating ≤ 3.0% for 25V, 35V DC rating ≤ 12.5% Max. for 16V DC rating and lower Contact Factory for DF by PN | | |
| Insulation Resistance | | 10,000MΩ or 500MΩ - µF, whichever is less | Charge device with rated voltage for 120 ± 5 secs @ room temp/humidity | |
| Dielectric Strength | | No breakdown or visual defects | Charge device with 250% of rated voltage for 1-5 seconds, w/charge and discharge current limited to 50 mA (max) | |
| Resistance to Flexure Stresses | Appearance | No defects |  | |
| | Capacitance Variation | ≤ ±12% | | |
| | Dissipation Factor | Meets Initial Values (As Above) | | |
| | Insulation Resistance | ≥ Initial Value x 0.3 | | |
| Solderability | | ≥ 95% of each terminal should be covered with fresh solder | Dip device in eutectic solder at 230 ± 5°C for 5.0 ± 0.5 seconds | |
| Resistance to Solder Heat | Appearance | No defects, <25% leaching of either end terminal | Dip device in eutectic solder at 260°C for 60 seconds. Store at room temperature for 24 ± 2 hours before measuring electrical properties. | |
| | Capacitance Variation | ≤ ±7.5% | | |
| | Dissipation Factor | Meets Initial Values (As Above) | | |
| | Insulation Resistance | Meets Initial Values (As Above) | | |
| | Dielectric Strength | Meets Initial Values (As Above) | | |
| Thermal Shock | Appearance | No visual defects | Step 1: -55°C ± 2° | 30 ± 3 minutes |
| | Capacitance Variation | ≤ ±7.5% | Step 2: Room Temp | ≤ 3 minutes |
| | Dissipation Factor | Meets Initial Values (As Above) | Step 3: +85°C ± 2° | 30 ± 3 minutes |
| | Insulation Resistance | Meets Initial Values (As Above) | Step 4: Room Temp | ≤ 3 minutes |
| | Dielectric Strength | Meets Initial Values (As Above) | Repeat for 5 cycles and measure after 24 ± 2 hours at room temperature | |
| Load Life | Appearance | No visual defects | Charge device with 1.5X rated voltage in test chamber set at 85°C ± 2°C for 1000 hours (+48, -0). Note: Contact factory for *optional specification part numbers that are tested at < 1.5X rated voltage. Remove from test chamber and stabilize at room temperature for 24 ± 2 hours before measuring. | |
| | Capacitance Variation | ≤ ±12.5% | | |
| | Dissipation Factor | ≤ Initial Value x 2.0 (See Above) | | |
| | Insulation Resistance | ≥ Initial Value x 0.3 (See Above) | | |
| | Dielectric Strength | Meets Initial Values (As Above) | | |
| Load Humidity | Appearance | No visual defects | Store in a test chamber set at 85°C ± 2°C/ 85% ± 5% relative humidity for 1000 hours (+48, -0) with rated voltage applied. Remove from chamber and stabilize at room temperature and humidity for 24 ± 2 hours before measuring. | |
| | Capacitance Variation | ≤ ±12.5% | | |
| | Dissipation Factor | ≤ Initial Value x 2.0 (See Above) | | |
| | Insulation Resistance | ≥ Initial Value x 0.3 (See Above) | | |
| | Dielectric Strength | Meets Initial Values (As Above) | | |

MLCC Tin/Lead Termination “B”

X5R – Capacitance Range



PREFERRED SIZES ARE SHADED

| SIZE | LD02 | LD03 | LD05 | LD06 | LD10 | LD12 |
|--------------|--|---|---|---|---|--------------|
| Soldering | Reflow/Wave | Reflow/Wave | Reflow/Wave | Reflow/Wave | Reflow/Wave | |
| Packaging | All Paper | All Paper | Paper/Embossed | Paper/Embossed | Paper/Embossed | |
| (L) Length | mm (in.) 1.00 ± 0.10 (0.040 ± 0.004) | mm (in.) 1.60 ± 0.15 (0.063 ± 0.006) | mm (in.) 2.01 ± 0.20 (0.079 ± 0.008) | mm (in.) 3.20 ± 0.20 (0.126 ± 0.008) | mm (in.) 3.20 ± 0.20 (0.126 ± 0.008) | |
| (W) Width | mm (in.) 0.50 ± 0.10 (0.020 ± 0.004) | mm (in.) 0.81 ± 0.15 (0.032 ± 0.006) | mm (in.) 1.25 ± 0.20 (0.049 ± 0.008) | mm (in.) 1.60 ± 0.20 (0.063 ± 0.008) | mm (in.) 2.50 ± 0.20 (0.098 ± 0.008) | |
| (t) Terminal | mm (in.) 0.25 ± 0.15 (0.010 ± 0.006) | mm (in.) 0.35 ± 0.15 (0.014 ± 0.006) | mm (in.) 0.50 ± 0.25 (0.020 ± 0.010) | mm (in.) 0.50 ± 0.25 (0.020 ± 0.010) | mm (in.) 0.50 ± 0.25 (0.020 ± 0.010) | |
| WVDC | 4 6.3 10 16 25 50 | 4 6.3 10 16 25 35 50 | 6.3 10 16 25 35 50 | 6.3 10 16 25 35 50 | 4 6.3 10 16 25 35 50 | 6.3 10 25 50 |
| Cap (pF) | 100 150 220 330 470 680 | | | | | |
| Cap (µF) | 0.010 0.015 0.022 0.033 0.047 0.068 | | | | | |
| Cap (µF) | 0.10 0.15 0.22 0.33 0.47 0.68 | | | | | |
| Cap (µF) | 1.0 1.5 2.2 | | | | | |
| Cap (µF) | 3.3 4.7 10 | | | | | |
| Cap (µF) | 22 47 100 | | | | | |
| WVDC | 4 6.3 10 16 25 50 | 4 6.3 10 16 25 35 50 | 6.3 10 16 25 35 50 | 6.3 10 16 25 35 50 | 4 6.3 10 16 25 35 50 | 6.3 10 25 50 |
| SIZE | LD02 | LD03 | LD05 | LD06 | LD10 | LD12 |

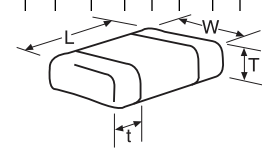

| Letter | A | C | E | G | J | K | M | N | P | Q | X | Y | Z |
|----------------|-----------------|-----------------|-----------------|-----------------|-----------------|-----------------|-----------------|-----------------|-----------------|-----------------|-----------------|-----------------|-----------------|
| Max. Thickness | 0.33 (0.013) | 0.56 (0.022) | 0.71 (0.028) | 0.90 (0.035) | 0.94 (0.037) | 1.02 (0.040) | 1.27 (0.050) | 1.40 (0.055) | 1.52 (0.060) | 1.78 (0.070) | 2.29 (0.090) | 2.54 (0.100) | 2.79 (0.110) |
| | PAPER | | | | | EMBOSSSED | | | | | | | |

*Optional Specifications – Contact factory

NOTE: Contact factory for non-specified capacitance values

Automotive MLCC

General Specifications

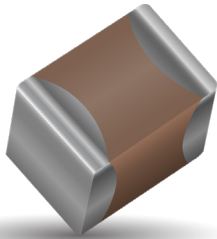

GENERAL DESCRIPTION

AVX Corporation has supported the Automotive Industry requirements for Multilayer Ceramic Capacitors consistently for more than 25 years. Products have been developed and tested specifically for automotive applications and all manufacturing facilities are QS9000 and VDA 6.4 approved.

AVX is using AECQ200 as the qualification vehicle for this transition. A detailed qualification package is available on request and contains results on a range of part numbers.

HOW TO ORDER

| | | | | | | | | |
|---|---|--|--|--|---|--|---|--|
| 0805 | 5 | A | 104 | K | 4 | T | 2 | A |
| Size 0402 0603 0805 1206 1210 1812 | Voltage 6.3V = 6 10V = Z 16V = Y 25V = 3 35V = D 50V = 5 100V = 1 200V = 2 500V = 7 | Dielectric NP0 = A X7R = C X8R = F | Capacitance Code (In pF) 2 Sig. Digits + Number of Zeros e.g. 10 F = 106 | Capacitance Tolerance F = $\pm 1\%$ ($\geq 10\text{pF}$)* G = $\pm 2\%$ ($\geq 10\text{pF}$)* J = $\pm 5\%$ ($\leq 1\mu\text{F}$) K = $\pm 10\%$ M = $\pm 20\%$ *NPO only | Failure Rate 4=Automotive | Terminations T = Plated Ni and Sn Z = FLEXITERM®** U = Conductive Epo **X7R X8R only | Packaging 2 = 7" Reel 4 = 13" Reel | Special Code A = Std.Product |

Contact factory for availability of Tolerance Options for Specific Part Numbers.

NOTE: Contact factory for non-specified capacitance values
0402 case size available in T termination only.

COMMERCIAL VS AUTOMOTIVE MLCC PROCESS COMPARISON

| | Commercial | Automotive |
|--|--|---|
| Administrative | Standard Part Numbers. No restriction on who purchases these parts. | Specific Automotive Part Number. Used to control supply of product to Automotive customers. |
| Design | Minimum ceramic thickness of 0.020" | Minimum Ceramic thickness of 0.029" (0.74mm) on all X7R product. |
| Dicing | Side & End Margins = 0.003" min | Side & End Margins = 0.004" min Cover Layers = 0.003" min |
| Lot Qualification (Destructive Physical Analysis - DPA) | As per EIA RS469 | Increased sample plan stricter criteria. |
| Visual/Cosmetic Quality | Standard process and inspection | 100% inspection |
| Application Robustness | Standard sampling for accelerated wave solder on X7R dielectrics | Increased sampling for accelerated wave solder on X7R and NP0 followed by lot by lot reliability testing. |

All Tests have Accept/Reject Criteria 0/1

Automotive MLCC

NP0/X7R Dielectric

FLEXITERM FEATURES

- a) Bend Test
The capacitor is soldered to the PC Board as shown:

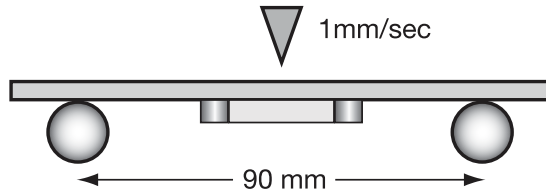

Typical bend test results are shown below:

| Style | Conventional | Soft Term |
|-------|--------------|-----------|
| 0603 | >2mm | >5 |
| 0805 | >2mm | >5 |
| 1206 | >2mm | >5 |

- a) Temperature Cycle testing
FLEXITERM[®] has the ability to withstand at least 1000 cycles between -55°C and +125°C

Automotive MLCC-NP0

Capacitance Range



| SIZE | | 0402 | | 0603 | | | | 0805 | | | | | 1206 | | | | | |
|-----------|------|-------------|-----|-------------|-----|------|------|-------------|-----|------|------|------|-------------|-----|------|------|------|------|
| Soldering | WVDC | Reflow/Wave | | Reflow/Wave | | | | Reflow/Wave | | | | | Reflow/Wave | | | | | |
| | | 25V | 50V | 25V | 50V | 100V | 200V | 25V | 50V | 100V | 200V | 250V | 25V | 50V | 100V | 200V | 250V | 500V |
| 0R5 | 0.5 | C | C | G | G | G | G | J | J | J | N | N | J | J | J | J | J | J |
| 1R0 | 1.0 | C | C | G | G | G | G | J | J | J | N | N | J | J | J | J | J | J |
| 1R2 | 1.2 | C | C | G | G | G | G | J | J | J | N | N | J | J | J | J | J | J |
| 1R5 | 1.5 | C | C | G | G | G | G | J | J | J | N | N | J | J | J | J | J | J |
| 1R8 | 1.8 | C | C | G | G | G | G | J | J | J | N | N | J | J | J | J | J | J |
| 2R2 | 2.2 | C | C | G | G | G | G | J | J | J | N | N | J | J | J | J | J | J |
| 2R7 | 2.7 | C | C | G | G | G | G | J | J | J | N | N | J | J | J | J | J | J |
| 3R3 | 3.3 | C | C | G | G | G | G | J | J | J | N | N | J | J | J | J | J | J |
| 3R9 | 3.9 | C | C | G | G | G | G | J | J | J | N | N | J | J | J | J | J | J |
| 4R7 | 4.7 | C | C | G | G | G | G | J | J | J | N | N | J | J | J | J | J | J |
| 5R6 | 5.6 | C | C | G | G | G | G | J | J | J | N | N | J | J | J | J | J | J |
| 6R8 | 6.8 | C | C | G | G | G | G | J | J | J | N | N | J | J | J | J | J | J |
| 8R2 | 8.2 | C | C | G | G | G | G | J | J | J | N | N | J | J | J | J | J | J |
| 100 | 10.0 | C | C | G | G | G | G | J | J | J | N | N | J | J | J | J | J | J |
| 120 | 12 | C | C | G | G | G | G | J | J | J | N | N | J | J | J | J | J | J |
| 150 | 15 | C | C | G | G | G | G | J | J | J | N | N | J | J | J | J | J | J |
| 180 | 18 | C | C | G | G | G | G | J | J | J | N | N | J | J | J | J | J | J |
| 220 | 22 | C | C | G | G | G | G | J | J | J | N | N | J | J | J | J | J | J |
| 270 | 27 | C | C | G | G | G | G | J | J | J | N | N | J | J | J | J | J | J |
| 330 | 33 | C | C | G | G | G | G | J | J | J | N | N | J | J | J | J | J | J |
| 390 | 39 | C | C | G | G | G | G | J | J | J | N | N | J | J | J | J | J | J |
| 470 | 47 | C | C | G | G | G | G | J | J | J | N | N | J | J | J | J | J | J |
| 510 | 51 | C | C | G | G | G | G | J | J | J | N | N | J | J | J | J | | |
| 560 | 56 | C | C | G | G | G | G | J | J | J | N | N | J | J | J | J | | |
| 680 | 68 | C | C | G | G | G | G | J | J | J | N | N | J | J | J | J | | |
| 820 | 82 | C | C | G | G | G | G | J | J | J | N | N | J | J | J | J | | |
| 101 | 100 | C | C | G | G | G | G | J | J | J | N | N | J | J | J | J | | |
| 121 | 120 | | | G | G | G | | J | J | J | N | N | J | J | J | J | | |
| 151 | 150 | | | G | G | G | | J | J | J | N | N | J | J | J | J | | |
| 181 | 180 | | | G | G | G | | J | J | J | N | N | J | J | J | J | | |
| 221 | 220 | | | G | G | G | | J | J | J | N | N | J | J | J | J | | |
| 271 | 270 | | | G | G | G | | J | J | J | N | N | J | J | J | J | | |
| 331 | 330 | | | G | G | G | | J | J | J | N | N | J | J | J | J | | |
| 391 | 390 | | | G | G | | | J | J | J | | | J | J | J | J | | |
| 471 | 470 | | | G | G | | | J | J | J | | | J | J | J | J | | |
| 561 | 560 | | | G | G | | | J | J | J | | | J | J | J | J | | |
| 681 | 680 | | | G | G | | | J | J | J | | | J | J | J | J | | |
| 821 | 820 | | | | | | | J | J | J | | | J | J | J | J | | |
| 102 | 1000 | | | | | | | J | J | J | | | J | J | J | J | | |
| 122 | 1200 | | | | | | | | | | | | | | | | | |
| 152 | 1500 | | | | | | | | | | | | | | | | | |
| 182 | 1800 | | | | | | | | | | | | | | | | | |
| 222 | 2200 | | | | | | | | | | | | | | | | | |
| 272 | 2700 | | | | | | | | | | | | | | | | | |
| 332 | 3300 | | | | | | | | | | | | | | | | | |
| 392 | 3900 | | | | | | | | | | | | | | | | | |
| 472 | 4700 | | | | | | | | | | | | | | | | | |
| 103 | 10nF | | | | | | | | | | | | | | | | | |
| WVDC | | 25V | 50V | 25V | 50V | 100V | 200V | 25V | 50V | 100V | 200V | 250V | 25V | 50V | 100V | 200V | 250V | 500V |
| Size | | 0402 | | 0603 | | | | 0805 | | | | | 1206 | | | | | |

| Letter | A | C | E | G | J | K | M | N | P | Q | X | Y | Z |
|----------------|-----------------|-----------------|-----------------|-----------------|-----------------|-----------------|-----------------|-----------------|-----------------|-----------------|-----------------|-----------------|-----------------|
| Max. Thickness | 0.33 (0.013) | 0.56 (0.022) | 0.71 (0.028) | 0.90 (0.035) | 0.94 (0.037) | 1.02 (0.040) | 1.27 (0.050) | 1.40 (0.055) | 1.52 (0.060) | 1.78 (0.070) | 2.29 (0.090) | 2.54 (0.100) | 2.79 (0.110) |
| | PAPER | | | | | EMBOSSED | | | | | | | |

Automotive MLCC - X7R

Capacitance Range



| SIZE | 0402 | | | 0603 | | | | | | 0805 | | | | | 1206 | | | | | 1210 | | | | 1812 | | | 2220 | | | | | | | |
|------|-----------|-------|-----|-------------|-----|-----|-----|------|------|-------------|-----|-----|-----|------|-------------|------|-----|-----|-----|-------------|------|------|------|-------------|-----|-----|-------------|-----|------|-----|-----|------|---|---|
| | Soldering | | | Reflow/Wave | | | | | | Reflow/Wave | | | | | Reflow/Wave | | | | | Reflow Only | | | | Reflow Only | | | Reflow Only | | | | | | | |
| WVDC | 16V | 25V | 50V | 10V | 16V | 25V | 50V | 100V | 200V | 250V | 16V | 25V | 50V | 100V | 200V | 250V | 16V | 25V | 50V | 100V | 200V | 250V | 500V | 16V | 25V | 50V | 100V | 50V | 100V | 25V | 50V | 100V | | |
| 221 | Cap | 220 | C | C | C | | | | | | | | | C | | | | | | | | | | | | | | | | | | | | |
| 271 | (pF) | 270 | C | C | C | | | | | | | | | | | | | | | | | | | | | | | | | | | | | |
| 331 | | 330 | C | C | C | | | | | | | | | | | | | | | | | | | | | | | | | | | | | |
| 391 | | 390 | C | C | C | | | | | | | | | | | | | | | | | | | | | | | | | | | | | |
| 471 | | 470 | C | C | C | | | | | | | | | | | | | | | | | | | | | | | | | | | | | |
| 561 | | 560 | C | C | C | | | | | | | | | | | | | | | | | | | | | | | | | | | | | |
| 681 | | 680 | C | C | C | | | | | | | | | | | | | | | | | | | | | | | | | | | | | |
| 821 | | 820 | C | C | C | | | | | | | | | | | | | | | | | | | | | | | | | | | | | |
| 102 | | 1000 | C | C | C | G | G | G | G | G | G | G | J | J | J | J | J | J | J | J | J | J | J | J | J | J | J | J | J | J | J | J | J | |
| 182 | | 1800 | C | C | C | G | G | G | G | G | G | G | J | J | J | J | J | J | J | J | J | J | J | J | J | J | J | J | J | J | J | J | J | J |
| 222 | | 2200 | C | C | C | G | G | G | G | G | G | G | J | J | J | J | J | J | J | J | J | J | J | J | J | J | J | J | J | J | J | J | J | J |
| 332 | | 3300 | C | C | C | G | G | G | G | G | G | G | J | J | J | J | J | J | J | J | J | J | J | J | J | J | J | J | J | J | J | J | J | J |
| 472 | | 4700 | C | C | C | G | G | G | G | G | G | G | J | J | J | J | J | J | J | J | J | J | J | J | J | J | J | J | J | J | J | J | J | J |
| 103 | Cap | 0.01 | C | C | C | G | G | G | G | G | G | G | J | J | J | J | J | J | J | J | J | J | J | J | J | J | J | J | J | J | J | J | J | |
| 123 | (F) | 0.012 | C | | | G | G | G | G | G | | | J | J | J | N | N | N | J | J | J | J | J | J | | | K | K | K | K | K | K | K | |
| 153 | | 0.015 | C | | | G | G | G | G | G | | | J | J | J | N | N | N | J | J | J | J | J | J | | | K | K | K | K | K | K | K | |
| 183 | | 0.018 | C | | | G | G | G | G | G | | | J | J | J | N | N | N | J | J | J | J | J | J | | | K | K | K | K | K | K | K | |
| 223 | | 0.022 | C | | | G | G | G | G | G | | | J | J | J | N | N | N | J | J | J | J | J | J | | | K | K | K | K | K | K | K | |
| 273 | | 0.027 | C | | | G | G | G | G | J | | | J | J | J | N | N | N | J | J | J | J | J | J | | | K | K | K | K | K | K | K | |
| 333 | | 0.033 | C | | | G | G | G | G | J | | | J | J | J | N | N | N | J | J | J | J | J | J | | | K | K | K | K | K | K | K | |
| 473 | | 0.047 | | | | G | G | G | G | J | | | J | J | J | N | N | N | J | J | J | M | M | M | | | K | K | K | K | K | K | K | |
| 563 | | 0.056 | | | | G | G | G | G | J | | | J | J | J | N | | | J | J | J | M | M | M | | | K | K | K | M | K | K | K | |
| 683 | | 0.068 | | | | G | G | G | G | J | | | J | J | J | N | | | J | J | J | M | M | M | | | K | K | K | M | K | K | K | |
| 823 | | 0.082 | | | | G | G | G | G | J | | | J | J | J | N | | | J | J | J | M | M | M | | | K | K | K | M | K | K | K | |
| 104 | | 0.1 | | | | G | G | G | G | J | | | J | J | J | N | | | J | J | J | M | P | P | | | K | K | K | M | K | K | K | |
| 124 | | 0.12 | | | | G | | | | | | | J | J | N | N | | | J | J | M | M | Q | Q | | | K | K | K | P | K | K | K | |
| 154 | | 0.15 | | | | G | | | | | | | M | N | N | N | | | J | J | M | M | Q | Q | | | K | K | K | P | K | K | K | |
| 224 | | 0.22 | | | | G | | | | | | | M | N | N | N | | | J | M | M | Q | Q | Q | | | M | M | M | P | M | M | M | |
| 334 | | 0.33 | | | | | | | | | | | N | N | N | N | | | J | M | P | Q | | | | | P | P | P | Q | X | X | X | |
| 474 | | 0.47 | | | | | | | | | | | N | N | N | N | | | M | M | P | Q | | | | | P | P | P | Q | X | X | X | |
| 684 | | 0.68 | | | | | | | | | | | N | N | N | N | | | M | Q | Q | Q | Q | | | | P | P | Q | X | X | X | X | |
| 105 | | 1 | | | | | | | | | | | N | N | N | N | | | M | Q | Q | Q | Q | | | | P | Q | Q | Z | X | X | Z | |
| 155 | | 1.5 | | | | | | | | | | | N | N | | | | | Q | Q | Q | Q | Q | | | | P | Q | Z | Z | X | X | Z | |
| 225 | | 2.2 | | | | | | | | | | | N | N | | | | | Q | Q | Q | Q | Q | | | | Z | Z | Z | Z | Z | Z | Z | |
| 335 | | 3.3 | | | | | | | | | | | | | | | | | Q | Q | Q | Q | Q | | | | X | Z | Z | Z | Z | Z | Z | |
| 475 | | 4.7 | | | | | | | | | | | | | | | | | Q | Q | Q | Q | Q | | | | X | Z | Z | Z | Z | Z | Z | |
| 106 | | 10 | | | | | | | | | | | | | | | | | | | | | | | | | Z | Z | Z | | Z | Z | Z | |
| 226 | | 22 | | | | | | | | | | | | | | | | | | | | | | | | | | Z | | | | | | |
| WVDC | 16V | 25V | 50V | 10V | 16V | 25V | 50V | 100V | 200V | 250V | 16V | 25V | 50V | 100V | 200V | 250V | 16V | 25V | 50V | 100V | 200V | 250V | 500V | 16V | 25V | 50V | 100V | 50V | 100V | 25V | 50V | 100V | | |
| Size | 0402 | | | 0603 | | | | | | 0805 | | | | | 1206 | | | | | 1210 | | | | 1812 | | | 2220 | | | | | | | |

| Letter | A | C | E | G | J | K | M | N | P | Q | X | Y | Z |
|----------------|-----------------|-----------------|-----------------|-----------------|-----------------|-----------------|-----------------|-----------------|-----------------|-----------------|-----------------|-----------------|-----------------|
| Max. Thickness | 0.33 (0.013) | 0.56 (0.022) | 0.71 (0.028) | 0.90 (0.035) | 0.94 (0.037) | 1.02 (0.040) | 1.27 (0.050) | 1.40 (0.055) | 1.52 (0.060) | 1.78 (0.070) | 2.29 (0.090) | 2.54 (0.100) | 2.79 (0.110) |
| | PAPER | | | | | EMBOSSED | | | | | | | |



The Important Information/Disclaimer is incorporated in the catalog where these specifications came from or available online at www.avx.com/disclaimer/ by reference and should be reviewed in full before placing any order.

Automotive MLCC - X8R

Capacitance Range



| SIZE | | 0603 | | 0805 | | 1206 | |
|-----------|-----------|-------------|-----|-------------|-----|-------------|-----|
| Soldering | | Reflow/Wave | | Reflow/Wave | | Reflow/Wave | |
| WVDC | WVDC | 25V | 50V | 25V | 50V | 25V | 50V |
| 271 | Cap 270 | G | G | | | | |
| 331 | (pF) 330 | G | G | J | J | | |
| 471 | 470 | G | G | J | J | | |
| 681 | 680 | G | G | J | J | | |
| 102 | 1000 | G | G | J | J | J | J |
| 152 | 1500 | G | G | J | J | J | J |
| 182 | 1800 | G | G | J | J | J | J |
| 222 | 2200 | G | G | J | J | J | J |
| 272 | 2700 | G | G | J | J | J | J |
| 332 | 3300 | G | G | J | J | J | J |
| 392 | 3900 | G | G | J | J | J | J |
| 472 | 4700 | G | G | J | J | J | J |
| 562 | 5600 | G | G | J | J | J | J |
| 682 | 6800 | G | G | J | J | J | J |
| 822 | 8200 | G | G | J | J | J | J |
| 103 | Cap 0.01 | G | G | J | J | J | J |
| 123 | (F) 0.012 | G | G | J | J | J | J |
| 153 | 0.015 | G | G | J | J | J | J |
| 183 | 0.018 | G | G | J | J | J | J |
| 223 | 0.022 | G | G | J | J | J | J |
| 273 | 0.027 | G | G | J | J | J | J |
| 333 | 0.033 | G | G | J | J | J | J |
| 393 | 0.039 | G | G | J | J | J | J |
| 473 | 0.047 | G | G | J | J | J | J |
| 563 | 0.056 | G | | N | N | M | M |
| 683 | 0.068 | G | | N | N | M | M |
| 823 | 0.082 | | | N | N | M | M |
| 104 | 0.1 | | | N | N | M | M |
| 124 | 0.12 | | | N | N | M | M |
| 154 | 0.15 | | | N | N | M | M |
| 184 | 0.18 | | | N | | M | M |
| 224 | 0.22 | | | N | | M | M |
| 274 | 0.27 | | | | | M | M |
| 334 | 0.33 | | | | | M | M |
| 394 | 0.39 | | | | | M | |
| 474 | 0.47 | | | | | M | |
| 684 | 0.68 | | | | | | |
| 824 | 0.82 | | | | | | |
| 105 | 1 | | | | | | |
| WVDC | WVDC | 25V | 50V | 25V | 50V | 25V | 50V |
| SIZE | | 0603 | | 0805 | | 1206 | |

| Letter | A | C | E | G | J | K | M | N | P | Q | X | Y | Z |
|----------------|-----------------|-----------------|-----------------|-----------------|-----------------|-----------------|-----------------|-----------------|-----------------|-----------------|-----------------|-----------------|-----------------|
| Max. Thickness | 0.33 (0.013) | 0.56 (0.022) | 0.71 (0.028) | 0.90 (0.035) | 0.94 (0.037) | 1.02 (0.040) | 1.27 (0.050) | 1.40 (0.055) | 1.52 (0.060) | 1.78 (0.070) | 2.29 (0.090) | 2.54 (0.100) | 2.79 (0.110) |
| | PAPER | | | | | EMBOSSSED | | | | | | | |

APS for COTS+ High Reliability Applications

General Specifications Surface Mount NP0, X7R and X8R/L MLCCs

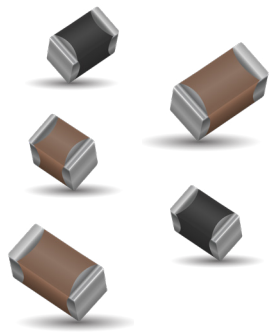

AVX's APS COTS+ series of multilayer ceramic capacitors offers the customer a high reliability solution with an ultralow failure rate, <1ppb, in a variety of case sizes and voltages. The APS range encompasses a wide range of dielectric types to meet the customer's requirements from low temperature/voltage capacitance change dielectric, NP0, to high preforming capacitance voltage X7R to high temperature reliability dielectrics, X8R/L.

APS capacitors have a wider capacitance range than MIL spec parts that satisfies the need for higher CV demands and board space saving requirements. Each production lot is extensively tested and removes the requirement for customer specific drawings. The testing regime uses many of the MIL-STD test methods as per MIL-PRF-55681 and has a field failure rate of less than 1 ppb. The APS testing series uses AVX's unique in-house maverick testing detection system that eliminates infant mortality failures.

Applications suitable for APS include Industrial, Telecommunications, Aviation, and Military. The APS is available with a range of different termination finishes, Flexiterm®, Nickel / Tin and Tin with Pb1. Flexiterm® technology delivers improved thermo-mechanical stress resistance.

AVX'S APS RELIABILITY TEST SUMMARY

- 100% Visual Inspection
- DPA
- IR, DF, Cap, DWV
- Maverick Lot Review
- Thermal Shock
- 85/85 Testing
- Additional Life Testing
- C of C with every Order
- Quarterly Data Package

FEATURES

- The APS range has been extensively reliability tested as standard resulting in an ultralow failure rate, ≤1ppb
- The APS range is available with Flexiterm® that deliver's high thermo-mechanical stress resistance.
- High CV range enabling board space saving requirements.

| Dielectric | Temperature/Percentage Cap Change |
|------------|-----------------------------------|
| NP0 | -30ppm +30ppm from -55°C + 125°C |
| X7R | -15% +15% from -55°C to + 125°C |
| X8R | -15% +15% from -55°C to + 150°C |
| X8L | -15% +40% from -55°C to + 150°C |

HOW TO ORDER

| | | | | | | | | |
|--|--|--|---|---------------------------------|--------------|---|-----------------------------|-----------------|
| AP03 | 5 | A | 104 | K | Q | T | 2 | A |
| Size | Voltage | Dielectric | Capacitance Code (In pF) | Capacitance Tolerance | Failure Rate | Terminations | Packaging | Special Code |
| AP03=0603 AP05=0805 AP06=1206 AP10=1210 AP12=1812 AP20=2220 | 10V = Z 16V = Y 25V = 3 50V = 5 100V = 1 200V = 2 250V = V 500V = 7 | NP0 = A X7R = C X8R = F X8L = L | 2 Sig. Digits + Number of Zeros e.g. 10 F = 106 | J = ±5% K = ±10% M = ±20% | Q = APS | T = Plated Ni and Sn Z = FLEXITERM®** B = 10% min lead X = FLEXITERM® with 10% min lead Z,X for X7R only **RoHS compliant | 2 = 7" Reel 4 = 13" Reel | A = Std.Product |

NOTE: Contact factory for availability of Termination and Tolerance Options for Specific Part Number.

APS COTS+ NP0 Series

Capacitance Range



| Size | AP03 = 0603 | | | AP05 = 0805 | | | AP06 = 1206 | | | | | AP10 = 1210 | | | | |
|----------|-------------|-----|------|-------------|-----|------|-------------|-----|------|------|------|-------------|-----|------|------|------|
| | WVDC | 25V | 50V | 100V | 25V | 50V | 100V | 25V | 50V | 100V | 200V | 500V | 25V | 50V | 100V | 200V |
| 100 10pF | G | G | G | J | J | J | J | J | J | J | J | J | | | | |
| 120 12 | G | G | G | J | J | J | J | J | J | J | J | J | | | | |
| 150 15 | G | G | G | J | J | J | J | J | J | J | J | J | | | | |
| 180 18 | G | G | G | J | J | J | J | J | J | J | J | J | | | | |
| 220 22 | G | G | G | J | J | J | J | J | J | J | J | J | | | | |
| 270 27 | G | G | G | J | J | J | J | J | J | J | J | J | | | | |
| 330 33 | G | G | G | J | J | J | J | J | J | J | J | J | | | | |
| 390 39 | G | G | G | J | J | J | J | J | J | J | J | J | | | | |
| 470 47 | G | G | G | J | J | J | J | J | J | J | J | J | | | | |
| 510 51 | G | G | G | J | J | J | J | J | J | J | J | J | | | | |
| 560 56 | G | G | G | J | J | J | J | J | J | J | J | J | | | | |
| 680 68 | G | G | G | J | J | J | J | J | J | J | J | J | | | | |
| 820 82 | G | G | G | J | J | J | J | J | J | J | J | J | | | | |
| 101 100 | G | G | G | J | J | J | J | J | J | J | J | J | | | | |
| 121 120 | G | G | G | J | J | J | J | J | J | J | J | J | | | | |
| 151 150 | G | G | G | J | J | J | J | J | J | J | J | J | | | | |
| 181 180 | G | G | G | J | J | J | J | J | J | J | J | J | | | | |
| 221 220 | G | G | G | J | J | J | J | J | J | J | J | J | | | | |
| 271 270 | G | G | G | J | J | J | J | J | J | J | J | J | | | | |
| 331 330 | G | G | G | J | J | J | J | J | J | J | J | J | | | | |
| 391 390 | G | G | | J | J | J | J | J | J | J | J | J | | | | |
| 471 470 | G | G | | J | J | J | J | J | J | J | J | J | | | | |
| 561 560 | | | | J | J | J | J | J | J | J | J | J | | | | |
| 681 680 | | | | J | J | J | J | J | J | J | J | J | | | | |
| 821 820 | | | | J | J | J | J | J | J | J | J | J | | | | |
| 102 1000 | | | | J | J | J | J | J | J | J | J | J | J | J | J | J |
| 122 1200 | | | | | | | | | | | | | J | J | M | M |
| 152 1500 | | | | | | | | | | | | | J | J | M | M |
| 182 1800 | | | | | | | | | | | | | J | J | M | M |
| 222 2200 | | | | | | | | | | | | | J | J | M | M |
| 272 2700 | | | | | | | | | | | | | | | | |
| 332 3300 | | | | | | | | | | | | | | | | |
| 392 3900 | | | | | | | | | | | | | | | | |
| 472 4700 | | | | | | | | | | | | | | | | |
| 103 10nF | | | | | | | | | | | | | | | | |
| WVDC | 25V | 50V | 100V | 25V | 50V | 100V | 25V | 50V | 100V | 200V | 500V | 25V | 50V | 100V | 200V | |
| Size | AP03 = 0603 | | | AP05 = 0805 | | | AP06 = 1206 | | | | | AP10 = 1210 | | | | |



| Letter | A | C | E | G | J | K | M | N | P | Q | X | Y | Z |
|----------------|-----------------|-----------------|-----------------|-----------------|-----------------|-----------------|-----------------|-----------------|-----------------|-----------------|-----------------|-----------------|-----------------|
| Max. Thickness | 0.33 (0.013) | 0.56 (0.022) | 0.71 (0.028) | 0.90 (0.035) | 0.94 (0.037) | 1.02 (0.040) | 1.27 (0.050) | 1.40 (0.055) | 1.52 (0.060) | 1.78 (0.070) | 2.29 (0.090) | 2.54 (0.100) | 2.79 (0.110) |
| | PAPER | | | | | EMBOSSSED | | | | | | | |

TS 16949, ISO 9001 Certified



APS COTS+ X7R Series

Capacitance Range



| Size | AP03 = 0603 | | | | | AP05 = 0805 | | | | | AP06 = 1206 | | | | | AP10 = 1210 | | | | AP12 = 1812 | | AP20 = 2220 | | | |
|------|-------------|-----|-----|------|------|-------------|-----|-----|------|------|-------------|-----|-----|------|------|-------------|-----|-----|-----|-------------|-----|-------------|-----|-----|------|
| | 16V | 25V | 50V | 100V | 200V | 16V | 25V | 50V | 100V | 200V | 16V | 25V | 50V | 100V | 200V | 500V | 16V | 25V | 50V | 100V | 50V | 100V | 25V | 50V | 100V |
| 102 | Cap 1000 | G | G | G | G | G | J | J | J | J | J | J | J | J | J | J | K | K | K | K | K | K | | | |
| 182 | (pF) 1800 | G | G | G | G | | J | J | J | J | J | J | J | J | J | J | K | K | K | K | K | K | | | |
| 222 | 2200 | G | G | G | G | | J | J | J | J | J | J | J | J | J | J | K | K | K | K | K | K | | | |
| 332 | 3300 | G | G | G | G | | J | J | J | J | J | J | J | J | J | J | K | K | K | K | K | K | | | |
| 472 | 4700 | G | G | G | G | | J | J | J | J | J | J | J | J | J | J | K | K | K | K | K | K | | | |
| 103 | 0.01 | G | G | G | G | | J | J | J | J | J | J | J | J | J | J | K | K | K | K | K | K | | | |
| 123 | 0.012 | G | G | G | | | J | J | J | M | | J | J | J | J | J | K | K | K | K | K | K | | | |
| 153 | 0.015 | G | G | G | | | J | J | J | M | | J | J | J | J | J | K | K | K | K | K | K | | | |
| 183 | 0.018 | G | G | G | | | J | J | J | M | | J | J | J | J | J | K | K | K | K | K | K | | | |
| 223 | 0.022 | G | G | G | | | J | J | J | M | | J | J | J | J | J | K | K | K | K | K | K | | | |
| 273 | 0.027 | G | G | G | | | J | J | J | M | | J | J | J | J | J | K | K | K | K | K | K | | | |
| 333 | 0.033 | G | G | G | | | J | J | J | M | | J | J | J | J | J | K | K | K | K | K | K | | | |
| 473 | 0.047 | G | G | G | | | J | J | J | M | | J | J | J | M | J | K | K | K | K | K | K | | | |
| 563 | 0.056 | G | G | G | | | J | J | J | M | | J | J | J | M | J | K | K | K | K | M | K | | | |
| 683 | 0.068 | G | G | G | | | J | J | J | M | | J | J | J | M | J | K | K | K | M | K | K | | | |
| 823 | 0.082 | G | G | G | | | J | J | J | M | | J | J | J | M | J | K | K | K | M | K | K | | | |
| 104 | 0.1 | G | G | G | | | J | J | M | M | | J | J | J | M | J | K | K | K | M | K | K | | | |
| 124 | 0.12 | | | | | | J | J | M | N | | J | J | M | M | | K | K | K | P | K | K | | | |
| 154 | 0.15 | | | | | | M | N | M | N | | J | J | M | M | | K | K | K | P | K | K | | | |
| 224 | 0.22 | | | | | | M | N | M | N | | J | M | M | Q | | M | M | M | P | M | M | | | |
| 334 | 0.33 | | | | | | N | N | M | N | | J | M | P | Q | | P | P | P | Q | X | X | | | |
| 474 | 0.47 | | | | | | N | N | M | N | | M | M | P | Q | | P | P | P | Q | X | X | | | |
| 684 | 0.68 | | | | | | N | N | N | | | M | Q | Q | Q | | P | P | Q | X | X | X | | | |
| 105 | Cap 1.0 | | | | | | N | N | N* | | | M | Q | Q | Q* | | P | Q | Q | Z* | X | X | | | |
| 155 | (µF) 1.5 | | | | | | | | | | | Q | Q | Q | | | P | Q | Z | Z | X | X | | | |
| 225 | 2.2 | | | | | | | | | | | Q | Q | Q | | | Z | Z | Z | Z* | Z | Z | | | |
| 335 | 3.3 | | | | | | | | | | | Q | | | | | X | Z | Z | Z | Z | | | | |
| 475 | 4.7 | | | | | | | | | | | Q | | | | | X | Z | Z | | Z* | | | | |
| 106 | 10 | | | | | | | | | | | | | | | | Z | Z* | | | | | | Z | Z* |
| 226 | 22 | | | | | | | | | | | | | | | | | | | | | | Z | | Z* |
| WVDC | 16V | 25V | 50V | 100V | 200V | 16V | 25V | 50V | 100V | 200V | 16V | 25V | 50V | 100V | 200V | 500V | 16V | 25V | 50V | 100V | 50V | 100V | 25V | 50V | 100V |
| Size | AP03 = 0603 | | | | | AP05 = 0805 | | | | | AP06 = 1206 | | | | | AP10 = 1210 | | | | AP12 = 1812 | | AP20 = 2220 | | | |

*Not currently available with lead plating finish, contact plant for further information.

| Letter | A | C | E | G | J | K | M | N | P | Q | X | Y | Z |
|----------------|-----------------|-----------------|-----------------|-----------------|-----------------|-----------------|-----------------|-----------------|-----------------|-----------------|-----------------|-----------------|-----------------|
| Max. Thickness | 0.33 (0.013) | 0.56 (0.022) | 0.71 (0.028) | 0.90 (0.035) | 0.94 (0.037) | 1.02 (0.040) | 1.27 (0.050) | 1.40 (0.055) | 1.52 (0.060) | 1.78 (0.070) | 2.29 (0.090) | 2.54 (0.100) | 2.79 (0.110) |
| | PAPER | | | | | EMBOSSSED | | | | | | | |

TS 16949, ISO 9001 Certified



The Important Information/Disclaimer is incorporated in the catalog where these specifications came from or available online at www.avx.com/disclaimer/ by reference and should be reviewed in full before placing any order.

APS COTS+ X8R/L Series

Capacitance Range



X8R

| SIZE | | AP03 = 0603 | | AP05 = 0805 | | AP06 = 1206 | |
|------|------------|-------------|-----|-------------|-----|-------------|-----|
| WVDC | | 25V | 50V | 25V | 50V | 25V | 50V |
| 331 | Cap 330 | G | G | J | J | | |
| 471 | (pF) 470 | G | G | J | J | | |
| 681 | 680 | G | G | J | J | | |
| 102 | 1000 | G | G | J | J | J | J |
| 152 | 1500 | G | G | J | J | J | J |
| 222 | 2200 | G | G | J | J | J | J |
| 332 | 3300 | G | G | J | J | J | J |
| 472 | 4700 | G | G | J | J | J | J |
| 682 | 6800 | G | G | J | J | J | J |
| 103 | Cap 0.01 | G | G | J | J | J | J |
| 153 | (μF) 0.015 | G | G | J | J | J | J |
| 223 | 0.022 | G | G | J | J | J | J |
| 333 | 0.033 | G | G | J | J | J | J |
| 473 | 0.047 | G | G | J | J | J | J |
| 683 | 0.068 | G | | N | N | M | M |
| 104 | 0.1 | | | N | N | M | M |
| 154 | 0.15 | | | N | N | M | M |
| 224 | 0.22 | | | N | | M | M |
| 334 | 0.33 | | | | | M | M |
| 474 | 0.47 | | | | | M | |
| 684 | 0.68 | | | | | | |
| 105 | 1 | | | | | | |
| WVDC | | 25V | 50V | 25V | 50V | 25V | 50V |
| SIZE | | 0603 | | 0805 | | 1206 | |

X8L

| SIZE | | AP03 = 0603 | | | AP05 = 0805 | | | AP06 = 1206 | | | |
|------|------------|-------------|-----|------|-------------|-----|------|-------------|-----|-----|------|
| WVDC | | 25V | 50V | 100V | 25V | 50V | 100V | 16V | 25V | 50V | 100V |
| 331 | Cap 330 | | G | G | | J | J | | | | |
| 471 | (pF) 470 | | G | G | | J | J | | | | |
| 681 | 680 | | G | G | | J | J | | | | |
| 102 | 1000 | | G | G | | J | J | | | | |
| 152 | 1500 | | G | G | | J | J | | | J | J |
| 222 | 2200 | | G | G | | J | J | | | J | J |
| 332 | 3300 | | G | G | | J | J | | | J | J |
| 472 | 4700 | | G | G | | J | J | | | J | J |
| 682 | 6800 | | G | G | | J | J | | | J | J |
| 103 | Cap 0.01 | | G | G | | J | J | | | J | J |
| 153 | (μF) 0.015 | G | G | | J | J | J | | | J | J |
| 223 | 0.022 | G | G | | J | J | J | | | J | J |
| 333 | 0.033 | G | G | | J | J | N | | | J | J |
| 473 | 0.047 | G | G | | J | J | N | | | J | J |
| 683 | 0.068 | G | G | | J | J | | | | J | J |
| 104 | 0.1 | G | G | | J | J | | | | J | M |
| 154 | 0.15 | | | | J | N | | J | J | J | Q |
| 224 | 0.22 | | | | N | N | | J | J | J | Q |
| 334 | 0.33 | | | | N | | | J | M | P | Q |
| 474 | 0.47 | | | | N | | | M | M | P | |
| 684 | 0.68 | | | | | | | M | | | |
| 105 | 1 | | | | | | | M | | | |
| WVDC | | 25V | 50V | 100V | 25V | 50V | 100V | 16V | 25V | 50V | 100V |
| SIZE | | 0603 | | | 0805 | | | 1206 | | | |



| Letter | A | C | E | G | J | K | M | N | P | Q | X | Y | Z |
|----------------|-----------------|-----------------|-----------------|-----------------|-----------------|-----------------|-----------------|-----------------|-----------------|-----------------|-----------------|-----------------|-----------------|
| Max. Thickness | 0.33 (0.013) | 0.56 (0.022) | 0.71 (0.028) | 0.90 (0.035) | 0.94 (0.037) | 1.02 (0.040) | 1.27 (0.050) | 1.40 (0.055) | 1.52 (0.060) | 1.78 (0.070) | 2.29 (0.090) | 2.54 (0.100) | 2.79 (0.110) |
| | PAPER | | | | | EMBOSSED | | | | | | | |

TS 16949, ISO 9001 Certified

GENERAL DESCRIPTION

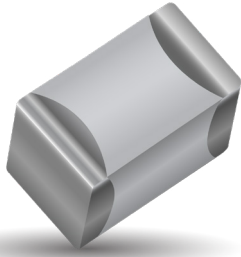

With increased requirements from the automotive industry for additional component robustness, AVX recognized the need to produce a MLCC with enhanced mechanical strength. It was noted that many components may be subject to severe flexing and vibration when used in various under the hood automotive and other harsh environment applications.

To satisfy the requirement for enhanced mechanical strength, AVX had to find a way of ensuring electrical integrity is maintained whilst external forces are being applied to the component. It was found that the structure of the termination needed to be flexible and after much research and development, AVX launched FLEXITERM®. FLEXITERM® is designed to enhance the mechanical flexure and temperature cycling performance of a standard ceramic capacitor with an X7R dielectric. The industry standard for flexure is 2mm minimum. Using FLEXITERM®, AVX provides up to 5mm of flexure without internal cracks. Beyond 5mm, the capacitor will generally fail "open".

As well as for automotive applications FLEXITERM® will provide Design Engineers with a satisfactory solution when designing PCB's which may be subject to high levels of board flexure.

PRODUCT ADVANTAGES

- High mechanical performance able to withstand, 5mm bend test guaranteed
- Increased temperature cycling performance, 3000 cycles and beyond
- Flexible termination system
- Reduction in circuit board flex failures
- Base metal electrode system
- Automotive or commercial grade products available
- AECQ200 Qualified
- Approved to VW 80808 Specification

APPLICATIONS

High Flexure Stress Circuit Boards

- e.g. Depanelization: Components near edges of board.

Variable Temperature Applications

- Soft termination offers improved reliability performance in applications where there is temperature variation.
- e.g. All kind of engine sensors: Direct connection to battery rail.

Automotive Applications

- Improved reliability.
- Excellent mechanical performance and thermo mechanical performance.

HOW TO ORDER

0805

Style
0603
0805
1206
1210
1812
2220

5

Voltage
6 = 6.3V
Z = 10V
Y = 16V
3 = 25V
5 = 50V
1 = 100V
2 = 200V

C

Dielectric
C = X7R
F = X8R

104

Capacitance Code (In pF)
2 Sig Digits +
Number of Zeros
e.g., 104 = 100nF

K

Capacitance Tolerance
J = $\pm 5\%$ *
K = $\pm 10\%$
M = $\pm 20\%$

* $\leq 1\mu\text{F}$ only

A

Failure Rate
A=Commercial
4 = Automotive

Z

Terminations
Z = FLEXITERM®
For FLEXITERM®
with Tin/Lead
termination see
AVXLD Series

2

Packaging
2 = 7" Reel
4 = 13" Reel

A

Special Code
A = Std.Product



NOTE: Contact factory for availability of Tolerance Options for Specific Part Numbers.

PERFORMANCE TESTING

AEC-Q200 Qualification:

- Created by the Automotive Electronics Council
- Specification defining stress test qualification for passive components



Testing:

Key tests used to compare soft termination to AEC-Q200 qualification:

- Bend Test
- Temperature Cycle Test

BOARD BEND TEST RESULTS

AEC-Q200 Vrs AVX FLEXITERM® Bend Test

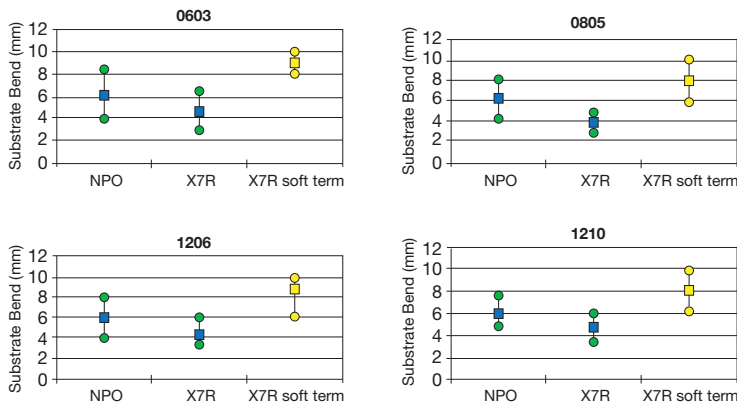

TABLE SUMMARY

Typical bend test results are shown below:

| Style | Conventional Termination | FLEXITERM® |
|-------|--------------------------|------------|
| 0603 | >2mm | >5mm |
| 0805 | >2mm | >5mm |
| 1206 | >2mm | >5mm |

TEMPERATURE CYCLE TEST PROCEDURE

Test Procedure as per AEC-Q200:

The test is conducted to determine the resistance of the component when it is exposed to extremes of alternating high and low temperatures.

- Sample lot size quantity 77 pieces
- TC chamber cycle from -55°C to +125°C for 1000 cycles
- Interim electrical measurements at 250, 500, 1000 cycles
- Measure parameter capacitance dissipation factor, insulation resistance

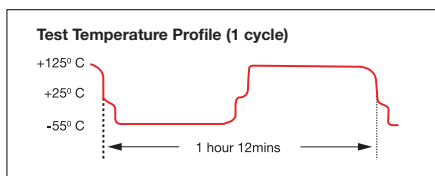

BOARD BEND TEST PROCEDURE

According to AEC-Q200

Test Procedure as per AEC-Q200:
 Sample size: 20 components
 Span: 90mm Minimum deflection spec: 2 mm

- Components soldered onto FR4 PCB (Figure 1)
- Board connected electrically to the test equipment (Figure 2)

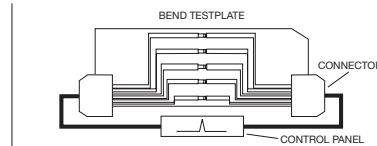

Fig 1 - PCB layout with electrical connections

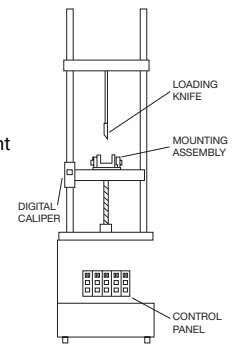
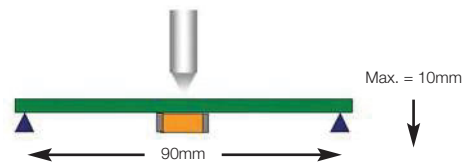

Fig 2 - Board Bend test equipment

AVX ENHANCED SOFT TERMINATION BEND TEST PROCEDURE

Bend Test

The capacitor is soldered to the printed circuit board as shown and is bent up to 10mm at 1mm per second:



- The board is placed on 2 supports 90mm apart (capacitor side down)
- The row of capacitors is aligned with the load stressing knife



- The load is applied and the deflection where the part starts to crack is recorded (Note: Equipment detects the start of the crack using a highly sensitive current detection circuit)
- The maximum deflection capability is 10mm

BEYOND 1000 CYCLES: TEMPERATURE CYCLE TEST RESULTS

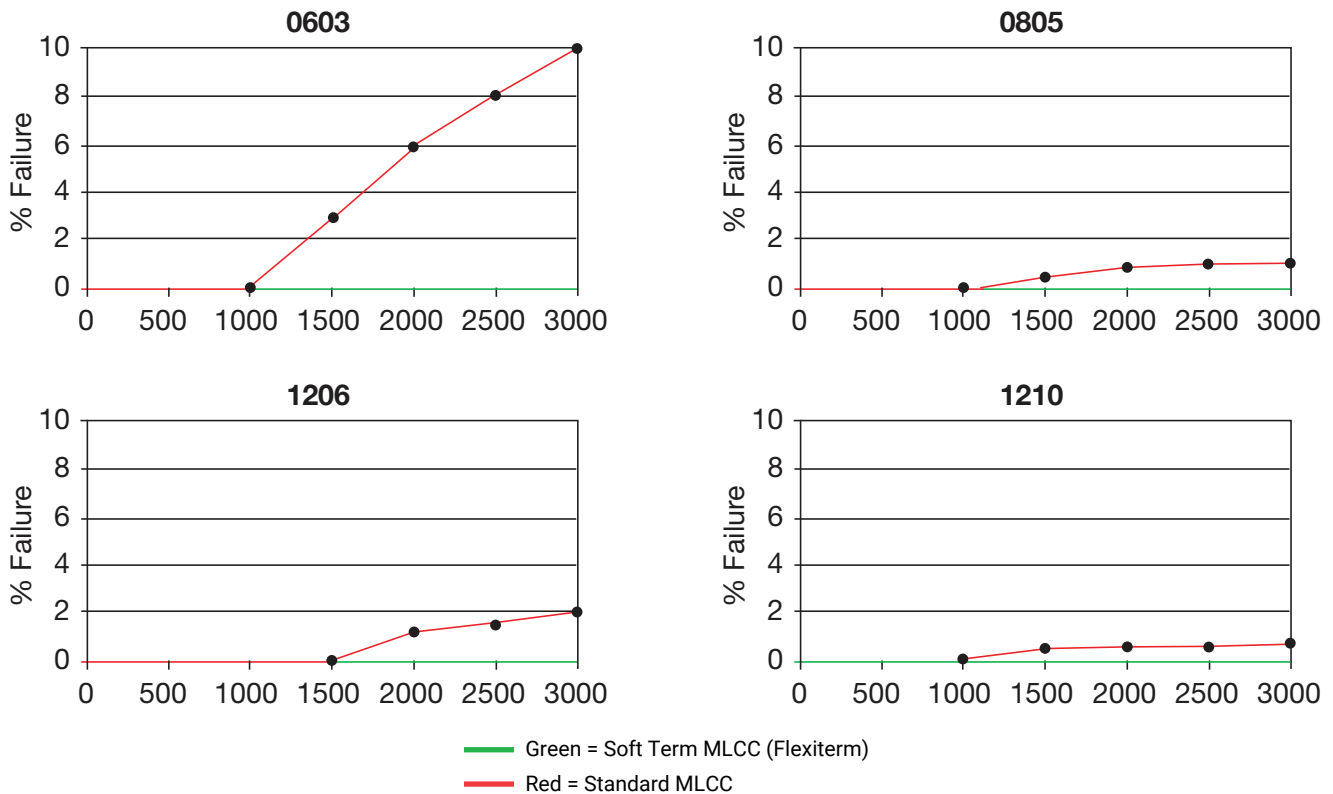

Soft Term - No Defects up to 3000 cycles

AEC-Q200 specification states 1000 cycles compared to AVX 3000 temperature cycles.

FLEXITERM® TEST SUMMARY

- Qualified to AEC-Q200 test/specification with the exception of using AVX 3000 temperature cycles (up to +150°C bend test guaranteed greater than 5mm).
- FLEXITERM® provides improved performance compared to standard termination systems.
- Board bend test improvement by a factor of 2 to 4 times.
- Temperature Cycling:
 - 0% Failure up to 3000 cycles
 - No ESR change up to 3000 cycle

WITHOUT SOFT TERMINATION

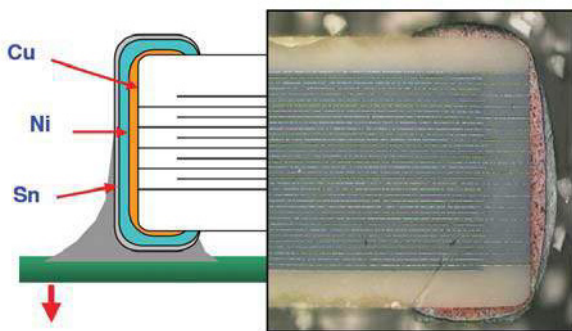

Major fear is of latent board flex failures.

WITH SOFT TERMINATION

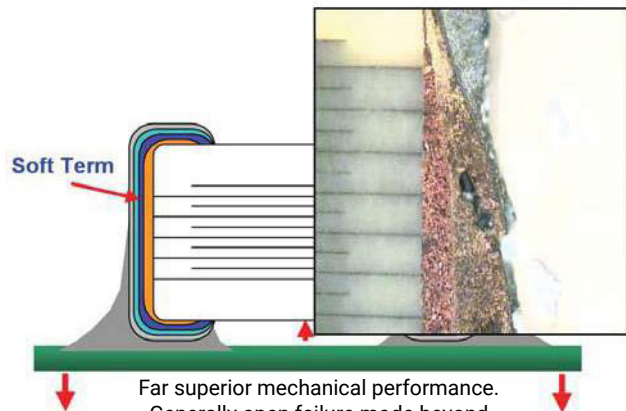

Far superior mechanical performance. Generally open failure mode beyond 5mm flexure

MLCC with FLEXITERM®

Capacitance Range X8R Dielectric



| SIZE | | 0603 | | 0805 | | 1206 | |
|-----------|------------|-------------|-----|-------------|-----|-------------|-----|
| Soldering | | Reflow/Wave | | Reflow/Wave | | Reflow/Wave | |
| WVDC | | 25V | 50V | 25V | 50V | 25V | 50V |
| 271 | Cap 270 | G | G | | | | |
| 331 | (pF) 330 | G | G | J | J | | |
| 471 | 470 | G | G | J | J | | |
| 681 | 680 | G | G | J | J | | |
| 102 | 1000 | G | G | J | J | J | J |
| 152 | 1500 | G | G | J | J | J | J |
| 182 | 1800 | G | G | J | J | J | J |
| 222 | 2200 | G | G | J | J | J | J |
| 272 | 2700 | G | G | J | J | J | J |
| 332 | 3300 | G | G | J | J | J | J |
| 392 | 3900 | G | G | J | J | J | J |
| 472 | 4700 | G | G | J | J | J | J |
| 562 | 5600 | G | G | J | J | J | J |
| 682 | 6800 | G | G | J | J | J | J |
| 822 | 8200 | G | G | J | J | J | J |
| 103 | Cap 0.01 | G | G | J | J | J | J |
| 123 | (µF) 0.012 | G | G | J | J | J | J |
| 153 | 0.015 | G | G | J | J | J | J |
| 183 | 0.018 | G | G | J | J | J | J |
| 223 | 0.022 | G | G | J | J | J | J |
| 273 | 0.027 | G | G | J | J | J | J |
| 333 | 0.033 | G | G | J | J | J | J |
| 393 | 0.039 | G | G | J | J | J | J |
| 473 | 0.047 | G | G | J | J | J | J |
| 563 | 0.056 | G | | N | N | M | M |
| 683 | 0.068 | G | | N | N | M | M |
| 823 | 0.082 | | | N | N | M | M |
| 104 | 0.1 | | | N | N | M | M |
| 124 | 0.12 | | | N | N | M | M |
| 154 | 0.15 | | | N | N | M | M |
| 184 | 0.18 | | | N | | M | M |
| 224 | 0.22 | | | N | | M | M |
| 274 | 0.27 | | | | | M | M |
| 334 | 0.33 | | | | | M | M |
| 394 | 0.39 | | | | | M | |
| 474 | 0.47 | | | | | M | |
| 684 | 0.68 | | | | | | |
| 824 | 0.82 | | | | | | |
| 105 | 1 | | | | | | |
| WVDC | | 25V | 50V | 25V | 50V | 25V | 50V |
| SIZE | | 0603 | | 0805 | | 1206 | |

| Letter | A | C | E | G | J | K | M | N | P | Q | X | Y | Z |
|----------------|-----------------|-----------------|-----------------|-----------------|-----------------|-----------------|-----------------|-----------------|-----------------|-----------------|-----------------|-----------------|-----------------|
| Max. Thickness | 0.33 (0.013) | 0.56 (0.022) | 0.71 (0.028) | 0.90 (0.035) | 0.94 (0.037) | 1.02 (0.040) | 1.27 (0.050) | 1.40 (0.055) | 1.52 (0.060) | 1.78 (0.070) | 2.29 (0.090) | 2.54 (0.100) | 2.79 (0.110) |
| | PAPER | | | | | EMBOSSSED | | | | | | | |

TS 16949, ISO 9001 Certified

MLCC with FLEXITERM®

Capacitance Range X7R Dielectric



| Size | 0402 | | | 0603 | | | | | | 0805 | | | | | | 1206 | | | | | | 1210 | | | | 1812 | | | | 2220 | | | | |
|------|-------------|-------|-----|-------------|-----|-----|-----|------|------|-------------|-----|-----|-----|------|------|-------------|-----|-----|-----|------|------|-------------|------|-----|-----|-------------|------|-----|------|-------------|-----|------|---|---|
| | Reflow/Wave | | | Reflow/Wave | | | | | | Reflow/Wave | | | | | | Reflow/Wave | | | | | | Reflow Only | | | | Reflow Only | | | | Reflow Only | | | | |
| WVDC | 16V | 25V | 50V | 10V | 16V | 25V | 50V | 100V | 200V | 250V | 16V | 25V | 50V | 100V | 200V | 250V | 16V | 25V | 50V | 100V | 200V | 250V | 500V | 16V | 25V | 50V | 100V | 50V | 100V | 25V | 50V | 100V | | |
| 221 | Cap | 220 | C | C | C | | | | | | | | | | | | | | | | | | | | | | | | | | | | | |
| 271 | (pF) | 270 | C | C | C | | | | | | | | | | | | | | | | | | | | | | | | | | | | | |
| 331 | | 330 | C | C | C | | | | | | | | | | | | | | | | | | | | | | | | | | | | | |
| 391 | | 390 | C | C | C | | | | | | | | | | | | | | | | | | | | | | | | | | | | | |
| 471 | | 470 | C | C | C | | | | | | | | | | | | | | | | | | | | | | | | | | | | | |
| 561 | | 560 | C | C | C | | | | | | | | | | | | | | | | | | | | | | | | | | | | | |
| 681 | | 680 | C | C | C | | | | | | | | | | | | | | | | | | | | | | | | | | | | | |
| 821 | | 820 | C | C | C | | | | | | | | | | | | | | | | | | | | | | | | | | | | | |
| 102 | | 1000 | C | C | C | G | G | G | G | G | G | J | J | J | J | J | J | J | J | J | J | J | J | J | K | K | K | K | N | N | | | | |
| 182 | | 1800 | C | C | C | G | G | G | G | G | G | J | J | J | J | J | J | J | J | J | J | J | J | J | K | K | K | K | N | N | | | | |
| 222 | | 2200 | C | C | C | G | G | G | G | G | G | J | J | J | J | J | J | J | J | J | J | J | J | J | K | K | K | K | N | N | | | | |
| 332 | | 3300 | C | C | C | G | G | G | G | G | G | J | J | J | J | J | J | J | J | J | J | J | J | J | K | K | K | K | N | N | | | | |
| 472 | | 4700 | C | C | C | G | G | G | G | G | G | J | J | J | J | J | J | J | J | J | J | J | J | J | K | K | K | K | N | N | | | | |
| 103 | Cap | 0.01 | C | | | G | G | G | G | G | G | J | J | J | J | J | J | J | J | J | J | J | J | J | K | K | K | K | N | N | | | | |
| 123 | (µF) | 0.012 | C | | | G | G | G | | | | J | J | J | N | N | N | J | J | J | J | J | J | J | K | K | K | K | N | N | | | | |
| 153 | | 0.015 | C | | | G | G | G | | | | J | J | J | N | N | N | J | J | J | J | J | J | J | K | K | K | K | N | N | | | | |
| 183 | | 0.018 | C | | | G | G | G | | | | J | J | J | N | N | N | J | J | J | J | J | J | J | K | K | K | K | N | N | | | | |
| 223 | | 0.022 | C | | | G | G | G | | | | J | J | J | N | N | N | J | J | J | J | J | J | J | K | K | K | K | N | N | | | | |
| 273 | | 0.027 | C | | | G | G | G | | | | J | J | J | N | N | N | J | J | J | J | J | J | J | K | K | K | K | N | N | | | | |
| 333 | | 0.033 | C | | | G | G | G | | | | J | J | J | N | N | N | J | J | J | J | J | J | J | K | K | K | K | N | N | | | | |
| 473 | | 0.047 | | | | G | G | G | | | | J | J | J | N | N | N | J | J | J | M | J | J | J | K | K | K | K | N | N | | | | |
| 563 | | 0.056 | | | | G | G | G | | | | J | J | J | N | | | J | J | J | M | J | J | J | K | K | K | M | N | N | | | | |
| 683 | | 0.068 | | | | G | G | G | | | | J | J | J | N | | | J | J | J | M | J | J | J | K | K | K | M | N | N | | | | |
| 823 | | 0.082 | | | | G | G | G | | | | J | J | J | N | | | J | J | J | M | J | J | J | K | K | K | M | N | N | | | | |
| 104 | | 0.1 | C | | | G | G | G | | | | J | J | J | N | | | J | J | J | M | J | J | J | K | K | K | M | N | N | | | | |
| 124 | | 0.12 | | | | | | | | | | J | J | N | N | | | J | J | M | M | | | J | K | K | K | P | N | N | | | | |
| 154 | | 0.15 | | | | | | | | | | M | N | N | N | | | J | J | M | M | | | J | K | K | K | P | N | N | | | | |
| 224 | | 0.22 | | | G | J | J | J | | | | M | N | N | N | | | J | M | M | Q | | | M | M | M | P | N | N | | | | | |
| 334 | | 0.33 | | | | | | | | | | N | N | N | N | | | J | M | P | Q | | | P | P | P | Q | X | X | | | | | |
| 474 | | 0.47 | | | J | J | J | | | | | N | N | N | N | | | M | M | P | Q | | | P | P | P | Q | X | X | | | | | |
| 684 | | 0.68 | | | | | | | | | | N | N | N | N | | | M | Q | Q | Q | | | P | P | Q | X | X | X | | | | | |
| 105 | | 1 | | | | | | | | | | N | N | N | N | | | M | Q | Q | Q | | | P | Q | Q | Z | X | X | | | | | |
| 155 | | 1.5 | | | | | | | | | | N | N | | | | | Q | Q | Q | | | | P | Q | Z | Z | X | X | | | | | |
| 225 | | 2.2 | | | | | | | | | | N | N | | | | | Q | Q | Q | | | | X | Z | Z | Z | Z | Z | | | | | |
| 335 | | 3.3 | | | | | | | | | | | | | | | | Q | Q | | | | | X | Z | Z | Z | Z | | | | | | |
| 475 | | 4.7 | | | | | | | | | | | | | | | | Q | Q | | | | | X | Z | Z | Z | Z | | | | | Z | |
| 106 | | 10 | | | | | | | | | | | | | | | | | | | | | | Z | Z | Z | | | | | | Z | Z | |
| 226 | | 22 | | | | | | | | | | | | | | | | | | | | | | | | | | | | | | | Z | Z |
| WVDC | 16V | 25V | 50V | 10V | 16V | 25V | 50V | 100V | 200V | 250V | 16V | 25V | 50V | 100V | 200V | 250V | 16V | 25V | 50V | 100V | 200V | 250V | 500V | 16V | 25V | 50V | 100V | 50V | 100V | 25V | 50V | 100V | | |
| Size | 0402 | | | 0603 | | | | | | 0805 | | | | | | 1206 | | | | | | 1210 | | | | 1812 | | | | 2220 | | | | |

| Letter | A | C | E | G | J | K | M | N | P | Q | X | Y | Z |
|----------------|-----------------|-----------------|-----------------|-----------------|-----------------|-----------------|-----------------|-----------------|-----------------|-----------------|-----------------|-----------------|-----------------|
| Max. Thickness | 0.33 (0.013) | 0.56 (0.022) | 0.71 (0.028) | 0.90 (0.035) | 0.94 (0.037) | 1.02 (0.040) | 1.27 (0.050) | 1.40 (0.055) | 1.52 (0.060) | 1.78 (0.070) | 2.29 (0.090) | 2.54 (0.100) | 2.79 (0.110) |
| | PAPER | | | | | EMBOSSED | | | | | | | |



The Important Information/Disclaimer is incorporated in the catalog where these specifications came from or available online at www.avx.com/disclaimer/ by reference and should be reviewed in full before placing any order.

FLEXISAFE MLC Chips

General Specifications and Capacitance Range For Ultra Safety Critical Applications



AVX have developed a range of components specifically for safety critical applications.

Utilizing the award-winning FLEXITERM™ layer in conjunction with the cascade design previously used for high voltage MLCCs, a range of ceramic capacitors is now available for customers who require components designed with an industry leading set of safety features.

The FLEXITERM™ layer protects the component from any damage to the ceramic resulting from mechanical stress during PCB assembly or use with end customers. Board flexure type mechanical damage accounts for the majority of MLCC failures. The addition of the cascade structure protects the component from low insulation resistance failure resulting from other common causes for failure; thermal stress damage, repetitive strike ESD damage and placement damage. With the inclusion of the cascade design structure to complement the FLEXITERM™ layer, the FLEXISAFE range of capacitors has unbeatable safety features. Flexisafe capacitors are qualified in accordance with AEC-Q200 standard. AEC-Q200 detailed qualification data is available on request

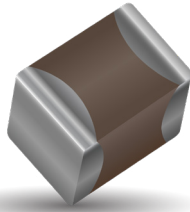

HOW TO ORDER

| FS05 | 5 | C | 104 | K | Q | Z | 2 | A |
|---|---|------------------------------|---|---|--|--|---|--|
| Size FS03 = 0603 FS05 = 0805 FS06 = 1206 FS10 = 1210 | Voltage 16V = Y 25V = 3 50V = 5 100V = 1 | Dielectric X7R = C | Capacitance Code (In pF) 2 Sig. Digits + Number of Zeros e.g. 10µF = 106 | Capacitance Tolerance J = ±5% K = ±10% M = ±20% | Failure Rate A = Commercial 4 = Automotive Q = APS | Terminations Z = FLEXITERM™ *X = FLEXITERM™ with 5% min lead *Not RoHS Compliant | Packaging 2 = 7" Reel 4 = 13" Reel | Special Code A = Std.Product |

CAPACITANCE RANGE FLEXISAFE X7R

| SIZE | wVDC | FS03 = 0603 | | | | FS05 = 0805 | | | | FS06 = 1206 | | | FS10 = 1210 | | |
|------|-------|-------------|----|----|-----|-------------|----|----|-----|-------------|----|----|-------------|----|----|
| | | 16 | 25 | 50 | 100 | 16 | 25 | 50 | 100 | 16 | 25 | 50 | 16 | 25 | 50 |
| 102 | 1000 | G | G | G | G | J | J | J | J | J | J | J | | | |
| 182 | 1800 | G | G | G | G | J | J | J | J | J | J | J | | | |
| 222 | 2200 | G | G | G | G | J | J | J | J | J | J | J | | | |
| 332 | 3300 | G | G | G | G | J | J | J | J | J | J | J | | | |
| 472 | 4700 | G | G | G | G | J | J | J | J | J | J | J | | | |
| 682 | 6800 | G | G | G | G | J | J | J | J | J | J | J | | | |
| 103 | 0.01 | G | G | G | G | J | J | J | J | J | J | J | | | |
| 123 | 0.012 | G | G | G | | J | J | J | J | J | J | J | | | |
| 153 | 0.015 | G | G | G | | J | J | J | J | J | J | J | | | |
| 183 | 0.018 | G | G | G | | J | J | J | J | J | J | J | | | |
| 223 | 0.022 | G | G | G | | N | N | N | N | J | J | J | | | |
| 273 | 0.027 | | | | | N | N | N | N | J | J | J | | | |
| 333 | 0.033 | | | | | N | N | N | N | J | J | J | | | |
| 473 | 0.047 | | | | | N | N | N | N | M | M | M | | | |
| 563 | 0.056 | | | | | N | N | N | N | M | M | M | | | |
| 683 | 0.068 | | | | | N | N | N | N | M | M | M | | | |
| 823 | 0.082 | | | | | N | N | N | N | M | M | M | | | |
| 104 | 0.1 | | | | | N | N | N | N | M | M | M | | | |
| 124 | 0.12 | | | | | | | | | M | M | M | | | |
| 154 | 0.15 | | | | | | | | | M | M | M | Q | Q | Q |
| 224 | 0.22 | | | | | | | | | | | | Q | Q | Q |
| 334 | 0.33 | | | | | | | | | | | | Q | Q | Q |
| 474 | 0.47 | | | | | | | | | | | | Q | Q | Q |

| | | | | | |
|----------------|--------------|--------------|--------------|--------------|--------------|
| Letter | G | J | M | N | Q |
| Max. Thickness | 0.90 (0.035) | 0.94 (0.037) | 1.27 (0.050) | 1.40 (0.055) | 1.78 (0.070) |
| | PAPER | | EMBOSSED | | |



Capacitor Array

Capacitor Array (IPC)

BENEFITS OF USING CAPACITOR ARRAYS

AVX capacitor arrays offer designers the opportunity to lower placement costs, increase assembly line output through lower component count per board and to reduce real estate requirements.

Reduced Costs

Placement costs are greatly reduced by effectively placing one device instead of four or two. This results in increased throughput and translates into savings on machine time. Inventory levels are lowered and further savings are made on solder materials, etc.

Space Saving

Space savings can be quite dramatic when compared to the use of discrete chip capacitors. As an example, the 0508 4-element array offers a space reduction of >40% vs. 4 x 0402 discrete capacitors and of >70% vs. 4 x 0603 discrete capacitors. (This calculation is dependent on the spacing of the discrete components.)

Increased Throughput

Assuming that there are 220 passive components placed in a mobile phone:

A reduction in the passive count to 200 (by replacing discrete components with arrays) results in an increase in throughput of approximately 9%.

A reduction of 40 placements increases throughput by 18%.

For high volume users of cap arrays using the very latest placement equipment capable of placing 10 components per second, the increase in throughput can be very significant and can have the overall effect of reducing the number of placement machines required to mount components:

If 120 million 2-element arrays or 40 million 4-element arrays were placed in a year, the requirement for placement equipment would be reduced by one machine.

During a 20Hr operational day a machine places 720K components. Over a working year of 167 days the machine can place approximately 120 million. If 2-element arrays are mounted instead of discrete components, then the number of placements is reduced by a factor of two and in the scenario where 120 million 2-element arrays are placed there is a saving of one pick and place machine.

Smaller volume users can also benefit from replacing discrete components with arrays. The total number of placements is reduced thus creating spare capacity on placement machines. This in turn generates the opportunity to increase overall production output without further investment in new equipment.

W2A (0508) Capacitor Arrays

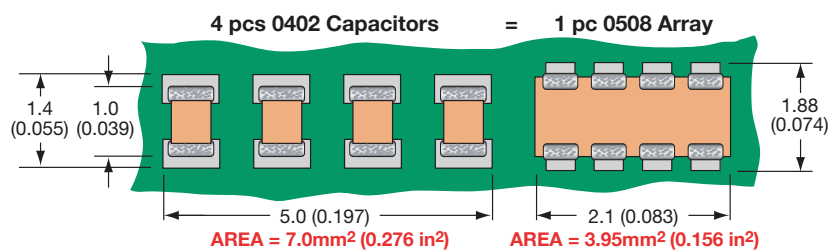

The 0508 4-element capacitor array gives a PCB space saving of over 40% vs four 0402 discrettes and over 70% vs four 0603 discrete capacitors.

W3A (0612) Capacitor Arrays

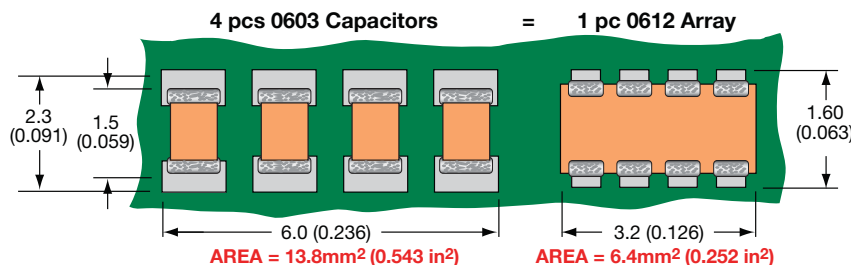

The 0612 4-element capacitor array gives a PCB space saving of over 50% vs four 0603 discrettes and over 70% vs four 0805 discrete capacitors.

Capacitor Array

Capacitor Array (IPC)

GENERAL DESCRIPTION

AVX is the market leader in the development and manufacture of capacitor arrays. The array family of products also includes the 0612 4-element device as well as 0508 2-element and 4-element series, all of which have received widespread acceptance in the marketplace.

AVX capacitor arrays are available in X5R, X7R and NP0 (C0G) ceramic dielectrics to cover a broad range of capacitance values. Voltage ratings from 6.3 Volts up to 100 Volts are offered. AVX also now offers a range of automotive capacitor arrays qualified to AEC-Q200 (see separate table).

Key markets for capacitor arrays are Mobile and Cordless Phones, Digital Set Top Boxes, Computer Motherboards and Peripherals as well as Automotive applications, RF Modems, Networking Products, etc.

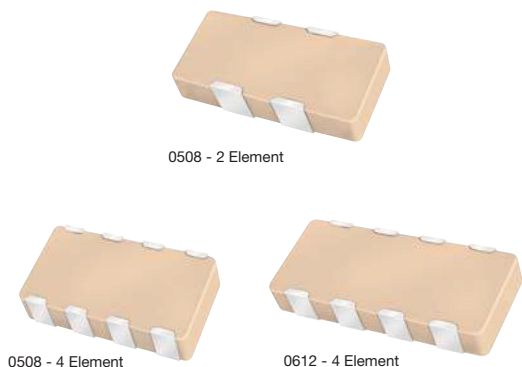

AVX Capacitor Array - W2A41A***K
S21 Magnitude

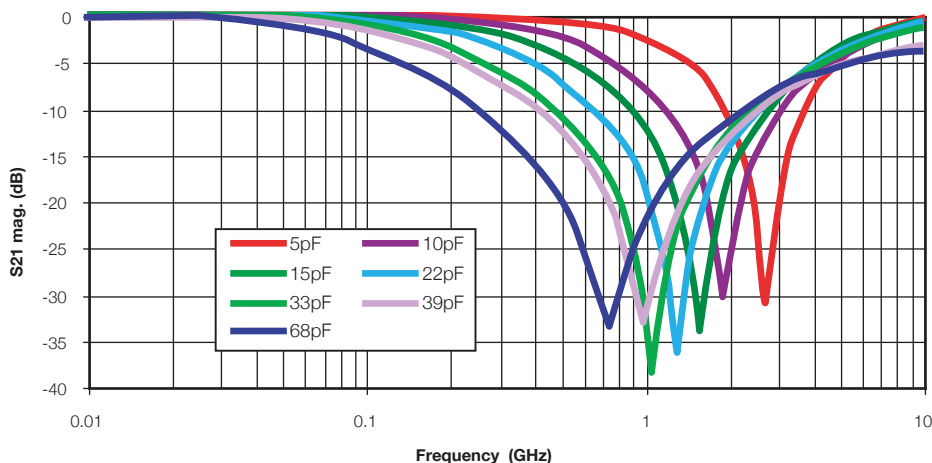

HOW TO ORDER

| | | | | | | | | | | |
|--------------------------------------|--|--------------|---|--|--|--|---|---|---|---|
| W | 2 | A | 4 | 3 | C | 103 | M | A | T | 2A |
| Style W = RoHS L = SnPb | Case Size 2 = 0508 3 = 0612 | Array | Number of Caps 2 = 2 Element 4 = 4 Element | Voltage 6 = 6V Z = 10V Y = 16V 3 = 25V 5 = 50V 1 = 100V | Dielectric A = NP0 C = X7R D = X5R | Capacitance Code 2 Sig. Digits + Number of Zeros | Capacitance Tolerance J = ±5% K = ±10% M = ±20% | Failure Rate A = Commercial 4 = Automotive | Termination Code *T = Plated Ni and Sn *Z = FLEXITERM® *B = 5% min lead *X = FLEXITERM® with 5% min lead | Packaging & Quantity Code 2A = 7" Reel (4000) 4A = 13" Reel (10000) 2F = 7" Reel (1000) |
| | | | | | | | | | *RoHS Compliant | *Not RoHS Compliant |



NOTE: Contact factory for availability of Termination and Tolerance Options for Specific Part Numbers.

Capacitor Array

Capacitance Range – NP0/COG

| SIZE | | | W2 = 0508 | | | W3 = 0612 | | |
|----------------|-------|-----------------|----------------|----|----|-----------------|----|----|
| # Elements | | | 4 | | | 4 | | |
| Soldering | | | Reflow/Wave | | | Reflow/Wave | | |
| Packaging | | | Paper/Embossed | | | Paper/Embossed | | |
| Length | mm | 1.30 ± 0.15 | | | | 1.60 ± 0.150 | | |
| | (in.) | (0.051 ± 0.006) | | | | (0.063 ± 0.006) | | |
| Width | mm | 2.10 ± 0.15 | | | | 3.20 ± 0.20 | | |
| | (in.) | (0.083 ± 0.006) | | | | (0.126 ± 0.008) | | |
| Max. Thickness | mm | 0.94 | | | | 1.35 | | |
| | (in.) | (0.037) | | | | (0.053) | | |
| | WVDC | | 16 | 25 | 50 | 16 | 25 | 50 |
| 1R0 | Cap | 1.0 | | | | | | |
| 1R2 | (pF) | 1.2 | | | | | | |
| 1R5 | | 1.5 | | | | | | |
| 1R8 | | 1.8 | | | | | | |
| 2R2 | | 2.2 | | | | | | |
| 2R7 | | 2.7 | | | | | | |
| 3R3 | | 3.3 | | | | | | |
| 3R9 | | 3.9 | | | | | | |
| 4R7 | | 4.7 | | | | | | |
| 5R6 | | 5.6 | | | | | | |
| 6R8 | | 6.8 | | | | | | |
| 8R2 | | 8.2 | | | | | | |
| 100 | | 10 | | | | | | |
| 120 | | 12 | | | | | | |
| 150 | | 15 | | | | | | |
| 180 | | 18 | | | | | | |
| 220 | | 22 | | | | | | |
| 270 | | 27 | | | | | | |
| 330 | | 33 | | | | | | |
| 390 | | 39 | | | | | | |
| 470 | | 47 | | | | | | |
| 560 | | 56 | | | | | | |
| 680 | | 68 | | | | | | |
| 820 | | 82 | | | | | | |
| 101 | | 100 | | | | | | |
| 121 | | 120 | | | | | | |
| 151 | | 150 | | | | | | |
| 181 | | 180 | | | | | | |
| 221 | | 220 | | | | | | |
| 271 | | 270 | | | | | | |
| 331 | | 330 | | | | | | |
| 391 | | 390 | | | | | | |
| 471 | | 470 | | | | | | |
| 561 | | 560 | | | | | | |
| 681 | | 680 | | | | | | |
| 821 | | 820 | | | | | | |
| 102 | | 1000 | | | | | | |
| 122 | | 1200 | | | | | | |
| 152 | | 1500 | | | | | | |
| 182 | | 1800 | | | | | | |
| 222 | | 2200 | | | | | | |
| 272 | | 2700 | | | | | | |
| 332 | | 3300 | | | | | | |
| 392 | | 3900 | | | | | | |
| 472 | | 4700 | | | | | | |
| 562 | | 5600 | | | | | | |
| 682 | | 6800 | | | | | | |
| 822 | | 8200 | | | | | | |

 = Supported Values

Capacitor Array

Capacitance Range – X7R



| SIZE | | W2 = 0508 | | | | | | W2 = 0508 | | | | | | W3 = 0612 | | | | | |
|----------------|-------|-----------------|----|----|----|----|-----|-----------------|----|----|----|----|-----|-----------------|----|----|----|----|-----|
| # Elements | | 2 | | | | | | 4 | | | | | | 4 | | | | | |
| Soldering | | Reflow/Wave | | | | | | Reflow/Wave | | | | | | Reflow/Wave | | | | | |
| Packaging | | All Paper | | | | | | Paper/Embossed | | | | | | Paper/Embossed | | | | | |
| Length | mm | 1.30 ± 0.15 | | | | | | 1.30 ± 0.15 | | | | | | 1.60 ± 0.150 | | | | | |
| | (in.) | (0.051 ± 0.006) | | | | | | (0.051 ± 0.006) | | | | | | (0.063 ± 0.006) | | | | | |
| Width | mm | 2.10 ± 0.15 | | | | | | 2.10 ± 0.15 | | | | | | 3.20 ± 0.20 | | | | | |
| | (in.) | (0.083 ± 0.006) | | | | | | (0.083 ± 0.006) | | | | | | (0.126 ± 0.008) | | | | | |
| Max. Thickness | mm | 0.94 | | | | | | 0.94 | | | | | | 1.35 | | | | | |
| | (in.) | (0.037) | | | | | | (0.037) | | | | | | (0.053) | | | | | |
| WVDC | | 6 | 10 | 16 | 25 | 50 | 100 | 6 | 10 | 16 | 25 | 50 | 100 | 6 | 10 | 16 | 25 | 50 | 100 |
| 101 | Cap | 100 | | | | | | | | | | | | | | | | | |
| 121 | (PF) | 120 | | | | | | | | | | | | | | | | | |
| 151 | | 150 | | | | | | | | | | | | | | | | | |
| 181 | | 180 | | | | | | | | | | | | | | | | | |
| 221 | | 220 | | | | | | | | | | | | | | | | | |
| 271 | | 270 | | | | | | | | | | | | | | | | | |
| 331 | | 330 | | | | | | | | | | | | | | | | | |
| 391 | | 390 | | | | | | | | | | | | | | | | | |
| 471 | | 470 | | | | | | | | | | | | | | | | | |
| 561 | | 560 | | | | | | | | | | | | | | | | | |
| 681 | | 680 | | | | | | | | | | | | | | | | | |
| 821 | | 820 | | | | | | | | | | | | | | | | | |
| 102 | | 1000 | | | | | | | | | | | | | | | | | |
| 122 | | 1200 | | | | | | | | | | | | | | | | | |
| 152 | | 1500 | | | | | | | | | | | | | | | | | |
| 182 | | 1800 | | | | | | | | | | | | | | | | | |
| 222 | | 2200 | | | | | | | | | | | | | | | | | |
| 272 | | 2700 | | | | | | | | | | | | | | | | | |
| 332 | | 3300 | | | | | | | | | | | | | | | | | |
| 392 | | 3900 | | | | | | | | | | | | | | | | | |
| 472 | | 4700 | | | | | | | | | | | | | | | | | |
| 562 | | 5600 | | | | | | | | | | | | | | | | | |
| 682 | | 6800 | | | | | | | | | | | | | | | | | |
| 822 | | 8200 | | | | | | | | | | | | | | | | | |
| 103 | Cap | 0.010 | | | | | | | | | | | | | | | | | |
| 123 | (µF) | 0.012 | | | | | | | | | | | | | | | | | |
| 153 | | 0.015 | | | | | | | | | | | | | | | | | |
| 183 | | 0.018 | | | | | | | | | | | | | | | | | |
| 223 | | 0.022 | | | | | | | | | | | | | | | | | |
| 273 | | 0.027 | | | | | | | | | | | | | | | | | |
| 333 | | 0.033 | | | | | | | | | | | | | | | | | |
| 393 | | 0.039 | | | | | | | | | | | | | | | | | |
| 473 | | 0.047 | | | | | | | | | | | | | | | | | |
| 563 | | 0.056 | | | | | | | | | | | | | | | | | |
| 683 | | 0.068 | | | | | | | | | | | | | | | | | |
| 823 | | 0.082 | | | | | | | | | | | | | | | | | |
| 104 | | 0.10 | | | | | | | | | | | | | | | | | |
| 124 | | 0.12 | | | | | | | | | | | | | | | | | |
| 154 | | 0.15 | | | | | | | | | | | | | | | | | |
| 184 | | 0.18 | | | | | | | | | | | | | | | | | |
| 224 | | 0.22 | | | | | | | | | | | | | | | | | |
| 274 | | 0.27 | | | | | | | | | | | | | | | | | |
| 334 | | 0.33 | | | | | | | | | | | | | | | | | |
| 474 | | 0.47 | | | | | | | | | | | | | | | | | |
| 564 | | 0.56 | | | | | | | | | | | | | | | | | |
| 684 | | 0.68 | | | | | | | | | | | | | | | | | |
| 824 | | 0.82 | | | | | | | | | | | | | | | | | |
| 105 | | 1.0 | | | | | | | | | | | | | | | | | |
| 125 | | 1.2 | | | | | | | | | | | | | | | | | |
| 155 | | 1.5 | | | | | | | | | | | | | | | | | |
| 185 | | 1.8 | | | | | | | | | | | | | | | | | |
| 225 | | 2.2 | | | | | | | | | | | | | | | | | |
| 335 | | 3.3 | | | | | | | | | | | | | | | | | |
| 475 | | 4.7 | | | | | | | | | | | | | | | | | |
| 106 | | 10 | | | | | | | | | | | | | | | | | |
| 226 | | 22 | | | | | | | | | | | | | | | | | |
| 476 | | 47 | | | | | | | | | | | | | | | | | |
| 107 | | 100 | | | | | | | | | | | | | | | | | |

Capacitor Array

Automotive Capacitor Array (IPC)

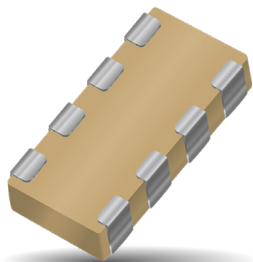

As the market leader in the development and manufacture of capacitor arrays AVX is pleased to offer a range of AEC-Q200 qualified arrays to compliment our product offering to the Automotive industry. Both the AVX 0612 and 0508 4-element capacitor array styles are qualified to the AEC-Q200 automotive specifications.

AEC-Q200 is the Automotive Industry qualification standard and a detailed qualification package is available on request. All AVX automotive capacitor array production facilities are certified to ISO/TS 16949:2002.

HOW TO ORDER

| | | | | | | | | | | |
|--------------------------------------|--|--------------|-----------------------|--|--|--|--|---------------------------------------|---|---|
| W | 3 | A | 4 | Y | C | 104 | K | 4 | T | 2A |
| ↓ | ↓ | ↓ | ↓ | ↓ | ↓ | ↓ | ↓ | ↓ | ↓ | ↓ |
| Style W = RoHS L = SnPb | Case Size 2 = 0508 3 = 0612 | Array | Number of Caps | Voltage Z = 10V Y = 16V 3 = 25V 5 = 50V 1 = 100V | Dielectric A = NP0 C = X7R F = X8R | Capacitance Code (In pF) Significant Digits + Number of Zeros e.g. 10µF=106 | Capacitance Tolerance *J = ±5% *K = ±10% *M = ±20% | Failure Rate 4 = Automotive | Terminations *T = Plated Ni and Sn *Z = FLEXITERM® B = 5% min lead X = FLEXITERM® with 5% min lead | Packaging & Quantity Code 2A = 7" Reel (4000) 4A = 13" Reel (10000) 2F = 7" Reel (1000) |

*RoHS Compliant

*Contact factory for availability by part number for K = ±10% and J = ±5% tolerance.

NP0/COG

| SIZE | W3 = 0612 | | |
|------------------|-------------|----|----|
| | Reflow/Wave | | |
| No. of Elements | 16 | 25 | 50 |
| 1R0 Cap (pF) 1.0 | | | |
| 1R2 1.2 | | | |
| 1R5 1.5 | | | |
| 1R8 1.8 | | | |
| 2R2 2.2 | | | |
| 2R7 2.7 | | | |
| 3R3 3.3 | | | |
| 3R9 3.9 | | | |
| 4R7 4.7 | | | |
| 5R6 5.6 | | | |
| 6R8 6.8 | | | |
| 8R2 8.2 | | | |
| 100 10 | | | |
| 120 12 | | | |
| 150 15 | | | |
| 180 18 | | | |
| 220 22 | | | |
| 270 27 | | | |
| 330 33 | | | |
| 390 39 | | | |
| 470 47 | | | |
| 560 56 | | | |
| 680 68 | | | |
| 820 82 | | | |
| 101 100 | | | |
| 121 120 | | | |
| 151 150 | | | |
| 181 180 | | | |
| 221 220 | | | |
| 271 270 | | | |
| 331 330 | | | |
| 391 390 | | | |
| 471 470 | | | |
| 561 560 | | | |
| 681 680 | | | |
| 821 820 | | | |
| 102 1000 | | | |
| 122 1200 | | | |
| 152 1500 | | | |
| 182 1800 | | | |
| 222 2200 | | | |
| 272 2700 | | | |
| 332 3300 | | | |
| 392 3900 | | | |
| 472 4700 | | | |
| 562 5600 | | | |
| 682 6800 | | | |
| 822 8200 | | | |

 = NP0/COG

X7R

| SIZE | W2 = 0508 | | | | W2 = 0508 | | | | W3 = 0612 | | | | |
|--------------------|-----------|----|----|-----|-----------|----|----|-----|-----------|----|----|----|-----|
| | 2 | | | | 4 | | | | 4 | | | | |
| No. of Elements | 16 | 25 | 50 | 100 | 16 | 25 | 50 | 100 | 10 | 16 | 25 | 50 | 100 |
| 101 Cap (pF) 100 | | | | | | | | | | | | | |
| 121 120 | | | | | | | | | | | | | |
| 151 150 | | | | | | | | | | | | | |
| 181 180 | | | | | | | | | | | | | |
| 221 220 | | | | | | | | | | | | | |
| 271 270 | | | | | | | | | | | | | |
| 331 330 | | | | | | | | | | | | | |
| 391 390 | | | | | | | | | | | | | |
| 471 470 | | | | | | | | | | | | | |
| 561 560 | | | | | | | | | | | | | |
| 681 680 | | | | | | | | | | | | | |
| 821 820 | | | | | | | | | | | | | |
| 102 1000 | | | | | | | | | | | | | |
| 122 1200 | | | | | | | | | | | | | |
| 152 1500 | | | | | | | | | | | | | |
| 182 1800 | | | | | | | | | | | | | |
| 222 2200 | | | | | | | | | | | | | |
| 272 2700 | | | | | | | | | | | | | |
| 332 3300 | | | | | | | | | | | | | |
| 392 3900 | | | | | | | | | | | | | |
| 472 4700 | | | | | | | | | | | | | |
| 562 5600 | | | | | | | | | | | | | |
| 682 6800 | | | | | | | | | | | | | |
| 822 8200 | | | | | | | | | | | | | |
| 103 Cap 0.010 (µF) | | | | | | | | | | | | | |
| 123 0.012 | | | | | | | | | | | | | |
| 153 0.015 | | | | | | | | | | | | | |
| 181 0.018 | | | | | | | | | | | | | |
| 223 0.022 | | | | | | | | | | | | | |
| 273 0.027 | | | | | | | | | | | | | |
| 333 0.033 | | | | | | | | | | | | | |
| 393 0.039 | | | | | | | | | | | | | |
| 473 0.047 | | | | | | | | | | | | | |
| 563 0.056 | | | | | | | | | | | | | |
| 683 0.068 | | | | | | | | | | | | | |
| 823 0.082 | | | | | | | | | | | | | |
| 104 0.10 | | | | | | | | | | | | | |
| 124 0.12 | | | | | | | | | | | | | |
| 154 0.15 | | | | | | | | | | | | | |
| 224 0.22 | | | | | | | | | | | | | |

 = X7R

*Not RoHS Compliant



LEAD-FREE

LEAD-FREE COMPATIBLE COMPONENT



RoHS COMPLIANT

For RoHS compliant products, please select correct termination style.

Capacitor Array

Part & Pad Layout Dimensions

PART & PAD LAYOUT DIMENSIONS

millimeters (inches)

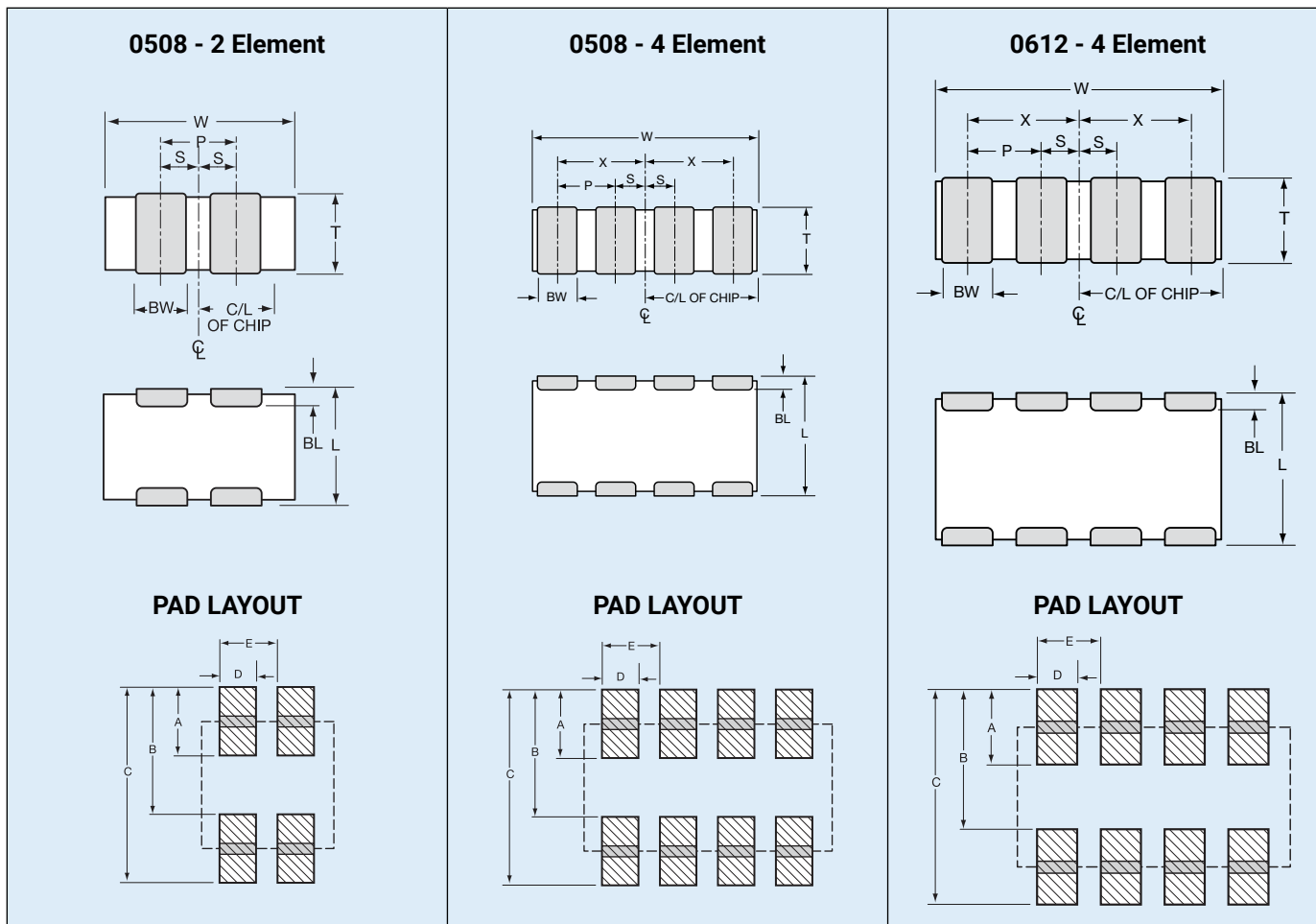

PART DIMENSIONS

0508 - 2 Element

| L | W | T | BW | BL | P | S |
|--------------------------------|--------------------------------|-------------------------|--------------------------------|--------------------------------|-------------------------|--------------------------------|
| 1.30 ± 0.15 (0.051 ± 0.006) | 2.10 ± 0.15 (0.083 ± 0.006) | 0.94 MAX (0.037 MAX) | 0.43 ± 0.10 (0.017 ± 0.004) | 0.33 ± 0.08 (0.013 ± 0.003) | 1.00 REF (0.039 REF) | 0.50 ± 0.10 (0.020 ± 0.004) |

0508 - 4 Element

| L | W | T | BW | BL | P | X | S |
|--------------------------------|--------------------------------|-------------------------|--------------------------------|--------------------------------|-------------------------|--------------------------------|--------------------------------|
| 1.30 ± 0.15 (0.051 ± 0.006) | 2.10 ± 0.15 (0.083 ± 0.006) | 0.94 MAX (0.037 MAX) | 0.25 ± 0.06 (0.010 ± 0.003) | 0.20 ± 0.08 (0.008 ± 0.003) | 0.50 REF (0.020 REF) | 0.75 ± 0.10 (0.030 ± 0.004) | 0.25 ± 0.10 (0.010 ± 0.004) |

0612 - 4 Element

| L | W | T | BW | BL | P | X | S |
|--------------------------------|--------------------------------|-------------------------|--------------------------------|--|-------------------------|--------------------------------|--------------------------------|
| 1.60 ± 0.20 (0.063 ± 0.008) | 3.20 ± 0.20 (0.126 ± 0.008) | 1.35 MAX (0.053 MAX) | 0.41 ± 0.10 (0.016 ± 0.004) | 0.18 ^{+0.25} _{-0.08} (0.007 ^{+0.010} _{-0.003}) | 0.76 REF (0.030 REF) | 1.14 ± 0.10 (0.045 ± 0.004) | 0.38 ± 0.10 (0.015 ± 0.004) |

PAD LAYOUT DIMENSIONS

0508 - 2 Element

| A | B | C | D | E |
|-----------------|-----------------|-----------------|-----------------|-----------------|
| 0.68 (0.027) | 1.32 (0.052) | 2.00 (0.079) | 0.46 (0.018) | 1.00 (0.039) |

0508 - 4 Element

| A | B | C | D | E |
|-----------------|-----------------|-----------------|-----------------|-----------------|
| 0.56 (0.022) | 1.32 (0.052) | 1.88 (0.074) | 0.30 (0.012) | 0.50 (0.020) |

0612 - 4 Element

| A | B | C | D | E |
|-----------------|-----------------|-----------------|-----------------|-----------------|
| 0.89 (0.035) | 1.65 (0.065) | 2.54 (0.100) | 0.46 (0.018) | 0.76 (0.030) |

Low Inductance Capacitors

Introduction

The signal integrity characteristics of a Power Delivery Network (PDN) are becoming critical aspects of board level and semiconductor package designs due to higher operating frequencies, larger power demands, and the ever shrinking lower and upper voltage limits around low operating voltages. These power system challenges are coming from mainstream designs with operating frequencies of 300MHz or greater, modest ICs with power demand of 15 watts or more, and operating voltages below 3 volts.

The classic PDN topology is comprised of a series of capacitor stages. Figure 1 is an example of this architecture with multiple capacitor stages.

An ideal capacitor can transfer all its stored energy to a load instantly. A real capacitor has parasitics that prevent instantaneous transfer of a capacitor's stored energy. The true nature of a capacitor can be modeled as an RLC equivalent circuit. For most simulation purposes, it is possible to model the characteristics of a real capacitor with one capacitor, one resistor, and one inductor. The RLC values in this model are commonly referred to as equivalent series capacitance (ESC), equivalent series resistance (ESR), and equivalent series inductance (ESL).

The ESL of a capacitor determines the speed of energy transfer to a load. The lower the ESL of a capacitor, the faster that energy can be transferred to a load. Historically, there has been a tradeoff between energy storage (capacitance) and inductance (speed of energy delivery). Low ESL devices typically have low capacitance. Likewise, higher capacitance devices typically have higher ESLs. This tradeoff between ESL (speed of energy delivery) and capacitance (energy storage) drives the PDN design topology that places the fastest low ESL capacitors as close to the load as possible. Low Inductance MLCCs are found on semiconductor packages and on boards as close as possible to the load.

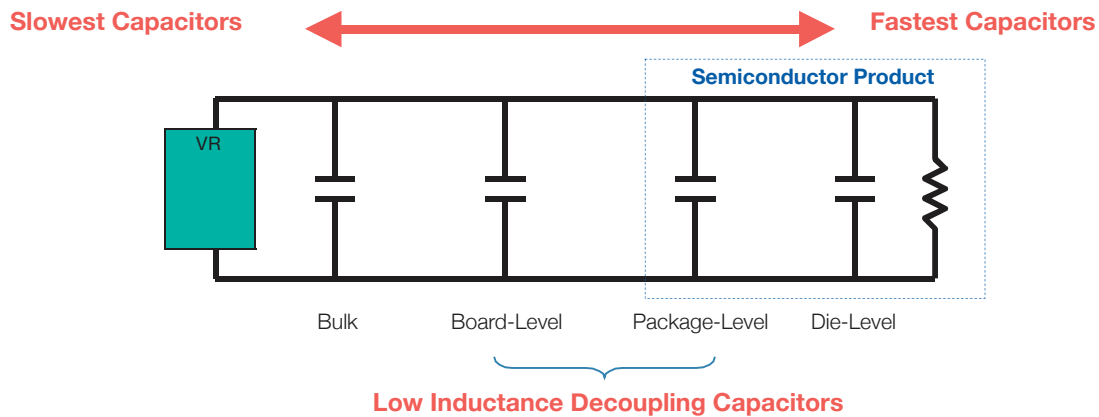

Figure 1 Classic Power Delivery Network (PDN) Architecture

LOW INDUCTANCE CHIP CAPACITORS

The key physical characteristic determining equivalent series inductance (ESL) of a capacitor is the size of the current loop it creates. The smaller the current loop, the lower the ESL. A standard surface mount MLCC is rectangular in shape with electrical terminations on its shorter sides. A Low Inductance Chip Capacitor (LICC) sometimes referred to as Reverse Geometry Capacitor (RGC) has its terminations on the longer side of its rectangular shape.

When the distance between terminations is reduced, the size of the current loop is reduced. Since the size of the current loop is the primary driver of inductance, an 0306 with a smaller current loop has significantly lower ESL than an 0603. The reduction in ESL varies by EIA size, however, ESL is typically reduced 60% or more with an LICC versus a standard MLCC.

INTERDIGITATED CAPACITORS

The size of a current loop has the greatest impact on the ESL characteristics of a surface mount capacitor. There is a secondary method for decreasing the ESL of a capacitor. This secondary method uses adjacent opposing current loops to reduce ESL. The InterDigitated Capacitor (IDC) utilizes both primary and secondary methods of reducing inductance. The IDC architecture shrinks the distance between terminations to minimize the current loop size, then further reduces inductance by creating adjacent opposing current loops.

An IDC is one single capacitor with an internal structure that has been optimized for low ESL. Similar to standard MLCC versus LICCs, the reduction in ESL varies by EIA case size. Typically, for the same EIA size, an IDC delivers an ESL that is at least 80% lower than an MLCC.

Low Inductance Capacitors

Introduction

LAND GRID ARRAY (LGA) CAPACITORS

Land Grid Array (LGA) capacitors are based on the first Low ESL MLCC technology created to specifically address the design needs of current day Power Delivery Networks (PDNs). This is the 3rd low inductance capacitor technology developed by AVX. LGA technology provides engineers with new options. The LGA internal structure and manufacturing technology eliminates the historic need for a device to be physically small to create small current loops to minimize inductance.

The first family of LGA products are 2 terminal devices. A 2 terminal 0306 LGA delivers ESL performance that is equal to or better than an 0306 8 terminal IDC. The 2 terminal 0805 LGA delivers ESL performance that approaches the 0508 8 terminal IDC. New designs that would have used 8 terminal IDCs are moving to 2 terminal LGAs because the layout is easier for a 2 terminal device and manufacturing yield is better for a 2 terminal LGA versus an 8 terminal IDC.

LGA technology is also used in a 4 terminal family of products that AVX is sampling and will formerly introduce in 2008. Beyond 2008, there are new multi-terminal LGA product families that will provide even more attractive options for PDN designers.

LOW INDUCTANCE CHIP ARRAYS (LICA®)

The LICA® product family is the result of a joint development effort between AVX and IBM to develop a high performance MLCC family of decoupling capacitors. LICA was introduced in the 1980s and remains the leading choice of designers in high performance semiconductor packages and high reliability board level decoupling applications.

LICA® products are used in 99.999% uptime semiconductor package applications on both ceramic and organic substrates. The C4 solder ball termination option is the perfect compliment to flip-chip packaging technology. Mainframe class CPUs, ultimate performance multi-chip modules, and communications systems that must have the reliability of 5 9's use LICA®.

LICA® products with either Sn/Pb or Pb-free solder balls are used for decoupling in high reliability military and aerospace applications. These LICA® devices are used for decoupling of large pin count FPGAs, ASICs, CPUs, and other high power ICs with low operating voltages.

When high reliability decoupling applications require the very lowest ESL capacitors, LICA® products are the best option.

470 nF 0306 Impedance Comparison

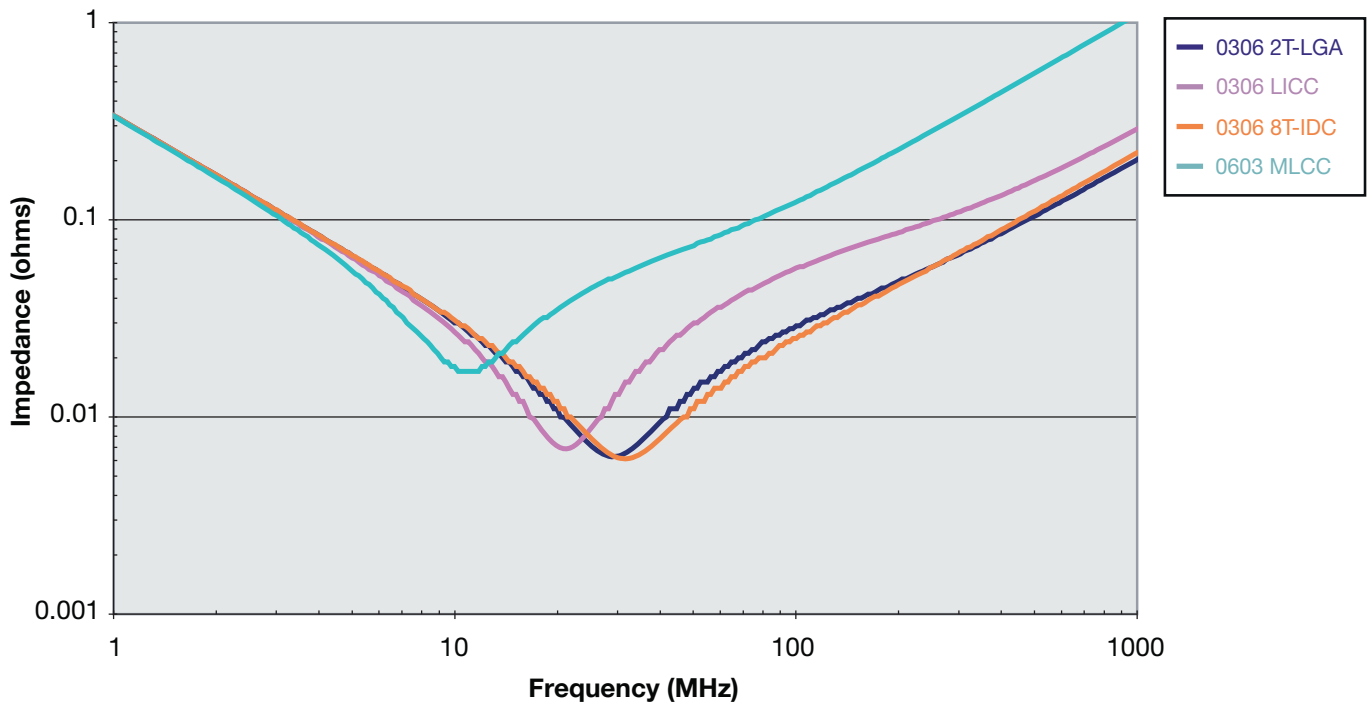

Figure 2 MLCC, LICC, IDC, and LGA technologies deliver different levels of equivalent series inductance (ESL).

Low Inductance Ceramic Capacitors

LICC (Low Inductance Chip Capacitors) 0306/0508/0612 RoHS Compliant



GENERAL DESCRIPTION

The key physical characteristic determining equivalent series inductance (ESL) of a capacitor is the size of the current loop it creates. The smaller the current loop, the lower the ESL.

A standard surface mount MLCC is rectangular in shape with electrical terminations on its shorter sides. A Low Inductance Chip Capacitor (LICC) sometimes referred to as Reverse Geometry Capacitor (RGC) has its terminations on the longer sides of its rectangular shape. The image on the right shows the termination differences between an MLCC and an LICC.

When the distance between terminations is reduced, the size of the current loop is reduced. Since the size of the current loop is the primary driver of inductance, an 0306 with a smaller current loop has significantly lower ESL than an 0603. The reduction in ESL varies by EIA size, however, ESL is typically reduced 60% or more with an LICC versus a standard MLCC.

AVX LICC products are available with a lead-free finish of plated Nickel/Tin.

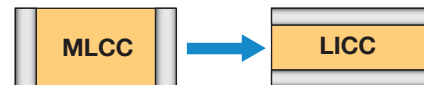
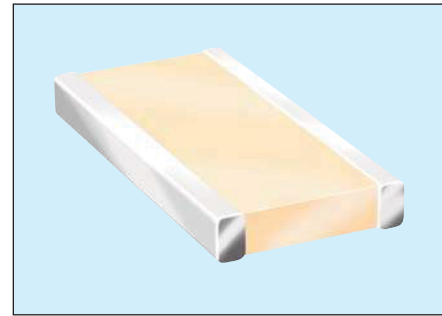

PERFORMANCE CHARACTERISTICS

| | |
|---|--|
| Capacitance Tolerances | K = $\pm 10\%$; M = $\pm 20\%$ |
| Operation Temperature Range | X7R = -55°C to $+125^\circ\text{C}$ X5R = -55°C to $+85^\circ\text{C}$ X7S = -55°C to $+125^\circ\text{C}$ |
| Temperature Coefficient | X7R, X5R = $\pm 15\%$; X7S = $\pm 22\%$ |
| Voltage Ratings | 4, 6.3, 10, 16, 25 VDC |
| Dissipation Factor | 4V, 6.3V = 6.5% max; 10V = 5.0% max; 16V = 3.5% max; 25V = 3.0% max |
| Insulation Resistance (@+25°C, RVDC) | 100,000M Ω min, or 1,000M Ω per μF min, whichever is less |



HOW TO ORDER

0612

Size
0306
0508
0612

Z

Voltage
4 = 4V
6 = 6.3V
Z = 10V
Y = 16V
3 = 25V
5 = 50V

D

Dielectric
C = X7R
D = X5R
W = X6S
Z = X7S

105

Capacitance Code (In pF)
2 Sig. Digits +
Number of Zeros

M

Capacitance Tolerance
K = $\pm 10\%$
M = $\pm 20\%$

A

Failure Rate
A = N/A
4 = Automotive**

T

Terminations
T = Plated Ni
and Sn

2

Packaging Available
2 = 7" Reel
4 = 13" Reel

A*

Thickness
Thickness
mm (in)
0.56 (0.022)
0.76 (0.030)
1.02 (0.040)
1.27 (0.050)

*See the thickness tables on the next page.

**Select voltages for Automotive version, contact factory

NOTE: Contact factory for availability of Termination and Tolerance Options for Specific Part Numbers.

TYPICAL IMPEDANCE CHARACTERISTICS

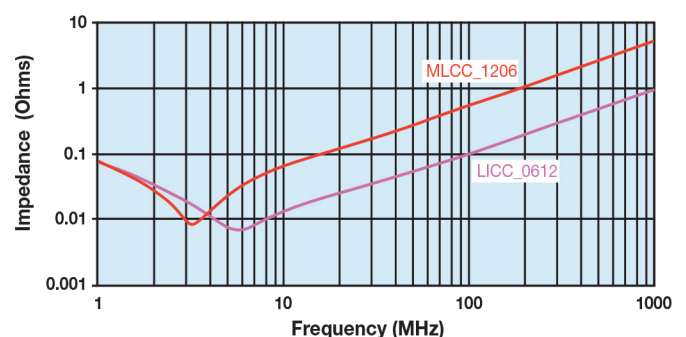
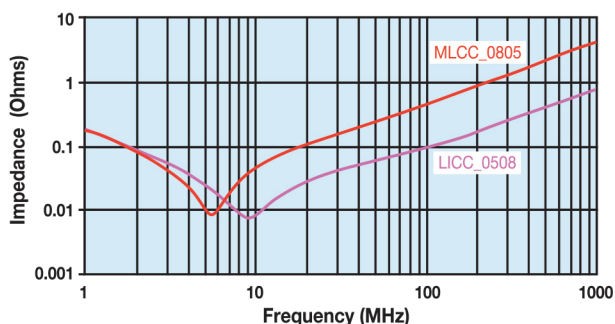

Low Inductance Ceramic Capacitors

LICC (Low Inductance Chip Capacitors) 0306/0508/0612 RoHS Compliant



| SIZE | | 0306 | | | | | 0508 | | | | | 0612 | | | | |
|-----------|------------|-----------------|-----|----|----|----|-----------------|----|----|----|----|-----------------|----|----|----|----|
| Packaging | | Embossed | | | | | Embossed | | | | | Embossed | | | | |
| Length | mm | 0.81 + 0.15 | | | | | 1.27 + 0.25 | | | | | 1.60 + 0.25 | | | | |
| | (in.) | (0.032 ± 0.006) | | | | | (0.050 ± 0.010) | | | | | (0.063 ± 0.010) | | | | |
| Width | mm | 1.60 + 0.15 | | | | | 2.00 + 0.25 | | | | | 3.20 + 0.25 | | | | |
| | (in.) | (0.063 ± 0.006) | | | | | (0.080 ± 0.010) | | | | | (0.126 ± 0.010) | | | | |
| Cap Code | WVDC | 4 | 6.3 | 10 | 16 | 25 | 6.3 | 10 | 16 | 25 | 50 | 6.3 | 10 | 16 | 25 | 50 |
| | 102 | Cap 0.001 | A | A | A | A | S | S | S | S | V | S | S | S | S | V |
| 222 | (µF) .0022 | A | A | A | A | S | S | S | S | V | S | S | S | S | V | |
| 332 | 0.0033 | A | A | A | A | S | S | S | S | V | S | S | S | S | V | |
| 472 | 0.0047 | A | A | A | A | S | S | S | S | V | S | S | S | S | V | |
| 682 | 0.0068 | A | A | A | A | S | S | S | S | V | S | S | S | S | V | |
| 103 | 0.01 | A | A | A | A | S | S | S | S | V | S | S | S | S | V | |
| 153 | 0.015 | A | A | A | A | S | S | S | S | V | S | S | S | S | W | |
| 223 | 0.022 | A | A | A | A | S | S | S | S | V | S | S | S | S | W | |
| 333 | 0.033 | A | A | A | | S | S | S | V | V | S | S | S | S | W | |
| 473 | 0.047 | A | A | A | | S | S | S | V | A | S | S | S | S | W | |
| 683 | 0.068 | A | A | | | S | S | S | A | A | S | S | S | V | W | |
| 104 | 0.1 | A | A | A | | S | S | V | A | A | S | S | S | V | W | |
| 154 | 0.15 | A | A | | | S | S | V | | | S | S | S | W | W | |
| 224 | 0.22 | A | A | | | S | S | A | | | S | S | V | W | | |
| 334 | 0.33 | | | | | V | V | | | | S | S | V | | | |
| 474 | 0.47 | | | | | V | V | A | | | S | S | V | | | |
| 684 | 0.68 | | | | | A | A | | | | V | V | W | | | |
| 105 | 1 | A | | | | | A | | | | V | V | A | | | |
| 155 | 1.5 | | | | | A | | | | | W | W | | | | |
| 225 | 2.2 | | | | | | | | | | A | A | | | | |
| 335 | 3.3 | | | | | | | | | | A | | | | | |
| 475 | 4.7 | | | | | | | | | | | | | | | |
| 685 | 6.8 | | | | | | | | | | | | | | | |
| 106 | 10 | | | | | | | | | | | | | | | |

Solid = X7R = X5R = X7S = X6S

mm (in.)

| 0306 | |
|------|--------------|
| Code | Thickness |
| A | 0.56 (0.022) |

mm (in.)

| 0508 | |
|------|--------------|
| Code | Thickness |
| S | 0.56 (0.022) |
| V | 0.76 (0.030) |
| A | 1.02 (0.040) |

mm (in.)

| 0612 | |
|------|--------------|
| Code | Thickness |
| S | 0.56 (0.022) |
| V | 0.76 (0.030) |
| W | 1.02 (0.040) |
| A | 1.27 (0.050) |

PHYSICAL DIMENSIONS AND PAD LAYOUT

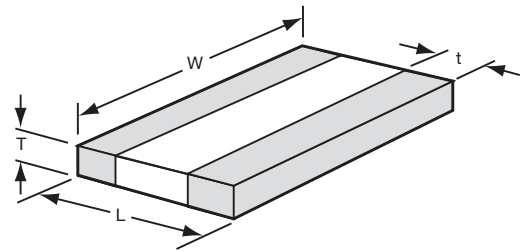

PHYSICAL DIMENSIONS

| Size | mm (in.) | | |
|------|-----------------|-----------------|--------------|
| | L | W | t |
| 0306 | 0.81 ± 0.15 | 1.60 ± 0.15 | 0.13 min. |
| | (0.032 ± 0.006) | (0.063 ± 0.006) | (0.005 min.) |
| 0508 | 1.27 ± 0.25 | 2.00 ± 0.25 | 0.13 min. |
| | (0.050 ± 0.010) | (0.080 ± 0.010) | (0.005 min.) |
| 0612 | 1.60 ± 0.25 | 3.20 ± 0.25 | 0.13 min. |
| | (0.063 ± 0.010) | (0.126 ± 0.010) | (0.005 min.) |

T - See Range Chart for Thickness and Codes

PAD LAYOUT DIMENSIONS

| Size | mm (in.) | | |
|------|--------------|--------------|---------------|
| | A | B | C |
| 0306 | 0.31 (0.012) | 1.52 (0.060) | 0.51 (0.020) |
| 0508 | 0.51 (0.020) | 2.03 (0.080) | 0.76 (0.030) |
| 0612 | 0.76 (0.030) | 3.05 (0.120) | 0.635 (0.025) |

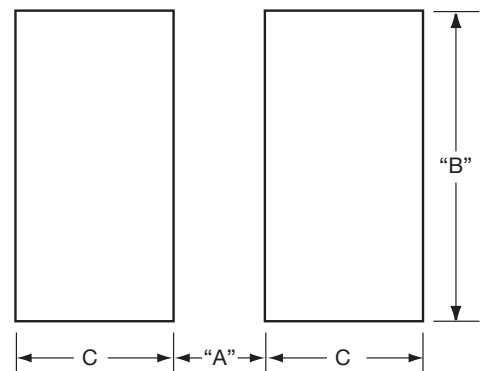

Low Inductance Capacitors with SnPb Terminations

LD16/LD17/LD18 Tin-Lead Termination "B"

GENERAL DESCRIPTION

The key physical characteristic determining equivalent series inductance (ESL) of a capacitor is the size of the current loop it creates. The smaller the current loop, the lower the ESL.

A standard surface mount MLCC is rectangular in shape with electrical terminations on its shorter sides. A Low Inductance Chip Capacitor (LICC) sometimes referred to as Reverse Geometry Capacitor (RGC) has its terminations on the longer sides of its rectangular shape. The image on the right shows the termination differences between an MLCC and an LICC.

When the distance between terminations is reduced, the size of the current loop is reduced. Since the size of the current loop is the primary driver of inductance, an 0306 with a smaller current loop has significantly lower ESL than an 0603. The reduction in ESL varies by EIA size, however, ESL is typically reduced 60% or more with an LICC versus a standard MLCC.

AVX LICC products are available with a lead termination for high reliability military and aerospace applications that must avoid tin whisker reliability issues.

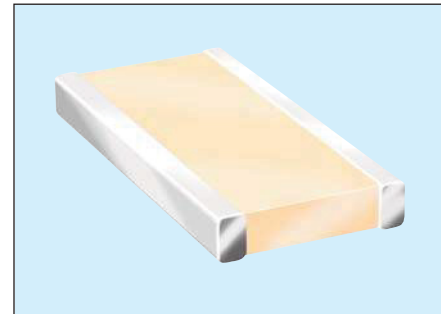

PERFORMANCE CHARACTERISTICS

| | |
|---|--|
| Capacitance Tolerances | K = $\pm 10\%$; M = $\pm 20\%$ |
| Operation Temperature Range | X7R = -55°C to $+125^{\circ}\text{C}$ X5R = -55°C to $+85^{\circ}\text{C}$ X7S = -55°C to $+125^{\circ}\text{C}$ |
| Temperature Coefficient | X7R, X5R = $\pm 15\%$; X7S = $\pm 22\%$ |
| Voltage Ratings | 4, 6.3, 10, 16, 25 VDC |
| Dissipation Factor | 4V, 6.3V = 6.5% max; 10V = 5.0% max; 16V = 3.5% max; 25V = 3.0% max |
| Insulation Resistance (@+25°C, RVDC) | 100,000M Ω min, or 1,000M Ω per μF min., whichever is less |

***Not RoHS Compliant**

HOW TO ORDER

| | | | | | | | | |
|---|--|--|------------------------------------|----------------------------------|--------------|-----------------|-----------------------------|---|
| LD18 | Z | D | 105 | M | A | B | 2 | A* |
| Size | Voltage | Dielectric | Capacitance Code (In pF) | Capacitance Tolerance | Failure Rate | Terminations | Packaging Available | Thickness |
| LD16 = 0306 LD17 = 0508 LD18 = 0612 | 4 = 4V 6 = 6.3V Z = 10V Y = 16V 3 = 25V 5 = 50V | C = X7R D = X5R W = X6S Z = X7S | 2 Sig. Digits + Number of Zeros | K = $\pm 10\%$ M = $\pm 20\%$ | A = N/A | B = 5% min lead | 2 = 7" Reel 4 = 13" Reel | mm (in) 0.56 (0.022) 0.76 (0.030) 1.02 (0.040) 1.27 (0.050) |

*See the thickness tables on the next page.

NOTE: Contact factory for availability of Termination and Tolerance Options for Specific Part Numbers.

TYPICAL IMPEDANCE CHARACTERISTICS

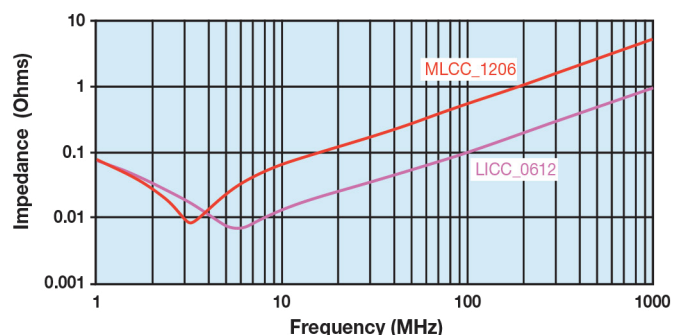
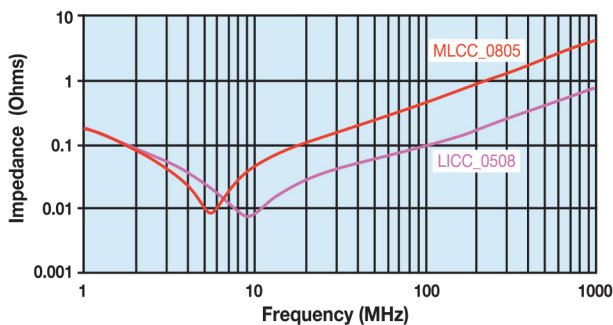

Low Inductance Capacitors with SnPb Terminations

LD16/LD17/LD18 Tin-Lead Termination "B"



| SIZE | | LD16 (0306) | | | | LD17 (0508) | | | | | LD18 (0612) | | | | |
|-----------|------------|-----------------------------|----|----|----|-----------------------------|----|----|----|----|-----------------------------|----|----|----|----|
| Packaging | | Embossed | | | | Embossed | | | | | Embossed | | | | |
| Length | mm (in.) | 0.81 ± 0.15 (0.032 ± 0.006) | | | | 1.27 ± 0.25 (0.050 ± 0.010) | | | | | 1.60 ± 0.25 (0.063 ± 0.010) | | | | |
| Width | mm (in.) | 1.60 ± 0.15 (0.063 ± 0.006) | | | | 2.00 ± 0.25 (0.080 ± 0.010) | | | | | 3.20 ± 0.25 (0.126 ± 0.010) | | | | |
| Cap Code | WVDC | 6.3 | 10 | 16 | 25 | 6.3 | 10 | 16 | 25 | 50 | 6.3 | 10 | 16 | 25 | 50 |
| 102 | Cap 0.001 | A | A | A | A | S | S | S | S | V | S | S | S | S | V |
| 222 | (µF) .0022 | A | A | A | A | S | S | S | S | V | S | S | S | S | V |
| 332 | 0.0033 | A | A | A | A | S | S | S | S | V | S | S | S | S | V |
| 472 | 0.0047 | A | A | A | A | S | S | S | S | V | S | S | S | S | V |
| 682 | 0.0068 | A | A | A | A | S | S | S | S | V | S | S | S | S | V |
| 103 | 0.01 | A | A | A | A | S | S | S | S | V | S | S | S | S | V |
| 153 | 0.015 | A | A | A | A | S | S | S | S | V | S | S | S | S | W |
| 223 | 0.022 | A | A | A | A | S | S | S | S | V | S | S | S | S | W |
| 333 | 0.033 | A | A | A | | S | S | S | V | V | S | S | S | S | W |
| 473 | 0.047 | A | A | A | | S | S | S | V | A | S | S | S | S | W |
| 683 | 0.068 | A | A | X | | S | S | S | A | A | S | S | S | V | W |
| 104 | 0.1 | A | A | X | | S | S | V | A | A | S | S | S | V | W |
| 154 | 0.15 | A | A | X | | S | S | V | | | S | S | S | W | W |
| 224 | 0.22 | A | A | | | S | S | A | | | S | S | V | W | |
| 334 | 0.33 | | | | | V | V | A | | | S | S | V | | |
| 474 | 0.47 | | | | | V | V | X | | | S | S | V | | |
| 684 | 0.68 | | | | | A | A | | | | V | V | W | | |
| 105 | 1 | | | | | X | A | | | | V | V | A | | |
| 155 | 1.5 | | | | | X | | | | | W | W | | | |
| 225 | 2.2 | | | | | | | | | | A | A | | | |
| 335 | 3.3 | | | | | | | | | | X | A | | | |
| 475 | 4.7 | | | | | | | | | | | | | | |
| 685 | 6.8 | | | | | | | | | | | | | | |
| 106 | 10 | | | | | | | | | | | | | | |

PHYSICAL DIMENSIONS AND PAD LAYOUT

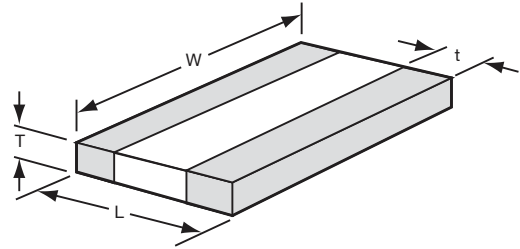

PHYSICAL DIMENSIONS

| Size | L | W | t |
|--------------------|-----------------------------|-----------------------------|------------------------|
| LD16 (0306) | 0.81 ± 0.15 (0.032 ± 0.006) | 1.60 ± 0.15 (0.063 ± 0.006) | 0.13 min. (0.005 min.) |
| LD17 (0508) | 1.27 ± 0.25 (0.050 ± 0.010) | 2.00 ± 0.25 (0.080 ± 0.010) | 0.13 min. (0.005 min.) |
| LD18 (0612) | 1.60 ± 0.25 (0.063 ± 0.010) | 3.20 ± 0.25 (0.126 ± 0.010) | 0.13 min. (0.005 min.) |

T - See Range Chart for Thickness and Codes

PAD LAYOUT DIMENSIONS

| Size | A | B | C |
|--------------------|--------------|--------------|---------------|
| LD16 (0306) | 0.31 (0.012) | 1.52 (0.060) | 0.51 (0.020) |
| LD17 (0508) | 0.51 (0.020) | 2.03 (0.080) | 0.76 (0.030) |
| LD18 (0612) | 0.76 (0.030) | 3.05 (0.120) | 0.635 (0.025) |

Solid = X7R

X = X5R

X = X6S

| LD16 (0306) | |
|-------------|--------------|
| Code | Thickness |
| A | 0.56 (0.022) |

| LD17 (0508) | |
|-------------|--------------|
| Code | Thickness |
| S | 0.56 (0.022) |
| V | 0.76 (0.030) |
| A | 1.02 (0.040) |

| LD18 (0612) | |
|-------------|--------------|
| Code | Thickness |
| S | 0.56 (0.022) |
| V | 0.76 (0.030) |
| W | 1.02 (0.040) |
| A | 1.27 (0.050) |

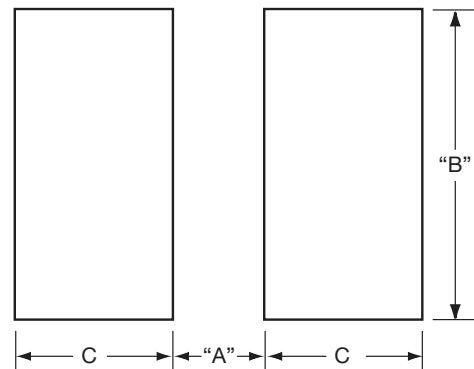

IDC Low Inductance Capacitors (RoHS)

IDC (InterDigitated Capacitors) 0306/0612/0508

GENERAL DESCRIPTION

Inter-Digitated Capacitors (IDCs) are used for both semiconductor package and board level decoupling. The equivalent series inductance (ESL) of a single capacitor or an array of capacitors in parallel determines the response time of a Power Delivery Network (PDN). The lower the ESL of a PDN, the faster the response time. A designer can use many standard MLCCs in parallel to reduce ESL or a low ESL Inter-Digitated Capacitor (IDC) device. These IDC devices are available in versions with a maximum height of 0.95mm or 0.55mm.

IDCs are typically used on packages of semiconductor products with power levels of 15 watts or greater. Inter-Digitated Capacitors are used on CPU, GPU, ASIC, and ASSP devices produced on 0.13μ, 90nm, 65nm, and 45nm processes. IDC devices are used on both ceramic and organic package substrates. These low ESL surface mount capacitors can be placed on the bottom side or the top side of a package substrate. The low profile 0.55mm maximum height IDCs can easily be used on the bottom side of BGA packages or on the die side of packages under a heat spreader.

IDCs are used for board level decoupling of systems with speeds of 300MHz or greater. Low ESL IDCs free up valuable board space by reducing the number of capacitors required versus standard MLCCs. There are additional benefits to reducing the number of capacitors beyond saving board space including higher reliability from a reduction in the number of components and lower placement costs based on the need for fewer capacitors.

The Inter-Digitated Capacitor (IDC) technology was developed by AVX. This is the second family of Low Inductance MLCC products created by AVX. IDCs are a cost effective alternative to AVX's first generation low ESL family for high-reliability applications known as LICA (Low Inductance Chip Array).

AVX IDC products are available with a lead-free finish of plated Nickel/Tin.

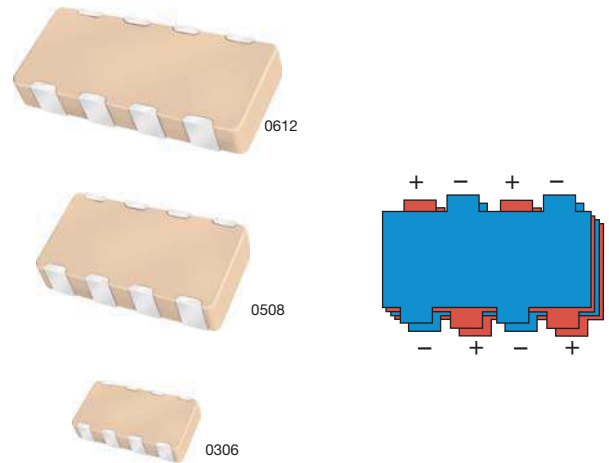

TYPICAL IMPEDANCE

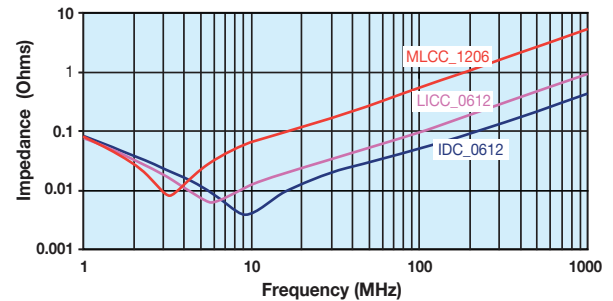

HOW TO ORDER

| | | | | | | | | | | | |
|----------|----------------------------------|----------------|---------------------|---|-------------------------------|---------------------------------|-----------------------|--------------|----------------------|-----------------------------|---|
| W | 3 | L | 1 | 6 | D | 225 | M | A | T | 3 | A |
| Style | IDC Case Size | Low Inductance | Number of Terminals | Voltage | Dielectric | Capacitance Code (In pF) | Capacitance Tolerance | Failure Rate | Termination | Packaging Available | Thickness Max. Thickness |
| | 2 = 0508 3 = 0612 4 = 0306 | | 1 = 8 Terminals | 4 = 4V 6 = 6.3V Z = 10V Y = 16V 3 = 25V | C = X7R D = X5R Z = X7S | 2 Sig. Digits + Number of Zeros | M = ±20% | A = N/A | T = Plated Ni and Sn | 1 = 7" Reel 3 = 13" Reel | mm (in) A = Standard S = 0.55 (0.022) |

NOTE: Contact factory for availability of Termination and Tolerance Options for Specific Part Numbers.



PERFORMANCE CHARACTERISTICS

| | |
|---|--|
| Capacitance Tolerance | ±20% Preferred |
| Operation Temperature Range | X7R = -55°C to +125°C X5R = -55°C to +85°C X7S = -55°C to +125°C |
| Temperature Coefficient | ±15% (0VDC), ±22% (X7S) |
| Voltage Ratings | 4, 6.3, 10, 16, 25 VDC |
| Dissipation Factor | ≤ 6.3V = 6.5% max; 10V = 5.0% max; ≥ 16V = 3.5% max |
| Insulation Resistance (@+25°C, RVDC) | 100,000MΩ min, or 1,000MΩ per μF min., whichever is less |

| | |
|-------------------------------|---|
| Dissipation Factor | No problems observed after 2.5 x RVDC for 5 seconds at 50mA max current |
| CTE (ppm/C) | 12.0 |
| Thermal Conductivity | 4-5W/M K |
| Terminations Available | Plated Nickel and Solder |

IDC Low Inductance Capacitors (RoHS)

IDC (InterDigitated Capacitors) 0306/0612/0508

| SIZE | W4 = 0306 | | W2 = Thin 0508 | | | | | W2 = 0508 | | | | | W3= Thin 0612 | | | | W3 = 0612 | | | | | W3 = THICK 0612 | | | | |
|----------------|-----------------|-----|-----------------|-----|----|----|----|-----------------|-----|----|----|----|-----------------|-----|----|----|-----------------|-----|----|----|----|-----------------|-----|----|----|--|
| Max. Thickness | 0.55 (0.022) | | 0.55 (0.022) | | | | | 0.95 (0.037) | | | | | 0.55 (0.022) | | | | 0.95 (0.037) | | | | | 1.22 (0.048) | | | | |
| WVDC | 4 | 6.3 | 4 | 6.3 | 10 | 16 | 25 | 4 | 6.3 | 10 | 16 | 25 | 4 | 6.3 | 10 | 16 | 4 | 6.3 | 10 | 16 | 25 | 4 | 6.3 | 10 | 16 | |
| Cap (µF) | 0.010 | | | | | | | | | | | | | | | | | | | | | | | | | |
| | 0.022 | | | | | | | | | | | | | | | | | | | | | | | | | |
| | 0.033 | | | | | | | | | | | | | | | | | | | | | | | | | |
| | 0.047 | | | | | | | | | | | | | | | | | | | | | | | | | |
| | 0.068 | | | | | | | | | | | | | | | | | | | | | | | | | |
| | 0.10 | | | | | | | | | | | | | | | | | | | | | | | | | |
| | 0.22 | | | | | | | | | | | | | | | | | | | | | | | | | |
| | 0.33 | | | | | | | | | | | | | | | | | | | | | | | | | |
| | 0.47 | | | | | | | | | | | | | | | | | | | | | | | | | |
| | 0.68 | | | | | | | | | | | | | | | | | | | | | | | | | |
| | 1.0 | | | | | | | | | | | | | | | | | | | | | | | | | |
| | 1.5 | | | | | | | | | | | | | | | | | | | | | | | | | |
| | 2.2 | | | | | | | | | | | | | | | | | | | | | | | | | |
| | 3.3 | | | | | | | | | | | | | | | | | | | | | | | | | |

PHYSICAL DIMENSIONS AND PAD LAYOUT

Consult factory for additional requirements

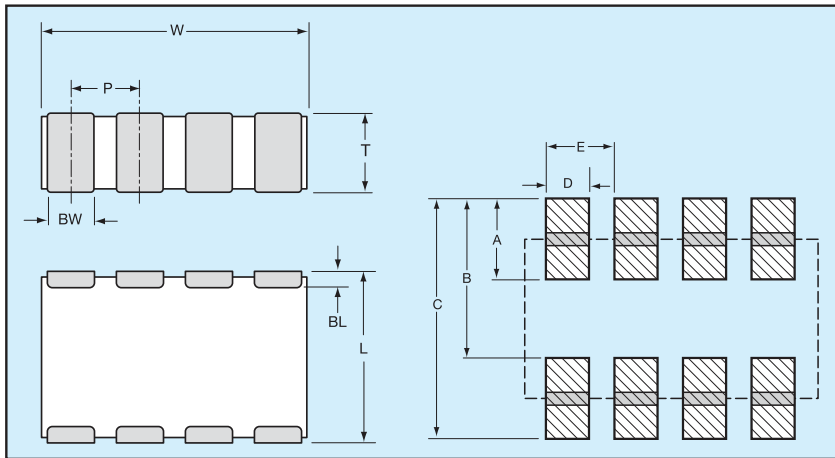

- = X7R
- = X5R
- = X7S

PHYSICAL CHIP DIMENSIONS

MILLIMETERS (INCHES)

| SIZE | W | L | BW | BL | P |
|-------------|--------------------------------|--------------------------------|--------------------------------|--------------------------------|--------------------------------|
| 0306 | 1.60 ± 0.20 (0.063 ± 0.008) | 0.82 ± 0.10 (0.032 ± 0.006) | 0.25 ± 0.10 (0.010 ± 0.004) | 0.20 ± 0.10 (0.008 ± 0.004) | 0.40 ± 0.05 (0.015 ± 0.002) |
| 0508 | 2.03 ± 0.20 (0.080 ± 0.008) | 1.27 ± 0.20 (0.050 ± 0.008) | 0.30 ± 0.10 (0.012 ± 0.004) | 0.25 ± 0.15 (0.010 ± 0.006) | 0.50 ± 0.05 (0.020 ± 0.002) |
| 0612 | 3.20 ± 0.20 (0.126 ± 0.008) | 1.60 ± 0.20 (0.063 ± 0.008) | 0.50 ± 0.10 (0.020 ± 0.004) | 0.25 ± 0.15 (0.010 ± 0.006) | 0.80 ± 0.10 (0.031 ± 0.004) |

PAD LAYOUT DIMENSIONS

| SIZE | A | B | C | D | E |
|-------------|-----------------|-----------------|-----------------|-----------------|-----------------|
| 0306 | 0.38 (0.015) | 0.89 (0.035) | 1.27 (0.050) | 0.20 (0.008) | 0.40 (0.015) |
| 0508 | 0.64 (0.025) | 1.27 (0.050) | 1.91 (0.075) | 0.28 (0.011) | 0.50 (0.020) |
| 0612 | 0.89 (0.035) | 1.65 (0.065) | 2.54 (0.101) | 0.45 (0.018) | 0.80 (0.031) |

IDC Low Inductance Capacitors (SnPb)

IDC (InterDigitated Capacitors) 0306/0612/0508



GENERAL DESCRIPTION

Inter-Digitated Capacitors (IDCs) are used for both semiconductor package and board level decoupling. The equivalent series inductance (ESL) of a single capacitor or an array of capacitors in parallel determines the response time of a Power Delivery Network (PDN). The lower the ESL of a PDN, the faster the response time. A designer can use many standard MLCCs in parallel to reduce ESL or a low ESL Inter-Digitated Capacitor (IDC) device. These IDC devices are available in versions with a maximum height of 0.95mm or 0.55mm.

IDCs are typically used on packages of semiconductor products with power levels of 15 watts or greater. Inter-Digitated Capacitors are used on CPU, GPU, ASIC, and ASSP devices produced on 0.13μ, 90nm, 65nm, and 45nm processes. IDC devices are used on both ceramic and organic package substrates. These low ESL surface mount capacitors can be placed on the bottom side or the top side of a package substrate. The low profile 0.55mm maximum height IDCs can easily be used on the bottom side of BGA packages or on the die side of packages under a heat spreader.

IDCs are used for board level decoupling of systems with speeds of 300MHz or greater. Low ESL IDCs free up valuable board space by reducing the number of capacitors required versus standard MLCCs. There are additional benefits to reducing the number of capacitors beyond saving board space including higher reliability from a reduction in the number of components and lower placement costs based on the need for fewer capacitors.

The Inter-Digitated Capacitor (IDC) technology was developed by AVX. This is the second family of Low Inductance MLCC products created by AVX. IDCs are a cost effective alternative to AVX's first generation low ESL family for high-reliability applications known as LICA (Low Inductance Chip Array).

AVX IDC products are available with a lead termination for high reliability military and aerospace applications that must avoid tin whisker reliability issues.

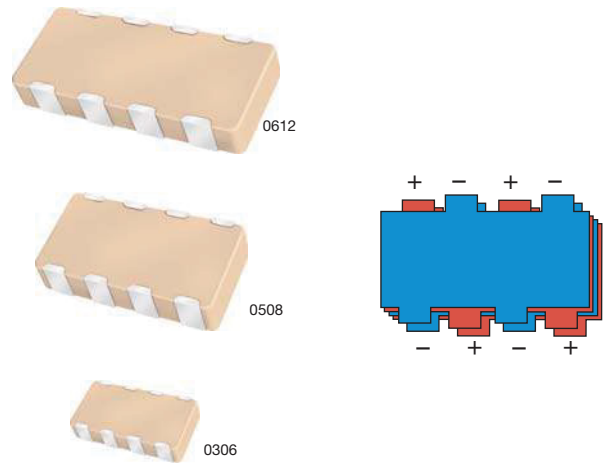

TYPICAL IMPEDANCE

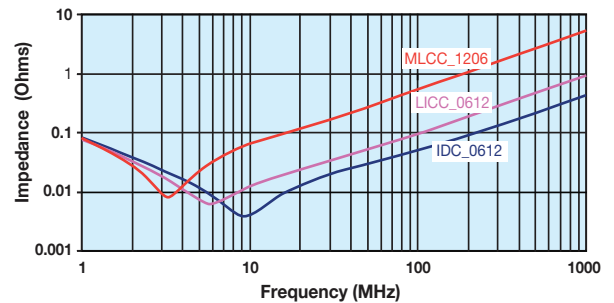

HOW TO ORDER

| | | | | | | | | | | | |
|--------------|----------------------------------|-----------------------|----------------------------|---|-------------------------------|---------------------------------|------------------------------|---------------------|--------------------|----------------------------|---|
| L | 3 | L | 1 | 6 | D | 225 | M | A | B | 3 | A |
| Style | IDC Case Size | Low Inductance | Number of Terminals | Voltage | Dielectric | Capacitance Code (In pF) | Capacitance Tolerance | Failure Rate | Termination | Packaging Available | Thickness Max. Thickness |
| | 2 = 0508 3 = 0612 4 = 0306 | | 1 = 8 Terminals | 4 = 4V 6 = 6.3V Z = 10V Y = 16V 3 = 25V | C = X7R D = X5R Z = X7S | 2 Sig. Digits + Number of Zeros | M = ±20% | A = N/A | B = 5% min. Lead | 1=7" Reel 3=13" Reel | mm (in) A=Standard S=0.55 (0.022) |

NOTE: Contact factory for availability of Termination and Tolerance Options for Specific Part Numbers.

***Not RoHS Compliant**

PERFORMANCE CHARACTERISTICS

| | |
|---|--|
| Capacitance Tolerance | ±20% Preferred |
| Operation Temperature Range | X7R = -55°C to +125°C X5R = -55°C to +85°C X7S = -55°C to +125°C |
| Temperature Coefficient | ±15% (0VDC), ±22% (X7S) |
| Voltage Ratings | 4, 6.3, 10, 16, 25 VDC |
| Dissipation Factor | ≤ 6.3V = 6.5% max; 10V = 5.0% max; ≥ 16V = 3.5% max |
| Insulation Resistance (@+25°C, RVDC) | 100,000MΩ min, or 1,000MΩ per μF min., whichever is less |

| | |
|-------------------------------|---|
| Dissipation Factor | No problems observed after 2.5 x RVDC for 5 seconds at 50mA max current |
| CTE (ppm/C) | 12.0 |
| Thermal Conductivity | 4-5W/M K |
| Terminations Available | Plated Nickel and Solder |



The Important Information/Disclaimer is incorporated in the catalog where these specifications came from or available online at www.avx.com/disclaimer/ by reference and should be reviewed in full before placing any order.

IDC Low Inductance Capacitors (SnPb)

IDC (InterDigitated Capacitors) with Sn/Pb Termination 0306/0612/0508



| SIZE | W4 = 0306 | | W2 = Thin 0508 | | | | | W2 = 0508 | | | | | W3= Thin 0612 | | | | W3 = 0612 | | | | | W3 = THICK 0612 | | | |
|----------------|-----------------|-----|-----------------|-----|----|----|----|-----------------|-----|----|----|----|-----------------|-----|----|----|-----------------|-----|----|----|----|-----------------|-----|----|----|
| Max. Thickness | 0.55 (0.022) | | 0.55 (0.022) | | | | | 0.95 (0.037) | | | | | 0.55 (0.022) | | | | 0.95 (0.037) | | | | | 1.22 (0.048) | | | |
| WVDC | 4 | 6.3 | 4 | 6.3 | 10 | 16 | 25 | 4 | 6.3 | 10 | 16 | 25 | 4 | 6.3 | 10 | 16 | 4 | 6.3 | 10 | 16 | 25 | 4 | 6.3 | 10 | 16 |
| Cap (µF) | 0.010 | | | | | | | | | | | | | | | | | | | | | | | | |
| | 0.022 | | | | | | | | | | | | | | | | | | | | | | | | |
| | 0.033 | | | | | | | | | | | | | | | | | | | | | | | | |
| | 0.047 | | | | | | | | | | | | | | | | | | | | | | | | |
| | 0.068 | | | | | | | | | | | | | | | | | | | | | | | | |
| | 0.10 | | | | | | | | | | | | | | | | | | | | | | | | |
| | 0.22 | | | | | | | | | | | | | | | | | | | | | | | | |
| | 0.33 | | | | | | | | | | | | | | | | | | | | | | | | |
| | 0.47 | | | | | | | | | | | | | | | | | | | | | | | | |
| | 0.68 | | | | | | | | | | | | | | | | | | | | | | | | |
| | 1.0 | | | | | | | | | | | | | | | | | | | | | | | | |
| | 1.5 | | | | | | | | | | | | | | | | | | | | | | | | |
| | 2.2 | | | | | | | | | | | | | | | | | | | | | | | | |
| | 3.3 | | | | | | | | | | | | | | | | | | | | | | | | |

PHYSICAL DIMENSIONS AND PAD LAYOUT

Consult factory for additional requirements

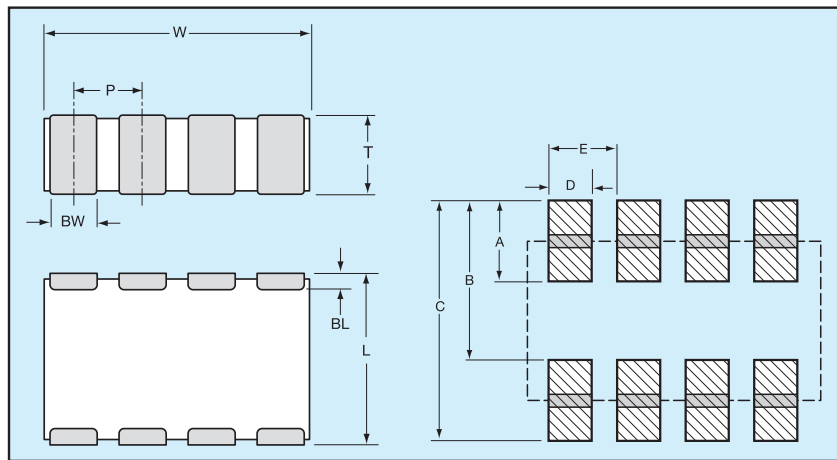

- = X7R
- = X5R
- = X7S

PHYSICAL CHIP DIMENSIONS

MILLIMETERS (INCHES)

| SIZE | W | L | BW | BL | P |
|-------------|--------------------------------|--------------------------------|--------------------------------|--------------------------------|--------------------------------|
| 0306 | 1.60 ± 0.20 (0.063 ± 0.008) | 0.82 ± 0.10 (0.032 ± 0.006) | 0.25 ± 0.10 (0.010 ± 0.004) | 0.20 ± 0.10 (0.008 ± 0.004) | 0.40 ± 0.05 (0.015 ± 0.002) |
| 0508 | 2.03 ± 0.20 (0.080 ± 0.008) | 1.27 ± 0.20 (0.050 ± 0.008) | 0.30 ± 0.10 (0.012 ± 0.004) | 0.25 ± 0.15 (0.010 ± 0.006) | 0.50 ± 0.05 (0.020 ± 0.002) |
| 0612 | 3.20 ± 0.20 (0.126 ± 0.008) | 1.60 ± 0.20 (0.063 ± 0.008) | 0.50 ± 0.10 (0.020 ± 0.004) | 0.25 ± 0.15 (0.010 ± 0.006) | 0.80 ± 0.10 (0.031 ± 0.004) |

PAD LAYOUT DIMENSIONS

| SIZE | A | B | C | D | E |
|-------------|-----------------|-----------------|-----------------|-----------------|-----------------|
| 0306 | 0.38 (0.015) | 0.89 (0.035) | 1.27 (0.050) | 0.20 (0.008) | 0.40 (0.015) |
| 0508 | 0.64 (0.025) | 1.27 (0.050) | 1.91 (0.075) | 0.28 (0.011) | 0.50 (0.020) |
| 0612 | 0.89 (0.035) | 1.65 (0.065) | 2.54 (0.010) | 0.45 (0.018) | 0.80 (0.031) |

LGA Low Inductance Capacitors

0204/0306 Land Grid Array

Land Grid Array (LGA) capacitors are the latest family of low inductance MLCCs from AVX. These new LGA products are the third low inductance family developed by AVX. The innovative LGA technology sets a new standard for low inductance MLCC performance.

Our initial 2 terminal versions of LGA technology deliver the performance of an 8 terminal IDC low inductance MLCC with a number of advantages including:

- Simplified layout of 2 large solder pads compared to 8 small pads for IDCs
- Opportunity to reduce PCB or substrate contribution to system ESL by using multiple parallel vias in solder pads
- Advanced FCT manufacturing process used to create uniformly flat terminations on the capacitor that resist “tombstoning”
- Better solder joint reliability



APPLICATIONS

Semiconductor Packages

- Microprocessors/CPUs
- Graphics Processors/GPUs
- Chipsets
- FPGAs
- ASICs

Board Level Device Decoupling

- Frequencies of 300 MHz or more
- ICs drawing 15W or more
- Low voltages
- High speed buses

0306 2 TERMINAL LGA COMPARISON WITH 0306 8 TERMINAL IDC

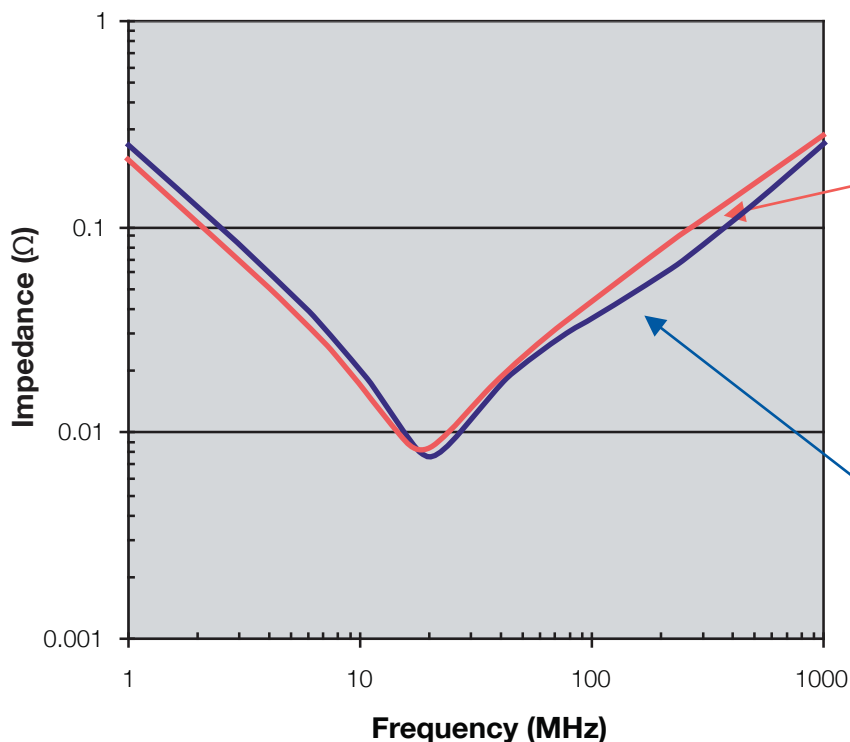

LGA Low Inductance Capacitors

0204/0306 Land Grid Array

| SIZE | LG12 (0204) | | | | | | LG22 (0306) | | | | | | | | | |
|-----------------|--------------|----------|------------|----------|------------|----------|--------------|------------|----------|------------|----------|------------|----------|------------|----------|--|
| Length mm (in.) | 0.50 (0.020) | | | | | | 0.76 (0.030) | | | | | | | | | |
| Width mm (in.) | 1.00 (0.039) | | | | | | 1.60 (0.063) | | | | | | | | | |
| Temp. Char. | X5R (D) | | X7S (Z) | | X6S (W) | | X7R (C) | | X5R (D) | | X7S (Z) | | X6S (W) | | | |
| Working Voltage | 6.3 (6) | 4 (4) | 6.3 (6) | 4 (4) | 6.3 (6) | 4 (4) | 10 (Z) | 6.3 (6) | 4 (4) | 6.3 (6) | 4 (4) | 6.3 (6) | 4 (4) | 6.3 (6) | 4 (4) | |
| Cap (µF) | 0.010 (103) | | | | | | | | | | | | | | | |
| | 0.022 (223) | | | | | | | | | | | | | | | |
| | 0.047 (473) | | | | | | | | | | | | | | | |
| | 0.100 (104) | | | | | | | | | | | | | | | |
| | 0.220 (224) | | | | | | | | | | | | | | | |
| | 0.330 (334) | | | | | | | | | | | | | | | |
| | 0.470 (474) | | | | | | | | | | | | | | | |
| | 1.000 (105) | | | | | | | | | | | | | | | |
| | 2.200 (225) | | | | | | | | | | | | | | | |
| | = X7R | | = X5R | | = X7S | | = X6S | | | | | | | | | |

HOW TO ORDER

| | | | | | | | | | | | |
|-----------|-----------------------------------|--------------------------|--|--|------------|---------------------------|-----------------------------------|--|--|-----------------------------|----------------------|
| LG | 1 | 2 | 6 | Z | 104 | M | A | T | 2 | S | 1 |
| Style | Case Size 1 = 0204 2 = 0306 | Number of Terminals 2 | Working Voltage 4=4V 6=6.3V Z=10V | Temperature Characteristic C = X7R D = X5R Z = X7S W = X6S | Coded Cap | Cap Tolerance M = ±20% | Termination Style A = "U" Land | Termination 100% Sn* *Contact factory for other termination finishes | Packaging Tape & Reel 2 = 7" Reel 4 = 13" Reel | Thickness S = 0.55mm max | Number of Capacitors |

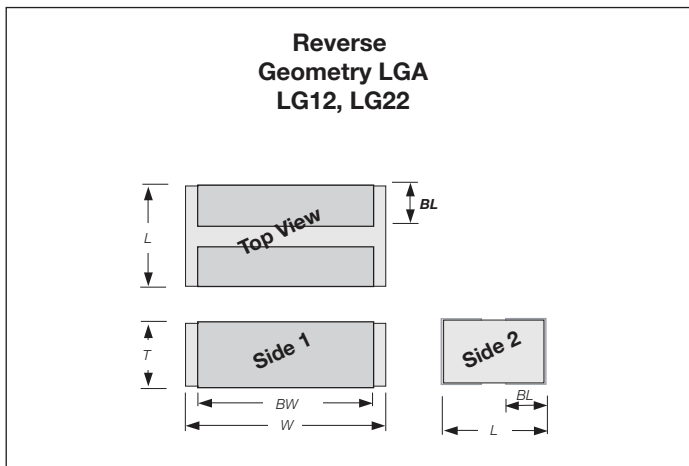

PART DIMENSIONS

MM (INCHES)

| Series | L | W | T | BW | BL |
|-------------|--------------------------------|--------------------------------|--------------------------------|--------------------------------|--------------------------------|
| LG12 (0204) | 0.5 ± 0.05 (0.020 ± 0.002) | 1.00 ± 0.10 (0.039 ± 0.004) | 0.50 ± 0.05 (0.020 ± 0.002) | 0.8 ± 0.10 (0.031 ± 0.004) | 0.13 ± 0.08 (0.005 ± 0.003) |
| LG22 (0306) | 0.76 ± 0.10 (0.030 ± 0.004) | 1.60 ± 0.10 (0.063 ± 0.004) | 0.50 ± 0.05 (0.020 ± 0.002) | 1.50 ± 0.10 (0.059 ± 0.004) | 0.28 ± 0.08 (0.011 ± 0.003) |



RECOMMENDED SOLDER PAD DIMENSIONS

MM (INCHES)

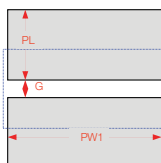

| Series | PL | PW1 | G |
|-------------|--------------|--------------|--------------|
| LG12 (0204) | 0.50 (0.020) | 1.00 (0.039) | 0.20 (0.008) |
| LG22 (0306) | 0.65 (0.026) | 1.50 (0.059) | 0.20 (0.008) |

LGA Low Inductance Capacitors

0204/0306 Land Grid Array – Tin/Lead Termination “B”

| SIZE | PG12 (0204) | | | | | | PG22 (0306) | | | | | | | | | | | |
|-----------------|--------------|----------|-------------|----------|-------------|----------|--------------|------------|-------------|------------|-------------|------------|-------------|------------|-------------|--|-------------|--|
| Length mm (in.) | 0.50 (0.020) | | | | | | 0.76 (0.030) | | | | | | | | | | | |
| Width mm (in.) | 1.00 (0.039) | | | | | | 1.60 (0.063) | | | | | | | | | | | |
| Temp. Char. | X5R (D) | | X7S (Z) | | X6S (W) | | X7R (C) | | X5R (D) | | X7S (Z) | | X6S (W) | | | | | |
| Working Voltage | 6.3 (6) | 4 (4) | 6.3 (6) | 4 (4) | 6.3 (6) | 4 (4) | 10 (Z) | 6.3 (6) | 4 (4) | 6.3 (6) | 4 (4) | 6.3 (6) | 4 (4) | 6.3 (6) | 4 (4) | | | |
| Cap (µF) | 0.010 (103) | | 0.022 (223) | | 0.047 (473) | | 0.100 (104) | | 0.220 (224) | | 0.330 (334) | | 0.470 (474) | | 1.000 (105) | | 2.200 (225) | |

= X7R
 = X5R
 = X7S
 = X6S

HOW TO ORDER

| | | | | | | | | | | | |
|--------------|----------------------|----------------------------|-------------------------|--|------------------|----------------------|--------------------------|--------------------------------|----------------------------------|------------------|-----------------------------|
| PG | 1 | 2 | 6 | Z | 104 | M | A | B | 2 | S | 1 |
| | | | | | | | | | | | |
| Style | Case Size | Number of Terminals | Working Voltage | Temperature Characteristic | Coded Cap | Cap Tolerance | Termination Style | Termination 5% Min Lead | Packaging Tape & Reel | Thickness | Number of Capacitors |
| | 1 = 0204 2 = 0306 | 2 | 4=4V 6=6.3V Z=10V | C = X7R D = X5R Z = X7S W = X6S | | M = ±20% | A = "U" Land | | 2 = 7" Reel 4 = 13" Reel | S = 0.55mm max | |

*Not RoHS Compliant

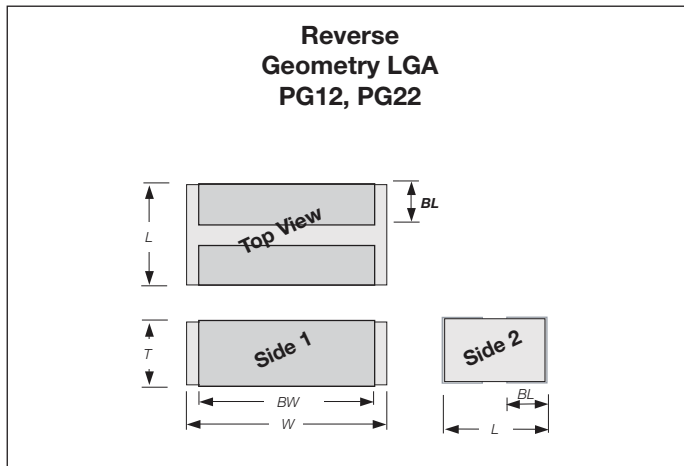

PART DIMENSIONS

MM (INCHES)

| Series | L | W | T | BW | BL |
|--------------------|--------------------------------|--------------------------------|--------------------------------|--------------------------------|--------------------------------|
| PG12 (0204) | 0.5 ± 0.05 (0.020 ± 0.002) | 1.00 ± 0.10 (0.039 ± 0.004) | 0.50 ± 0.05 (0.020 ± 0.002) | 0.8 ± 0.10 (0.031 ± 0.004) | 0.13 ± 0.08 (0.005 ± 0.003) |
| PG22 (0306) | 0.76 ± 0.10 (0.030 ± 0.004) | 1.60 ± 0.10 (0.063 ± 0.004) | 0.50 ± 0.05 (0.020 ± 0.002) | 1.50 ± 0.10 (0.059 ± 0.004) | 0.28 ± 0.08 (0.011 ± 0.003) |

RECOMMENDED SOLDER PAD DIMENSIONS

MM (INCHES)

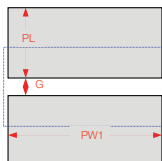

| Series | PL | PW1 | G |
|--------------------|--------------|--------------|--------------|
| PG12 (0204) | 0.50 (0.020) | 1.00 (0.039) | 0.20 (0.008) |
| PG22 (0306) | 0.65 (0.026) | 1.50 (0.059) | 0.20 (0.008) |

High Temperature MLCCs

AT Series – 200°C & 250°C Rated

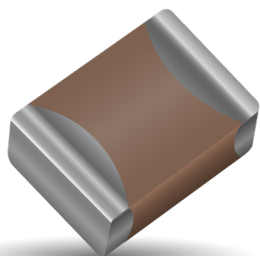

Present military specifications, as well as a majority of commercial applications, require a maximum operating temperature of 125°C. However, the emerging market for high temperature electronics demands capacitors operating reliably at temperatures beyond 125°C. AVX's high temperature chip capacitor product line, has been extended with the BME COG chip. All AT chips have verified capabilities of long term operation up to 250°C for applications in both military and commercial businesses. These capacitors demonstrate high volumetric efficiency, high insulation resistance and low ESR/ESL for the most demanding applications, such as "down-hole" oil exploration and aerospace programs.

HOW TO ORDER

| | | | | | | | | |
|--|-------------------------------|--|--|---------------------------------|-----------------------------------|---|---|-------------------------------------|
| AT10 | 3 | T | 104 | K | A | T | 2 | A |
| AVX Style | Voltage Code | Temperature Coefficient | Capacitance Code (2 significant digits + no. of zeros) | Capacitance Tolerance | Test Level A = Standard | Termination | Packaging | Special Code A = Standard |
| AT03 = 0603 AT05 = 0805 AT06 = 1206 AT10 = 1210 AT12 = 1812 AT14 = 2225 | 16V = Y 25V = 3 50V = 5 | PME COG 250°C = A COG 200°C = 2 VHT 250°C = T VHT 200°C = 4 BME COG 250°C = 5 COG 200°C = 3 | 101 = 100pF 102 = 1nF 103 = 10nF 104 = 100nF 105 = 1µF | J = ±5% K = ±10% M = ±20% | | 1 = Pd/Ag T = 100% Sn Plated (RoHS Compliant) 7 = Ni/Au Plated (For 250°C BME COG Only) | 2 = 7" Reel 4 = 13" Reel 9 = Bulk | |

ELECTRICAL SPECIFICATIONS

Temperature Coefficient

PME COG 0±30ppm/°C, -55C to 250°C

BME COG 0±30ppm/°C, -55C to 200°C

See TCC Plot for +250°C

VHT: T ±15%, -55°C to +150°C

See TCC Plot for +250°C

Capacitance Test (MIL-STD-202, Method 305)

25°C, 1.0 ± 0.2 Vrms (open circuit voltage) @ 1kHz

Dissipation factor 25°C

COG: 0.15% Max at 1.0 ± 0.2 Vrms (open circuit voltage) @ 1kHz

VHT: 2.5% Max at 1.0 ± 0.2 Vrms (open circuit voltage) @ 1kHz

Insulation Resistance 25°C (MIL-STD-202, Method 302)

100GΩ or 1000MΩ-µF (whichever is less)

Insulation Resistance 125°C (MIL-STD-202, Method 302)

10GΩ or 100MΩ-µF (whichever is less)

Insulation Resistance 200°C (MIL-STD-202, Method 302)

1GΩ or 10MΩ-µF (whichever is less)

Insulation Resistance 250°C (MIL-STD-202, Method 302)

100MΩ or 1MΩ-µF (whichever is less)

Direct Withstanding Voltage 25°C (Flash Test)

250% rated voltage for 5 seconds with 50mA max charging current

DIMENSIONS:

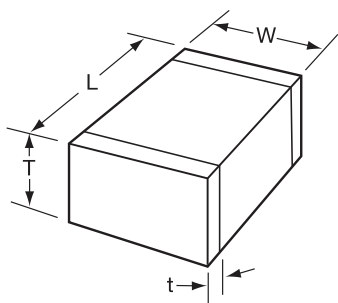

millimeters (inches)

| Size | AT03 = 0603 | AT05 = 0805 | AT06 = 1206 | AT10 = 1210 | AT12 = 1812 | AT14 = 2225 |
|--------------------|--|--------------------------------|--------------------------------|--------------------------------|--------------------------------|--------------------------------|
| (L) Length | 1.60 ± 0.15 (0.063 ± 0.006) | 2.01 ± 0.20 (0.079 ± 0.008) | 3.20 ± 0.20 (0.126 ± 0.008) | 3.20 ± 0.20 (0.126 ± 0.008) | 4.50 ± 0.30 (0.177 ± 0.012) | 5.72 ± 0.25 (0.225 ± 0.010) |
| (W) Width | 0.81 ± 0.15 (0.032 ± 0.006) | 1.25 ± 0.20 (0.049 ± 0.008) | 1.60 ± 0.20 (0.063 ± 0.008) | 2.50 ± 0.20 (0.098 ± 0.008) | 3.20 ± 0.20 (0.126 ± 0.008) | 6.35 ± 0.25 (0.250 ± 0.010) |
| (T) Thickness Max. | 1.02 (0.040) | 1.30 (0.051) | 1.52 (0.060) | 1.70 (0.067) | 2.54 (0.100) | 2.54 (0.100) |
| (t) terminal | min. 0.25 (0.010) max. 0.75 (0.030) | 0.25 (0.010) 0.75 (0.030) | 0.25 (0.010) 0.75 (0.030) | 0.25 (0.010) 0.75 (0.030) | 0.25 (0.010) 1.02 (0.040) | 0.25 (0.010) 1.02 (0.040) |

High Temperature MLCC

AT Series – 200°C & 250°C Rated



PERFORMANCE CHARACTERISTICS

Typical Temperature Coefficient of Capacitance (VHT Dielectric)

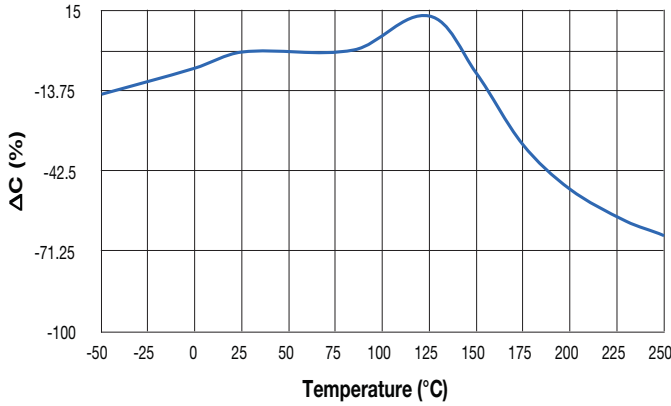

Typical Temperature Coefficient of Capacitance (COG Dielectric)

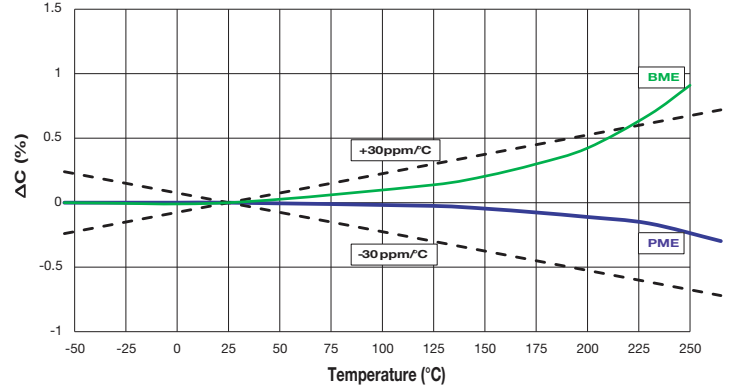

Typical Voltage Coefficient of Capacitance (VHT Dielectric)

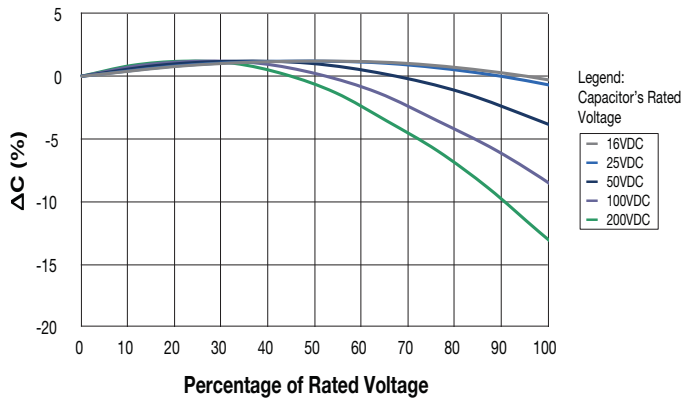

Typical Voltage Coefficient of Capacitance (COG Dielectric)

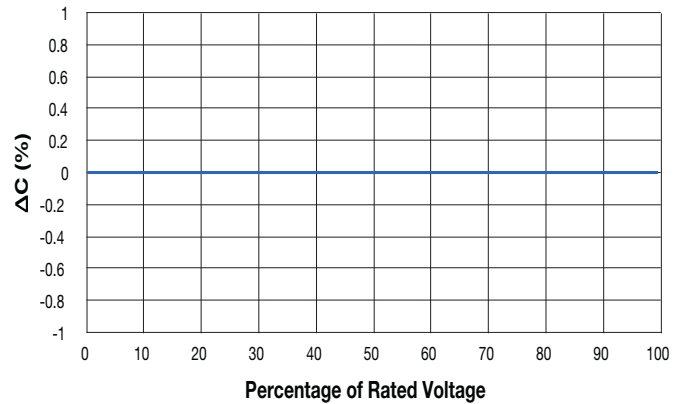

Typical RC vs Temperature (VHT Dielectric)

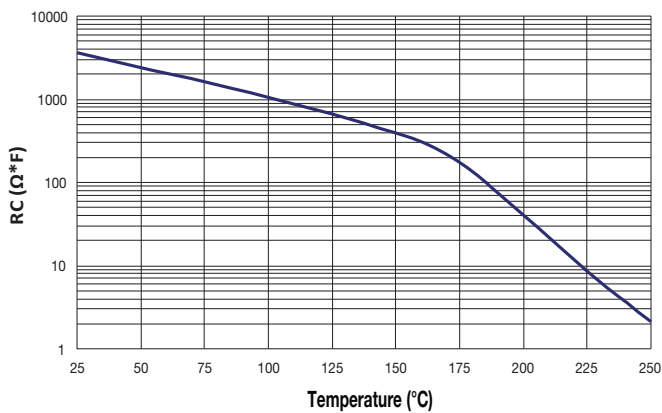

Typical RC vs Temperature (COG Dielectric)

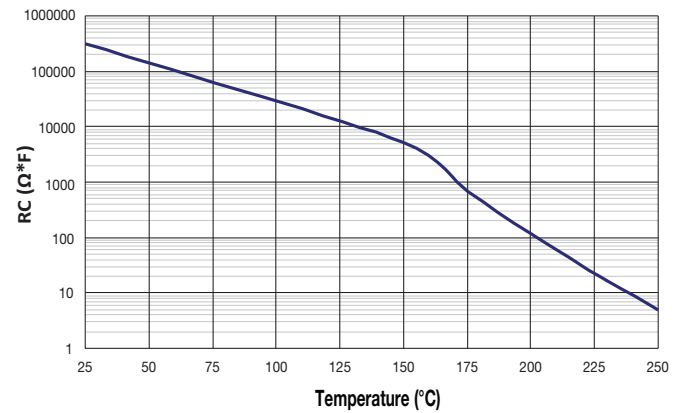

High Temperature MLCC

AT Series – 200°C & 250°C Rated



RELIABILITY

250°C Life Test @ 2x Rated Voltage (VHT Dielectric)

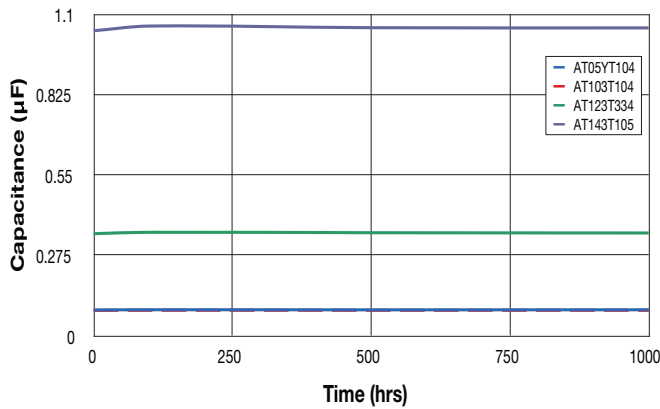

250°C Life Test @ 2x Rated Voltage (COG Dielectric)

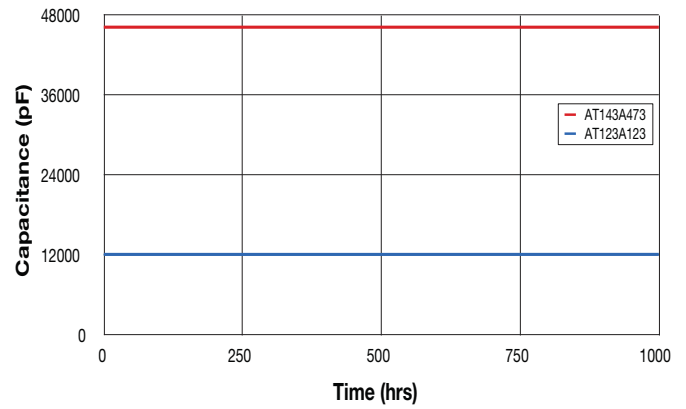

| VHT - Failure Rate @ 90% Confidence Level (%/1000 hours) | | |
|--|-------------------|--------------------|
| Temperature (°C) | 50% Rated Voltage | 100% Rated Voltage |
| 200 | 0.002 | 0.017 |
| 250 | 0.026 | 0.210 |

*Typical 1210, 1812, 2225 Failure Rate Analysis based on 250°C testing and voltage ratings specified on the following page.

| COG - Failure Rate @ 90% Confidence Level (%/1000 hours) | | |
|--|-------------------|--------------------|
| Temperature (°C) | 50% Rated Voltage | 100% Rated Voltage |
| 200 | 0.006 | 0.047 |
| 250 | 0.074 | 0.590 |

*Typical 1812 and 2225 Failure Rate Analysis based on 250°C testing and voltage ratings specified on the following page.

FREQUENCY RESPONSE

Impedance Frequency Response (VHT Dielectric)

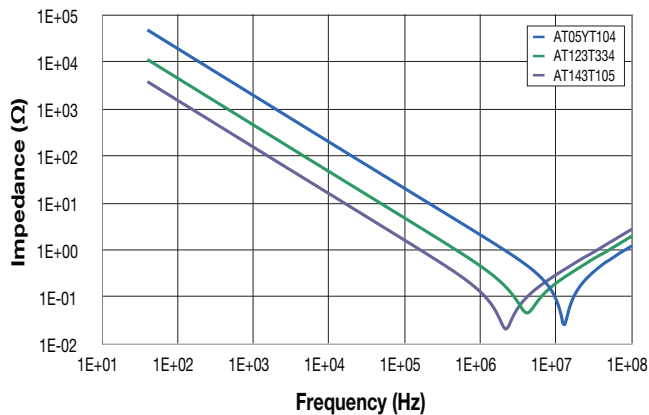

Impedance Frequency Response (COG Dielectric)

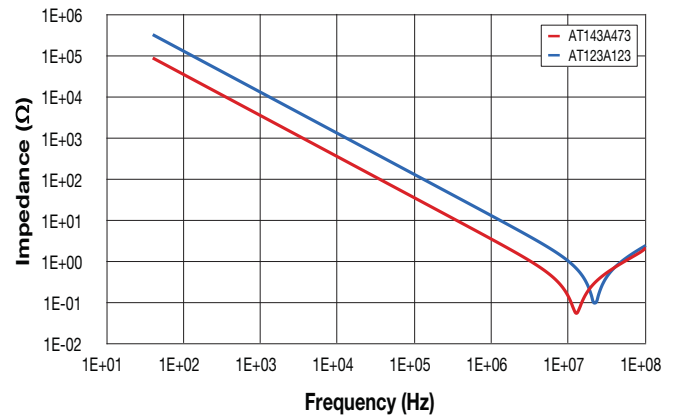

ESR Frequency Response (VHT Dielectric)

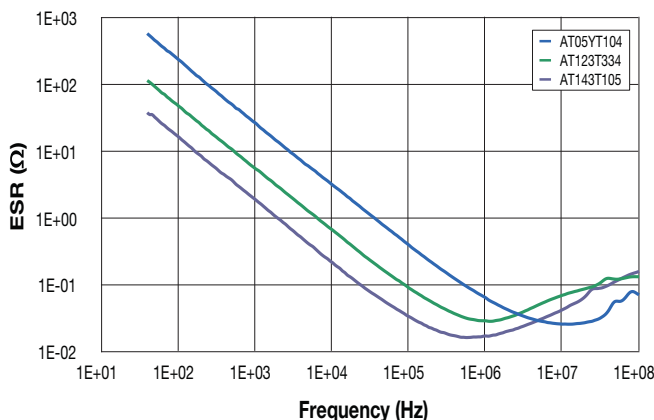

ESR Frequency Response (COG Dielectric)

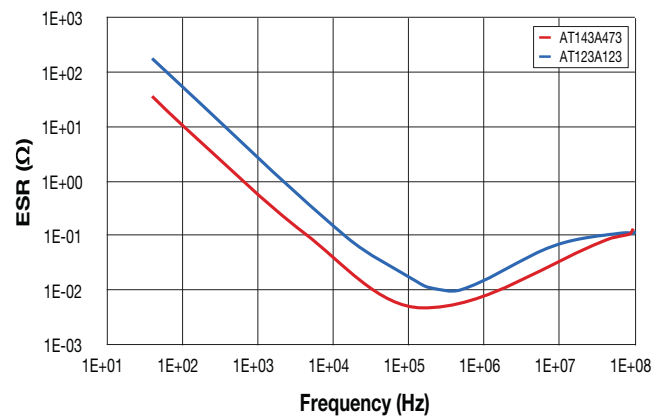

High Temperature MLCC

AT Series – 200°C & 250°C Rated



CAPACITANCE RANGE

PREFERRED SIZES ARE SHADED

VHT Temp. Coefficient: 4 200°C Rated

| Case Size | AT03 = 0603 | AT05 = 0805 | AT06 = 1206 | AT10 = 1210 | AT12 = 1812 | AT14 = 2225 | |
|--------------------------|-------------------------------------|----------------------------|----------------------------|----------------------------|----------------------------|----------------------------|-------------|
| Soldering | Reflow/Wave | Reflow/Wave | Reflow/Wave | Reflow Only | Reflow Only | Reflow Only | |
| (L) Length | mm 1.60±0.15 (in.) (0.063±0.006) | 2.01±0.20 (0.079±0.008) | 3.20±0.20 (0.126±0.008) | 3.20±0.20 (0.126±0.008) | 4.50±0.30 (0.177±0.012) | 5.72±0.25 (0.225±0.010) | |
| (W) Width | mm 0.81±0.15 (in.) (0.032±0.006) | 1.25±0.20 (0.049±0.008) | 1.60±0.20 (0.063±0.008) | 2.50±0.20 (0.098±0.008) | 3.20±0.20 (0.126±0.008) | 6.35±0.25 (0.250±0.010) | |
| (T) Thickness | mm 1.02 (in.) (0.040) | 1.30 (0.051) | 1.52 (0.060) | 1.70 (0.067) | 2.54 (0.100) | 2.54 (0.100) | |
| (t) Terminal | min 0.25(0.010) max 0.75(0.030) | 0.25(0.010) 0.75(0.030) | 0.25(0.010) 0.75(0.030) | 0.25(0.010) 0.75(0.030) | 0.25(0.010) 1.02(0.040) | 0.25(0.010) 1.02(0.040) | |
| Rated Temp. (°C) | 200 | 200 | 200 | 200 | 200 | 200 | |
| Temp. Coefficient | 4 | 4 | 4 | 4 | 4 | 4 | |
| Voltage (V) | 25 | 25 50 | 25 50 | 25 50 | 50 | 50 | |
| Cap (pF) | 1000 102 | | | | | | |
| | 1200 122 | | | | | | |
| | 1500 152 | | | | | | |
| | 1800 182 | | | | | | |
| | 2200 222 | | | | | | |
| | 2700 272 | | | | | | |
| | 3300 332 | | | | | | |
| | 3900 392 | | | | | | |
| | 4700 472 | | | | | | |
| | 5600 562 | | | | | | |
| Cap (µF) | 6800 682 | | | | | | |
| | 8200 822 | | | | | | |
| | 0.010 103 | | | | | | |
| | 0.012 123 | | | | | | |
| | 0.015 153 | | | | | | |
| | 0.018 183 | | | | | | |
| | 0.022 223 | | | | | | |
| | 0.027 273 | | | | | | |
| | 0.033 333 | | | | | | |
| | 0.039 393 | | | | | | |
| Cap (µF) | 0.047 473 | | | | | | |
| | 0.056 563 | | | | | | |
| | 0.068 683 | | | | | | |
| | 0.082 823 | | | | | | |
| | 0.100 104 | | | | | | |
| | 0.120 124 | | | | | | |
| | 0.150 154 | | | | | | |
| | 0.180 184 | | | | | | |
| | 0.220 224 | | | | | | |
| | 0.270 274 | | | | | | |
| Cap (µF) | 0.330 334 | | | | | | |
| | 0.390 394 | | | | | | |
| | 0.470 474 | | | | | | |
| | 0.560 564 | | | | | | |
| | 0.680 684 | | | | | | |
| | 0.820 824 | | | | | | |
| | 1.000 105 | | | | | | |
| | Voltage (V) | 25 | 25 50 | 25 50 | 25 50 | 50 | 50 |
| | Rated Temp. (°C) | 200 | 200 | 200 | 200 | 200 | 200 |
| | Case Size | AT03 = 0603 | AT05 = 0805 | AT06 = 1206 | AT10 = 1210 | AT12 = 1812 | AT14 = 2225 |

VHT Temp. Coefficient: T 250°C Rated

| Case Size | AT03 = 0603 | AT05 = 0805 | AT06 = 1206 | AT10 = 1210 | AT12 = 1812 | AT14 = 2225 | |
|--------------------------|-------------------------------------|----------------------------|----------------------------|----------------------------|----------------------------|----------------------------|-------------|
| Soldering | Reflow/Wave | Reflow/Wave | Reflow/Wave | Reflow Only | Reflow Only | Reflow Only | |
| (L) Length | mm 1.60±0.15 (in.) (0.063±0.006) | 2.01±0.20 (0.079±0.008) | 3.20±0.20 (0.126±0.008) | 3.20±0.20 (0.126±0.008) | 4.50±0.30 (0.177±0.012) | 5.72±0.25 (0.225±0.010) | |
| (W) Width | mm 0.81±0.15 (in.) (0.032±0.006) | 1.25±0.20 (0.049±0.008) | 1.60±0.20 (0.063±0.008) | 2.50±0.20 (0.098±0.008) | 3.20±0.20 (0.126±0.008) | 6.35±0.25 (0.250±0.010) | |
| (T) Thickness | mm 1.02 (in.) (0.040) | 1.30 (0.051) | 1.52 (0.060) | 1.70 (0.067) | 2.54 (0.100) | 2.54 (0.100) | |
| (t) Terminal | min 0.25(0.010) max 0.75(0.030) | 0.25(0.010) 0.75(0.030) | 0.25(0.010) 0.75(0.030) | 0.25(0.010) 0.75(0.030) | 0.25(0.010) 1.02(0.040) | 0.25(0.010) 1.02(0.040) | |
| Rated Temp. (°C) | 250 | 250 | 250 | 250 | 250 | 250 | |
| Temp. Coefficient | T | T | T | T | T | T | |
| Voltage (V) | 16 | 16 25 | 16 25 | 16 25 | 25 | 25 | |
| Cap (pF) | 1000 102 | | | | | | |
| | 1200 122 | | | | | | |
| | 1500 152 | | | | | | |
| | 1800 182 | | | | | | |
| | 2200 222 | | | | | | |
| | 2700 272 | | | | | | |
| | 3300 332 | | | | | | |
| | 3900 392 | | | | | | |
| | 4700 472 | | | | | | |
| | 5600 562 | | | | | | |
| Cap (µF) | 6800 682 | | | | | | |
| | 8200 822 | | | | | | |
| | 0.010 103 | | | | | | |
| | 0.012 123 | | | | | | |
| | 0.015 153 | | | | | | |
| | 0.018 183 | | | | | | |
| | 0.022 223 | | | | | | |
| | 0.027 273 | | | | | | |
| | 0.033 333 | | | | | | |
| | 0.039 393 | | | | | | |
| Cap (µF) | 0.047 473 | | | | | | |
| | 0.056 563 | | | | | | |
| | 0.068 683 | | | | | | |
| | 0.082 823 | | | | | | |
| | 0.100 104 | | | | | | |
| | 0.120 124 | | | | | | |
| | 0.150 154 | | | | | | |
| | 0.180 184 | | | | | | |
| | 0.220 224 | | | | | | |
| | 0.270 274 | | | | | | |
| Cap (µF) | 0.330 334 | | | | | | |
| | 0.390 394 | | | | | | |
| | 0.470 474 | | | | | | |
| | 0.560 564 | | | | | | |
| | 0.680 684 | | | | | | |
| | 0.820 824 | | | | | | |
| | 1.000 105 | | | | | | |
| | Voltage (V) | 16 | 16 25 | 16 25 | 16 25 | 25 | 25 |
| | Rated Temp. (°C) | 250 | 250 | 250 | 250 | 250 | 250 |
| | Case Size | AT03 = 0603 | AT05 = 0805 | AT06 = 1206 | AT10 = 1210 | AT12 = 1812 | AT14 = 2225 |

Voltage rating per table. Capacitance values specified at 25°C, derate capacitance value based on TCC and VCC Plots on page 107.

NOTE: Contact factory for non-specified capacitance values.



The Important Information/Disclaimer is incorporated in the catalog where these specifications came from or available online at www.avx.com/disclaimer/ by reference and should be reviewed in full before placing any order.

High Temperature MLCC

AT Series – 200°C & 250°C Rated



CAPACITANCE RANGE

PREFERRED SIZES ARE SHADED

BME COG Temp. Coefficient: 4 200°C Rated

| Case Size | | AT03=0603 | | AT05=0805 | | AT06=1206 | |
|-------------------|-------|---------------|-----|---------------|-----|---------------|-----|
| Soldering | | Reflow/Wave | | Reflow/Wave | | Reflow/Wave | |
| (L) Length | mm | 1.60±0.15 | | 2.01±0.20 | | 3.20±0.20 | |
| | (in.) | (0.063±0.006) | | (0.079±0.008) | | (0.126±0.008) | |
| (W) Width | mm | 0.81±0.15 | | 1.25±0.20 | | 1.60±0.20 | |
| | (in.) | (0.032±0.006) | | (0.049±0.008) | | (0.063±0.008) | |
| (T) Thickness | mm | 1.02 | | 1.30 | | 1.52 | |
| | (in.) | (0.040) | | (0.051) | | (0.060) | |
| (t) Terminal | min | 0.25(0.010) | | 0.25(0.010) | | 0.25(0.010) | |
| | max | 0.75(0.030) | | 0.75(0.030) | | 0.75(0.030) | |
| Rated Temp. (°C) | | 200 | | 200 | | 200 | |
| Temp. Coefficient | | 3 | | 3 | | 3 | |
| Voltage (V) | | 25 | 50 | 25 | 50 | 25 | 50 |
| Cap (pF) | 39 | 390 | | | | | |
| | 47 | 470 | | | | | |
| Cap (pF) | 56 | 560 | | | | | |
| | 68 | 680 | | | | | |
| Cap (pF) | 82 | 820 | | | | | |
| | 100 | 101 | | | | | |
| Cap (pF) | 120 | 121 | | | | | |
| | 150 | 151 | | | | | |
| Cap (pF) | 180 | 181 | | | | | |
| | 220 | 221 | | | | | |
| Cap (pF) | 270 | 271 | | | | | |
| | 330 | 331 | | | | | |
| Cap (pF) | 390 | 391 | | | | | |
| | 470 | 471 | | | | | |
| Cap (pF) | 560 | 561 | | | | | |
| | 680 | 681 | | | | | |
| Cap (pF) | 820 | 821 | | | | | |
| | 1000 | 102 | | | | | |
| Cap (pF) | 1200 | 122 | | | | | |
| | 1500 | 152 | | | | | |
| Cap (pF) | 1800 | 182 | | | | | |
| | 2200 | 222 | | | | | |
| Cap (pF) | 2700 | 272 | | | | | |
| | 3300 | 332 | | | | | |
| Cap (pF) | 3900 | 392 | | | | | |
| | 4700 | 472 | | | | | |
| Cap (pF) | 5600 | 562 | | | | | |
| | 6800 | 682 | | | | | |
| Cap (pF) | 8200 | 822 | | | | | |
| | 0.010 | 103 | | | | | |
| Cap (pF) | 0.012 | 123 | | | | | |
| | 0.015 | 153 | | | | | |
| Cap (pF) | 0.018 | 183 | | | | | |
| | 0.022 | 223 | | | | | |
| Cap (pF) | 0.027 | 273 | | | | | |
| | 0.033 | 333 | | | | | |
| Cap (pF) | 0.039 | 393 | | | | | |
| | 0.047 | 473 | | | | | |
| Cap (pF) | 0.056 | 563 | | | | | |
| | 0.068 | 683 | | | | | |
| Cap (pF) | 0.082 | 823 | | | | | |
| | 0.100 | 104 | | | | | |
| Voltage (V) | | 25 | 50 | 25 | 50 | 25 | 50 |
| Rated Temp. (°C) | | 200 | 200 | 200 | 200 | 200 | 200 |
| Case Size | | AT03=0603 | | AT05=0805 | | AT06=1206 | |

BME COG (Ni/Au) Temp. Coefficient: 5 250°C Rated

| Case Size | | AT03=0603 | | AT05=0805 | | AT06 = 1206 | |
|-------------------|-------|---------------|--|---------------|--|---------------|--|
| Soldering | | Reflow/Wave | | Reflow/Wave | | Reflow/Wave | |
| (L) Length | mm | 1.60±0.15 | | 2.01±0.20 | | 3.20±0.20 | |
| | (in.) | (0.063±0.006) | | (0.079±0.008) | | (0.126±0.008) | |
| (W) Width | mm | 0.81±0.15 | | 1.25±0.20 | | 1.60±0.20 | |
| | (in.) | (0.032±0.006) | | (0.049±0.008) | | (0.063±0.008) | |
| (T) Thickness | mm | 1.02 | | 1.30 | | 1.52 | |
| | (in.) | (0.040) | | (0.051) | | (0.060) | |
| (t) Terminal | min | 0.25(0.010) | | 0.25(0.010) | | 0.25(0.010) | |
| | max | 0.75(0.030) | | 0.75(0.030) | | 0.75(0.030) | |
| Rated Temp. (°C) | | 250 | | 250 | | 250 | |
| Temp. Coefficient | | 5 | | 5 | | 5 | |
| Voltage (V) | | 25 | | 25 | | 25 | |
| Cap (pF) | 39 | 390 | | | | | |
| | 47 | 470 | | | | | |
| Cap (pF) | 56 | 560 | | | | | |
| | 68 | 680 | | | | | |
| Cap (pF) | 82 | 820 | | | | | |
| | 100 | 101 | | | | | |
| Cap (pF) | 120 | 121 | | | | | |
| | 150 | 151 | | | | | |
| Cap (pF) | 180 | 181 | | | | | |
| | 220 | 221 | | | | | |
| Cap (pF) | 270 | 271 | | | | | |
| | 330 | 331 | | | | | |
| Cap (pF) | 390 | 391 | | | | | |
| | 470 | 471 | | | | | |
| Cap (pF) | 560 | 561 | | | | | |
| | 680 | 681 | | | | | |
| Cap (pF) | 820 | 821 | | | | | |
| | 1000 | 102 | | | | | |
| Cap (pF) | 1200 | 122 | | | | | |
| | 1500 | 152 | | | | | |
| Cap (pF) | 1800 | 182 | | | | | |
| | 2200 | 222 | | | | | |
| Cap (pF) | 2700 | 272 | | | | | |
| | 3300 | 332 | | | | | |
| Cap (pF) | 3900 | 392 | | | | | |
| | 4700 | 472 | | | | | |
| Cap (pF) | 5600 | 562 | | | | | |
| | 6800 | 682 | | | | | |
| Cap (pF) | 8200 | 822 | | | | | |
| | 0.010 | 103 | | | | | |
| Cap (pF) | 0.012 | 123 | | | | | |
| | 0.015 | 153 | | | | | |
| Cap (pF) | 0.018 | 183 | | | | | |
| | 0.022 | 223 | | | | | |
| Cap (pF) | 0.027 | 273 | | | | | |
| | 0.033 | 333 | | | | | |
| Cap (pF) | 0.039 | 393 | | | | | |
| | 0.047 | 473 | | | | | |
| Cap (pF) | 0.056 | 563 | | | | | |
| | 0.068 | 683 | | | | | |
| Cap (pF) | 0.082 | 823 | | | | | |
| | 0.100 | 104 | | | | | |
| Voltage (V) | | 25 | | 25 | | 25 | |
| Rated Temp. (°C) | | 250 | | 250 | | 250 | |
| Case Size | | AT03=0603 | | AT05=0805 | | AT06=1206 | |

Voltage rating per table. Capacitance values specified at 25°C, derate capacitance value based on TCC and VCC Plots on page 107.

NOTE: Contact factory for non-specified capacitance values.

High Temperature MLCC

AT Series – 200°C & 250°C Rated



CAPACITANCE RANGE

PREFERRED SIZES ARE SHADED

PME COG Temp. Coefficient: 2 200°C Rated

| Case Size | AT05 = 0805 | AT06 = 1206 | AT10 = 1210 | AT12 = 1812 | AT14 = 2225 |
|--------------------------|---|--------------------------------|--------------------------------|--------------------------------|--------------------------------|
| Soldering | Reflow/Wave | Reflow/Wave | Reflow Only | Reflow Only | Reflow Only |
| (L) Length | mm 2.01 ± 0.20 (in.) (0.079 ± 0.008) | 3.20 ± 0.20 (0.126 ± 0.008) | 3.20 ± 0.20 (0.126 ± 0.008) | 4.50 ± 0.30 (0.177 ± 0.012) | 2.75 ± 0.25 (0.225 ± 0.010) |
| (W) Width | mm 1.25 ± 0.20 (in.) (0.049 ± 0.008) | 1.60 ± 0.20 (0.063 ± 0.008) | 2.50 ± 0.20 (0.098 ± 0.008) | 3.20 ± 0.20 (0.126 ± 0.008) | 6.35 ± 0.25 (0.250 ± 0.010) |
| (T) Thickness | mm 1.30 (in.) (0.051) | 1.52 (0.060) | 1.70 (0.067) | 2.54 (0.100) | 2.54 (0.100) |
| (t) Terminal | min 0.25 (0.010) max 0.75 (0.030) | 0.25 (0.010) 0.75 (0.030) | 0.25 (0.010) 0.75 (0.030) | 0.25 (0.010) 1.02 (0.040) | 0.25 (0.010) 1.02 (0.040) |
| Rated Temp. (°C) | 200 | 200 | 200 | 200 | 200 |
| Temp. Coefficient | 2 | 2 | 2 | 2 | 2 |
| Voltage (V) | 50 | 50 | 50 | 50 | 50 |
| Cap (pF) | 100 101 | | | | |
| | 120 121 | | | | |
| | 150 151 | | | | |
| | 180 181 | | | | |
| | 220 221 | | | | |
| | 270 271 | | | | |
| | 330 331 | | | | |
| | 390 391 | | | | |
| | 470 471 | | | | |
| | 560 561 | | | | |
| | 680 681 | | | | |
| | 820 821 | | | | |
| | 1000 102 | | | | |
| | 1200 122 | | | | |
| | 1500 152 | | | | |
| 1800 182 | | | | | |
| 2200 222 | | | | | |
| 2700 272 | | | | | |
| 3300 332 | | | | | |
| 3900 392 | | | | | |
| 4700 472 | | | | | |
| 5600 562 | | | | | |
| 6800 682 | | | | | |
| 8200 822 | | | | | |
| Cap (µF) | 0.010 103 | | | | |
| | 0.012 123 | | | | |
| | 0.015 153 | | | | |
| | 0.018 183 | | | | |
| | 0.022 223 | | | | |
| | 0.027 273 | | | | |
| | 0.033 333 | | | | |
| | 0.039 393 | | | | |
| | 0.047 473 | | | | |
| | 0.056 563 | | | | |
| 0.068 683 | | | | | |
| 0.082 823 | | | | | |
| 0.100 104 | | | | | |
| Voltage (V) | 50 | 50 | 50 | 50 | 50 |
| Rated Temp. (°C) | 200 | 200 | 200 | 200 | 200 |
| Case Size | AT05 = 0805 | AT06 = 1206 | AT10 = 1210 | AT12 = 1812 | AT14 = 2225 |

PME COG Temp. Coefficient: A 250°C Rated

| Case Size | AT05 = 0805 | AT06 = 1206 | AT10 = 1210 | AT12 = 1812 | AT14 = 2225 |
|--------------------------|---|--------------------------------|--------------------------------|--------------------------------|--------------------------------|
| Soldering | Reflow/Wave | Reflow/Wave | Reflow Only | Reflow Only | Reflow Only |
| (L) Length | mm 2.01 ± 0.20 (in.) (0.079 ± 0.008) | 3.20 ± 0.20 (0.126 ± 0.008) | 3.20 ± 0.20 (0.126 ± 0.008) | 4.50 ± 0.30 (0.177 ± 0.012) | 2.75 ± 0.25 (0.225 ± 0.010) |
| (W) Width | mm 1.25 ± 0.20 (in.) (0.049 ± 0.008) | 1.60 ± 0.20 (0.063 ± 0.008) | 2.50 ± 0.20 (0.098 ± 0.008) | 3.20 ± 0.20 (0.126 ± 0.008) | 6.35 ± 0.25 (0.250 ± 0.010) |
| (T) Thickness | mm 1.30 (in.) (0.051) | 1.52 (0.060) | 1.70 (0.067) | 2.54 (0.100) | 2.54 (0.100) |
| (t) Terminal | min 0.25 (0.010) max 0.75 (0.030) | 0.25 (0.010) 0.75 (0.030) | 0.25 (0.010) 0.75 (0.030) | 0.25 (0.010) 1.02 (0.040) | 0.25 (0.010) 1.02 (0.040) |
| Rated Temp. (°C) | 250 | 250 | 250 | 250 | 250 |
| Temp. Coefficient | A | A | A | A | A |
| Voltage (V) | 25 | 25 | 25 | 25 | 25 |
| Cap (pF) | 100 101 | | | | |
| | 120 121 | | | | |
| | 150 151 | | | | |
| | 180 181 | | | | |
| | 220 221 | | | | |
| | 270 271 | | | | |
| | 330 331 | | | | |
| | 390 391 | | | | |
| | 470 471 | | | | |
| | 560 561 | | | | |
| | 680 681 | | | | |
| | 820 821 | | | | |
| | 1000 102 | | | | |
| | 1200 122 | | | | |
| | 1500 152 | | | | |
| 1800 182 | | | | | |
| 2200 222 | | | | | |
| 2700 272 | | | | | |
| 3300 332 | | | | | |
| 3900 392 | | | | | |
| 4700 472 | | | | | |
| 5600 562 | | | | | |
| 6800 682 | | | | | |
| 8200 822 | | | | | |
| Cap (µF) | 0.010 103 | | | | |
| | 0.012 123 | | | | |
| | 0.015 153 | | | | |
| | 0.018 183 | | | | |
| | 0.022 223 | | | | |
| | 0.027 273 | | | | |
| | 0.033 333 | | | | |
| | 0.039 393 | | | | |
| | 0.047 473 | | | | |
| | 0.056 563 | | | | |
| 0.068 683 | | | | | |
| 0.082 823 | | | | | |
| 0.100 104 | | | | | |
| Voltage (V) | 25 | 25 | 25 | 25 | 25 |
| Rated Temp. (°C) | 250 | 250 | 250 | 250 | 250 |
| Case Size | AT05 = 0805 | AT06 = 1206 | AT10 = 1210 | AT12 = 1812 | AT14 = 2225 |

Voltage rating per table. Capacitance values specified at 25°C, derate capacitance value based on TCC and VCC Plots on page 107.

NOTE: Contact factory for non-specified capacitance values.

High Voltage MLC Chips

For 600V to 5000V Applications

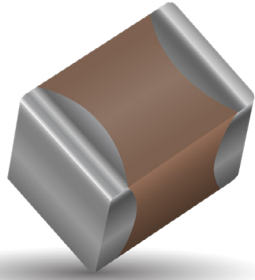

High value, low leakage and small size are difficult parameters to obtain in capacitors for high voltage systems. AVX special high voltage MLC chip capacitors meet these performance characteristics and are designed for applications such as snubbers in high frequency power converters, resonators in SMPS, and high voltage coupling/dc blocking. These high voltage chip designs exhibit low ESRs at high frequencies.

Larger physical sizes than normally encountered chips are used to make high voltage MLC chip products. Special precautions must be taken in applying these chips in surface mount assemblies. The temperature gradient during heating or cooling cycles should not exceed 4°C per second. The preheat temperature must be within 50°C of the peak temperature reached by the ceramic bodies through the soldering process. Chip sizes 1210 and larger should be reflow soldered only. Capacitors may require protective surface coating to prevent external arcing.

For 1825, 2225 and 3640 sizes, AVX offers leaded version in either thru-hole or SMT configurations (for details see section on high voltage leaded MLC chips)

NEW 630V RANGE

HOW TO ORDER

| 1808 | A | A | 271 | M | A | 1 | 2 | A |
|--|--|--------------------------------|---|---|-------------------|--|---|---------------------|
| AVX Style | Voltage | Temperature Coefficient | Capacitance Code (2 significant digits + no. of zeros) | Capacitance Tolerance | Test Level | Termination* | Packaging | Special Code |
| 0805 1206 1210 1808 1812 1825 2220 3640 | 600V/630V = C 1000V = A 1500V = S 2000V = G 2500V = W 3000V = H 4000V = J 5000V = K | NPO (COG) = A X7R = C | Examples: 10 pF = 100 100 pF = 101 1,000 pF = 102 22,000 pF = 223 220,000 pF = 224 1 μF = 105 | COG: J = ±5% K = ±10% M = ±20% X7R: K = ±10% M = ±20% Z = +80%, -20% | A = Standard | 1 = Pd/Ag T = Plated Ni and Sn (RoHS Compliant) | 1 or 2 = 7" Reel** 3 or 4 = 13" Reel | A = Standard |

Notes:

- Capacitors with X7R dielectrics are not intended for applications across AC supply mains or AC line filtering with polarity reversal. Contact plant for recommendations. Contact factory for availability of Termination and Tolerance options for Specific Part Numbers.
- *Terminations with 5% minimum lead (Pb) is available, see pages 100 and 101 for LD style. Leaded terminations are available, see pages 102-106.

**The 3640 Style is not available on 7" Reels.

*** AVX offers nonstandard chip sizes. Contact factory for details.

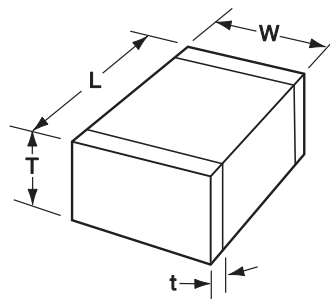

DIMENSIONS

millimeters (inches)

| SIZE | 0805 | 1206 | 1210* | 1808* | 1812* | 1825* | 2220* | 2225* | 3640* |
|------------------------|--------------------------------|--------------------------------|--------------------------------|--------------------------------|--------------------------------|--------------------------------|--------------------------------|--------------------------------|--------------------------------|
| (L) Length | 2.10 ± 0.20 (0.083 ± 0.008) | 3.30 ± 0.30 (0.130 ± 0.012) | 3.30 ± 0.40 (0.130 ± 0.016) | 4.60 ± 0.50 (0.181 ± 0.020) | 4.60 ± 0.50 (0.181 ± 0.020) | 4.60 ± 0.50 (0.181 ± 0.020) | 5.70 ± 0.50 (0.224 ± 0.020) | 5.72 ± 0.25 (0.225 ± 0.010) | 9.14 ± 0.25 (0.360 ± 0.010) |
| (W) Width | 1.25 ± 0.20 (0.049 ± 0.008) | 1.60 ± 0.20 (0.063 ± 0.008) | 2.50 ± 0.30 (0.098 ± 0.012) | 2.00 ± 0.20 (0.079 ± 0.008) | 3.20 ± 0.30 (0.126 ± 0.012) | 6.30 ± 0.40 (0.248 ± 0.016) | 5.00 ± 0.40 (0.197 ± 0.016) | 6.35 ± 0.25 (0.250 ± 0.010) | 10.2 ± 0.25 (0.400 ± 0.010) |
| (T) Thickness Max. | 1.35 (0.053) | 1.80 (0.071) | 2.80 (0.110) | 2.20 (0.087) | 2.80 (0.110) | 3.40 (0.134) | 3.40 (0.134) | 2.54 (0.100) | 2.54 (0.100) |
| (t) terminal min. max. | 0.50 ± 0.20 (0.020 ± 0.008) | 0.60 ± 0.20 (0.024 ± 0.008) | 0.75 ± 0.35 (0.030 ± 0.014) | 0.75 ± 0.35 (0.030 ± 0.014) | 0.75 ± 0.35 (0.030 ± 0.014) | 0.75 ± 0.35 (0.030 ± 0.014) | 0.85 ± 0.35 (0.033 ± 0.014) | 0.85 ± 0.35 (0.033 ± 0.014) | 0.76 (0.030) 1.52 (0.060) |

*Reflow Soldering Only

High Voltage MLC Chips

For 600V to 5000V Applications



NP0 (C0G) CAPACITANCE RANGE – PREFERRED SIZES ARE SHADED

| Case Size | 1825 | | | | | | | | 2220 | | | | | | | | 2225 | | | | | | | | 3640 | | | | | | | | | | |
|------------------|-----------------|-------|------|------|------|------|------|------|-----------------|-------|------|------|------|------|------|------|-----------------|-------|-------|------|------|------|------|------|--------------|------|-------|-------|------|------|------|------|------|------|------|
| | Reflow Only | | | | | | | | Reflow Only | | | | | | | | Reflow Only | | | | | | | | Reflow Only | | | | | | | | | | |
| (L) Length | 4.60 ± 0.50 | | | | | | | | 5.70 ± 0.50 | | | | | | | | 5.70 ± 0.50 | | | | | | | | 9.14 ± 0.25 | | | | | | | | | | |
| (W) Width | 6.30 ± 0.40 | | | | | | | | 5.00 ± 0.40 | | | | | | | | 6.30 ± 0.40 | | | | | | | | 10.2 ± 0.25 | | | | | | | | | | |
| (T) Thickness | 3.40 | | | | | | | | 3.40 | | | | | | | | 3.40 | | | | | | | | 2.54 | | | | | | | | | | |
| (t) Terminal | 0.75 ± 0.35 | | | | | | | | 0.85 ± 0.35 | | | | | | | | 0.85 ± 0.35 | | | | | | | | 0.76 ± 0.030 | | | | | | | | | | |
| (t) Terminal max | (0.030 ± 0.014) | | | | | | | | (0.033 ± 0.014) | | | | | | | | (0.033 ± 0.014) | | | | | | | | 1.52 (0.060) | | | | | | | | | | |
| Voltage (V) | 600 | 630 | 1000 | 1500 | 2000 | 2500 | 3000 | 4000 | 600 | 630 | 1000 | 1500 | 2000 | 2500 | 3000 | 4000 | 5000 | 600 | 630 | 1000 | 1500 | 2000 | 2500 | 3000 | 4000 | 5000 | 600 | 630 | 1000 | 1500 | 2000 | 2500 | 3000 | 4000 | 5000 |
| Cap (pF) | 1.5 | 1R5 | | | | | | | 1.8 | 1R8 | | | | | | | | 2.2 | 2R2 | | | | | | | | 2.7 | 2R7 | | | | | | | |
| Cap (pF) | 3.3 | 3R3 | | | | | | | 3.9 | 3R9 | | | | | | | | 4.7 | 4R7 | | | | | | | | 5.6 | 5R6 | | | | | | | |
| Cap (pF) | 6.8 | 6R8 | | | | | | | 8.2 | 8R2 | | | | | | | | 10 | 10 | | | | | | | | 12 | 12 | | | | | | | |
| Cap (pF) | 15 | 15 | | | | | | | 18 | 18 | | | | | | | | 22 | 22 | | | | | | | | 27 | 27 | | | | | | | |
| Cap (pF) | 33 | 33 | | | | | | | 39 | 39 | | | | | | | | 47 | 47 | | | | | | | | 56 | 56 | | | | | | | |
| Cap (pF) | 68 | 68 | | | | | | | 82 | 82 | | | | | | | | 100 | 100 | | | | | | | | 120 | 120 | | | | | | | |
| Cap (pF) | 150 | 150 | | | | | | | 180 | 180 | | | | | | | | 220 | 220 | | | | | | | | 270 | 270 | | | | | | | |
| Cap (pF) | 330 | 330 | | | | | | | 390 | 390 | | | | | | | | 470 | 470 | | | | | | | | 560 | 560 | | | | | | | |
| Cap (pF) | 680 | 680 | | | | | | | 820 | 820 | | | | | | | | 101 | 101 | | | | | | | | 121 | 121 | | | | | | | |
| Cap (pF) | 151 | 151 | | | | | | | 181 | 181 | | | | | | | | 221 | 221 | | | | | | | | 271 | 271 | | | | | | | |
| Cap (pF) | 331 | 331 | | | | | | | 391 | 391 | | | | | | | | 471 | 471 | | | | | | | | 561 | 561 | | | | | | | |
| Cap (pF) | 681 | 681 | | | | | | | 75 | 75 | | | | | | | | 821 | 821 | | | | | | | | 1002 | 1002 | | | | | | | |
| Cap (pF) | 1200 | 1200 | | | | | | | 1500 | 1500 | | | | | | | | 1800 | 1800 | | | | | | | | 2200 | 2200 | | | | | | | |
| Cap (pF) | 2700 | 2700 | | | | | | | 3300 | 3300 | | | | | | | | 3900 | 3900 | | | | | | | | 4700 | 4700 | | | | | | | |
| Cap (pF) | 5600 | 5600 | | | | | | | 6800 | 6800 | | | | | | | | 8200 | 8200 | | | | | | | | 0.010 | 0.010 | | | | | | | |
| Cap (pF) | 0.012 | 0.012 | | | | | | | 0.015 | 0.015 | | | | | | | | 0.018 | 0.018 | | | | | | | | 0.022 | 0.022 | | | | | | | |
| Cap (pF) | 0.027 | 0.027 | | | | | | | 0.033 | 0.033 | | | | | | | | 0.039 | 0.039 | | | | | | | | 0.047 | 0.047 | | | | | | | |
| Cap (pF) | 0.056 | 0.056 | | | | | | | 0.068 | 0.068 | | | | | | | | 0.100 | 0.100 | | | | | | | | 0.104 | 0.104 | | | | | | | |
| Voltage (V) | 600 | 630 | 1000 | 1500 | 2000 | 2500 | 3000 | 4000 | 600 | 630 | 1000 | 1500 | 2000 | 2500 | 3000 | 4000 | 5000 | 600 | 630 | 1000 | 1500 | 2000 | 2500 | 3000 | 4000 | 5000 | 600 | 630 | 1000 | 1500 | 2000 | 2500 | 3000 | 4000 | 5000 |
| Case Size | 1825 | | | | | | | | 2220 | | | | | | | | 2225 | | | | | | | | 3640 | | | | | | | | | | |

| Letter | A | C | E | F | G | X | 7 |
|----------------|------------------|------------------|-------------------|-------------------|------------------|------------------|-----------------|
| Max. Thickness | 0.813 (0.032) | 1.448 (0.057) | 1.8034 (0.071) | 2.2098 (0.087) | 2.794 (0.110) | 0.940 (0.037) | 3.30 (0.130) |

NOTE: Contact factory for non-specified capacitance values



High Voltage MLC Chips

For 600V to 5000V Applications



X7R Dielectric

Performance Characteristics

| | |
|--|--|
| Capacitance Range | 10 pF to 0.82 μF (25°C, 1.0 ±0.2 Vrms at 1kHz) |
| Capacitance Tolerances | ±10%; ±20%; +80%, -20% |
| Dissipation Factor | 2.5% max. (+25°C, 1.0 ±0.2 Vrms, 1kHz) |
| Operating Temperature Range | -55°C to +125°C |
| Temperature Characteristic | ±15% (0 VDC) |
| Voltage Ratings | 600, 630, 1000, 1500, 2000, 2500, 3000, 4000 & 5000 VDC (+125°C) |
| Insulation Resistance (+25°C, at 500 VDC) | 100K MΩ min. or 1000 MΩ - μF min., whichever is less |
| Insulation Resistance (+125°C, at 500 VDC) | 10K MΩ min. or 100 MΩ - μF min., whichever is less |
| Dielectric Strength | Minimum 120% rated voltage for 5 seconds at 50 mA max. current |

X7R CAPACITANCE RANGE – PREFERRED SIZES ARE SHADED

| Case Size | 0805 | | | 1206 | | | | 1210 | | | | | 1808 | | | | | | | | 1812 | | | | | | | | |
|---------------|--|-----|------|---|-----|------|------|--|-----|-----|------|------|--|-----|-----|------|------|------|------|------|--|-----|-----|------|------|------|------|------|------|
| | Soldering | | | Reflow/Wave | | | | Reflow Only | | | | | Reflow Only | | | | | | | | Reflow Only | | | | | | | | |
| (L) Length | mm (in.) 2.10 ± 0.20 (0.085 ± 0.008) | | | mm (in.) 3.30 ± 0.30 (0.130 ± 0.012) | | | | mm (in.) 3.30 ± 0.40 (0.130 ± 0.016) | | | | | mm (in.) 4.60 ± 0.50 (0.181 ± 0.020) | | | | | | | | mm (in.) 4.60 ± 0.50 (0.177 ± 0.012) | | | | | | | | |
| W) Width | mm (in.) 1.25 ± 0.20 (0.049 ± 0.008) | | | mm (in.) 1.60 ± 0.30/-0.10 (0.063 ± 0.012/-0.004) | | | | mm (in.) 2.50 ± 0.30 (0.098 ± 0.012) | | | | | mm (in.) 2.00 ± 0.20 (0.079 ± 0.008) | | | | | | | | mm (in.) 3.20 ± 0.30 (0.126 ± 0.008) | | | | | | | | |
| (T) Thickness | mm (in.) 1.35 (0.053) | | | mm (in.) 1.80 (0.071) | | | | mm (in.) 2.80 (0.110) | | | | | mm (in.) 2.20 (0.087) | | | | | | | | mm (in.) 2.80 (0.100) | | | | | | | | |
| (t) Terminal | mm max 0.50 ± 0.20 (0.020 ± 0.008) | | | mm max 0.60 ± 0.20 (0.024 ± 0.008) | | | | mm max 0.75 ± 0.35 (0.030 ± 0.014) | | | | | mm max 0.75 ± 0.35 (0.030 ± 0.014) | | | | | | | | mm max 0.75 ± 0.35 (0.030 ± 0.014) | | | | | | | | |
| Voltage (V) | 600 | 630 | 1000 | 600 | 630 | 1000 | 1500 | 2000 | 600 | 630 | 1000 | 1500 | 2000 | 600 | 630 | 1000 | 1500 | 2000 | 2500 | 3000 | 4000 | 600 | 630 | 1000 | 1500 | 2000 | 2500 | 3000 | 4000 |
| Cap (pF) | 100 | 101 | X | X | C | C | C | E | E | E | E | E | E | E | E | E | E | E | E | E | E | E | E | E | E | E | E | E | |
| | 120 | 121 | X | X | C | C | C | E | E | E | E | E | E | E | E | E | E | E | E | E | E | E | E | E | E | E | E | E | |
| | 150 | 151 | X | X | C | C | C | E | E | E | E | E | E | E | E | E | E | E | E | E | E | E | E | E | E | E | E | E | |
| | 180 | 181 | X | X | C | C | C | E | E | E | E | E | E | E | E | E | E | E | E | E | E | E | E | E | E | E | E | E | |
| | 220 | 221 | X | X | C | C | C | E | E | E | E | E | E | E | E | E | E | E | E | E | E | E | E | E | E | E | E | E | |
| | 270 | 271 | X | X | C | C | C | E | E | E | E | E | E | E | E | E | E | E | E | E | E | E | E | E | E | E | E | E | |
| | 330 | 331 | X | X | C | C | C | E | E | E | E | E | E | E | E | E | E | E | E | E | E | E | E | E | E | E | E | E | |
| | 390 | 391 | X | X | C | C | C | E | E | E | E | E | E | E | E | E | E | E | E | E | E | E | E | E | E | E | E | E | |
| | 470 | 471 | X | X | C | C | C | E | E | E | E | E | E | E | E | E | E | E | E | E | E | E | E | E | E | E | E | E | |
| | 560 | 561 | X | X | C | C | C | E | E | E | E | E | E | E | E | E | E | E | E | E | E | E | E | E | E | E | E | E | |
| | 680 | 681 | X | X | C | C | C | E | E | E | E | E | E | E | E | E | E | E | E | E | E | E | E | E | E | E | E | E | |
| | 750 | 751 | X | X | C | C | C | E | E | E | E | E | E | E | E | E | E | E | E | E | E | E | E | E | E | E | E | E | |
| | 820 | 821 | X | X | C | C | C | E | E | E | E | E | E | E | E | E | E | E | E | E | E | E | E | E | E | E | E | E | |
| | 1000 | 102 | X | X | C | C | C | E | E | E | E | E | E | E | E | E | E | E | E | E | E | E | E | E | E | E | E | E | |
| | 1200 | 122 | X | X | X | C | C | E | E | E | E | E | E | E | E | E | E | E | E | E | E | E | E | E | E | E | E | E | |
| | 1500 | 152 | X | X | X | C | C | E | E | E | E | E | E | E | E | E | E | E | E | E | E | E | E | E | E | E | E | E | |
| | 1800 | 182 | X | X | X | C | C | E | E | E | E | E | E | E | E | E | E | E | E | E | E | E | E | E | E | E | E | E | |
| | 2200 | 222 | X | X | X | C | C | E | E | E | E | E | E | E | E | E | E | E | E | E | E | E | E | E | E | E | E | E | |
| | 2700 | 272 | C | C | | C | C | E | E | | | E | E | E | F | E | E | E | F | F | F | F | F | F | F | F | F | F | |
| | 3300 | 332 | C | C | | C | C | E | E | | | E | E | E | F | E | E | E | F | F | F | F | F | F | F | F | F | F | |
| | 3900 | 392 | C | C | | C | C | E | E | | | E | E | E | F | E | E | E | F | F | F | F | F | F | F | F | F | F | |
| | 4700 | 472 | C | C | | C | C | E | E | | | E | E | E | F | E | E | E | F | F | F | F | F | F | F | F | F | F | |
| | 5600 | 562 | C | C | | C | C | E | E | | | E | E | E | F | E | E | E | F | F | F | F | F | F | F | F | F | F | |
| | 6800 | 682 | C | C | | C | C | E | E | | | E | E | E | | E | E | E | F | F | F | F | F | F | F | F | F | F | |
| | 8200 | 822 | C | C | | C | C | E | E | | | E | E | E | | E | E | E | | F | F | F | F | F | F | F | F | F | |
| Cap (μF) | 0.010 | 103 | C | C | | C | C | E | E | | | E | E | E | | E | E | E | | F | F | F | F | F | F | F | F | F | |
| | 0.015 | 153 | C | C | | E | E | E | | | | E | E | E | | F | F | F | | F | F | F | | | | | | | |
| | 0.018 | 183 | C | C | | E | E | E | | | | E | E | E | | F | F | F | | F | F | F | | | | | | | |
| | 0.022 | 223 | C | C | | E | E | | | | | E | E | F | | F | F | | | F | F | G | | | | | | | |
| | 0.027 | 273 | | | | E | E | | | | | E | E | | | F | F | | | F | F | G | | | | | | | |
| | 0.033 | 333 | | | | E | E | | | | | E | E | | | F | F | | | F | F | G | | | | | | | |
| | 0.039 | 393 | | | | | | | | | | E | E | | | F | F | | | F | F | G | | | | | | | |
| | 0.047 | 473 | | | | | | | | | | E | E | | | F | F | | | F | F | G | | | | | | | |
| | 0.056 | 563 | | | | | | | | | | F | F | | | F | F | | | F | F | | | | | | | | |
| | 0.068 | 683 | | | | | | | | | | F | F | | | F | F | | | F | F | | | | | | | | |
| | 0.082 | 823 | | | | | | | | | | F | F | | | F | F | | | F | F | | | | | | | | |
| | 0.100 | 104 | | | | | | | | | | F | F | | | F | F | | | F | F | | | | | | | | |
| | 0.150 | 154 | | | | | | | | | | | | | | | | | | | | | | G | G | | | | |
| | 0.220 | 224 | | | | | | | | | | | | | | | | | | | | | G | G | | | | | |
| | 0.270 | 274 | | | | | | | | | | | | | | | | | | | | | | | | | | | |
| | 0.330 | 334 | | | | | | | | | | | | | | | | | | | | | | | | | | | |
| | 0.390 | 394 | | | | | | | | | | | | | | | | | | | | | | | | | | | |
| | 0.470 | 474 | | | | | | | | | | | | | | | | | | | | | | | | | | | |
| | 0.560 | 564 | | | | | | | | | | | | | | | | | | | | | | | | | | | |
| | 0.680 | 684 | | | | | | | | | | | | | | | | | | | | | | | | | | | |
| | 0.820 | 824 | | | | | | | | | | | | | | | | | | | | | | | | | | | |
| | 1.000 | 105 | | | | | | | | | | | | | | | | | | | | | | | | | | | |
| Voltage (V) | 600 | 630 | 1000 | 600 | 630 | 1000 | 1500 | 2000 | 600 | 630 | 1000 | 1500 | 2000 | 600 | 630 | 1000 | 1500 | 2000 | 2500 | 3000 | 4000 | 600 | 630 | 1000 | 1500 | 2000 | 2500 | 3000 | 4000 |

| Letter | A | C | E | F | G | X | 7 |
|----------------|------------------|------------------|-------------------|-------------------|------------------|------------------|-----------------|
| Max. Thickness | 0.813 (0.032) | 1.448 (0.057) | 1.8034 (0.071) | 2.2098 (0.087) | 2.794 (0.110) | 0.940 (0.037) | 3.30 (0.130) |

NOTE: Contact factory for non-specified capacitance values



The Important Information/Disclaimer is incorporated in the catalog where these specifications came from or available online at www.avx.com/disclaimer/ by reference and should be reviewed in full before placing any order.

High Voltage MLC Chips

For 600V to 5000V Applications



X7R CAPACITANCE RANGE

PREFERRED SIZES ARE SHADED

| Case Size | 1825 | | | | | | | | 2220 | | | | | | | | 2225 | | | | | | | | 3640 | | | | | | | | | | |
|------------------|-----------------|-----|------|------|------|------|------|------|-----------------|-----|------|------|------|------|------|------|-----------------|-----|-----|------|------|------|------|------|--------------|------|-----|-----|------|------|------|------|------|------|------|
| Soldering | Reflow Only | | | | | | | | Reflow Only | | | | | | | | Reflow Only | | | | | | | | Reflow Only | | | | | | | | | | |
| (L) Length | 4.60 ± 0.50 | | | | | | | | 5.70 ± 0.50 | | | | | | | | 5.70 ± 0.50 | | | | | | | | 9.14 ± 0.25 | | | | | | | | | | |
| (W) Width | 6.30 ± 0.40 | | | | | | | | 5.00 ± 0.40 | | | | | | | | 6.30 ± 0.40 | | | | | | | | 10.2 ± 0.25 | | | | | | | | | | |
| (T) Thickness | 3.40 | | | | | | | | 3.40 | | | | | | | | 3.40 | | | | | | | | 2.54 | | | | | | | | | | |
| (t) Terminal max | 0.75 ± 0.35 | | | | | | | | 0.85 ± 0.35 | | | | | | | | 0.85 ± 0.35 | | | | | | | | 0.76 (0.030) | | | | | | | | | | |
| (t) Terminal | (0.030 ± 0.014) | | | | | | | | (0.033 ± 0.014) | | | | | | | | (0.033 ± 0.014) | | | | | | | | 1.52 (0.060) | | | | | | | | | | |
| Voltage (V) | 600 | 630 | 1000 | 1500 | 2000 | 2500 | 3000 | 4000 | 600 | 630 | 1000 | 1500 | 2000 | 2500 | 3000 | 4000 | 5000 | 600 | 630 | 1000 | 1500 | 2000 | 2500 | 3000 | 4000 | 5000 | 600 | 630 | 1000 | 1500 | 2000 | 2500 | 3000 | 4000 | 5000 |
| Cap (pF) | 100 | 101 | | | | | | | | | | | | | | | | | | | | | | | | | | | | | | | | | |
| | 120 | 121 | | | | | | | | | | | | | | | | | | | | | | | | | | | | | | | | | |
| | 150 | 151 | | | | | | | | | | | | | | | | | | | | | | | | | | | | | | | | | |
| | 180 | 181 | | | | | | | | | | | | | | | | | | | | | | | | | | | | | | | | | |
| | 220 | 221 | | | | | | | | | | | | | | | | | | | | | | | | | | | | | | | | | |
| | 270 | 271 | | | | | | | | | | | | | | | | | | | | | | | | | | | | | | | | | |
| | 330 | 331 | | | | | | | | | | | | | | | | | | | | | | | | | | | | | | | | | |
| | 390 | 391 | | | | | | | | | | | | | | | | | | | | | | | | | | | | | | | | | |
| | 470 | 471 | | | | | | | | | | | | | | | | | | | | | | | | | | | | | | | | | |
| | 560 | 561 | | | | | | | | | | | | | | | | | | | | | | | | | | | | | | | | | |
| | 680 | 681 | | | | | | | | | | | | | | | | | | | | | | | | | | | | | | | | | |
| | 750 | 751 | | | | | | | | | | | | | | | | | | | | | | | | | | | | | | | | | |
| | 820 | 821 | | | | | | | | | | | | | | | | | | | | | | | | | | | | | | | | | |
| | 1000 | 102 | F | F | F | F | F | F | F | F | F | F | F | F | G | | F | F | F | F | F | F | F | | | | | | | | | | | | |
| | 1200 | 122 | F | F | F | F | F | F | F | F | F | F | F | F | G | | F | F | F | F | F | F | F | | G | G | G | G | G | G | G | G | G | | |
| | 1500 | 152 | F | F | F | F | F | F | F | F | F | F | F | F | G | | F | F | F | F | F | F | F | | G | G | G | G | G | G | G | G | G | | |
| | 1800 | 182 | F | F | F | F | F | F | F | F | F | F | F | F | G | | F | F | F | F | F | F | F | | G | G | G | G | G | G | G | G | G | | |
| | 2200 | 222 | F | F | F | F | F | F | F | F | F | F | F | F | G | | F | F | F | F | F | F | F | | G | G | G | G | G | G | G | G | G | | |
| | 2700 | 272 | F | F | F | F | F | F | F | F | F | F | F | F | G | | F | F | F | F | F | F | F | | G | G | G | G | G | G | G | G | G | | |
| | 3300 | 332 | F | F | F | F | F | F | F | F | F | F | F | F | G | | F | F | F | F | F | F | F | | G | G | G | G | G | G | G | G | G | | |
| | 3900 | 392 | F | F | F | F | F | F | F | F | F | F | F | F | G | | F | F | F | F | F | F | F | | G | G | G | G | G | G | G | G | G | | |
| | 4700 | 472 | F | F | F | F | F | F | F | F | F | F | F | F | G | | F | F | F | F | F | F | F | | G | G | G | G | G | G | G | G | G | | |
| | 5600 | 562 | F | F | F | F | F | F | F | F | F | F | F | F | G | | F | F | F | F | F | F | F | | G | G | G | G | G | G | G | G | G | | |
| | 6800 | 682 | F | F | F | G | G | G | F | F | F | F | G | G | G | | F | F | F | F | G | G | G | | G | G | G | G | G | G | G | G | G | | |
| | 8200 | 822 | F | F | F | G | G | G | F | F | F | G | G | G | G | | F | F | F | F | G | G | G | | G | G | G | G | G | G | G | G | G | | |
| Cap (μF) | 0.010 | 103 | F | F | F | G | G | G | F | F | F | G | G | G | G | | F | F | F | F | G | G | G | | G | G | G | G | G | G | G | G | G | | |
| | 0.015 | 153 | F | F | F | G | G | G | F | F | F | G | G | G | G | | F | F | F | G | G | G | G | | G | G | G | G | G | G | G | G | G | | |
| | 0.018 | 183 | F | F | F | G | G | | F | F | F | G | G | G | G | | F | F | F | G | G | G | G | | G | G | G | G | G | G | G | G | G | | |
| | 0.022 | 223 | F | F | F | G | G | | F | F | F | G | G | G | G | | F | F | F | G | G | G | G | | G | G | G | G | G | G | G | G | G | | |
| | 0.027 | 273 | F | F | F | G | | | F | F | F | G | G | G | | F | F | F | G | G | G | G | | G | G | G | G | G | G | G | G | G | | | |
| | 0.033 | 333 | F | F | F | G | | | F | F | F | G | | | | F | F | F | G | G | G | | G | G | G | G | | | | | | | | | |
| | 0.039 | 393 | F | F | F | G | | | F | F | F | G | | | F | F | F | G | | | G | G | G | G | | | | | | | | | | | |
| | 0.047 | 473 | F | F | F | P | | | F | F | F | G | | | F | F | F | G | | | G | G | G | G | | | | | | | | | | | |
| | 0.056 | 563 | F | F | F | G | | | F | F | F | G | | | F | F | F | G | | | G | G | G | G | | | | | | | | | | | |
| | 0.068 | 683 | F | F | G | | | | F | F | G | | | | F | F | F | G | | | G | G | G | G | | | | | | | | | | | |
| | 0.082 | 823 | F | F | G | | | | F | F | G | | | | F | F | G | | | G | G | | | | | | | | | | | | | | |
| | 0.100 | 104 | F | F | G | | | | F | F | G | | | | F | F | G | | | G | G | | | | | | | | | | | | | | |
| | 0.150 | 154 | F | F | | | | | F | F | G | | | | F | F | G | | | G | G | | | | | | | | | | | | | | |
| | 0.220 | 224 | F | F | | | | | F | F | G | | | | F | F | | | | G | G | | | | | | | | | | | | | | |
| | 0.270 | 274 | F | F | | | | | F | F | | | | | F | F | | | | G | G | | | | | | | | | | | | | | |
| | 0.330 | 334 | F | F | | | | | F | F | | | | | F | F | | | | G | G | | | | | | | | | | | | | | |
| | 0.390 | 394 | F | F | | | | | F | F | | | | | F | F | | | | G | G | | | | | | | | | | | | | | |
| | 0.470 | 474 | F | F | | | | | F | F | | | | | F | F | | | | G | G | | | | | | | | | | | | | | |
| | 0.560 | 564 | G | G | | | | | G | G | | | | | F | F | | | | G | G | | | | | | | | | | | | | | |
| | 0.680 | 684 | | | | | | | G | G | | | | | G | G | | | | | | | | | | | | | | | | | | | |
| | 0.820 | 824 | | | | | | | | | | | | | G | G | | | | | | | | | | | | | | | | | | | |
| | 1.000 | 105 | | | | | | | | | | | | | G | G | | | | | | | | | | | | | | | | | | | |
| Voltage (V) | 600 | 630 | 1000 | 1500 | 2000 | 2500 | 3000 | 4000 | 600 | 630 | 1000 | 1500 | 2000 | 2500 | 3000 | 4000 | 5000 | 600 | 630 | 1000 | 1500 | 2000 | 2500 | 3000 | 4000 | 5000 | 600 | 630 | 1000 | 1500 | 2000 | 2500 | 3000 | 4000 | 5000 |
| Case Size | 1825 | | | | | | | | 2220 | | | | | | | | 2225 | | | | | | | | 3640 | | | | | | | | | | |

| Letter | A | C | E | F | G | X | 7 |
|----------------|------------------|------------------|-------------------|-------------------|------------------|------------------|-----------------|
| Max. Thickness | 0.813 (0.032) | 1.448 (0.057) | 1.8034 (0.071) | 2.2098 (0.087) | 2.794 (0.110) | 0.940 (0.037) | 3.30 (0.130) |

NOTE: Contact factory for non-specified capacitance values



High Voltage MLC Chips

Tin/Lead Termination "B" - 600V to 5000V Applications

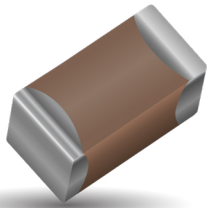

AVX Corporation will support those customers for commercial and military Multilayer Ceramic Capacitors with a termination consisting of 5% minimum lead. This termination is indicated by the use of a "B" in the 12th position of the AVX Catalog Part Number. This fulfills AVX's commitment to providing a full range of products to our customers. AVX has provided in the following pages, a full range of values that we are offering in this "B" termination.

Larger physical sizes than normally encountered chips are used to make high voltage MLC chip product. Special precautions must be taken in applying these chips in surface mount assemblies. The temperature gradient during heating or cooling cycles should not exceed 4°C per second.

The preheat temperature must be within 50°C of the peak temperature reached by the ceramic bodies through the soldering process. Chip sizes 1210 and larger should be reflow soldered only. Capacitors may require protective surface coating to prevent external arcing.

For 1825, 2225 and 3640 sizes, AVX offers leaded version in either thru-hole or SMT configurations (for details see section on high voltage leaded MLC chips).

NEW 630V RANGE

HOW TO ORDER

| LD08 | A | A | 271 | K | A | B | 1 | A |
|---|--|--------------------------------|--|---|---------------------------------|---|-------------------------------|---------------------|
| AVX Style | Voltage | Temperature Coefficient | Capacitance Code | Capacitance Tolerance | Test Level | Termination* | Packaging | Special Code |
| LD05 - 0805 LD06 - 1206 LD10 - 1210 LD08 - 1808 LD12 - 1812 LD13 - 1825 LD20 - 2220 LD14 - 2225 LD40 - 3640 | 600V/630V = C 1000V = A 1500V = S 2000V = G 2500V = W 3000V = H 4000V = J 5000V = K | COG = A X7R = C | (2 significant digits + no. of zeros) Examples: 10 pF = 100 100 pF = 101 1,000 pF = 102 22,000 pF = 223 220,000 pF = 224 1 μF = 105 | COG: J = ±5% K = ±10% M = ±20% X7R: K = ±10% M = ±20% Z = +80%, -20% | A = Standard 4 = Automotive* | B = 5% Min Pb X = FLEXITERM® 5% min. Pb | 2 = 7" Reel** 4 = 13" Reel | A = Standard |

Notes: Capacitors with X7R dielectrics are not intended for applications across AC supply mains or AC line filtering with polarity reversal. Contact plant for recommendations. Contact factory for availability of Termination and Tolerance options for Specific Part Numbers.

* FLEXITERM is not available in the LD40 Style

** The LD40 Style is not available on 7" Reels.

*** AVX offers nonstandard chip sizes. Contact factory for details.

* Not all values are supported in Automotive grade. Please contact factory for availability.

NOT RoHS Compliant

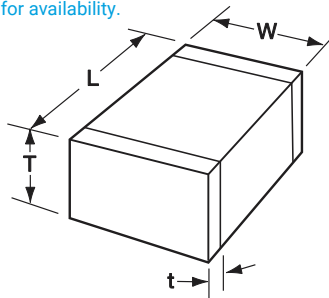

DIMENSIONS

millimeters (inches)

| SIZE | LD05 (0805) | LD06 (1206) | LD10* (1210) | LD08* (1808) | LD12* (1812) | LD13* (1825) | LD20* (2220) | LD14* (2225) | LD40* (3640) |
|---------------------------|--------------------------------|--------------------------------|--------------------------------|--------------------------------|--------------------------------|--------------------------------|--------------------------------|--------------------------------|--------------------------------|
| (L) Length | 2.10 ± 0.20 (0.083 ± 0.008) | 3.30 ± 0.30 (0.130 ± 0.012) | 3.30 ± 0.40 (0.130 ± 0.016) | 4.60 ± 0.50 (0.181 ± 0.020) | 4.60 ± 0.50 (0.181 ± 0.020) | 4.60 ± 0.50 (0.181 ± 0.020) | 5.70 ± 0.50 (0.224 ± 0.020) | 5.70 ± 0.50 (0.224 ± 0.020) | 9.14 ± 0.25 (0.360 ± 0.010) |
| (W) Width | 1.25 ± 0.20 (0.049 ± 0.008) | 1.60 ± 0.20 (0.063 ± 0.008) | 2.50 ± 0.30 (0.098 ± 0.012) | 2.00 ± 0.20 (0.079 ± 0.008) | 3.20 ± 0.30 (0.126 ± 0.012) | 6.30 ± 0.40 (0.248 ± 0.016) | 5.00 ± 0.40 (0.197 ± 0.016) | 6.30 ± 0.40 (0.248 ± 0.016) | 10.2 ± 0.25 (0.400 ± 0.010) |
| (T) Thickness Max. | 1.35 (0.053) | 1.80 (0.071) | 2.80 (0.110) | 2.20 (0.087) | 2.80 (0.110) | 3.40 (0.134) | 3.40 (0.134) | 3.40 (0.134) | 2.54 (0.100) |
| (t) min. terminal max. | 0.50 ± 0.20 (0.020 ± 0.008) | 0.60 ± 0.20 (0.024 ± 0.008) | 0.75 ± 0.35 (0.030 ± 0.014) | 0.75 ± 0.35 (0.030 ± 0.014) | 0.75 ± 0.35 (0.030 ± 0.014) | 0.75 ± 0.35 (0.030 ± 0.014) | 0.85 ± 0.35 (0.033 ± 0.014) | 0.85 ± 0.35 (0.033 ± 0.014) | 0.76 (0.030) 1.52 (0.060) |

*Reflow Soldering Only

Performance of ceramic capacitors can be simulated by using the online SpiMLCC software program - <http://spicat.avx.com/mlcc>
Custom values, ratings and configurations are also available.

High Voltage MLC Chips

Tin/Lead Termination "B" - 600V to 5000V Applications



NP0 (C0G) Dielectric

Performance Characteristics

| | |
|--|---|
| Capacitance Range | 10 pF to 0.047 μF (25°C, 1.0 ±0.2 Vrms at 1kHz, for ≤ 1000 pF use 1 MHz) |
| Capacitance Tolerances | ±5%, ±10%, ±20% |
| Dissipation Factor | 0.1% max. (+25°C, 1.0 ±0.2 Vrms, 1kHz, for ≤ 1000 pF use 1 MHz) |
| Operating Temperature Range | -55°C to +125°C |
| Temperature Characteristic | 0 ±30 ppm/°C (0 VDC) |
| Voltage Ratings | 600, 630, 1000, 1500, 2000, 2500, 3000, 4000 & 5000 VDC (+125°C) |
| Insulation Resistance (+25°C, at 500 VDC) | 100K MΩ min. or 1000 MΩ - μF min., whichever is less |
| Insulation Resistance (+125°C, at 500 VDC) | 10K MΩ min. or 100 MΩ - μF min., whichever is less |
| Dielectric Strength | Minimum 120% rated voltage for 5 seconds at 50 mA max. current |

HIGH VOLTAGE C0G CAPACITANCE VALUES

| VOLTAGE | | LD05 (0805) | LD06 (1206) | LD10 (1210) | LD08 (1808) | LD12 (1812) | LD13 (1825) | LD20 (2220) | LD14 (2225) | LD40 (3640) |
|---------|------|-------------|-------------|-------------|-------------|-------------|-------------|-------------|-------------|-------------|
| 600/630 | min. | 10 pF | 10 pF | 100 pF | 100 pF | 100 pF | 1000 pF | 1000 pF | 1000 pF | 1000 pF |
| | max. | 330 pF | 1200 pF | 2700 pF | 3300 pF | 5600 pF | 0.012 μF | 0.012 pF | 0.018 μF | 0.047 μF |
| 1000 | min. | 10 pF | 10 pF | 10 pF | 100 pF | 100 pF | 100 pF | 1000 pF | 1000 pF | 1000 pF |
| | max. | 180 pF | 560 pF | 1500 pF | 2200 pF | 3300 pF | 8200 pF | 0.010 pF | 0.010 μF | 0.022 μF |
| 1500 | min. | - | 10 pF | 10 pF | 10 pF | 10 pF | 100 pF | 100 pF | 100 pF | 100 pF |
| | max. | - | 270 pF | 680 pF | 820 pF | 1800 pF | 4700 pF | 4700 pF | 5600 pF | 0.010 μF |
| 2000 | min. | - | 10 pF | 10 pF | 10 pF | 10 pF | 100 pF | 100 pF | 100 pF | 100 pF |
| | max. | - | 120 pF | 270 pF | 330 pF | 1000 pF | 1800 pF | 2200 pF | 2700 pF | 6800 pF |
| 2500 | min. | - | - | - | 10 pF | 10 pF | 10 pF | 100 pF | 100 pF | 100 pF |
| | max. | - | - | - | 180 pF | 470 pF | 1200 pF | 1500 pF | 1800 pF | 3900 pF |
| 3000 | min. | - | - | - | 10 pF | 10 pF | 10 pF | 10 pF | 10 pF | 100 pF |
| | max. | - | - | - | 120 pF | 330 pF | 820 pF | 1000 pF | 1200 pF | 2700 pF |
| 4000 | min. | - | - | - | 10 pF | 10 pF | 10 pF | 10 pF | 10 pF | 100 pF |
| | max. | - | - | - | 47 pF | 150 pF | 330 pF | 470 pF | 560 pF | 1200 pF |
| 5000 | min. | - | - | - | - | - | - | 10 pF | 10 pF | 10 pF |
| | max. | - | - | - | - | - | - | 220 pF | 270 pF | 820 pF |

X7R Dielectric

Performance Characteristics

| | |
|--|--|
| Capacitance Range | 10 pF to 0.56 μF (25°C, 1.0 ±0.2 Vrms at 1kHz) |
| Capacitance Tolerances | ±10%; ±20%; +80%, -20% |
| Dissipation Factor | 2.5% max. (+25°C, 1.0 ±0.2 Vrms, 1kHz) |
| Operating Temperature Range | -55°C to +125°C |
| Temperature Characteristic | ±15% (0 VDC) |
| Voltage Ratings | 600, 630, 1000, 1500, 2000, 2500, 3000, 4000 & 5000 VDC (+125°C) |
| Insulation Resistance (+25°C, at 500 VDC) | 100K MΩ min. or 1000 MΩ - μF min., whichever is less |
| Insulation Resistance (+125°C, at 500 VDC) | 10K MΩ min. or 100 MΩ - μF min., whichever is less |
| Dielectric Strength | Minimum 120% rated voltage for 5 seconds at 50 mA max. current |

HIGH VOLTAGE X7R MAXIMUM CAPACITANCE VALUES

| VOLTAGE | | 0805 | 1206 | 1210 | 1808 | 1812 | 1825 | 2220 | 2225 | 3640 |
|---------|------|---------|----------|----------|----------|----------|----------|----------|----------|----------|
| 600/630 | min. | 100 pF | 1000 pF | 1000 pF | 1000 pF | 1000 pF | 0.010 μF | 0.010 μF | 0.010 μF | 0.010 μF |
| | max. | 6800 pF | 0.022 μF | 0.056 μF | 0.068 μF | 0.120 μF | 0.390 μF | 0.270 μF | 0.330 μF | 0.560 μF |
| 1000 | min. | 100 pF | 100 pF | 1000 pF | 1000 pF | 1000 pF | 1000 pF | 1000 pF | 1000 pF | 0.010 μF |
| | max. | 1500 pF | 6800 pF | 0.015 μF | 0.018 μF | 0.039 μF | 0.100 μF | 0.120 μF | 0.150 μF | 0.220 μF |
| 1500 | min. | - | 100 pF | 100 pF | 100 pF | 100 pF | 1000 pF | 1000 pF | 1000 pF | 1000 pF |
| | max. | - | 2700 pF | 5600 pF | 6800 pF | 0.015 μF | 0.056 μF | 0.056 μF | 0.068 μF | 0.100 μF |
| 2000 | min. | - | 10 pF | 100 pF | 100 pF | 100 pF | 100 pF | 1000 pF | 1000 pF | 1000 pF |
| | max. | - | 1500 pF | 3300 pF | 3300 pF | 8200 pF | 0.022 μF | 0.027 μF | 0.033 μF | 0.027 μF |
| 2500 | min. | - | - | - | 10 pF | 10 pF | 100 pF | 100 pF | 100 pF | 1000 pF |
| | max. | - | - | - | 2200 pF | 5600 pF | 0.015 μF | 0.018 μF | 0.022 μF | 0.022 μF |
| 3000 | min. | - | - | - | 10 pF | 10 pF | 100 pF | 100 pF | 100 pF | 1000 pF |
| | max. | - | - | - | 1800 pF | 3900 pF | 0.010 μF | 0.012 μF | 0.015 μF | 0.018 μF |
| 4000 | min. | - | - | - | - | - | - | - | - | 100 pF |
| | max. | - | - | - | - | - | - | - | - | 6800 pF |
| 5000 | min. | - | - | - | - | - | - | - | - | 100 pF |
| | max. | - | - | - | - | - | - | - | - | 3300 pF |

High Voltage MLC Chips

FLEXITERM® - 600V to 5000V Applications

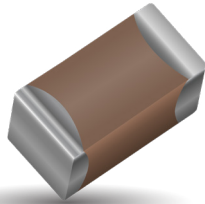

High value, low leakage and small size are difficult parameters to obtain in capacitors for high voltage systems. AVX special high voltage MLC chips capacitors meet these performance characteristics and are designed for applications such as snubbers in high frequency power converters, resonators in SMPS, and high voltage coupling/DC blocking. These high voltage chip designs exhibit low ESRs at high frequencies.

To make high voltage chips, larger physical sizes than are normally encountered are necessary. These larger sizes require that special precautions be taken in applying these chips in surface mount assemblies. In response to this, and to follow from the success of the FLEXITERM® range of low voltage parts, AVX is delighted to offer a FLEXITERM® high voltage range of capacitors, FLEXITERM®.

The FLEXITERM® layer is designed to enhance the mechanical flexure and temperature cycling performance of a standard ceramic capacitor, giving customers a solution where board flexure or temperature cycle damage are concerns.

HOW TO ORDER

| 1808 | A | C | 272 | K | A | Z | 1 | A |
|--|--|--------------------------------|--|---|-------------------|---|---|-------------------------------------|
| AVX Style | Voltage | Temperature Coefficient | Capacitance Code (2 significant digits + no. of zeros) Examples: | Capacitance Tolerance COG: J = ±5% K = ±10% M = ±20% X7R: K = ±10% M = ±20% Z = +80%, -20% | Test Level | Termination* Z = FLEXITERM® 100% Tin (RoHS Compliant) | Packaging 2 = 7" Reel 4 = 13" Reel | Special Code A = Standard |
| 0805 1206 1210 1808 1812 1825 2220 2225 | 600V/630V = C 1000V = A 1500V = S 2000V = G 2500V = W 3000V = H 4000V = J 5000V = K | COG = A X7R = C | 10 pF = 100 100 pF = 101 1,000 pF = 102 22,000 pF = 223 220,000 pF = 224 1 μF = 105 | | | | | |
| *** | | | | | | | | |

Notes: Capacitors with X7R dielectrics are not intended for applications across AC supply mains or AC line filtering with polarity reversal. Contact plant for recommendations. Contact factory for availability of Termination and Tolerance options for Specific Part Numbers.

*** AVX offers nonstandard chip sizes. Contact factory for details.

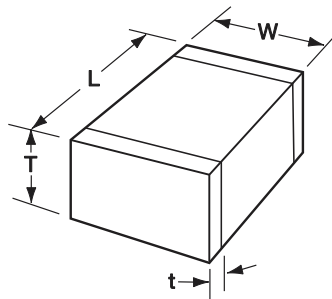

DIMENSIONS

MILLIMETERS (INCHES)

| SIZE | 0805 | 1206 | 1210* | 1808* | 1812* | 1825* | 2220* | 2225* |
|--------------------|--------------------------------|--|--------------------------------|--------------------------------|--------------------------------|--------------------------------|--------------------------------|--------------------------------|
| (L) Length | 2.10 ± 0.20 (0.083 ± 0.008) | 3.30 ± 0.30 (0.130 ± 0.012) | 3.30 ± 0.40 (0.130 ± 0.016) | 4.60 ± 0.50 (0.181 ± 0.020) | 4.60 ± 0.50 (0.181 ± 0.020) | 4.60 ± 0.50 (0.181 ± 0.020) | 5.70 ± 0.50 (0.224 ± 0.020) | 5.70 ± 0.50 (0.224 ± 0.020) |
| (W) Width | 1.25 ± 0.20 (0.049 ± 0.008) | 1.60 ^{+0.30} _{-0.10} (0.063 ^{+0.012} _{-0.004}) | 2.50 ± 0.30 (0.098 ± 0.012) | 2.00 ± 0.20 (0.079 ± 0.008) | 3.20 ± 0.30 (0.126 ± 0.012) | 6.30 ± 0.40 (0.248 ± 0.016) | 5.00 ± 0.40 (0.197 ± 0.016) | 6.30 ± 0.40 (0.248 ± 0.016) |
| (T) Thickness Max. | 1.35 (0.053) | 1.80 (0.071) | 2.80 (0.110) | 2.20 (0.087) | 2.80 (0.110) | 3.40 (0.134) | 3.40 (0.134) | 3.40 (0.134) |
| (t) terminal | min. max. | 0.50 ± 0.20 (0.020 ± 0.008) | 0.60 ± 0.20 (0.024 ± 0.008) | 0.75 ± 0.35 (0.030 ± 0.014) | 0.75 ± 0.35 (0.030 ± 0.014) | 0.75 ± 0.35 (0.030 ± 0.014) | 0.85 ± 0.35 (0.033 ± 0.014) | 0.85 ± 0.35 (0.033 ± 0.014) |

*Reflow Soldering Only



Performance of SMPS capacitors can be simulated by downloading SpiCalci software program - <http://www.avx.com/SpiApps/default.asp#spicalci>
Custom values, ratings and configurations are also available.



The Important Information/Disclaimer is incorporated in the catalog where these specifications came from or available online at www.avx.com/disclaimer/ by reference and should be reviewed in full before placing any order.

High Voltage MLC Chips

FLEXITERM[®] - 600V to 5000V Applications



NP0 (C0G) CAPACITANCE RANGE

PREFERRED SIZES ARE SHADED

| Case Size | 1825 | | | | | | | | 2220 | | | | | | | | 2225 | | | | | | | | | | | |
|---------------|-------------|-----------------|-----|------|------|------|------|------|-------------|-----------------|-----|------|------|------|------|------|-------------|-----------------|-----|-----|------|------|------|------|------|------|------|---|
| | Reflow Only | | | | | | | | Reflow Only | | | | | | | | Reflow Only | | | | | | | | | | | |
| (L) Length | mm | 4.60 ± 0.50 | | | | | | | | 5.70 ± 0.50 | | | | | | | | 5.72 ± 0.25 | | | | | | | | | | |
| (L) Length | (in.) | (0.181 ± 0.020) | | | | | | | | (0.224 ± 0.020) | | | | | | | | (0.225 ± 0.010) | | | | | | | | | | |
| (W) Width | mm | 6.30 ± 0.40 | | | | | | | | 5.00 ± 0.40 | | | | | | | | 6.35 ± 0.25 | | | | | | | | | | |
| (W) Width | (in.) | (0.248 ± 0.016) | | | | | | | | (0.197 ± 0.016) | | | | | | | | (0.250 ± 0.010) | | | | | | | | | | |
| (T) Thickness | mm | 3.40 | | | | | | | | 3.40 | | | | | | | | 3.40 | | | | | | | | | | |
| (T) Thickness | (in.) | (0.134) | | | | | | | | (0.134) | | | | | | | | (0.134) | | | | | | | | | | |
| (t) Terminal | mm | 0.75 ± 0.35 | | | | | | | | 0.85 ± 0.35 | | | | | | | | 0.85 ± 0.35 | | | | | | | | | | |
| (t) Terminal | max | (0.030 ± 0.014) | | | | | | | | (0.033 ± 0.014) | | | | | | | | | | | | | | | | | | |
| Voltage (V) | | 600 | 630 | 1000 | 1500 | 2000 | 2500 | 3000 | 4000 | 600 | 630 | 1000 | 1500 | 2000 | 2500 | 3000 | 4000 | 5000 | 600 | 630 | 1000 | 1500 | 2000 | 2500 | 3000 | 4000 | 5000 | |
| Cap (pF) | 1.5 1R5 | | | | | | | | | | | | | | | | | | | | | | | | | | | |
| | 1.8 1R8 | | | | | | | | | | | | | | | | | | | | | | | | | | | |
| | 2.2 2R2 | | | | | | | | | | | | | | | | | | | | | | | | | | | |
| | 2.7 2R7 | | | | | | | | | | | | | | | | | | | | | | | | | | | |
| | 3.3 3R3 | | | | | | | | | | | | | | | | | | | | | | | | | | | |
| | 3.9 3R9 | | | | | | | | | | | | | | | | | | | | | | | | | | | |
| | 4.7 4R7 | | | | | | | | | | | | | | | | | | | | | | | | | | | |
| | 5.6 5R6 | | | | | | | | | | | | | | | | | | | | | | | | | | | |
| | 6.8 6R8 | | | | | | | | | | | | | | | | | | | | | | | | | | | |
| | 8.2 8R2 | | | | | | | | | | | | | | | | | | | | | | | | | | | |
| | 10 100 | E | E | E | E | E | E | E | E | E | E | E | E | E | E | E | E | E | E | E | E | E | E | E | E | F | F | |
| | 12 120 | E | E | E | E | E | E | E | E | E | E | E | E | E | E | E | E | E | E | E | E | E | E | E | E | E | F | F |
| | 15 150 | E | E | E | E | E | E | E | E | E | E | E | E | E | E | E | E | E | E | E | E | E | E | E | E | E | F | F |
| | 18 180 | E | E | E | E | E | E | E | E | E | E | E | E | E | E | E | E | E | E | E | E | E | E | E | E | E | F | F |
| | 22 220 | E | E | E | E | E | E | E | E | E | E | E | E | E | E | E | E | E | E | E | E | E | E | E | E | E | F | F |
| | 27 270 | E | E | E | E | E | E | E | E | E | E | E | E | E | E | E | E | E | E | E | E | E | E | E | E | E | F | F |
| | 33 330 | E | E | E | E | E | E | E | E | E | E | E | E | E | E | E | E | E | E | E | E | E | E | E | E | E | F | F |
| | 39 390 | E | E | E | E | E | E | E | E | E | E | E | E | E | E | E | E | E | E | E | E | E | E | E | E | E | F | F |
| | 47 470 | E | E | E | E | E | E | E | F | E | E | E | E | E | E | E | E | E | E | E | E | E | E | E | E | E | F | G |
| | 56 560 | E | E | E | E | E | E | F | E | E | E | E | E | E | E | E | E | E | E | E | E | E | E | E | E | E | F | G |
| | 68 680 | E | E | E | E | E | E | F | E | E | E | E | E | E | E | E | E | E | E | E | E | E | E | E | E | E | F | G |
| | 82 820 | E | E | E | E | E | E | F | E | E | E | E | E | E | E | E | E | E | E | E | E | E | E | E | E | E | F | G |
| | 100 101 | E | E | E | E | E | E | F | E | E | E | E | E | E | E | E | E | E | E | E | E | E | E | E | E | E | G | G |
| | 120 121 | E | E | E | E | E | E | F | E | E | E | E | E | E | E | E | E | E | E | E | E | E | E | E | E | E | G | G |
| | 150 151 | E | E | E | E | E | E | F | E | E | E | E | E | E | E | E | E | E | E | E | E | E | E | E | E | E | G | G |
| | 180 181 | E | E | E | E | E | E | F | E | E | E | E | E | E | E | E | F | F | E | E | E | E | E | E | E | E | G | G |
| | 220 221 | E | E | E | E | E | E | F | E | E | E | E | E | E | E | F | F | E | E | E | E | E | E | E | E | E | G | G |
| | 270 271 | E | E | E | E | E | E | F | E | E | E | E | E | E | E | | | E | E | E | E | E | E | E | E | E | G | G |
| | 330 331 | E | E | E | E | E | E | F | E | E | E | E | E | E | | | | | E | E | E | E | E | E | E | E | G | |
| | 390 391 | E | E | E | E | E | E | | E | E | E | E | E | E | | | | | E | E | E | E | E | E | E | E | G | |
| | 470 471 | E | E | E | E | E | E | | E | E | E | E | E | E | | | | | E | E | E | E | E | E | E | E | G | |
| | 560 561 | E | E | E | E | E | E | | E | E | E | E | E | E | | | | | E | E | E | E | E | E | E | E | G | |
| | 680 681 | E | E | E | E | E | F | F | E | E | E | E | F | F | | | | | E | E | E | E | E | E | E | E | | |
| | 750 751 | E | E | E | E | E | F | F | E | E | E | E | F | F | | | | | E | E | E | E | E | E | E | E | | |
| | 820 821 | E | E | E | E | E | F | F | E | E | E | E | F | F | | | | | E | E | E | E | E | F | E | E | | |
| | 1000 102 | E | E | E | E | E | F | F | E | E | E | E | F | F | | | | | E | E | E | E | E | E | E | E | | |
| | 1200 122 | E | E | E | E | E | G | G | E | E | E | E | G | G | | | | | E | E | E | E | F | F | E | E | | |
| | 1500 152 | E | E | E | F | F | G | G | E | E | E | F | F | G | G | | | | E | E | E | E | E | F | F | E | | |
| | 1800 182 | E | E | E | F | F | G | G | E | E | E | F | F | G | G | | | | E | E | E | E | E | G | G | E | | |
| | 2200 222 | E | E | E | G | G | | | E | E | E | G | G | | | | | | E | E | E | E | | | | | | |
| | 2700 272 | E | E | E | G | G | | | E | E | E | G | G | | | | | | E | E | E | F | F | | | | | |
| | 3300 332 | E | E | E | G | G | | | E | E | E | G | G | | | | | | E | E | E | F | F | | | | | |
| | 3900 392 | E | E | E | G | G | | | E | E | E | G | G | | | | | | E | E | E | G | G | | | | | |
| | 4700 472 | E | E | E | G | G | | | E | E | E | G | G | | | | | | F | F | F | G | G | | | | | |
| | 5600 562 | F | F | F | G | G | | | F | F | F | | | | | | | | F | F | F | G | G | | | | | |
| | 6800 682 | F | F | F | | | | | F | F | F | | | | | | | | F | F | F | G | G | | | | | |
| | 8200 822 | G | G | G | | | | | G | G | G | | | | | | | | G | G | G | | | | | | | |
| Cap (μF) | 0.010 103 | | | | | | | | | | | | | | | | | | | | | | | | | | | |
| | 0.012 123 | | | | | | | | | | | | | | | | | | | | | | | | | | | |
| | 0.015 153 | | | | | | | | | | | | | | | | | | | | | | | | | | | |
| | 0.018 183 | | | | | | | | | | | | | | | | | | | | | | | | | | | |
| | 0.022 223 | | | | | | | | | | | | | | | | | | | | | | | | | | | |
| | 0.033 333 | | | | | | | | | | | | | | | | | | | | | | | | | | | |
| | 0.047 473 | | | | | | | | | | | | | | | | | | | | | | | | | | | |
| | 0.056 563 | | | | | | | | | | | | | | | | | | | | | | | | | | | |
| | 0.068 683 | | | | | | | | | | | | | | | | | | | | | | | | | | | |
| | 0.100 104 | | | | | | | | | | | | | | | | | | | | | | | | | | | |
| Voltage (V) | | 600 | 630 | 1000 | 1500 | 2000 | 2500 | 3000 | 4000 | 600 | 630 | 1000 | 1500 | 2000 | 2500 | 3000 | 4000 | 5000 | 600 | 630 | 1000 | 1500 | 2000 | 2500 | 3000 | 4000 | 5000 | |
| Case Size | | 1825 | | | | | | | | 2220 | | | | | | | | 2225 | | | | | | | | | | |

| | | | | | | |
|-----------|---------|---------|---------|---------|---------|---------|
| Letter | A | C | E | F | G | X |
| Max. | 0.813 | 1.448 | 1.803 | 2.210 | 2.794 | 0.940 |
| Thickness | (0.032) | (0.057) | (0.071) | (0.087) | (0.110) | (0.037) |

NOTE: Contact factory for non-specified capacitance



The Important Information/Disclaimer is incorporated in the catalog where these specifications came from or available online at www.avx.com/disclaimer/ by reference and should be reviewed in full before placing any order.

High Voltage MLC Chips

FLEXITERM[®] - 600V to 5000V Applications



X7R Dielectric

Performance Characteristics

| | |
|---|--|
| Capacitance Range | 10 pF to 0.82 μF (25°C, 1.0 ±0.2 Vrms at 1kHz) |
| Capacitance Tolerances | ±10%; ±20%; +80%, -20% |
| Dissipation Factor | 2.5% max. (+25°C, 1.0 ±0.2 Vrms, 1kHz) |
| Operating Temperature Range | -55°C to +125°C |
| Temperature Characteristic | ±15% (0 VDC) |
| Voltage Ratings | 600, 630, 1000, 1500, 2000, 2500, 3000, 4000 & 5000 VDC (+125°C) |
| Insulation Resistance (+25°C, at 500 VDC) | 100K MΩ min. or 1000 MΩ - μF min., whichever is less |
| Insulation Resistance (+125°C, at 500 VDC) | 10K MΩ min. or 100 MΩ - μF min., whichever is less |
| Dielectric Strength | Minimum 120% rated voltage for 5 seconds at 50 mA max. current |

X7R CAPACITANCE RANGE

PREFERRED SIZES ARE SHADED

| Case Size Soldering | 0805 | | | | | | 1206 | | | | | 1210 | | | | | 1808 | | | | | | 1812 | | | | | | |
|------------------------|---------------------------|-----|------|-----|-----|------|--|------|-----|-----|------|---------------------------|------|-----|-----|------|---------------------------|------|------|------|------|-----|---------------------------|------|------|------|------|------|------|
| | Reflow/Wave | | | | | | Reflow/Wave | | | | | Reflow Only | | | | | Reflow Only | | | | | | Reflow Only | | | | | | |
| (L) Length mm (in.) | 2.10 ±0.20 (0.083 ±0.008) | | | | | | 3.30 ±0.30 (0.130 ±0.012) | | | | | 3.30 ±0.40 (0.130 ±0.016) | | | | | 4.60 ±0.50 (0.181 ±0.020) | | | | | | 4.60 ±0.50 (0.181 ±0.020) | | | | | | |
| W) Width mm (in.) | 1.25 ±0.20 (0.049 ±0.008) | | | | | | 1.60 ±0.30/-0.10 (0.063 ±0.012/-0.004) | | | | | 2.50 ±0.30 (0.098 ±0.012) | | | | | 2.00 ±0.20 (0.079 ±0.008) | | | | | | 3.20 ±0.30 (0.126 ±0.012) | | | | | | |
| (T) Thickness mm (in.) | 1.35 (0.053) | | | | | | 1.80 (0.071) | | | | | 2.80 (0.110) | | | | | 2.20 (0.087) | | | | | | 2.80 (0.110) | | | | | | |
| (t) Terminal mm max | 0.50 ±0.20 (0.020 ±0.008) | | | | | | 0.60 ±0.20 (0.024 ±0.008) | | | | | 0.75 ±0.35 (0.030 ±0.014) | | | | | 0.75 ±0.35 (0.030 ±0.014) | | | | | | 0.75 ±0.35 (0.030 ±0.014) | | | | | | |
| Voltage (V) | 600 | 630 | 1000 | 600 | 630 | 1000 | 1500 | 2000 | 600 | 630 | 1000 | 1500 | 2000 | 600 | 630 | 1000 | 1500 | 2000 | 2500 | 3000 | 4000 | 600 | 630 | 1000 | 1500 | 2000 | 2500 | 3000 | 4000 |
| Cap (pF) 100 101 | X | X | C | C | C | C | E | E | E | E | E | E | E | E | E | E | E | E | E | E | F | E | E | E | E | E | | | |
| 120 121 | X | X | C | C | C | C | E | E | E | E | E | E | E | E | E | E | E | E | E | E | F | E | E | E | E | E | E | | |
| 150 151 | X | X | C | C | C | C | E | E | E | E | E | E | E | E | E | E | E | E | E | E | F | E | E | E | E | E | E | | |
| 180 181 | X | X | C | C | C | C | E | E | E | E | E | E | E | E | E | E | E | E | E | E | F | E | E | E | E | E | E | | |
| 220 221 | X | X | C | C | C | C | E | E | E | E | E | E | E | E | E | E | E | E | E | E | F | E | E | E | E | E | E | | |
| 270 271 | X | X | C | C | C | C | E | E | E | E | E | E | E | E | E | E | E | E | E | E | F | E | E | E | E | E | E | | |
| 330 331 | X | X | C | C | C | C | E | E | E | E | E | E | E | E | E | E | E | E | E | E | F | E | E | E | E | E | E | | |
| 390 391 | X | X | C | C | C | C | E | E | E | E | E | E | E | E | E | E | E | E | E | E | F | E | E | E | E | E | E | | |
| 470 471 | X | X | C | C | C | C | E | E | E | E | E | E | E | E | E | E | E | E | E | E | F | E | E | E | E | E | E | E | |
| 560 561 | X | X | C | C | C | C | E | E | E | E | E | E | E | E | E | E | E | E | E | E | F | E | E | E | E | E | E | E | |
| 680 681 | X | X | C | C | C | C | E | E | E | E | E | E | E | E | E | E | E | E | E | E | F | E | E | E | E | E | E | E | |
| 750 751 | X | X | C | C | C | C | E | E | E | E | E | E | E | E | E | E | E | E | E | E | F | E | E | E | E | E | E | E | |
| 820 821 | X | X | C | C | C | C | E | E | E | E | E | E | E | E | E | E | E | E | E | E | F | E | E | E | E | E | E | E | |
| 1000 102 | X | X | C | C | C | C | E | E | E | E | E | E | E | E | E | E | E | E | E | E | F | E | E | E | E | E | E | E | |
| 1200 122 | X | X | C | C | C | C | E | E | E | E | E | E | E | E | E | E | E | E | E | E | F | E | E | E | E | E | E | E | |
| 1500 152 | X | X | C | C | C | C | E | E | E | E | E | E | E | E | E | E | E | E | E | E | F | E | E | E | E | E | E | E | |
| 1800 182 | X | X | | C | C | C | E | E | E | E | E | E | E | E | E | E | E | E | E | E | F | E | E | E | E | E | E | E | |
| 2200 222 | X | X | | C | C | C | E | E | E | E | E | E | E | E | E | E | E | E | E | E | F | E | E | E | E | E | E | E | |
| 2700 272 | X | X | | C | C | C | E | E | E | E | E | E | E | E | E | E | E | E | E | E | F | E | E | E | E | E | E | E | |
| 3300 332 | X | X | | C | C | C | E | E | E | E | E | E | E | E | E | E | E | E | E | E | F | E | E | E | E | E | E | E | |
| 3900 392 | X | X | | C | C | C | E | E | E | E | E | E | E | E | E | E | E | E | E | E | F | E | E | E | E | E | E | E | |
| 4700 472 | X | X | | C | C | C | E | E | E | E | E | E | E | E | E | E | E | E | E | E | F | E | E | E | E | E | E | E | |
| 5600 562 | X | X | | C | C | C | E | E | E | E | E | E | E | E | E | E | E | E | E | E | F | E | E | E | E | E | E | E | |
| 6800 682 | X | X | | C | C | C | E | E | E | E | E | E | E | E | E | E | E | E | E | E | F | E | E | E | E | E | E | E | |
| 8200 822 | X | X | | C | C | C | E | E | E | E | E | E | E | E | E | E | E | E | E | E | F | E | E | E | E | E | E | E | |
| Cap (μF) 0.010 103 | C | C | | C | C | C | E | E | E | E | E | E | E | E | E | E | E | E | E | E | F | E | E | E | E | E | E | E | |
| 0.015 153 | C | C | | E | E | E | E | E | E | E | E | E | E | E | E | E | E | E | E | E | F | E | E | E | E | E | E | E | |
| 0.018 183 | C | C | | E | E | E | E | E | E | E | E | E | E | E | E | E | E | E | E | E | F | E | E | E | E | E | E | E | |
| 0.022 223 | C | C | | E | E | E | E | E | E | E | E | E | E | E | E | E | E | E | E | E | F | E | E | E | E | E | E | E | |
| 0.027 273 | | | | E | E | E | E | E | E | E | E | E | E | E | E | E | E | E | E | E | F | E | E | E | E | E | E | E | |
| 0.033 333 | | | | E | E | E | E | E | E | E | E | E | E | E | E | E | E | E | E | E | F | E | E | E | E | E | E | E | |
| 0.039 393 | | | | | | | E | E | E | E | E | E | E | E | E | E | E | E | E | E | F | E | E | E | E | E | E | E | |
| 0.047 473 | | | | | | | E | E | E | E | E | E | E | E | E | E | E | E | E | E | F | E | E | E | E | E | E | E | |
| 0.056 563 | | | | | | | F | F | F | F | F | F | F | F | F | F | F | F | F | F | F | E | E | E | E | E | E | E | |
| 0.068 683 | | | | | | | F | F | F | F | F | F | F | F | F | F | F | F | F | F | F | E | E | E | E | E | E | E | |
| 0.082 823 | | | | | | | F | F | F | F | F | F | F | F | F | F | F | F | F | F | F | E | E | E | E | E | E | E | |
| 0.100 104 | | | | | | | F | F | F | F | F | F | F | F | F | F | F | F | F | F | F | E | E | E | E | E | E | E | |
| 0.150 154 | | | | | | | | | | | | | | | | | | | | | | G | G | G | G | G | G | G | |
| 0.220 224 | | | | | | | | | | | | | | | | | | | | | | G | G | G | G | G | G | G | |
| 0.270 274 | | | | | | | | | | | | | | | | | | | | | | | | | | | | | |
| 0.330 334 | | | | | | | | | | | | | | | | | | | | | | | | | | | | | |
| 0.390 394 | | | | | | | | | | | | | | | | | | | | | | | | | | | | | |
| 0.470 474 | | | | | | | | | | | | | | | | | | | | | | | | | | | | | |
| 0.560 564 | | | | | | | | | | | | | | | | | | | | | | | | | | | | | |
| 0.680 684 | | | | | | | | | | | | | | | | | | | | | | | | | | | | | |
| 0.820 824 | | | | | | | | | | | | | | | | | | | | | | | | | | | | | |
| 1.000 105 | | | | | | | | | | | | | | | | | | | | | | | | | | | | | |
| Voltage (V) | 600 | 630 | 1000 | 600 | 630 | 1000 | 1500 | 2000 | 600 | 630 | 1000 | 1500 | 2000 | 600 | 630 | 1000 | 1500 | 2000 | 2500 | 3000 | 4000 | 600 | 630 | 1000 | 1500 | 2000 | 2500 | 3000 | 4000 |
| Case Size | 0805 | | | | | | 1206 | | | | | 1210 | | | | | 1808 | | | | | | 1812 | | | | | | |

High Voltage MLC Chips

FLEXITERM[®] - 600V to 5000V Applications



X7R CAPACITANCE RANGE

PREFERRED SIZES ARE SHADED

| Case Size | 1825 | | | | | | | | 2220 | | | | | | | | 2225 | | | | | | | | 3640 | | | | | | | | | | | |
|---------------|------------------------------|------|------|------|------|------|------|------|------------------------------|------|------|------|------|------|------|------|--------------------------------|------|-----|------|------|------|------|------|--------------------------------|------|------|-----|------|------|------|------|------|------|------|------|
| Soldering | Reflow Only | | | | | | | | Reflow Only | | | | | | | | Reflow Only | | | | | | | | Reflow Only | | | | | | | | | | | |
| (L) Length | 4.60 0.50 (0.181 0.020) | | | | | | | | 5.70 0.50 (0.224 0.020) | | | | | | | | 5.72 ± 0.25 (0.225 ± 0.010) | | | | | | | | 9.14 ± 0.25 (0.360 ± 0.010) | | | | | | | | | | | |
| W) Width | 6.30 0.40 (0.248 ± 0.016) | | | | | | | | 5.00 0.40 (0.197 0.016) | | | | | | | | 6.35 ± 0.25 (0.250 ± 0.010) | | | | | | | | 5.72 ± 0.25 (0.225 ± 0.010) | | | | | | | | | | | |
| (T) Thickness | 3.40 (0.134) | | | | | | | | 3.40 (0.134) | | | | | | | | 2.54 (0.100) | | | | | | | | 2.54 (0.100) | | | | | | | | | | | |
| (t) Terminal | 0.75 0.35 (0.030 ± 0.014) | | | | | | | | 0.85 0.35 (0.033 ± 0.014) | | | | | | | | 0.85 ± 0.35 (0.033 ± 0.014) | | | | | | | | 0.76 (0.030) 1.52 (0.062) | | | | | | | | | | | |
| Voltage (V) | 600 | 630 | 1000 | 1500 | 2000 | 2500 | 3000 | 4000 | 600 | 630 | 1000 | 1500 | 2000 | 2500 | 3000 | 4000 | 5000 | 600 | 630 | 1000 | 1500 | 2000 | 2500 | 3000 | 4000 | 5000 | 600 | 630 | 1000 | 1500 | 2000 | 2500 | 3000 | 4000 | 5000 | |
| Cap (pF) | 100 | 101 | | | | | | | | | | | | | | | | | | | | | | | | | | | | | | | | | | |
| | 120 | 121 | | | | | | | | | | | | | | | | | | | | | | | | | | | | | | | | | | |
| | 150 | 151 | | | | | | | | | | | | | | | | | | | | | | | | | | | | | | | | | | |
| | 180 | 181 | | | | | | | | | | | | | | | | | | | | | | | | | | | | | | | | | | |
| | 220 | 221 | | | | | | | | | | | | | | | | | | | | | | | | | | | | | | | | | | |
| | 270 | 271 | | | | | | | | | | | | | | | | | | | | | | | | | | | | | | | | | | |
| | 330 | 331 | | | | | | | | | | | | | | | | | | | | | | | | | | | | | | | | | | |
| | 390 | 391 | | | | | | | | | | | | | | | | | | | | | | | | | | | | | | | | | | |
| | 470 | 471 | | | | | | | | | | | | | | | | | | | | | | | | | | | | | | | | | | |
| | 560 | 561 | | | | | | | | | | | | | | | | | | | | | | | | | | | | | | | | | | |
| | 680 | 681 | | | | | | | | | | | | | | | | | | | | | | | | | | | | | | | | | | |
| | 750 | 751 | | | | | | | | | | | | | | | | | | | | | | | | | | | | | | | | | | |
| | 820 | 821 | | | | | | | | | | | | | | | | | | | | | | | | | | | | | | | | | | |
| | 1000 | 102 | F | F | F | F | F | F | F | F | F | F | F | F | F | F | F | F | F | F | F | F | F | F | F | F | G | G | G | G | G | G | G | | | |
| | 1200 | 122 | F | F | F | F | F | F | F | F | F | F | F | F | F | F | F | F | F | F | F | F | F | F | F | F | F | G | G | G | G | G | G | | | |
| | 1500 | 152 | F | F | F | F | F | F | F | F | F | F | F | F | F | F | F | F | F | F | F | F | F | F | F | F | F | G | G | G | G | G | G | | | |
| | 1800 | 182 | F | F | F | F | F | F | F | F | F | F | F | F | F | F | F | F | F | F | F | F | F | F | F | F | F | G | G | G | G | G | G | | | |
| | 2200 | 222 | F | F | F | F | F | F | F | F | F | F | F | F | F | F | F | F | F | F | F | F | F | F | F | F | F | F | G | G | G | G | G | | | |
| | 2700 | 272 | F | F | F | F | F | F | F | F | F | F | F | F | F | F | F | F | F | F | F | F | F | F | F | F | F | F | G | G | G | G | G | | | |
| | 3300 | 332 | F | F | F | F | F | F | F | F | F | F | F | F | F | F | F | F | F | F | F | F | F | F | F | F | F | F | G | G | G | G | G | | | |
| | 3900 | 392 | F | F | F | F | F | F | F | F | F | F | F | F | F | F | F | F | F | F | F | F | F | F | F | F | F | F | G | G | G | G | G | | | |
| | 4700 | 472 | F | F | F | F | F | F | F | F | F | F | F | F | F | F | F | F | F | F | F | F | F | F | F | F | F | F | G | G | G | G | G | | | |
| | 5600 | 562 | F | F | F | F | F | F | F | F | F | F | F | F | F | F | F | F | F | F | F | F | F | F | F | F | F | F | G | G | G | G | G | | | |
| | 6800 | 682 | F | F | F | G | G | G | G | G | | | | | | | | | | | | | | | | | | | | | | | | | | |
| | 8200 | 822 | F | F | F | G | G | G | G | G | | | | | | | | | | | | | | | | | | | | | | | | | | |
| | Cap (µF) | 0010 | 103 | F | F | F | G | G | G | G | F | F | F | G | G | G | G | F | F | F | F | F | F | F | F | F | F | G | G | G | G | G | | | | |
| | | 0015 | 153 | F | F | F | G | G | G | G | F | F | F | G | G | G | G | F | F | F | G | G | G | G | G | G | G | F | F | F | F | F | F | | | |
| | | 0018 | 183 | F | F | F | G | G | G | | F | F | F | G | G | G | G | F | F | F | G | G | G | | | | | | | | | | | | | |
| | | 0022 | 223 | F | F | F | G | G | G | | F | F | F | G | G | G | | F | F | F | G | G | G | | | | | | | | | | | | | |
| | | 0027 | 273 | F | F | F | G | | | | F | F | F | G | G | G | | F | F | F | G | G | G | | | | | | | | | | | | | |
| | | 0033 | 333 | F | F | F | G | | | | F | F | F | G | | | | F | F | F | G | G | | | | | | | | | | | | | | |
| | | 0039 | 393 | F | F | F | G | | | | F | F | F | G | | | | F | F | F | G | | | | | | | | | | | | | | | |
| | | 0047 | 473 | F | F | F | P | | | | F | F | F | G | | | | F | F | F | G | | | | | | | | | | | | | | | |
| | | 0056 | 563 | F | F | F | G | | | | F | F | F | G | | | | F | F | F | G | | | | | | | | | | | | | | | |
| | | 0068 | 683 | F | F | G | | | | | F | F | G | | | | | F | F | F | G | | | | | | | | | | | | | | | |
| | | 0082 | 823 | F | F | G | | | | | F | F | G | | | | | F | F | G | | | | | | | | | | | | | | | | |
| | | 0100 | 104 | F | F | G | | | | | F | F | G | | | | | F | F | G | | | | | | | | | | | | | | | | |
| | | 0150 | 154 | F | F | | | | | | F | F | G | | | | | F | F | G | | | | | | | | | | | | | | | | |
| | | 0220 | 224 | F | F | | | | | | F | F | G | | | | | F | F | | | | | | | | | | | | | | | | | |
| | | 0270 | 274 | F | F | | | | | | F | F | | | | | | F | F | | | | | | | | | | | | | | | | | |
| | | 0330 | 334 | F | F | | | | | | F | F | | | | | | F | F | | | | | | | | | | | | | | | | | |
| | | 0390 | 394 | F | F | | | | | | F | F | | | | | | F | F | | | | | | | | | | | | | | | | | |
| | | 0470 | 474 | F | F | | | | | | F | F | | | | | | F | F | | | | | | | | | | | | | | | | | |
| | | 0560 | 564 | G | G | | | | | | G | G | | | | | | F | F | | | | | | | | | | | | | | | | | |
| | | 0680 | 684 | | | | | | | | G | G | | | | | | G | G | | | | | | | | | | | | | | | | | |
| | | 0820 | 824 | | | | | | | | G | G | | | | | | G | G | | | | | | | | | | | | | | | | | |
| | | 1000 | 105 | | | | | | | | G | G | | | | | | G | G | | | | | | | | | | | | | | | | | |
| | Voltage (V) | 600 | 630 | 1000 | 1500 | 2000 | 2500 | 3000 | 4000 | 600 | 630 | 1000 | 1500 | 2000 | 2500 | 3000 | 4000 | 5000 | 600 | 630 | 1000 | 1500 | 2000 | 2500 | 3000 | 4000 | 5000 | 600 | 630 | 1000 | 1500 | 2000 | 2500 | 3000 | 4000 | 5000 |
| | Case Size | 1825 | | | | | | | | 2220 | | | | | | | | 2225 | | | | | | | | 3640 | | | | | | | | | | |

| Letter | A | C | E | F | G | P | X |
|-----------------------|------------------|------------------|-------------------|-------------------|------------------|------------------|------------------|
| Max. Thickness | 0.813 (0.032) | 1.448 (0.057) | 1.8034 (0.071) | 2.2098 (0.087) | 2.794 (0.110) | 3.048 (0.120) | 0.940 (0.037) |

NOTE: Contact factory for non-specified capacitance values

High Voltage MLC Chip Capacitors

For 600V to 3000V Automotive Applications - AEC-Q200

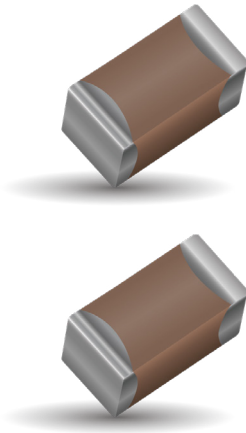

Modern automotive electronics could require components capable to work with high voltage (e.g. xenon lamp circuits or power converters in hybrid cards). AVX offers high voltage ceramic capacitors qualified according to AEC-Q200 standard.

High value, low leakage and small size are difficult parameters to obtain in capacitors for high voltage systems. AVX special high voltage MLC chip capacitors meet these performance characteristics and are designed for applications such as snubbers in high frequency power converters, resonators in SMPS, and high voltage coupling/dc blocking. These high voltage chip designs exhibit low ESRs at high frequencies.

Due to high voltage nature, larger physical dimensions are necessary. These larger sizes require special precautions to be taken in applying of MLC chips. The temperature gradient during heating or cooling cycles should not exceed 4°C per second. The preheat temperature must be within 50°C of the peak temperature reached by the ceramic bodies through the soldering process. Chip sizes 1210 and larger should be reflow soldered only. Capacitors may require protective surface coating to prevent external arcing.

To improve mechanical and thermal resistance, AVX recommend to use flexible terminations system - FLEXITERM®.

HOW TO ORDER

| 1210 | C | C | 223 | K | 4 | T | 1 | A |
|--------------------------------------|---|-------------------|---|------------------------------|---------------------|--|---------------------------------------|---------------------|
| Size | Voltage | Dielectric | Capacitance Code | Capacitance Tolerance | Failure Rate | Terminations | Packaging | Special Code |
| 1206 1210 1808 1812 2220 | C = 630V A = 1000V S = 1500V G = 2000V W = 2500V H = 3000V | X7R = C | 2 Sig. Digits + Number of Zeros e.g. 103 = 10nF (223 = 22nF) | K = ±10% M = ±20% | 4=Automotive | T = Plated Ni and Sn Z = FLEXITERM® | 1 or 2 = 7" Reel 3 or 4 = 13" Reel | A = Std. Product |

*AVX offers nonstandard case size. Contact factory for details.

Notes: Capacitors with X7R dielectrics are not intended for applications across AC supply mains or AC line filtering with polarity reversal. Please contact AVX for recommendations

CHIP DIMENSIONS DESCRIPTION

(See capacitance range chart on page 128)

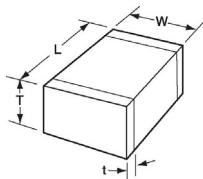

L = Length
W = Width
T = Thickness
t = Terminal

X7R DIELECTRIC PERFORMANCE CHARACTERISTICS

| Parameter/Test | Specification Limits | Measuring Conditions |
|------------------------------------|--|--|
| Operating Temperature Range | -55°C to +125°C | Temperature Cycle Chamber |
| Capacitance | within specified tolerance | Freq.: 1kHz ±10% |
| Dissipation Factor | 2.5% max. | Voltage: 1.0Vrms ±0.2Vrms |
| Capacitance Tolerance | ±5% (J), ±10% (K), ±20% (M) | T = +25°C, V = 0Vdc |
| Temperature Characteristics | X7R = ±15% | Vdc = 0V, T = (-55°C to +125°C) |
| Insulation Resistance | 100GΩ min. or 1000MΩ · μF min. (whichever is less) 10GΩ min. or 100MΩ · μF min. (whichever is less) | T = +25°C, V = 500Vdc T = +125°C, V = 500Vdc (t ≥ 120 sec, I ≤ 50mA) |
| Dielectric Strength | No breakdown or visual defect | 120% of rated voltage t ≤ 5 sec, I ≤ 50mA |

High Voltage MLC Chips FLEXITERM®

For 600V to 3000V Automotive Applications - AEC-Q200



X7R CAPACITANCE RANGE

PREFERRED SIZES ARE SHADED

| Case Size | | 1206 | | | | | 1210 | | | | 1808 | | | | | 1812 | | | | | 2220 | | | | | | | |
|---------------|-------|-----------------|------|------|------|------|---------------|------|------|------|-----------------|------|------|------|------|-----------------|-----|------|------|------|-----------------|------|------|-----|------|------|------|------|
| Soldering | | Reflow/Wave | | | | | ReflowOnly | | | | ReflowOnly | | | | | ReflowOnly | | | | | ReflowOnly | | | | | | | |
| (L) Length | mm | 3.20 ± 0.20 | | | | | 3.30 ± 0.40 | | | | 4.57 ± 0.25 | | | | | 4.50 ± 0.30 | | | | | 5.70 ± 0.50 | | | | | | | |
| | (in.) | (0.126 ± 0.008) | | | | | 0.130 ± 0.016 | | | | (0.180 ± 0.010) | | | | | (0.177 ± 0.012) | | | | | (0.224 ± 0.020) | | | | | | | |
| (W) Width | mm | 1.60 ± 0.20 | | | | | 2.50 ± 0.30 | | | | 2.03 ± 0.25 | | | | | 3.20 ± 0.20 | | | | | 5.00 ± 0.40 | | | | | | | |
| | (in.) | (0.063 ± 0.008) | | | | | 0.098 ± 0.012 | | | | (0.080 ± 0.010) | | | | | (0.126 ± 0.008) | | | | | (0.197 ± 0.016) | | | | | | | |
| (T) Thickness | mm | 1.52 | | | | | 1.70 | | | | 2.03 | | | | | 2.54 | | | | | 3.30 | | | | | | | |
| | (in.) | (0.060) | | | | | (0.067) | | | | (0.080) | | | | | (0.100) | | | | | (0.130) | | | | | | | |
| (t) Terminal | mm | 0.25 (0.010) | | | | | 0.25 (0.010) | | | | 0.25 (0.010) | | | | | 0.25 (0.010) | | | | | 0.25 (0.010) | | | | | | | |
| | max | 0.75 (0.030) | | | | | 0.75 (0.030) | | | | 1.02 (0.040) | | | | | 1.02 (0.040) | | | | | 1.02 (0.040) | | | | | | | |
| Voltage (V) | | 630 | 1000 | 1500 | 2000 | 2500 | 630 | 1000 | 1500 | 2000 | 630 | 1000 | 1500 | 2000 | 2500 | 3000 | 630 | 1000 | 1500 | 2000 | 2500 | 3000 | 4000 | 630 | 1000 | 1500 | 2000 | 3000 |
| Cap (pF) | 100 | 101 | | | | | | | | | | | | | | | | | | | | | | | | | | |
| | 120 | 121 | | | | | | | | | | | | | | | | | | | | | | | | | | |
| | 150 | 151 | | | | | | | | | | | | | | | | | | | | | | | | | | |
| | 180 | 181 | | | | | | | | | | | | | | | | | | | | | | | | | | |
| | 220 | 221 | | | | | | | | | | | | | | | | | | | | | | | | | | |
| | 270 | 271 | | | | | | | | | | | | | | | | | | | | | | | | | | |
| | 330 | 331 | | | | | | | | | | | | | | | | | | | | | | | | | | |
| | 390 | 391 | | | | | | | | | | | | | | | | | | | | | | | | | | |
| | 470 | 471 | | | | | | | | | | | | | | | | | | | | | | | | | | |
| | 560 | 561 | | | | | | | | | | | | | | | | | | | | | | | | | | |
| | 680 | 681 | | | | | | | | | | | | | | | | | | | | | | | | | | |
| | 820 | 821 | | | | | | | | | | | | | | | | | | | | | | | | | | |
| | 1000 | 102 | | | | | | | | | | | | | | | | | | | | | | | | | | |
| | 1200 | 122 | | | | | | | | | | | | | | | | | | | | | | | | | | |
| | 1500 | 152 | | | | | | | | | | | | | | | | | | | | | | | | | | |
| | 1800 | 182 | | | | | | | | | | | | | | | | | | | | | | | | | | |
| | 2200 | 222 | | | | | | | | | | | | | | | | | | | | | | | | | | |
| 2700 | 272 | | | | | | | | | | | | | | | | | | | | | | | | | | | |
| 3300 | 332 | | | | | | | | | | | | | | | | | | | | | | | | | | | |
| 3900 | 392 | | | | | | | | | | | | | | | | | | | | | | | | | | | |
| 4700 | 472 | | | | | | | | | | | | | | | | | | | | | | | | | | | |
| 5600 | 562 | | | | | | | | | | | | | | | | | | | | | | | | | | | |
| 6800 | 682 | | | | | | | | | | | | | | | | | | | | | | | | | | | |
| 8200 | 822 | | | | | | | | | | | | | | | | | | | | | | | | | | | |
| Cap (µF) | 0.01 | 103 | | | | | | | | | | | | | | | | | | | | | | | | | | |
| | 0.012 | 123 | | | | | | | | | | | | | | | | | | | | | | | | | | |
| | 0.015 | 153 | | | | | | | | | | | | | | | | | | | | | | | | | | |
| | 0.018 | 183 | | | | | | | | | | | | | | | | | | | | | | | | | | |
| | 0.022 | 223 | | | | | | | | | | | | | | | | | | | | | | | | | | |
| | 0.027 | 273 | | | | | | | | | | | | | | | | | | | | | | | | | | |
| | 0.033 | 333 | | | | | | | | | | | | | | | | | | | | | | | | | | |
| | 0.039 | 393 | | | | | | | | | | | | | | | | | | | | | | | | | | |
| | 0.047 | 473 | | | | | | | | | | | | | | | | | | | | | | | | | | |
| | 0.056 | 563 | | | | | | | | | | | | | | | | | | | | | | | | | | |
| | 0.068 | 683 | | | | | | | | | | | | | | | | | | | | | | | | | | |
| | 0.082 | 823 | | | | | | | | | | | | | | | | | | | | | | | | | | |
| 0.100 | 104 | | | | | | | | | | | | | | | | | | | | | | | | | | | |
| 0.120 | 124 | | | | | | | | | | | | | | | | | | | | | | | | | | | |
| 0.150 | 154 | | | | | | | | | | | | | | | | | | | | | | | | | | | |
| Voltage (V) | | 630 | 1000 | 1500 | 2000 | 2500 | 630 | 1000 | 1500 | 2000 | 630 | 1000 | 1500 | 2000 | 2500 | 3000 | 630 | 1000 | 1500 | 2000 | 2500 | 3000 | 4000 | 630 | 1000 | 1500 | 2000 | 3000 |
| Case Size | | 1206 | | | | | 1210 | | | | 1808 | | | | | 1812 | | | | | 2220 | | | | | | | |

NOTE: Contact factory for non-specified capacitance values

MIL-PRF-55681/Chips

Part Number Example CDR01 thru CDR06



MILITARY DESIGNATION PER MIL-PRF-55681

Part Number Example

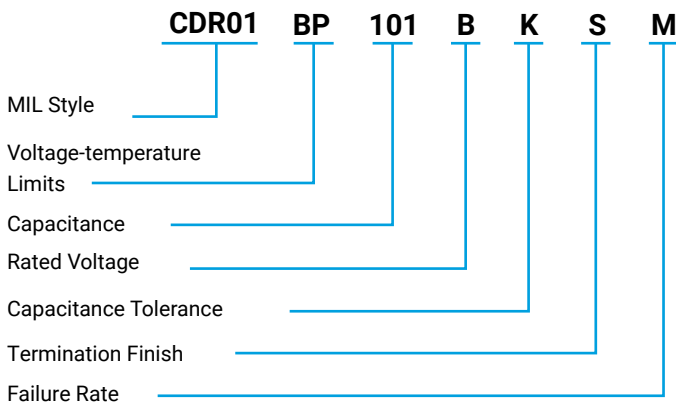

NOTE: Contact factory for availability of Termination and Tolerance Options for Specific Part Numbers.

MIL Style: CDR01, CDR02, CDR03, CDR04, CDR05, CDR06

Voltage Temperature Limits:

BP = 0 ± 30 ppm/°C without voltage; 0 ± 30 ppm/°C with rated voltage from -55°C to +125°C

BX = $\pm 15\%$ without voltage; +15 -25% with rated voltage from -55°C to +125°C

Capacitance: Two digit figures followed by multiplier (number of zeros to be added) e.g., 101 = 100 pF

Rated Voltage: A = 50V, B = 100V

Capacitance Tolerance: J $\pm 5\%$, K $\pm 10\%$, M $\pm 20\%$

Termination Finish:

- M = Palladium silver
- N = Silver-nickel-gold
- S = Solder coated final with a minimum of 4 percent lead
- T = Silver
- U = Base metallization-barrier metal-solder coated (tin/lead alloy, with a minimum of 4 percent lead)
- W = Base metallization-barrier metal-tinned (tin or tin/lead alloy)
- Y = Base metallization-barrier metal-tin (100 percent)
- Z = Base metallization-barrier metal-tinned (tin/lead alloy, with a minimum of 4 percent lead)

*See MIL-PRF-55681 Specification for more details

Failure Rate Level: M = 1.0%, P = .1%, R = .01%, S = .001%

Packaging: Bulk is standard packaging. Tape and reel per RS481 is available upon request.

***Not RoHS Compliant**

CROSS REFERENCE: AVX/MIL-PRF-55681/CDR01 THRU CDR06*

| Per MIL-PRF-55681 | AVX Style | Length (L) | Width (W) | Thickness (T) | | D | | Termination Band (t) | |
|-------------------|-----------|--------------------------------|--------------------------------|---------------|------|------|------|----------------------|------|
| | | | | Min. | Max. | Min. | Max. | Min. | Max. |
| CDR01 | 0805 | .080 ± .015 | .050 ± .015 | .022 | .055 | .030 | — | .010 | — |
| CDR02 | 1805 | .180 ± .015 | .050 ± .015 | .022 | .055 | — | — | .010 | .030 |
| CDR03 | 1808 | .180 ± .015 | .080 ± .018 | .022 | .080 | — | — | .010 | .030 |
| CDR04 | 1812 | .180 ± .015 | .125 ± .015 | .022 | .080 | — | — | .010 | .030 |
| CDR05 | 1825 | .180 ^{+.020} -.015 | .250 ^{+.020} -.015 | .020 | .080 | — | — | .010 | .030 |
| CDR06 | 2225 | .225 ± .020 | .250 ± .020 | .020 | .080 | — | — | .010 | .030 |

*For CDR11, 12, 13, and 14 see AVX Microwave Chip Capacitor Catalog

CDR01 thru CDR06 to MIL-PRF-55681

| Military Type Designation | Capacitance in pF | Capacitance tolerance | Rated temperature and voltage-temperature limits | WVDC |
|-----------------------------|-------------------|-----------------------|--|------|
| AVX Style 0805/CDR01 | | | | |
| CDR01BP100B-- | 10 | J,K | BP | 100 |
| CDR01BP120B-- | 12 | J | BP | 100 |
| CDR01BP150B-- | 15 | J,K | BP | 100 |
| CDR01BP180B-- | 18 | J | BP | 100 |
| CDR01BP220B-- | 22 | J,K | BP | 100 |
| CDR01BP270B-- | 27 | J | BP | 100 |
| CDR01BP330B-- | 33 | J,K | BP | 100 |
| CDR01BP390B-- | 39 | J | BP | 100 |
| CDR01BP470B-- | 47 | J,K | BP | 100 |
| CDR01BP560B-- | 56 | J | BP | 100 |
| CDR01BP680B-- | 68 | J,K | BP | 100 |
| CDR01BP820B-- | 82 | J | BP | 100 |
| CDR01BP101B-- | 100 | J,K | BP | 100 |
| CDR01B--121B-- | 120 | J,K | BP,BX | 100 |
| CDR01B--151B-- | 150 | J,K | BP,BX | 100 |
| CDR01B--181B-- | 180 | J,K | BP,BX | 100 |
| CDR01BX221B-- | 220 | K,M | BX | 100 |
| CDR01BX271B-- | 270 | K | BX | 100 |
| CDR01BX331B-- | 330 | K,M | BX | 100 |
| CDR01BX391B-- | 390 | K | BX | 100 |
| CDR01BX471B-- | 470 | K,M | BX | 100 |
| CDR01BX561B-- | 560 | K | BX | 100 |
| CDR01BX681B-- | 680 | K,M | BX | 100 |
| CDR01BX821B-- | 820 | K | BX | 100 |
| CDR01BX102B-- | 1000 | K,M | BX | 100 |
| CDR01BX122B-- | 1200 | K | BX | 100 |
| CDR01BX152B-- | 1500 | K,M | BX | 100 |
| CDR01BX182B-- | 1800 | K | BX | 100 |
| CDR01BX222B-- | 2200 | K,M | BX | 100 |
| CDR01BX272B-- | 2700 | K | BX | 100 |
| CDR01BX332B-- | 3300 | K,M | BX | 100 |
| CDR01BX392A-- | 3900 | K | BX | 50 |
| CDR01BX472A-- | 4700 | K,M | BX | 50 |
| AVX Style 1805/CDR02 | | | | |
| CDR02BP221B-- | 220 | J,K | BP | 100 |
| CDR02BP271B-- | 270 | J | BP | 100 |
| CDR02BX392B-- | 3900 | K | BX | 100 |
| CDR02BX472B-- | 4700 | K,M | BX | 100 |
| CDR02BX562B-- | 5600 | K | BX | 100 |
| CDR02BX682B-- | 6800 | K,M | BX | 100 |
| CDR02BX822B-- | 8200 | K | BX | 100 |
| CDR02BX103B-- | 10,000 | K,M | BX | 100 |
| CDR02BX123A-- | 12,000 | K | BX | 50 |
| CDR02BX153A-- | 15,000 | K,M | BX | 50 |
| CDR02BX183A-- | 18,000 | K | BX | 50 |
| CDR02BX223A-- | 22,000 | K,M | BX | 50 |

- Add appropriate failure rate
- Add appropriate termination finish
- Capacitance Tolerance

| Military Type Designation/ | Capacitance in pF | Capacitance tolerance | Rated temperature and voltage-temperature limits | WVDC |
|-----------------------------|-------------------|-----------------------|--|------|
| AVX Style 1808/CDR03 | | | | |
| CDR03BP331B-- | 330 | J,K | BP | 100 |
| CDR03BP391B-- | 390 | J | BP | 100 |
| CDR03BP471B-- | 470 | J,K | BP | 100 |
| CDR03BP561B-- | 560 | J | BP | 100 |
| CDR03BP681B-- | 680 | J,K | BP | 100 |
| CDR03BP821B-- | 820 | J | BP | 100 |
| CDR03BP102B-- | 1000 | J,K | BP | 100 |
| CDR03BX123B-- | 12,000 | K | BX | 100 |
| CDR03BX153B-- | 15,000 | K,M | BX | 100 |
| CDR03BX183B-- | 18,000 | K | BX | 100 |
| CDR03BX223B-- | 22,000 | K,M | BX | 100 |
| CDR03BX273B-- | 27,000 | K | BX | 100 |
| CDR03BX333B-- | 33,000 | K,M | BX | 100 |
| CDR03BX393A-- | 39,000 | K | BX | 50 |
| CDR03BX473A-- | 47,000 | K,M | BX | 50 |
| CDR03BX563A-- | 56,000 | K | BX | 50 |
| CDR03BX683A-- | 68,000 | K,M | BX | 50 |
| AVX Style 1812/CDR04 | | | | |
| CDR04BP122B-- | 1200 | J | BP | 100 |
| CDR04BP152B-- | 1500 | J,K | BP | 100 |
| CDR04BP182B-- | 1800 | J | BP | 100 |
| CDR04BP222B-- | 2200 | J,K | BP | 100 |
| CDR04BP272B-- | 2700 | J | BP | 100 |
| CDR04BP332B-- | 3300 | J,K | BP | 100 |
| CDR04BX393B-- | 39,000 | K | BX | 100 |
| CDR04BX473B-- | 47,000 | K,M | BX | 100 |
| CDR04BX563B-- | 56,000 | K | BX | 100 |
| CDR04BX823A-- | 82,000 | K | BX | 50 |
| CDR04BX104A-- | 100,000 | K,M | BX | 50 |
| CDR04BX124A-- | 120,000 | K | BX | 50 |
| CDR04BX154A-- | 150,000 | K,M | BX | 50 |
| CDR04BX184A-- | 180,000 | K | BX | 50 |
| AVX Style 1825/CDR05 | | | | |
| CDR05BP392B-- | 3900 | J,K | BP | 100 |
| CDR05BP472B-- | 4700 | J,K | BP | 100 |
| CDR05BP562B-- | 5600 | J,K | BP | 100 |
| CDR05BX683B-- | 68,000 | K,M | BX | 100 |
| CDR05BX823B-- | 82,000 | K | BX | 100 |
| CDR05BX104B-- | 100,000 | K,M | BX | 100 |
| CDR05BX124B-- | 120,000 | K | BX | 100 |
| CDR05BX154B-- | 150,000 | K,M | BX | 100 |
| CDR05BX224A-- | 220,000 | K,M | BX | 50 |
| CDR05BX274A-- | 270,000 | K | BX | 50 |
| CDR05BX334A-- | 330,000 | K,M | BX | 50 |
| AVX Style 2225/CDR06 | | | | |
| CDR06BP682B-- | 6800 | J,K | BP | 100 |
| CDR06BP822B-- | 8200 | J,K | BP | 100 |
| CDR06BP103B-- | 10,000 | J,K | BP | 100 |
| CDR06BX394A-- | 390,000 | K | BX | 50 |
| CDR06BX474A-- | 470,000 | K,M | BX | 50 |

- Add appropriate failure rate
- Add appropriate termination finish
- Capacitance Tolerance

MIL-PRF-55681/Chips

Part Number Example
CDR31 thru CDR35

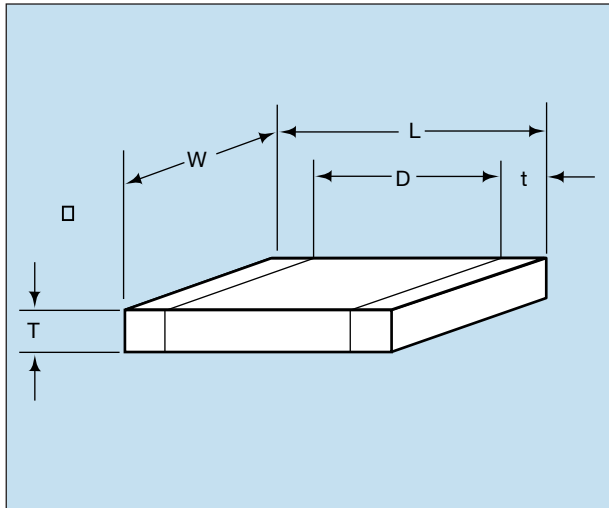

MILITARY DESIGNATION PER MIL-PRF-55681

Part Number Example

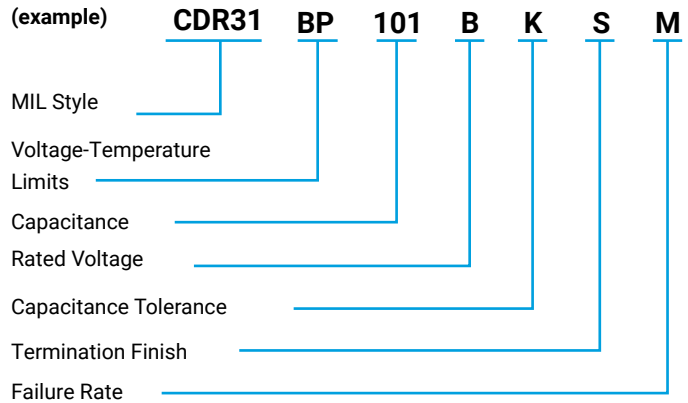

NOTE: Contact factory for availability of Termination and Tolerance Options for Specific Part Numbers.

MIL Style: CDR31, CDR32, CDR33, CDR34, CDR35

Voltage-Temperature Limits:

BP = 0 ± 30 ppm/°C without voltage; 0 ± 30 ppm/°C with rated voltage from -55°C to +125°C

BX = $\pm 15\%$ without voltage; +15 -25% with rated voltage from -55°C to +125°C

Capacitance: Two digit figures followed by multiplier (number of zeros to be added) e.g., 101 = 100 pF

Rated Voltage: A = 50V, B = 100V

Capacitance Tolerance: B $\pm .10$ pF, C $\pm .25$ pF, D $\pm .5$ pF, F $\pm 1\%$, J $\pm 5\%$, K $\pm 10\%$, M $\pm 20\%$

Termination Finish:

- M = Palladium silver
- N = Silver-nickel-gold
- S = Solder coated final with a minimum of 4 percent lead
- T = Silver
- U = Base metallization-barrier metal-solder coated (tin/lead alloy, with a minimum of 4 percent lead)
- W = Base metallization-barrier metal-tinned (tin or tin/lead alloy)
- Y = Base metallization-barrier metal-tin (100 percent)
- Z = Base metallization-barrier metal-tinned (tin/lead alloy, with a minimum of 4 percent lead)

*See MIL-PRF-55681 Specification for more details

Failure Rate Level: M = 1.0%, P = .1%, R = .01%, S = .001%

Packaging: Bulk is standard packaging. Tape and reel per RS481 is available upon request.

***Not RoHS Compliant**



CROSS REFERENCE: AVX/MIL-PRF-55681/CDR31 THRU CDR35

| Per MIL-PRF-55681 | AVX Style | Length (L) (mm) | Width (W) (mm) | Thickness (T) | | Termination Band (t) | |
|-------------------|-----------|-----------------|----------------|---------------|-----------|----------------------|-----------|
| | | | | Max. (mm) | Max. (mm) | Min. (mm) | Max. (mm) |
| CDR31 | 0805 | 2.00 | 1.25 | 1.3 | .50 | .70 | .30 |
| CDR32 | 1206 | 3.20 | 1.60 | 1.3 | — | .70 | .30 |
| CDR33 | 1210 | 3.20 | 2.50 | 1.5 | — | .70 | .30 |
| CDR34 | 1812 | 4.50 | 3.20 | 1.5 | — | .70 | .30 |
| CDR35 | 1825 | 4.50 | 6.40 | 1.5 | — | .70 | .30 |



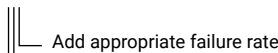
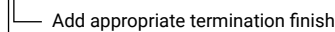

CDR31 to MIL-PRF-55681/7

| Military Type Designation 1 / | Capacitance in pF | Capacitance tolerance | Rated temperature and voltage-temperature limits | WVDC |
|----------------------------------|-------------------|-----------------------|--|------|
| AVX Style 0805/CDR31 (BP) | | | | |
| CDR31BP1R0B-- | 1.0 | B,C | BP | 100 |
| CDR31BP1R1B-- | 1.1 | B,C | BP | 100 |
| CDR31BP1R2B-- | 1.2 | B,C | BP | 100 |
| CDR31BP1R3B-- | 1.3 | B,C | BP | 100 |
| CDR31BP1R5B-- | 1.5 | B,C | BP | 100 |
| CDR31BP1R6B-- | 1.6 | B,C | BP | 100 |
| CDR31BP1R8B-- | 1.8 | B,C | BP | 100 |
| CDR31BP2R0B-- | 2.0 | B,C | BP | 100 |
| CDR31BP2R2B-- | 2.2 | B,C | BP | 100 |
| CDR31BP2R4B-- | 2.4 | B,C | BP | 100 |
| CDR31BP2R7B-- | 2.7 | B,C,D | BP | 100 |
| CDR31BP3R0B-- | 3.0 | B,C,D | BP | 100 |
| CDR31BP3R3B-- | 3.3 | B,C,D | BP | 100 |
| CDR31BP3R6B-- | 3.6 | B,C,D | BP | 100 |
| CDR31BP3R9B-- | 3.9 | B,C,D | BP | 100 |
| CDR31BP4R3B-- | 4.3 | B,C,D | BP | 100 |
| CDR31BP4R7B-- | 4.7 | B,C,D | BP | 100 |
| CDR31BP5R1B-- | 5.1 | B,C,D | BP | 100 |
| CDR31BP5R6B-- | 5.6 | B,C,D | BP | 100 |
| CDR31BP6R2B-- | 6.2 | B,C,D | BP | 100 |
| CDR31BP6R8B-- | 6.8 | B,C,D | BP | 100 |
| CDR31BP7R5B-- | 7.5 | B,C,D | BP | 100 |
| CDR31BP8R2B-- | 8.2 | B,C,D | BP | 100 |
| CDR31BP9R1B-- | 9.1 | B,C,D | BP | 100 |
| CDR31BP100B-- | 10 | F,J,K | BP | 100 |
| CDR31BP110B-- | 11 | F,J,K | BP | 100 |
| CDR31BP120B-- | 12 | F,J,K | BP | 100 |
| CDR31BP130B-- | 13 | F,J,K | BP | 100 |
| CDR31BP150B-- | 15 | F,J,K | BP | 100 |
| CDR31BP160B-- | 16 | F,J,K | BP | 100 |
| CDR31BP180B-- | 18 | F,J,K | BP | 100 |
| CDR31BP200B-- | 20 | F,J,K | BP | 100 |
| CDR31BP220B-- | 22 | F,J,K | BP | 100 |
| CDR31BP240B-- | 24 | F,J,K | BP | 100 |
| CDR31BP270B-- | 27 | F,J,K | BP | 100 |
| CDR31BP300B-- | 30 | F,J,K | BP | 100 |
| CDR31BP330B-- | 33 | F,J,K | BP | 100 |
| CDR31BP360B-- | 36 | F,J,K | BP | 100 |
| CDR31BP390B-- | 39 | F,J,K | BP | 100 |
| CDR31BP430B-- | 43 | F,J,K | BP | 100 |
| CDR31BP470B-- | 47 | F,J,K | BP | 100 |
| CDR31BP510B-- | 51 | F,J,K | BP | 100 |
| CDR31BP560B-- | 56 | F,J,K | BP | 100 |
| CDR31BP620B-- | 62 | F,J,K | BP | 100 |
| CDR31BP680B-- | 68 | F,J,K | BP | 100 |
| CDR31BP750B-- | 75 | F,J,K | BP | 100 |
| CDR31BP820B-- | 82 | F,J,K | BP | 100 |
| CDR31BP910B-- | 91 | F,J,K | BP | 100 |

 Add appropriate failure rate
 Add appropriate termination finish
 Capacitance Tolerance

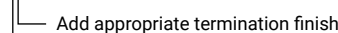
| Military Type Designation 1 / | Capacitance in pF | Capacitance tolerance | Rated temperature and voltage-temperature limits | WVDC |
|---|-------------------|-----------------------|--|------|
| AVX Style 0805/CDR31 (BP) cont'd | | | | |
| CDR31BP101B-- | 100 | F,J,K | BP | 100 |
| CDR31BP111B-- | 110 | F,J,K | BP | 100 |
| CDR31BP121B-- | 120 | F,J,K | BP | 100 |
| CDR31BP131B-- | 130 | F,J,K | BP | 100 |
| CDR31BP151B-- | 150 | F,J,K | BP | 100 |
| CDR31BP161B-- | 160 | F,J,K | BP | 100 |
| CDR31BP181B-- | 180 | F,J,K | BP | 100 |
| CDR31BP201B-- | 200 | F,J,K | BP | 100 |
| CDR31BP221B-- | 220 | F,J,K | BP | 100 |
| CDR31BP241B-- | 240 | F,J,K | BP | 100 |
| CDR31BP271B-- | 270 | F,J,K | BP | 100 |
| CDR31BP301B-- | 300 | F,J,K | BP | 100 |
| CDR31BP331B-- | 330 | F,J,K | BP | 100 |
| CDR31BP361B-- | 360 | F,J,K | BP | 100 |
| CDR31BP391B-- | 390 | F,J,K | BP | 100 |
| CDR31BP431B-- | 430 | F,J,K | BP | 100 |
| CDR31BP471B-- | 470 | F,J,K | BP | 100 |
| CDR31BP511A-- | 510 | F,J,K | BP | 50 |
| CDR31BP561A-- | 560 | F,J,K | BP | 50 |
| CDR31BP621A-- | 620 | F,J,K | BP | 50 |
| CDR31BP681A-- | 680 | F,J,K | BP | 50 |
| AVX Style 0805/CDR31 (BX) | | | | |
| CDR31BX471B-- | 470 | K,M | BX | 100 |
| CDR31BX561B-- | 560 | K,M | BX | 100 |
| CDR31BX681B-- | 680 | K,M | BX | 100 |
| CDR31BX821B-- | 820 | K,M | BX | 100 |
| CDR31BX102B-- | 1,000 | K,M | BX | 100 |
| CDR31BX122B-- | 1,200 | K,M | BX | 100 |
| CDR31BX152B-- | 1,500 | K,M | BX | 100 |
| CDR31BX182B-- | 1,800 | K,M | BX | 100 |
| CDR31BX222B-- | 2,200 | K,M | BX | 100 |
| CDR31BX272B-- | 2,700 | K,M | BX | 100 |
| CDR31BX332B-- | 3,300 | K,M | BX | 100 |
| CDR31BX392B-- | 3,900 | K,M | BX | 100 |
| CDR31BX472B-- | 4,700 | K,M | BX | 100 |
| CDR31BX562A-- | 5,600 | K,M | BX | 50 |
| CDR31BX682A-- | 6,800 | K,M | BX | 50 |
| CDR31BX822A-- | 8,200 | K,M | BX | 50 |
| CDR31BX103A-- | 10,000 | K,M | BX | 50 |
| CDR31BX123A-- | 12,000 | K,M | BX | 50 |
| CDR31BX153A-- | 15,000 | K,M | BX | 50 |
| CDR31BX183A-- | 18,000 | K,M | BX | 50 |

 Add appropriate failure rate
 Add appropriate termination finish
 Capacitance Tolerance

1/ The complete part number will include additional symbols to indicate capacitance tolerance, termination and failure rate level.

CDR32 to MIL-PRF-55681/8

| Military Type Designation 1 / | Capacitance in pF | Capacitance Tolerance | Rated temperature and Voltage-Temperature Limits | WVDC |
|----------------------------------|-------------------|-----------------------|--|------|
| AVX Style 1206/CDR32 (BP) | | | | |
| CDR32BP1R0B-- | 1.0 | B,C | BP | 100 |
| CDR32BP1R1B-- | 1.1 | B,C | BP | 100 |
| CDR32BP1R2B-- | 1.2 | B,C | BP | 100 |
| CDR32BP1R3B-- | 1.3 | B,C | BP | 100 |
| CDR32BP1R5B-- | 1.5 | B,C | BP | 100 |
| CDR32BP1R6B-- | 1.6 | B,C | BP | 100 |
| CDR32BP1R8B-- | 1.8 | B,C | BP | 100 |
| CDR32BP2R0B-- | 2.0 | B,C | BP | 100 |
| CDR32BP2R2B-- | 2.2 | B,C | BP | 100 |
| CDR32BP2R4B-- | 2.4 | B,C | BP | 100 |
| CDR32BP2R7B-- | 2.7 | B,C,D | BP | 100 |
| CDR32BP3R0B-- | 3.0 | B,C,D | BP | 100 |
| CDR32BP3R3B-- | 3.3 | B,C,D | BP | 100 |
| CDR32BP3R6B-- | 3.6 | B,C,D | BP | 100 |
| CDR32BP3R9B-- | 3.9 | B,C,D | BP | 100 |
| CDR32BP4R3B-- | 4.3 | B,C,D | BP | 100 |
| CDR32BP4R7B-- | 4.7 | B,C,D | BP | 100 |
| CDR32BP5R1B-- | 5.1 | B,C,D | BP | 100 |
| CDR32BP5R6B-- | 5.6 | B,C,D | BP | 100 |
| CDR32BP6R2B-- | 6.2 | B,C,D | BP | 100 |
| CDR32BP6R8B-- | 6.8 | B,C,D | BP | 100 |
| CDR32BP7R5B-- | 7.5 | B,C,D | BP | 100 |
| CDR32BP8R2B-- | 8.2 | B,C,D | BP | 100 |
| CDR32BP9R1B-- | 9.1 | B,C,D | BP | 100 |
| CDR32BP100B-- | 10 | F,J,K | BP | 100 |
| CDR32BP110B-- | 11 | F,J,K | BP | 100 |
| CDR32BP120B-- | 12 | F,J,K | BP | 100 |
| CDR32BP130B-- | 13 | F,J,K | BP | 100 |
| CDR32BP150B-- | 15 | F,J,K | BP | 100 |
| CDR32BP160B-- | 16 | F,J,K | BP | 100 |
| CDR32BP180B-- | 18 | F,J,K | BP | 100 |
| CDR32BP200B-- | 20 | F,J,K | BP | 100 |
| CDR32BP220B-- | 22 | F,J,K | BP | 100 |
| CDR32BP240B-- | 24 | F,J,K | BP | 100 |
| CDR32BP270B-- | 27 | F,J,K | BP | 100 |
| CDR32BP300B-- | 30 | F,J,K | BP | 100 |
| CDR32BP330B-- | 33 | F,J,K | BP | 100 |
| CDR32BP360B-- | 36 | F,J,K | BP | 100 |
| CDR32BP390B-- | 39 | F,J,K | BP | 100 |
| CDR32BP430B-- | 43 | F,J,K | BP | 100 |
| CDR32BP470B-- | 47 | F,J,K | BP | 100 |
| CDR32BP510B-- | 51 | F,J,K | BP | 100 |
| CDR32BP560B-- | 56 | F,J,K | BP | 100 |
| CDR32BP620B-- | 62 | F,J,K | BP | 100 |
| CDR32BP680B-- | 68 | F,J,K | BP | 100 |
| CDR32BP750B-- | 75 | F,J,K | BP | 100 |
| CDR32BP820B-- | 82 | F,J,K | BP | 100 |
| CDR32BP910B-- | 91 | F,J,K | BP | 100 |

- └─ Add appropriate failure rate
- └─ Add appropriate termination finish
- └─ Capacitance Tolerance

| Military Type Designation 1 / | Capacitance in pF | Capacitance Tolerance | Rated Temperature and Voltage-Temperature Limits | WVDC |
|---|-------------------|-----------------------|--|------|
| AVX Style 0805/CDR31 (BP) cont'd | | | | |
| CDR32BP101B-- | 100 | F,J,K | BP | 100 |
| CDR32BP111B-- | 110 | F,J,K | BP | 100 |
| CDR32BP121B-- | 120 | F,J,K | BP | 100 |
| CDR32BP131B-- | 130 | F,J,K | BP | 100 |
| CDR32BP151B-- | 150 | F,J,K | BP | 100 |
| CDR32BP161B-- | 160 | F,J,K | BP | 100 |
| CDR32BP181B-- | 180 | F,J,K | BP | 100 |
| CDR32BP201B-- | 200 | F,J,K | BP | 100 |
| CDR32BP221B-- | 220 | F,J,K | BP | 100 |
| CDR32BP241B-- | 240 | F,J,K | BP | 100 |
| CDR32BP271B-- | 270 | F,J,K | BP | 100 |
| CDR32BP301B-- | 300 | F,J,K | BP | 100 |
| CDR32BP331B-- | 330 | F,J,K | BP | 100 |
| CDR32BP361B-- | 360 | F,J,K | BP | 100 |
| CDR32BP391B-- | 390 | F,J,K | BP | 100 |
| CDR32BP431B-- | 430 | F,J,K | BP | 100 |
| CDR32BP471B-- | 470 | F,J,K | BP | 100 |
| CDR32BP511B-- | 510 | F,J,K | BP | 100 |
| CDR32BP561B-- | 560 | F,J,K | BP | 100 |
| CDR32BP621B-- | 620 | F,J,K | BP | 100 |
| CDR32BP681B-- | 680 | F,J,K | BP | 100 |
| CDR32BP751B-- | 750 | F,J,K | BP | 100 |
| CDR32BP821B-- | 820 | F,J,K | BP | 100 |
| CDR32BP911B-- | 910 | F,J,K | BP | 100 |
| CDR32BP102B-- | 1,000 | F,J,K | BP | 100 |
| CDR32BP112A-- | 1,100 | F,J,K | BP | 50 |
| CDR32BP122A-- | 1,200 | F,J,K | BP | 50 |
| CDR32BP132A-- | 1,300 | F,J,K | BP | 50 |
| CDR32BP152A-- | 1,500 | F,J,K | BP | 50 |
| CDR32BP162A-- | 1,600 | F,J,K | BP | 50 |
| CDR32BP182A-- | 1,800 | F,J,K | BP | 50 |
| CDR32BP202A-- | 2,000 | F,J,K | BP | 50 |
| CDR32BP222A-- | 2,200 | F,J,K | BP | 50 |
| AVX Style 1206/CDR32 (BX) | | | | |
| CDR32BX472B-- | 4,700 | K,M | BX | 100 |
| CDR32BX562B-- | 5,600 | K,M | BX | 100 |
| CDR32BX682B-- | 6,800 | K,M | BX | 100 |
| CDR32BX822B-- | 8,200 | K,M | BX | 100 |
| CDR32BX103B-- | 10,000 | K,M | BX | 100 |
| CDR32BX123B-- | 12,000 | K,M | BX | 100 |
| CDR32BX153B-- | 15,000 | K,M | BX | 100 |
| CDR32BX183A-- | 18,000 | K,M | BX | 50 |
| CDR32BX223A-- | 22,000 | K,M | BX | 50 |
| CDR32BX273A-- | 27,000 | K,M | BX | 50 |
| CDR32BX333A-- | 33,000 | K,M | BX | 50 |
| CDR32BX393A-- | 39,000 | K,M | BX | 50 |

- └─ Add appropriate failure rate
- └─ Add appropriate termination finish
- └─ Capacitance Tolerance

1/ The complete part number will include additional symbols to indicate capacitance tolerance, termination and failure rate level.

CDR33/34/35 to MIL-PRF-55681/9/10/11

| Military Type Designation 1 / | Capacitance in pF | Capacitance tolerance | Rated temperature and voltage-temperature limits | WVDC |
|----------------------------------|-------------------|-----------------------|--|------|
| AVX Style 1210/CDR33 (BP) | | | | |
| CDR33BP102B-- | 1,000 | F,J,K | BP | 100 |
| CDR33BP112B-- | 1,100 | F,J,K | BP | 100 |
| CDR33BP122B-- | 1,200 | F,J,K | BP | 100 |
| CDR33BP132B-- | 1,300 | F,J,K | BP | 100 |
| CDR33BP152B-- | 1,500 | F,J,K | BP | 100 |
| CDR33BP162B-- | 1,600 | F,J,K | BP | 100 |
| CDR33BP182B-- | 1,800 | F,J,K | BP | 100 |
| CDR33BP202B-- | 2,000 | F,J,K | BP | 100 |
| CDR33BP222B-- | 2,200 | F,J,K | BP | 100 |
| CDR33BP242A-- | 2,400 | F,J,K | BP | 50 |
| CDR33BP272A-- | 2,700 | F,J,K | BP | 50 |
| CDR33BP302A-- | 3,000 | F,J,K | BP | 50 |
| CDR33BP332A-- | 3,300 | F,J,K | BP | 50 |
| AVX Style 1210/CDR33 (BX) | | | | |
| CDR33BX153B-- | 15,000 | K,M | BX | 100 |
| CDR33BX183B-- | 18,000 | K,M | BX | 100 |
| CDR33BX223B-- | 22,000 | K,M | BX | 100 |
| CDR33BX273B-- | 27,000 | K,M | BX | 100 |
| CDR33BX393A-- | 39,000 | K,M | BX | 50 |
| CDR33BX473A-- | 47,000 | K,M | BX | 50 |
| CDR33BX563A-- | 56,000 | K,M | BX | 50 |
| CDR33BX683A-- | 68,000 | K,M | BX | 50 |
| CDR33BX823A-- | 82,000 | K,M | BX | 50 |
| CDR33BX104A-- | 100,000 | K,M | BX | 50 |
| AVX Style 1812/CDR34 (BP) | | | | |
| CDR34BP222B-- | 2,200 | F,J,K | BP | 100 |
| CDR34BP242B-- | 2,400 | F,J,K | BP | 100 |
| CDR34BP272B-- | 2,700 | F,J,K | BP | 100 |
| CDR34BP302B-- | 3,000 | F,J,K | BP | 100 |
| CDR34BP332B-- | 3,300 | F,J,K | BP | 100 |
| CDR34BP362B-- | 3,600 | F,J,K | BP | 100 |
| CDR34BP392B-- | 3,900 | F,J,K | BP | 100 |
| CDR34BP432B-- | 4,300 | F,J,K | BP | 100 |
| CDR34BP472B-- | 4,700 | F,J,K | BP | 100 |
| CDR34BP512A-- | 5,100 | F,J,K | BP | 50 |
| CDR34BP562A-- | 5,600 | F,J,K | BP | 50 |
| CDR34BP622A-- | 6,200 | F,J,K | BP | 50 |
| CDR34BP682A-- | 6,800 | F,J,K | BP | 50 |
| CDR34BP752A-- | 7,500 | F,J,K | BP | 50 |
| CDR34BP822A-- | 8,200 | F,J,K | BP | 50 |
| CDR34BP912A-- | 9,100 | F,J,K | BP | 50 |
| CDR34BP103A-- | 10,000 | F,J,K | BP | 50 |

- Add appropriate failure rate
- Add appropriate termination finish
- Capacitance Tolerance

| Military Type Designation 1 / | Capacitance in pF | Capacitance tolerance | Rated temperature and voltage-temperature limits | WVDC |
|----------------------------------|-------------------|-----------------------|--|------|
| AVX Style 1812/CDR34 (BX) | | | | |
| CDR34BX273B-- | 27,000 | K,M | BX | 100 |
| CDR34BX333B-- | 33,000 | K,M | BX | 100 |
| CDR34BX393B-- | 39,000 | K,M | BX | 100 |
| CDR34BX473B-- | 47,000 | K,M | BX | 100 |
| CDR34BX563B-- | 56,000 | K,M | BX | 100 |
| CDR34BX104A-- | 100,000 | K,M | BX | 50 |
| CDR34BX124A-- | 120,000 | K,M | BX | 50 |
| CDR34BX154A-- | 150,000 | K,M | BX | 50 |
| CDR34BX184A-- | 180,000 | K,M | BX | 50 |
| AVX Style 1825/CDR35 (BP) | | | | |
| CDR35BP472B-- | 4,700 | F,J,K | BP | 100 |
| CDR35BP512B-- | 5,100 | F,J,K | BP | 100 |
| CDR35BP562B-- | 5,600 | F,J,K | BP | 100 |
| CDR35BP622B-- | 6,200 | F,J,K | BP | 100 |
| CDR35BP682B-- | 6,800 | F,J,K | BP | 100 |
| CDR35BP752B-- | 7,500 | F,J,K | BP | 100 |
| CDR35BP822B-- | 8,200 | F,J,K | BP | 100 |
| CDR35BP912B-- | 9,100 | F,J,K | BP | 100 |
| CDR35BP103B-- | 10,000 | F,J,K | BP | 100 |
| CDR35BP113A-- | 11,000 | F,J,K | BP | 50 |
| CDR35BP123A-- | 12,000 | F,J,K | BP | 50 |
| CDR35BP133A-- | 13,000 | F,J,K | BP | 50 |
| CDR35BP153A-- | 15,000 | F,J,K | BP | 50 |
| CDR35BP163A-- | 16,000 | F,J,K | BP | 50 |
| CDR35BP183A-- | 18,000 | F,J,K | BP | 50 |
| CDR35BP203A-- | 20,000 | F,J,K | BP | 50 |
| CDR35BP223A-- | 22,000 | F,J,K | BP | 50 |
| AVX Style 1825/CDR35 (BX) | | | | |
| CDR35BX563B-- | 56,000 | K,M | BX | 100 |
| CDR35BX683B-- | 68,000 | K,M | BX | 100 |
| CDR35BX823B-- | 82,000 | K,M | BX | 100 |
| CDR35BX104B-- | 100,000 | K,M | BX | 100 |
| CDR35BX124B-- | 120,000 | K,M | BX | 100 |
| CDR35BX154B-- | 150,000 | K,M | BX | 100 |
| CDR35BX184A-- | 180,000 | K,M | BX | 50 |
| CDR35BX224A-- | 220,000 | K,M | BX | 50 |
| CDR35BX274A-- | 270,000 | K,M | BX | 50 |
| CDR35BX334A-- | 330,000 | K,M | BX | 50 |
| CDR35BX394A-- | 390,000 | K,M | BX | 50 |
| CDR35BX474A-- | 470,000 | K,M | BX | 50 |

- Add appropriate failure rate
- Add appropriate termination finish
- Capacitance Tolerance

1/ The complete part number will include additional symbols to indicate capacitance tolerance, termination and failure rate level.

MLCC Medical Applications – MM Series

General Specifications

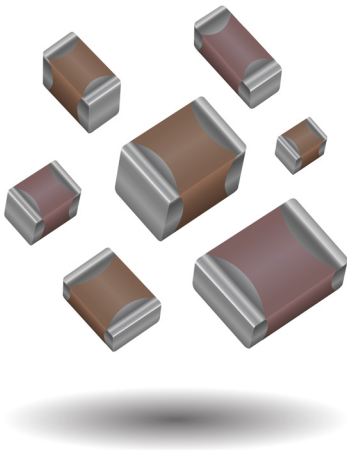

The AVX MM series is a multi-layer ceramic capacitor designed for use in medical applications other than implantable/life support. These components have the design & change control expected for medical devices and also offer enhanced LAT including reliability testing and 100% inspection.

APPLICATIONS

Implantable, Non-Life Supporting Medical Devices

- e.g. implanted temporary cardiac monitor, insulin pumps

External, Life Supporting Medical Devices

- e.g. heart pump external controller

External Devices

- e.g. patient monitoring, diagnostic equipment

HOW TO ORDER

| | | | | | | | | |
|--|--|--------------------------|---|--|---|---|-----------------------------|--|
| MM02 | Z | A | 100 | J | G | T | 3 | A |
| Size | Rated Voltage | Dielectric Code | Capacitance Code (In pF) (2 significant digits + number of zeros) | Capacitance Tolerance | Failure Rate C = Standard Range Contact AVX for others | Termination Finish | Packaging | Special Code |
| MM02 = 0402 MM03 = 0603 MM05 = 0805 MM06 = 1206 MM10 = 1210 MM08 = 1808 MM12 = 1812 MM20 = 2220 | Z = 10V Y = 16V 3 = 25V 5 = 50V 1 = 100V 2 = 200V V = 250V 7 = 500V | A = NP0 (COG) C = X7R | for values <10pF: letter R denotes decimal point. Example: 68pF = 680 8.2pF = 8R2 | B = ±0.1pF C = ±0.25pF D = ±0.5pF F = ±1% (≥10pF) G = ±2% (≥10pF) J = ±5% K = ±10% M = ±20% | | T = Plated Ni & Sn (NP0 only) Z = Flexiterm (X7R only) | 2 = 7" Reel 4 = 13" Reel | A = Standard Contact AVX for others |

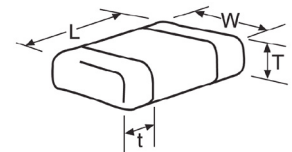

COMMERCIAL VS MM SERIES PROCESS COMPARISON

| | Commercial | MM Series |
|--|--|--|
| Administrative | Standard part numbers; no restriction on who purchases these parts | Specific series part number, used to control supply of product |
| Design | Minimum ceramic thickness of 0.020" on all X7R product | Minimum ceramic thickness of 0.029" (0.74mm) |
| Dicing | Side & end margins = 0.003" min | Side & end margins = 0.004" min Cover layers = 0.003" min |
| Lot Qualification Destructive Physical Analysis (DPA) | As per EIA RS469 | Increased sample plan – stricter criteria |
| Visual/Cosmetic Quality | Standard process and inspection | 100% inspection |
| Application Robustness | Standard sampling for accelerated wave solder on X7R dielectrics | Increased sampling for accelerated wave solder on X7R and NP0 followed by lot by lot reliability testing |
| Design/Change Control | Required to inform customer of changes in: <ul style="list-style-type: none"> • form • fit • function | AVX will qualify and notify customers before making any change to the following materials or processes: <ul style="list-style-type: none"> • Dielectric formulation, type, or supplier • Metal formulation, type, or supplier • Termination material formulation, type, or supplier • Manufacturing equipment type • Quality testing regime including sample size and accept/ reject criteria |

MM Series – MLCC for Medical Applications

NP0 (COG) – Specifications & Test Methods

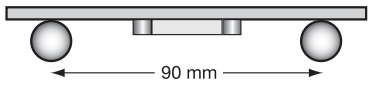
| Parameter/Test | | NP0 Specification Limits | Measuring Conditions | |
|---------------------------------------|-----------------------|---|---|----------------|
| Operating Temperature Range | | -55°C to +125°C | Temperature Cycle Chamber | |
| Capacitance | | Within specified tolerance | Freq.: 1.0 MHz ± 10% for cap ≤ 1000 pF 1.0 kHz ± 10% for cap > 1000 pF Voltage: 1.0Vrms ± .2V | |
| Q | | <30 pF: Q ≥ 400+20 x Cap Value ≥30 pF: Q ≥ 1000 | | |
| Insulation Resistance | | 100,000MΩ or 1000MΩ - μF, whichever is less | Charge device with rated voltage for 60 ± 5 secs @ room temp/humidity | |
| Dielectric Strength | | No breakdown or visual defects | Charge device with 300% of rated voltage for 1-5 seconds, w/charge and discharge current limited to 50 mA (max) Note: Charge device with 150% of rated voltage for 500V devices. | |
| Resistance to Flexure Stresses | Appearance | No defects | Deflection: 2mm Test Time: 30 seconds 1mm/sec  | |
| | Capacitance Variation | ±5% or ±.5 pF, whichever is greater | | |
| | Q | Meets Initial Values (As Above) | | |
| | Insulation Resistance | ≥ Initial Value x 0.3 | | |
| Solderability | | ≥ 95% of each terminal should be covered with fresh solder | Dip device in eutectic solder at 230 ± 5°C for 5.0 ± 0.5 seconds | |
| Resistance to Solder Heat | Appearance | No defects, <25% leaching of either end terminal | Dip device in eutectic solder at 260°C for 60 seconds. Store at room temperature for 24 ± 2 hours before measuring electrical properties. | |
| | Capacitance Variation | ≤ ±2.5% or ±.25 pF, whichever is greater | | |
| | Q | Meets Initial Values (As Above) | | |
| | Insulation Resistance | Meets Initial Values (As Above) | | |
| Thermal Shock | Appearance | No visual defects | Step 1: -55°C ± 2° | 30 ± 3 minutes |
| | Capacitance Variation | ≤ ±2.5% or ±.25 pF, whichever is greater | Step 2: Room Temp | ≤ 3 minutes |
| | Q | Meets Initial Values (As Above) | Step 3: +125°C ± 2° | 30 ± 3 minutes |
| | Insulation Resistance | Meets Initial Values (As Above) | Step 4: Room Temp | ≤ 3 minutes |
| | Dielectric Strength | Meets Initial Values (As Above) | Repeat for 5 cycles and measure after 24 hours at room temperature | |
| Load Life | Appearance | No visual defects | Charge device with twice rated voltage in test chamber set at 125°C ± 2°C for 1000 hours (+48, -0). Remove from test chamber and stabilize at room temperature for 24 hours before measuring. | |
| | Capacitance Variation | ≤ ±3.0% or ± .3 pF, whichever is greater | | |
| | Q | ≥ 30 pF: Q ≥ 350 ≥10 pF, <30 pF: Q ≥ 275 +5C/2 <10 pF: Q ≥ 200 +10C | | |
| | Insulation Resistance | ≥ Initial Value x 0.3 (See Above) | | |
| Load Humidity | Appearance | No visual defects | Store in a test chamber set at 85°C ± 2°C/ 85% ± 5% relative humidity for 1000 hours (+48, -0) with rated voltage applied. Remove from chamber and stabilize at room temperature for 24 ± 2 hours before measuring. | |
| | Capacitance Variation | ≤ ±5.0% or ± .5 pF, whichever is greater | | |
| | Q | ≥ 30 pF: Q ≥ 350 ≥10 pF, <30 pF: Q ≥ 275 +5C/2 <10 pF: Q ≥ 200 +10C | | |
| | Insulation Resistance | ≥ Initial Value x 0.3 (See Above) | | |
| Dielectric Strength | | Meets Initial Values (As Above) | | |

MM Series – MLCC for Medical Applications

NP0/COG Capacitance Range



PREFERRED SIZES ARE SHADED

| SIZE | | 0603 | | | | 0805 | | | | 1206 | | | | |
|------|------|------|------|----|-----|------|------|----|-----|------|------|----|-----|-----|
| WVDC | | 16 | 25 | 50 | 100 | 16 | 25 | 50 | 100 | 16 | 25 | 50 | 100 | |
| Cap | 0.5 | 0R5 | | | | | | | | | | | | |
| (pF) | 1.0 | 1R0 | | | | | | | | | | | | |
| | 1.2 | 1R2 | | | | | | | | | | | | |
| | 1.5 | 1R5 | | | | | | | | | | | | |
| | 1.8 | 1R8 | | | | | | | | | | | | |
| | 2.2 | 2R2 | | | | | | | | | | | | |
| | 2.7 | 2R7 | | | | | | | | | | | | |
| | 3.3 | 3R3 | | | | | | | | | | | | |
| | 3.9 | 3R9 | | | | | | | | | | | | |
| | 4.7 | 4R7 | | | | | | | | | | | | |
| | 5.6 | 5R6 | | | | | | | | | | | | |
| | 6.8 | 6R8 | | | | | | | | | | | | |
| | 8.2 | 8R2 | | | | | | | | | | | | |
| | 10 | 100 | | | | | | | | | | | | |
| | 12 | 120 | | | | | | | | | | | | |
| | 15 | 150 | | | | | | | | | | | | |
| | 18 | 180 | | | | | | | | | | | | |
| | 22 | 220 | | | | | | | | | | | | |
| | 27 | 270 | | | | | | | | | | | | |
| | 33 | 330 | | | | | | | | | | | | |
| | 39 | 390 | | | | | | | | | | | | |
| | 47 | 470 | | | | | | | | | | | | |
| | 56 | 560 | | | | | | | | | | | | |
| | 68 | 680 | | | | | | | | | | | | |
| | 82 | 820 | | | | | | | | | | | | |
| | 100 | 101 | | | | | | | | | | | | |
| | 120 | 121 | | | | | | | | | | | | |
| | 150 | 151 | | | | | | | | | | | | |
| | 180 | 181 | | | | | | | | | | | | |
| | 220 | 221 | | | | | | | | | | | | |
| | 270 | 271 | | | | | | | | | | | | |
| | 330 | 331 | | | | | | | | | | | | |
| | 390 | 391 | | | | | | | | | | | | |
| | 470 | 471 | | | | | | | | | | | | |
| | 560 | 561 | | | | | | | | | | | | |
| | 680 | 681 | | | | | | | | | | | | |
| | 820 | 821 | | | | | | | | | | | | |
| | 1000 | 102 | | | | | | | | | | | | |
| | 1200 | 122 | | | | | | | | | | | | |
| | 1500 | 152 | | | | | | | | | | | | |
| | WVDC | | 16 | 25 | 50 | 100 | 16 | 25 | 50 | 100 | 16 | 25 | 50 | 100 |
| | SIZE | | 0603 | | | | 0805 | | | | 1206 | | | |

MM Series – MLCC for Medical Applications

X7R Specifications and Test Methods

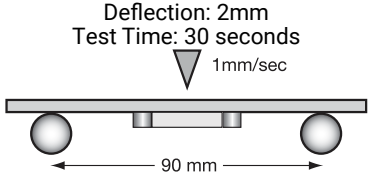
| Parameter/Test | | X7R Specification Limits | Measuring Conditions | |
|---------------------------------------|--|--|---|------------------|
| Operating Temperature Range | | -55°C to +125°C | Temperature Cycle Chamber | |
| Capacitance | | Within specified tolerance | Freq.: 1.0 kHz ± 10% Voltage: 1.0Vrms ± .2V | |
| Q | $\leq 10\%$ for $\geq 50V$ DC rating $\leq 12.5\%$ for 25V DC rating $\leq 12.5\%$ for 25V and 16V DC rating $\leq 12.5\%$ for $\leq 10V$ DC rating | | | |
| Insulation Resistance | | 100,000M Ω or 1000M Ω - μ F, whichever is less | Charge device with rated voltage for 120 ± 5 secs @ room temp/humidity | |
| Dielectric Strength | | No breakdown or visual defects | Charge device with 300% of rated voltage for 1-5 seconds, w/charge and discharge current limited to 50 mA (max) Note: Charge device with 150% of rated voltage for 500V devices. | |
| Resistance to Flexure Stresses | Appearance | No defects | Deflection: 2mm Test Time: 30 seconds  | |
| | Capacitance Variation | $\leq \pm 12\%$ | | |
| | Dissipation Factor | Meets Initial Values (As Above) | | |
| | Insulation Resistance | \geq Initial Value x 0.3 | | |
| Solderability | | $\geq 95\%$ of each terminal should be covered with fresh solder | Dip device in eutectic solder at 230 ± 5°C for 5.0 ± 0.5 seconds | |
| Resistance to Solder Heat | Appearance | No defects, <25% leaching of either end terminal | Dip device in eutectic solder at 260°C for 60 seconds. Store at room temperature for 24 ± 2 hours before measuring electrical properties. | |
| | Capacitance Variation | $\leq \pm 7.5\%$ | | |
| | Dissipation Factor | Meets Initial Values (As Above) | | |
| | Insulation Resistance | Meets Initial Values (As Above) | | |
| | Dielectric Strength | Meets Initial Values (As Above) | | |
| Thermal Shock | Appearance | No visual defects | Step 1: -55°C ± 2° | 30 ± 3 minutes |
| | Capacitance Variation | $\leq \pm 7.5\%$ | Step 2: Room Temp | ≤ 3 minutes |
| | Dissipation Factor | Meets Initial Values (As Above) | Step 3: +125°C ± 2° | 30 ± 3 minutes |
| | Insulation Resistance | Meets Initial Values (As Above) | Step 4: Room Temp | ≤ 3 minutes |
| | Dielectric Strength | Meets Initial Values (As Above) | Repeat for 5 cycles and measure after 24 ± 2 hours at room temperature | |
| Load Life | Appearance | No visual defects | Charge device with 1.5 rated voltage ($\leq 10V$) in test chamber set at 125°C ± 2°C for 1000 hours (+48, -0) Remove from test chamber and stabilize at room temperature for 24 ± 2 hours before measuring. | |
| | Capacitance Variation | $\leq \pm 12.5\%$ | | |
| | Dissipation Factor | \leq Initial Value x 2.0 (See Above) | | |
| | Insulation Resistance | \geq Initial Value x 0.3 (See Above) | | |
| | Dielectric Strength | Meets Initial Values (As Above) | | |
| Load Humidity | Appearance | No visual defects | Store in a test chamber set at 85°C ± 2°C/ 85% ± 5% relative humidity for 1000 hours (+48, -0) with rated voltage applied. Remove from chamber and stabilize at room temperature and humidity for 24 ± 2 hours before measuring. | |
| | Capacitance Variation | $\leq \pm 12.5\%$ | | |
| | Dissipation Factor | \leq Initial Value x 2.0 (See Above) | | |
| | Insulation Resistance | \geq Initial Value x 0.3 (See Above) | | |
| | Dielectric Strength | Meets Initial Values (As Above) | | |

MM Series – MLCC for Medical Applications

X7R Capacitance Range

PREFERRED SIZES ARE SHADED

| SIZE | 0402 | | | 0603 | | | | 0805 | | | | | 1206 | | | | | 1210 | | | | | 1808 | | | 1812 | | | | 2220 | | | | | | | | | | | | | | | | | | |
|------|-------|-----|----|------|----|----|----|------|-----|-----|----|----|------|-----|-----|-----|-----|------|----|----|-----|-----|------|-----|-----|------|----|----|-----|------|-----|-----|-----|-----|-----|-----|-----|-----|-----|-----|----|-----|-----|--|--|--|--|--|
| | WVDC | 16 | 25 | 50 | 10 | 16 | 25 | 50 | 100 | 200 | 10 | 16 | 25 | 50 | 100 | 200 | 250 | 10 | 16 | 25 | 50 | 100 | 200 | 250 | 500 | 10 | 16 | 25 | 50 | 100 | 200 | 250 | 500 | 50 | 100 | 200 | 50 | 100 | 200 | 250 | 25 | 50 | 100 | | | | | |
| Cap | 220 | 221 | | | | | | | | | | | | | | | | | | | | | | | | | | | | | | | | | | | | | | | | | | | | | | |
| (pF) | 270 | 271 | | | | | | | | | | | | | | | | | | | | | | | | | | | | | | | | | | | | | | | | | | | | | | |
| | 330 | 331 | | | | | | | | | | | | | | | | | | | | | | | | | | | | | | | | | | | | | | | | | | | | | | |
| | 390 | 391 | | | | | | | | | | | | | | | | | | | | | | | | | | | | | | | | | | | | | | | | | | | | | | |
| | 470 | 471 | | | | | | | | | | | | | | | | | | | | | | | | | | | | | | | | | | | | | | | | | | | | | | |
| | 560 | 561 | | | | | | | | | | | | | | | | | | | | | | | | | | | | | | | | | | | | | | | | | | | | | | |
| | 680 | 681 | | | | | | | | | | | | | | | | | | | | | | | | | | | | | | | | | | | | | | | | | | | | | | |
| | 820 | 821 | | | | | | | | | | | | | | | | | | | | | | | | | | | | | | | | | | | | | | | | | | | | | | |
| | 1000 | 102 | | | | | | | | | | | | | | | | | | | | | | | | | | | | | | | | | | | | | | | | | | | | | | |
| | 1200 | 122 | | | | | | | | | | | | | | | | | | | | | | | | | | | | | | | | | | | | | | | | | | | | | | |
| | 1500 | 152 | | | | | | | | | | | | | | | | | | | | | | | | | | | | | | | | | | | | | | | | | | | | | | |
| | 1800 | 182 | | | | | | | | | | | | | | | | | | | | | | | | | | | | | | | | | | | | | | | | | | | | | | |
| | 2200 | 222 | | | | | | | | | | | | | | | | | | | | | | | | | | | | | | | | | | | | | | | | | | | | | | |
| | 2700 | 272 | | | | | | | | | | | | | | | | | | | | | | | | | | | | | | | | | | | | | | | | | | | | | | |
| | 3300 | 332 | | | | | | | | | | | | | | | | | | | | | | | | | | | | | | | | | | | | | | | | | | | | | | |
| | 3900 | 392 | | | | | | | | | | | | | | | | | | | | | | | | | | | | | | | | | | | | | | | | | | | | | | |
| | 4700 | 472 | | | | | | | | | | | | | | | | | | | | | | | | | | | | | | | | | | | | | | | | | | | | | | |
| | 5600 | 562 | | | | | | | | | | | | | | | | | | | | | | | | | | | | | | | | | | | | | | | | | | | | | | |
| | 6800 | 682 | | | | | | | | | | | | | | | | | | | | | | | | | | | | | | | | | | | | | | | | | | | | | | |
| | 8200 | 822 | | | | | | | | | | | | | | | | | | | | | | | | | | | | | | | | | | | | | | | | | | | | | | |
| cap | 0.010 | 103 | | | | | | | | | | | | | | | | | | | | | | | | | | | | | | | | | | | | | | | | | | | | | | |
| uF | 0.012 | 123 | | | | | | | | | | | | | | | | | | | | | | | | | | | | | | | | | | | | | | | | | | | | | | |
| | 0.015 | 153 | | | | | | | | | | | | | | | | | | | | | | | | | | | | | | | | | | | | | | | | | | | | | | |
| | 0.018 | 183 | | | | | | | | | | | | | | | | | | | | | | | | | | | | | | | | | | | | | | | | | | | | | | |
| | 0.022 | 223 | | | | | | | | | | | | | | | | | | | | | | | | | | | | | | | | | | | | | | | | | | | | | | |
| | 0.027 | 273 | | | | | | | | | | | | | | | | | | | | | | | | | | | | | | | | | | | | | | | | | | | | | | |
| | 0.033 | 333 | | | | | | | | | | | | | | | | | | | | | | | | | | | | | | | | | | | | | | | | | | | | | | |
| | 0.039 | 393 | | | | | | | | | | | | | | | | | | | | | | | | | | | | | | | | | | | | | | | | | | | | | | |
| | 0.047 | 473 | | | | | | | | | | | | | | | | | | | | | | | | | | | | | | | | | | | | | | | | | | | | | | |
| | 0.056 | 563 | | | | | | | | | | | | | | | | | | | | | | | | | | | | | | | | | | | | | | | | | | | | | | |
| | 0.068 | 683 | | | | | | | | | | | | | | | | | | | | | | | | | | | | | | | | | | | | | | | | | | | | | | |
| | 0.082 | 823 | | | | | | | | | | | | | | | | | | | | | | | | | | | | | | | | | | | | | | | | | | | | | | |
| | 0.10 | 104 | | | | | | | | | | | | | | | | | | | | | | | | | | | | | | | | | | | | | | | | | | | | | | |
| | 0.12 | 124 | | | | | | | | | | | | | | | | | | | | | | | | | | | | | | | | | | | | | | | | | | | | | | |
| | 0.15 | 154 | | | | | | | | | | | | | | | | | | | | | | | | | | | | | | | | | | | | | | | | | | | | | | |
| | 0.22 | 224 | | | | | | | | | | | | | | | | | | | | | | | | | | | | | | | | | | | | | | | | | | | | | | |
| | 0.33 | 334 | | | | | | | | | | | | | | | | | | | | | | | | | | | | | | | | | | | | | | | | | | | | | | |
| | 0.47 | 474 | | | | | | | | | | | | | | | | | | | | | | | | | | | | | | | | | | | | | | | | | | | | | | |
| | 0.56 | 564 | | | | | | | | | | | | | | | | | | | | | | | | | | | | | | | | | | | | | | | | | | | | | | |
| | 0.68 | 684 | | | | | | | | | | | | | | | | | | | | | | | | | | | | | | | | | | | | | | | | | | | | | | |
| | 0.82 | 824 | | | | | | | | | | | | | | | | | | | | | | | | | | | | | | | | | | | | | | | | | | | | | | |
| | 1.0 | 105 | | | | | | | | | | | | | | | | | | | | | | | | | | | | | | | | | | | | | | | | | | | | | | |
| | 1.2 | 125 | | | | | | | | | | | | | | | | | | | | | | | | | | | | | | | | | | | | | | | | | | | | | | |
| | 1.5 | 155 | | | | | | | | | | | | | | | | | | | | | | | | | | | | | | | | | | | | | | | | | | | | | | |
| WVDC | 16 | 25 | 50 | 10 | 16 | 25 | 50 | 100 | 200 | 10 | 16 | 25 | 50 | 100 | 200 | 250 | 10 | 16 | 25 | 50 | 100 | 200 | 250 | 500 | 10 | 16 | 25 | 50 | 100 | 200 | 250 | 500 | 50 | 100 | 200 | 50 | 100 | 200 | 250 | 25 | 50 | 100 | | | | | | |
| SIZE | 0402 | | | 0603 | | | | 0805 | | | | | 1206 | | | | | 1210 | | | | | 1808 | | | 1812 | | | | 2220 | | | | | | | | | | | | | | | | | | |

Packaging of Chip Components

Automatic Insertion Packaging

TAPE & REEL QUANTITIES

All tape and reel specifications are in compliance with RS481.

| | 4mm | 8mm | 12mm | |
|---------------------------|-------|--|--------|--|
| Paper or Embossed Carrier | | 0612, 0508, 0805, 1206, 1210 | | |
| Embossed Only | 0101 | | 1808 | 1812, 1825 2220, 2225 |
| Paper Only | | 0101, 0201, 0306, 0402, 0603 | | |
| Qty. per Reel/7" Reel | 4,000 | 1,000, 2,000, 3,000 or 4,000, 10,000, 15,000, 20,000 Contact factory for exact quantity | 3,000 | 500, 1,000 Contact factory for exact quantity |
| Qty. per Reel/13" Reel | | 5,000, 10,000, 50,000 Contact factory for exact quantity | 10,000 | 4,000 |

REEL DIMENSIONS

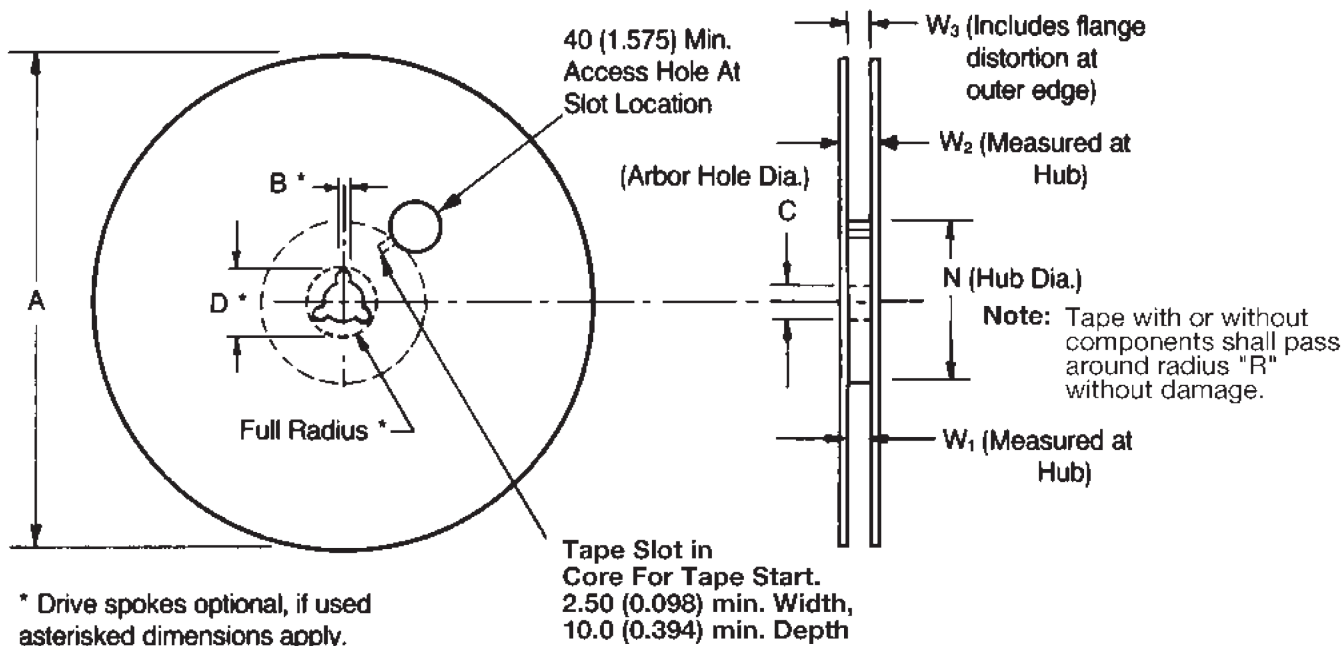

| Tape Size ⁽¹⁾ | A Max. | B* Min. | C | D* Min. | N Min. | W ₁ | W ₂ Max. | W ₃ |
|--------------------------|-----------------|----------------|--|-----------------|-----------------|--|---------------------|----------------------|
| 4mm | 1.80 (7.087) | 1.5 (0.059) | 13.0±0.5 (0.522±0.020) | 20.2 (0.795) | 60.0 (2.362) | 4.35±0.3 (0.171±0.011) | 7.95 (0.312) | |
| 8mm | 330 (12.992) | 1.5 (0.059) | 13.0 ^{+0.50} _{-0.20} (0.512 ^{+0.020} _{-0.008}) | 20.2 (0.795) | 50.0 (1.969) | 8.40 ^{+1.5} _{-0.0} (0.331 ^{+0.059} _{-0.0}) | 14.4 (0.567) | 7.90 Min. (0.311) |
| 12mm | | | | | | 12.4 ^{+2.0} _{-0.0} (0.488 ^{+0.079} _{-0.0}) | | 18.4 (0.724) |
| | | | | | | | | 11.9 Min. (0.469) |
| | | | | | | | | 15.4 Max. (0.607) |

Metric dimensions will govern.

English measurements rounded and for reference only.

(1) For tape sizes 16mm and 24mm (used with chip size 3640) consult EIA RS-481 latest revision.

Embossed Carrier Configuration

4, 8 & 12mm Tape Only

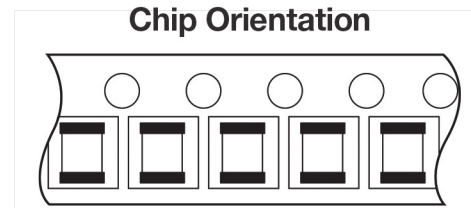
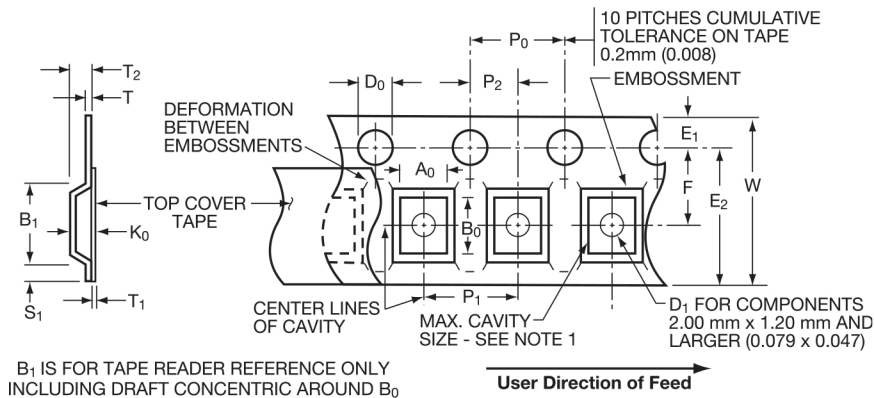

4, 8 & 12mm Embossed Tape Metric Dimensions Will Govern

CONSTANT DIMENSIONS

| Tape Size | D ₀ | E ₁ | P ₀ | P ₂ | S ₁ Min. | T Max. | T ₁ Max. |
|---------------|---|--------------------------------|-------------------------------|-------------------------------|---------------------|-----------------|---------------------|
| 4mm | 0.80±0.04 (0.031±0.001) | 0.90±0.05 (0.035±0.001) | 2.0±0.04 (0.078±0.001) | 1.00±0.02 (0.039±0.0007) | 1.075 (0.042) | 0.26 (0.010) | 0.06 (0.002) |
| 8mm & 12mm | 1.50 ^{+0.10} _{-0.0} (0.059 ^{+0.004} _{-0.0}) | 1.75 ± 0.10 (0.069 ± 0.004) | 4.0 ± 0.10 (0.157 ± 0.004) | 2.0 ± 0.05 (0.079 ± 0.002) | 0.60 (0.024) | 0.60 (0.024) | 0.10 (0.004) |

VARIABLE DIMENSIONS

| Tape Size | B ₁ Max. | D ₁ Min. | E ₂ Min. | F | P ₁ See Note 5 | R Min. See Note 2 | T ₂ | W Max. | A ₀ B ₀ K ₀ |
|-------------------|---------------------|---------------------|---------------------|--------------------------------|--------------------------------|----------------------|----------------------|-----------------|--|
| 8mm | 4.35 (0.171) | 1.00 (0.039) | 6.25 (0.246) | 3.50 ± 0.05 (0.138 ± 0.002) | 4.00 ± 0.10 (0.157 ± 0.004) | 25.0 (0.984) | 2.50 Max. (0.098) | 8.30 (0.327) | See Note 1 |
| 12mm | 8.20 (0.323) | 1.50 (0.059) | 10.25 (0.404) | 5.50 ± 0.05 (0.217 ± 0.002) | 4.00 ± 0.10 (0.157 ± 0.004) | 30.0 (1.181) | 6.50 Max. (0.256) | 12.3 (0.484) | See Note 1 |
| 8mm 1/2 Pitch | 4.35 (0.171) | 1.00 (0.039) | 6.25 (0.246) | 3.50 ± 0.05 (0.138 ± 0.002) | 2.00 ± 0.10 (0.079 ± 0.004) | 25.0 (0.984) | 2.50 Max. (0.098) | 8.30 (0.327) | See Note 1 |
| 12mm Double Pitch | 8.20 (0.323) | 1.50 (0.059) | 10.25 (0.404) | 5.50 ± 0.05 (0.217 ± 0.002) | 8.00 ± 0.10 (0.315 ± 0.004) | 30.0 (1.181) | 6.50 Max. (0.256) | 12.3 (0.484) | See Note 1 |

NOTES:

- The cavity defined by A₀, B₀, and K₀ shall be configured to provide the following:
 - Surround the component with sufficient clearance such that:
 - the component does not protrude beyond the sealing plane of the cover tape.
 - the component can be removed from the cavity in a vertical direction without mechanical restriction, after the cover tape has been removed.
 - rotation of the component is limited to 20° maximum (see Sketches D & E).
 - lateral movement of the component is restricted to 0.5mm maximum (see Sketch F).
- Tape with or without components shall pass around radius "R" without damage.

- Bar code labeling (if required) shall be on the side of the reel opposite the round sprocket holes. Refer to EIA-556.
- B₁ dimension is a reference dimension for tape feeder clearance only.
- If P₁ = 2.0mm, the tape may not properly index in all tape feeders.

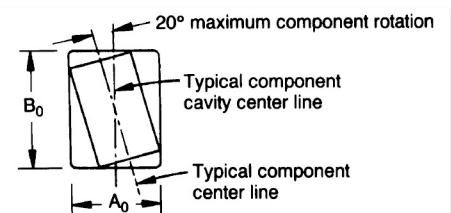
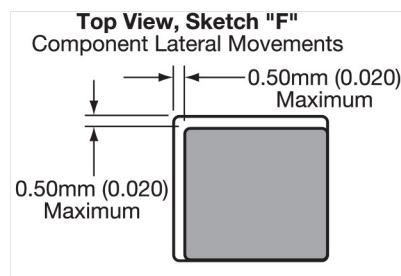
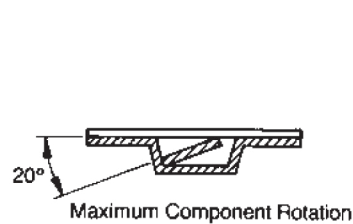

Paper Carrier Configuration

8 & 12mm Tape Only

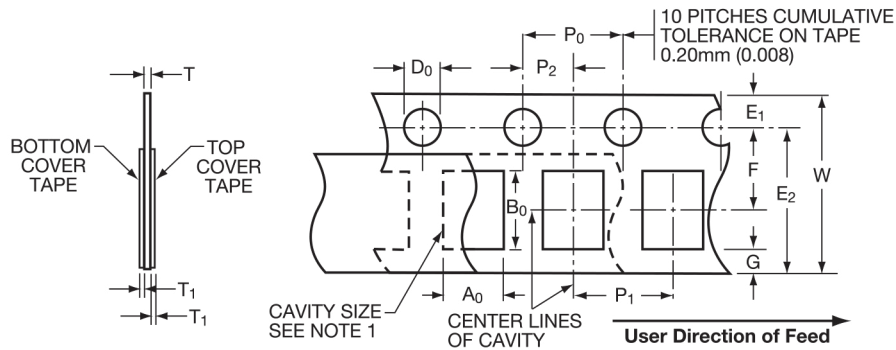

4, 8 & 12mm Embossed Tape Metric Dimensions Will Govern

CONSTANT DIMENSIONS

| Tape Size | D ₀ | E | P ₀ | P ₂ | T ₁ | G. Min. | R Min. |
|--------------|---|--------------------------------|--------------------------------|--------------------------------|-------------------------|-------------------------|------------------------------------|
| 8mm and 12mm | 1.50 ^{+0.10} _{-0.0} (0.059 ^{+0.004} _{-0.0}) | 1.75 ± 0.10 (0.069 ± 0.004) | 4.00 ± 0.10 (0.157 ± 0.004) | 2.00 ± 0.05 (0.079 ± 0.002) | 0.10 (0.004) Max. | 0.75 (0.030) Min. | 25.0 (0.984) See Note 2 Min. |

VARIABLE DIMENSIONS

| Tape Size | P ₁ See Note 4 | E ₂ Min. | F | W | A ₀ B ₀ | T |
|-------------------------|--------------------------------|---------------------|--------------------------------|--|-------------------------------|--|
| 8mm | 4.00 ± 0.10 (0.157 ± 0.004) | 6.25 (0.246) | 3.50 ± 0.05 (0.138 ± 0.002) | 8.00 ^{+0.30} _{-0.10} (0.315 ^{+0.012} _{-0.004}) | See Note 1 | 1.10mm (0.043) Max. for Paper Base Tape and 1.60mm (0.063) Max. for Non-Paper Base Compositions |
| 12mm | 4.00 ± 0.10 (0.157 ± 0.004) | 10.25 (0.404) | 5.50 ± 0.05 (0.217 ± 0.002) | 12.0 ± 0.30 (0.472 ± 0.012) | | |
| 8mm 1/2 Pitch | 2.00 ± 0.05 (0.079 ± 0.002) | 6.25 (0.246) | 3.50 ± 0.05 (0.138 ± 0.002) | 8.00 ^{+0.30} _{-0.10} (0.315 ^{+0.012} _{-0.004}) | | |
| 12mm Double Pitch | 8.00 ± 0.10 (0.315 ± 0.004) | 10.25 (0.404) | 5.50 ± 0.05 (0.217 ± 0.002) | 12.0 ± 0.30 (0.472 ± 0.012) | | |

NOTES:

- The cavity defined by A₀, B₀, and T shall be configured to provide sufficient clearance surrounding the component so that:
 - the component does not protrude beyond either surface of the carrier tape;
 - the component can be removed from the cavity in a vertical direction without mechanical restriction after the top cover tape has been removed;
 - rotation of the component is limited to 20° maximum (see Sketches A & B);
 - lateral movement of the component is restricted to 0.5mm maximum (see Sketch C).
- Tape with or without components shall pass around radius "R" without damage.

3. Bar code labeling (if required) shall be on the side of the reel opposite the sprocket holes. Refer to EIA-556.

4. If P₁ = 2.0mm, the tape may not properly index in all tape feeders.

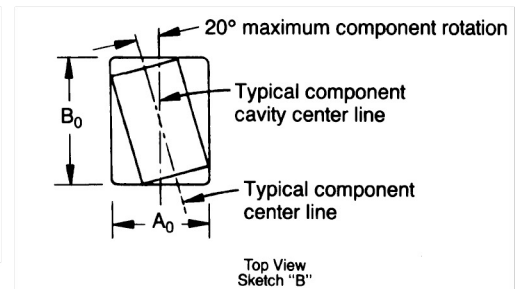
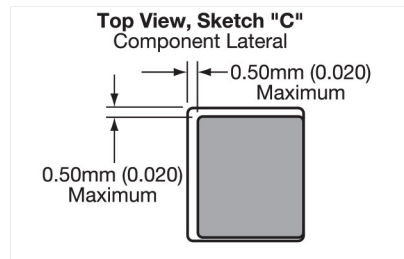
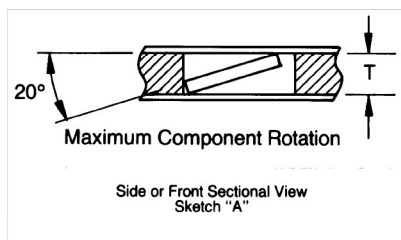

Bar Code Labeling Standard

AVX bar code labeling is available and follows latest version of EIA-556

Basic Capacitor Formulas

I. Capacitance (farads)

$$\text{English: } C = \frac{.224 \text{ K A}}{T_D}$$

$$\text{Metric: } C = \frac{.0884 \text{ K A}}{T_D}$$

II. Energy stored in capacitors (Joules, watt - sec)

$$E = \frac{1}{2} CV^2$$

III. Linear charge of a capacitor (Amperes)

$$I = C \frac{dV}{dt}$$

IV. Total Impedance of a capacitor (ohms)

$$Z = \sqrt{R_S^2 + (X_C - X_L)^2}$$

V. Capacitive Reactance (ohms)

$$X_C = \frac{1}{2 \pi fC}$$

VI. Inductive Reactance (ohms)

$$X_L = 2 \pi fL$$

VII. Phase Angles:

Ideal Capacitors: Current leads voltage 90°

Ideal Inductors: Current lags voltage 90°

Ideal Resistors: Current in phase with voltage

VIII. Dissipation Factor (%)

$$D.F. = \tan \delta \text{ (loss angle)} = \frac{E.S.R.}{X_C} = (2 \pi fC) (E.S.R.)$$

IX. Power Factor (%)

P.F. = Sine (loss angle) = Cos ϕ (phase angle)

P.F. = (when less than 10%) = DF

X. Quality Factor (dimensionless)

$$Q = \text{Cotan } \delta \text{ (loss angle)} = \frac{1}{D.F.}$$

XI. Equivalent Series Resistance (ohms)

$$E.S.R. = (D.F.) (X_C) = (D.F.) / (2 \pi fC)$$

XII. Power Loss (watts)

$$\text{Power Loss} = (2 \pi fCV^2) (D.F.)$$

XIII. KVA (Kilowatts)

$$KVA = 2 \pi fCV^2 \times 10^{-3}$$

XIV. Temperature Characteristic (ppm/°C)

$$T.C. = \frac{C_t - C_{25}}{C_{25} (T_t - 25)} \times 10^6$$

XV. Cap Drift (%)

$$C.D. = \frac{C_1 - C_2}{C_1} \times 100$$

XVI. Reliability of Ceramic Capacitors

$$L_0 = \left(\frac{V_t}{V_0} \right)^X \left(\frac{T_t}{T_0} \right)^Y$$

XVII. Capacitors in Series (current the same)

$$\text{Any Number: } \frac{1}{C_T} = \frac{1}{C_1} + \frac{1}{C_2} \dots \frac{1}{C_N}$$

$$\text{Two: } C_T = \frac{C_1 C_2}{C_1 + C_2}$$

XVIII. Capacitors in Parallel (voltage the same)

$$C_T = C_1 + C_2 \dots + C_N$$

XIX. Aging Rate

$$A.R. = \% \Delta C / \text{decade of time}$$

XX. Decibels

$$db = 20 \log \frac{V_1}{V_2}$$

METRIC PREFIXES

| | |
|-------|---------------------|
| Pico | X 10 ⁻¹² |
| Nano | X 10 ⁻⁹ |
| Micro | X 10 ⁻⁶ |
| Milli | X 10 ⁻³ |
| Deci | X 10 ⁻¹ |
| Deca | X 10 ⁺¹ |
| Kilo | X 10 ⁺³ |
| Mega | X 10 ⁺⁶ |
| Giga | X 10 ⁺⁹ |
| Tera | X 10 ⁺¹² |

SYMBOLS

| | | |
|---------------------------------------|--|--|
| K = Dielectric Constant | f = frequency | L _t = Test life |
| A = Area | L = Inductance | V _t = Test voltage |
| T _D = Dielectric thickness | δ = Loss angle | V _o = Operating voltage |
| V = Voltage | ϕ = Phase angle | T _t = Test temperature |
| t = time | X & Y = exponent effect of voltage and temp. | T _o = Operating temperature |
| R _s = Series Resistance | L _o = Operating life | |

General Description

Basic Construction – A multilayer ceramic (MLC) capacitor is a monolithic block of ceramic containing two sets of offset, interleaved planar electrodes that extend to two opposite surfaces of the ceramic dielectric. This simple structure requires a considerable amount of sophistication, both in material and manufacture, to produce it in the quality and quantities needed in

today's electronic equipment.

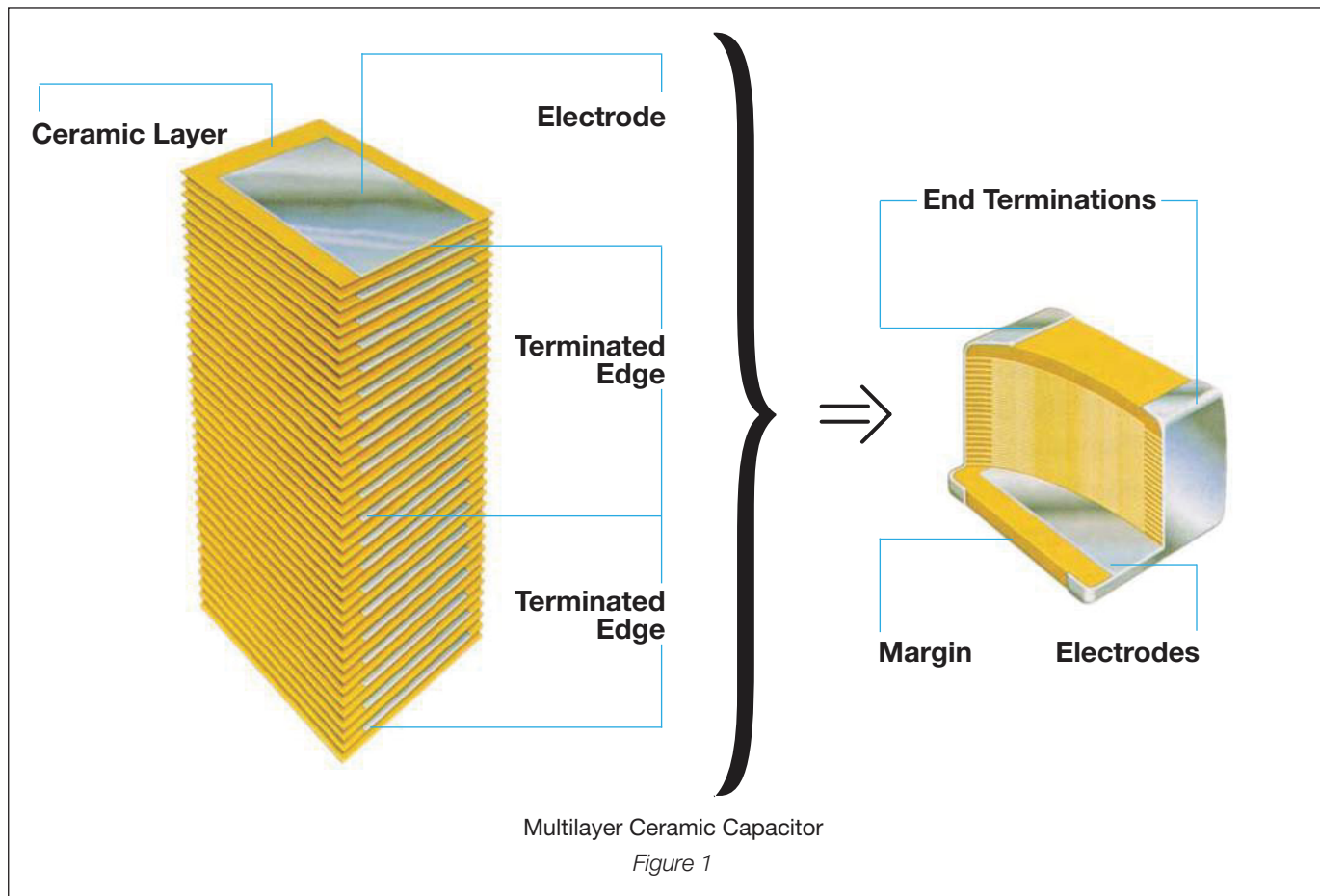

Formulations – Multilayer ceramic capacitors are available in both Class 1 and Class 2 formulations. Temperature compensating formulations are Class 1 and temperature stable and general application formulations are classified as Class 2.

Class 1 – Class 1 capacitors or temperature compensating capacitors are usually made from mixtures of titanates where barium titanate is normally not a major part of the mix. They have predictable temperature coefficients and in general, do not have an aging characteristic. Thus they are the most stable capacitor available. The most popular Class 1 multilayer ceramic capacitors are COG (NP0) temperature compensating capacitors (negative-positive 0 ppm/°C).

Class 2 – EIA Class 2 capacitors typically are based on the chemistry of barium titanate and provide a wide range of capacitance values and temperature stability. The most commonly used Class 2 dielectrics are X7R and Y5V. The X7R provides intermediate capacitance values which vary only $\pm 15\%$ over the temperature range of -55°C to 125°C . It finds applications where stability over a wide temperature range is required.

The Y5V provides the highest capacitance values and is used in applications where limited temperature changes are expected. The capacitance value for Y5V can vary from 22% to -82% over the -30°C to 85°C temperature range.

All Class 2 capacitors vary in capacitance value under the influence of temperature, operating voltage (both AC and DC), and frequency. For additional information on performance changes with operating conditions, consult AVX's software, SpiCap.

General Description

Table 1: EIA and MIL Temperature Stable and General Application Codes

| EIA CODE | |
|--|-------------------------|
| Percent Capacity Change Over Temperature Range | |
| RS198 | Temperature Range |
| X7 | -55°C to +125°C |
| X6 | -55°C to +105°C |
| X5 | -55°C to +85°C |
| Y5 | -30°C to +85°C |
| Z5 | +10°C to +85°C |
| Code | Percent Capacity Change |
| D | ±3.3% |
| E | ±4.7% |
| F | ±7.5% |
| P | ±10% |
| R | ±15% |
| S | ±22% |
| T | +22%, -33% |
| U | +22%, -56% |
| V | +22%, -82% |

EXAMPLE – A capacitor is desired with the capacitance value at 25°C to increase no more than 7.5% or decrease no more than 7.5% from -30°C to +85°C. EIA Code will be Y5F.

| MIL CODE | | |
|----------|------------------------|-------------------------|
| Symbol | Temperature Range | |
| A | -55°C to +85°C | |
| B | -55°C to +125°C | |
| C | -55°C to +150°C | |
| Symbol | Cap. Change Zero Volts | Cap. Change Rated Volts |
| R | +15%, -15% | +15%, -40% |
| S | +22%, -22% | +22%, -56% |
| W | +22%, -56% | +22%, -66% |
| X | +15%, -15% | +15%, -25% |
| Y | +30%, -70% | +30%, -80% |
| Z | +20%, -20% | +20%, -30% |

Temperature characteristic is specified by combining range and change symbols, for example BR or AW. Specification slash sheets indicate the characteristic applicable to a given style of capacitor.

In specifying capacitance change with temperature for Class 2 materials, EIA expresses the capacitance change over an operating temperature range by a 3 symbol code. The first symbol represents the cold temperature end of the temperature range, the second represents the upper limit of the operating temperature range and the third symbol represents the capacitance change allowed over the operating temperature range. Table 1 provides a detailed explanation of the EIA system.

Effects of Voltage – Variations in voltage have little effect on Class 1 dielectric but does affect the capacitance and dissipation factor of Class 2 dielectrics. The application of DC voltage reduces both the capacitance and dissipation factor while the application of an AC voltage within a reasonable range tends to increase both capacitance and dissipation factor readings. If a high enough AC voltage is applied, eventually it will reduce capacitance just as a DC voltage will. Figure 2 shows the effects of AC voltage.

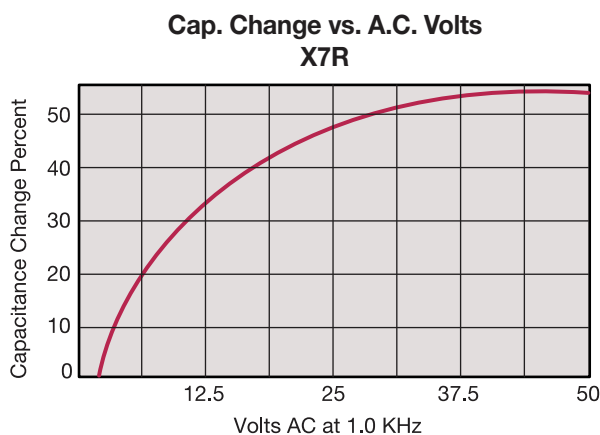

Figure 2

Capacitor specifications specify the AC voltage at which to measure (normally 0.5 or 1 VAC) and application of the wrong voltage can cause spurious readings. Figure 3 gives the voltage coefficient of dissipation factor for various AC voltages at 1 kilohertz. Applications of different frequencies will affect the percentage changes versus voltages.

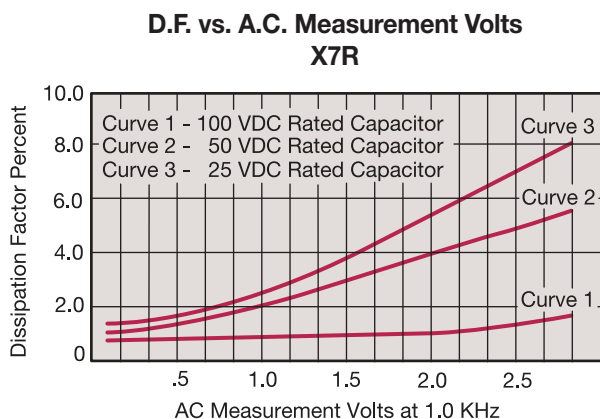
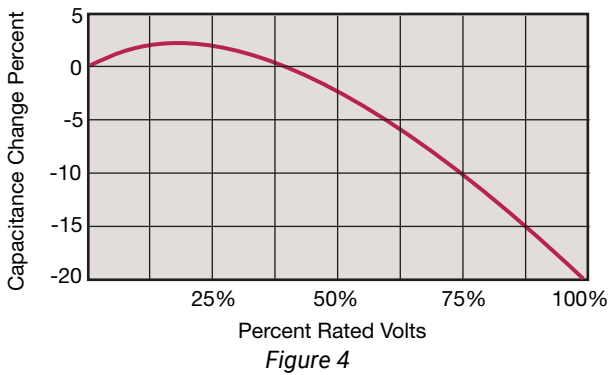

Figure 3

Typical effect of the application of DC voltage is shown in Figure 4. The voltage coefficient is more pronounced for higher K dielectrics. These figures are shown for room temperature conditions. The combination characteristic known as voltage temperature limits which shows the effects of rated voltage over the operating temperature range is shown in Figure 5 for the military BX characteristic.

General Description

**Example Change vs. D.C. Volts
X7R**



**Example Cap. Change vs. Temperature
X7R**

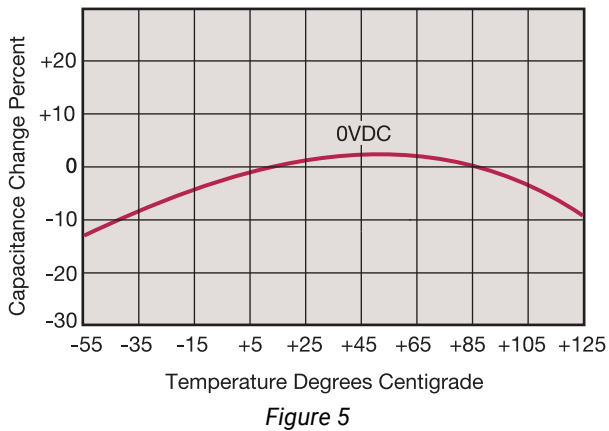
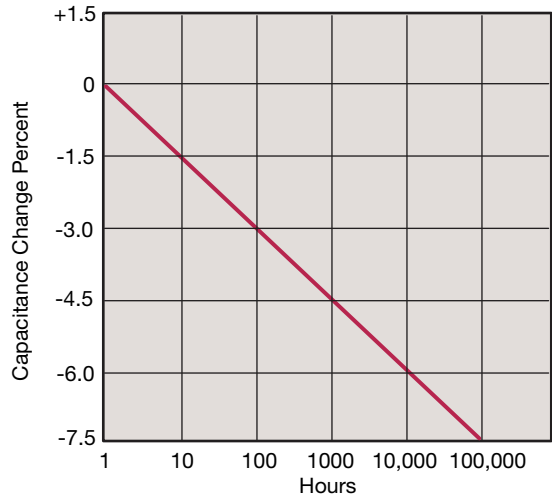

Figure 5

Effects of Time – Class 2 ceramic capacitors change capacitance and dissipation factor with time as well as temperature, voltage and frequency. This change with time is known as aging. Aging is caused by a gradual re-alignment of the crystalline structure of the ceramic and produces an exponential loss in capacitance and decrease in dissipation factor versus time. A typical curve of aging rate for semistable ceramics is shown in Figure 6.

If a Class 2 ceramic capacitor that has been sitting on the shelf for a period of time, is heated above its curie point, (125°C for 4 hours or 150°C for 1/2 hour will suffice) the part will de-age and return to its initial capacitance and dissipation factor readings. Because the capacitance changes rapidly, immediately after de-aging, the basic capacitance measurements are normally referred to a time period sometime after the de-aging process. Various manufacturers use different time bases but the most popular one is one day or twenty-four hours after “last heat.” Change in the aging curve can be caused by the application of voltage and other stresses. The possible changes in capacitance due to de-aging by heating the unit explain why capacitance changes are allowed after test, such as temperature cycling, moisture resistance, etc., in MIL specs. The application of high voltages such as dielectric withstanding voltages also tends to de-age capacitors and is why re-reading of capacitance after 12 or 24 hours is allowed in military specifications after dielectric strength tests have been performed.

**Example Curve of Aging Rate
X7R**



| Characteristic | Max. Aging Rate %/Decade |
|----------------|--------------------------|
| C0G (NP0) | None |
| X7R, X5R | 2 |
| Y5V | 7 |

Figure 6

Effects of Frequency – Frequency affects capacitance and impedance characteristics of capacitors. This effect is much more pronounced in high dielectric constant ceramic formulation than in low K formulations. AVX’s SpiCap software generates impedance, ESR, series inductance, series resonant frequency and capacitance all as functions of frequency, temperature and DC bias for standard chip sizes and styles. It is available free from AVX and can be downloaded for free from AVX website: www.avx.com.



General Description

Effects of Mechanical Stress – High “K” dielectric ceramic capacitors exhibit some low level piezoelectric reactions under mechanical stress. As a general statement, the piezoelectric output is higher, the higher the dielectric constant of the ceramic. It is desirable to investigate this effect before using high “K” dielectrics as coupling capacitors in extremely low level applications.

Reliability – Historically ceramic capacitors have been one of the most reliable types of capacitors in use today. The approximate formula for the reliability of a ceramic capacitor is:

$$\frac{L_o}{L_t} = \left(\frac{V_t}{V_o}\right)^X \left(\frac{T_t}{T_o}\right)^Y$$

where

| | |
|---------------------------|-------------------------------|
| L_o = operating life | T_t = test temperature and |
| L_t = test life | T_o = operating temperature |
| V_t = test voltage | in °C |
| V_o = operating voltage | X, Y = see text |

Historically for ceramic capacitors exponent X has been considered as 3. The exponent Y for temperature effects typically tends to run about 8.

A capacitor is a component which is capable of storing electrical energy. It consists of two conductive plates (electrodes) separated by insulating material which is called the dielectric. A typical formula for determining capacitance is:

$$C = \frac{.224 KA}{t}$$

| |
|--|
| C = capacitance (picofarads) |
| K = dielectric constant (Vacuum = 1) |
| A = area in square inches |
| t = separation between the plates in inches (thickness of dielectric) |
| $.224$ = conversion constant (.0884 for metric system in cm) |

Capacitance – The standard unit of capacitance is the farad. A capacitor has a capacitance of 1 farad when 1 coulomb charges it to 1 volt. One farad is a very large unit and most capacitors have values in the micro (10^{-6}), nano (10^{-9}) or pico (10^{-12}) farad level.

Dielectric Constant – In the formula for capacitance given above the dielectric constant of a vacuum is arbitrarily chosen as the number 1. Dielectric constants of other materials are then compared to the dielectric constant of a vacuum.

Dielectric Thickness – Capacitance is indirectly proportional to the separation between electrodes. Lower voltage requirements mean thinner dielectrics and greater capacitance per volume.

Area – Capacitance is directly proportional to the area of the electrodes. Since the other variables in the equation are usually set by the performance desired, area is the easiest parameter to modify to obtain a specific capacitance within a material group.

Energy Stored – The energy which can be stored in a capacitor is given by the formula:

$$E = \frac{1}{2}CV^2$$

| |
|------------------------------------|
| E = energy in joules (watts-sec) |
| V = applied voltage |
| C = capacitance in farads |

Potential Change – A capacitor is a reactive component which reacts against a change in potential across it. This is shown by the equation for the linear charge of a capacitor:

$$I_{ideal} = C \frac{dV}{dt}$$

where

| |
|--|
| I = Current |
| C = Capacitance |
| dV/dt = Slope of voltage transition across capacitor |

Thus an infinite current would be required to instantly change the potential across a capacitor. The amount of current a capacitor can “sink” is determined by the above equation.

Equivalent Circuit – A capacitor, as a practical device, exhibits not only capacitance but also resistance and inductance. A simplified schematic for the equivalent circuit is:

| | |
|---------------------------|-----------------------------|
| C = Capacitance | L = Inductance |
| R_s = Series Resistance | R_p = Parallel Resistance |

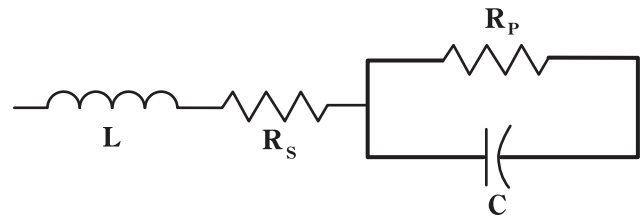

Reactance – Since the insulation resistance (R_p) is normally very high, the total impedance of a capacitor is:

$$Z = \sqrt{R_s^2 + (X_C - X_L)^2}$$

where

| | |
|------------------------------|------------------------|
| Z = Total Impedance | |
| R_s = Series Resistance | |
| X_C = Capacitive Reactance | $= \frac{1}{2 \pi fC}$ |
| X_L = Inductive Reactance | $= 2 \pi fL$ |

The variation of a capacitor’s impedance with frequency determines its effectiveness in many applications.

Phase Angle – Power Factor and Dissipation Factor are often confused since they are both measures of the loss in a capacitor under AC application and are often almost identical in value. In a “perfect” capacitor the current in the capacitor will lead the voltage by 90° .

General Description

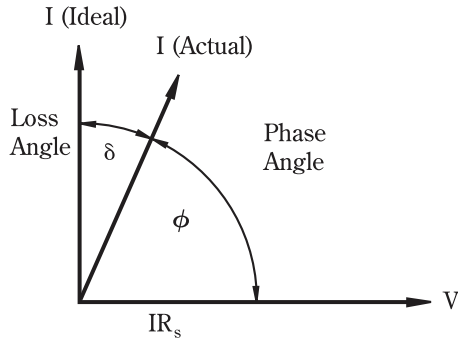

In practice the current leads the voltage by some other phase angle due to the series resistance R_s . The complement of this angle is called the loss angle and:

$$\text{Power Factor (P.F.)} = \cos \phi \text{ or } \sin \delta$$

$$\text{Dissipation Factor (D.F.)} = \tan \delta$$

for small values of the tan and sine are essentially equal which has led to the common interchangeability of the two terms in the industry.

Equivalent Series Resistance – The term E.S.R. or Equivalent Series Resistance combines all losses both series and parallel in a capacitor at a given frequency so that the equivalent circuit is reduced to a simple R-C series connection.

Dissipation Factor – The DF/PF of a capacitor tells what percent of the apparent power input will turn to heat in the capacitor.

$$\text{Dissipation Factor} = \frac{\text{E.S.R.}}{X_C} = (2 \pi fC) (\text{E.S.R.})$$

The watts loss are:

$$\text{Watts loss} = (2 \pi fCV^2) (\text{D.F.})$$

Very low values of dissipation factor are expressed as their reciprocal for convenience. These are called the “Q” or Quality factor of capacitors.

Parasitic Inductance – The parasitic inductance of capacitors is becoming more and more important in the decoupling of today’s high speed digital systems. The relationship between the inductance and the ripple voltage induced on the DC voltage line can be seen from the simple inductance equation:

$$V = L \frac{di}{dt}$$

The $\frac{di}{dt}$ seen in current microprocessors can be as high as 0.3 A/ns, and up to 10A/ns. At 0.3 A/ns, 100pH of parasitic inductance can cause a voltage spike of 30mV. While this does not sound very drastic, with the V_{cc} for microprocessors decreasing at the current rate, this can be a fairly large percentage.

Another important, often overlooked, reason for knowing the parasitic inductance is the calculation of the resonant frequency. This can be important for high frequency, bypass capacitors, as the resonant point will give the most signal attenuation. The resonant frequency is calculated from the simple equation:

$$f_{res} = \frac{1}{2\pi\sqrt{LC}}$$

Insulation Resistance – Insulation Resistance is the resistance measured across the terminals of a capacitor and consists principally of the parallel resistance R_P shown in the equivalent circuit. As capacitance values and hence the area of dielectric increases, the I.R. decreases and hence the product ($C \times IR$ or RC) is often specified in ohm farads or more commonly megohm-microfarads. Leakage current is determined by dividing the rated voltage by IR (Ohm’s Law).

Dielectric Strength – Dielectric Strength is an expression of the ability of a material to withstand an electrical stress. Although dielectric strength is ordinarily expressed in volts, it is actually dependent on the thickness of the dielectric and thus is also more generically a function of volts/mil.

Dielectric Absorption – A capacitor does not discharge instantaneously upon application of a short circuit, but drains gradually after the capacitance proper has been discharged. It is common practice to measure the dielectric absorption by determining the “reappearing voltage” which appears across a capacitor at some point in time after it has been fully discharged under short circuit conditions.

Corona – Corona is the ionization of air or other vapors which causes them to conduct current. It is especially prevalent in high voltage units but can occur with low voltages as well where high voltage gradients occur. The energy discharged degrades the performance of the capacitor and can in time cause catastrophic failures.

REFLOW SOLDERING

| Case Size | D1 | D2 | D3 | D4 | D5 |
|-------------|--------------|--------------|--------------|--------------|--------------|
| 0201 | 0.85 (0.033) | 0.30 (0.012) | 0.25 (0.010) | 0.30 (0.012) | 0.35 (0.014) |
| 0402 | 1.70 (0.067) | 0.60 (0.024) | 0.50 (0.020) | 0.60 (0.024) | 0.50 (0.020) |
| 0603 | 2.30 (0.091) | 0.80 (0.031) | 0.70 (0.028) | 0.80 (0.031) | 0.75 (0.030) |
| 0805 | 3.00 (0.118) | 1.00 (0.039) | 1.00 (0.039) | 1.00 (0.039) | 1.25 (0.049) |
| 1206 | 4.00 (0.157) | 1.00 (0.039) | 2.00 (0.079) | 1.00 (0.039) | 1.60 (0.063) |
| 1210 | 4.00 (0.157) | 1.00 (0.039) | 2.00 (0.079) | 1.00 (0.039) | 2.50 (0.098) |
| 1808 | 5.60 (0.220) | 1.00 (0.039) | 3.60 (0.142) | 1.00 (0.039) | 2.00 (0.079) |
| 1812 | 5.60 (0.220) | 1.00 (0.039) | 3.60 (0.142) | 1.00 (0.039) | 3.00 (0.118) |
| 1825 | 5.60 (0.220) | 1.00 (0.039) | 3.60 (0.142) | 1.00 (0.039) | 6.35 (0.250) |
| 2220 | 6.60 (0.260) | 1.00 (0.039) | 4.60 (0.181) | 1.00 (0.039) | 5.00 (0.197) |
| 2225 | 6.60 (0.260) | 1.00 (0.039) | 4.60 (0.181) | 1.00 (0.039) | 6.35 (0.250) |

Dimensions in millimeters (inches)

Component Pad Design

Component pads should be designed to achieve good solder files and minimize component movement during reflow soldering. Pad designs are given below for the most common sizes of multilayer ceramic capacitors for both wave and reflow soldering. The basis of these designs is:

- Pad width equal to component width. It is permissible to

decrease this to as low as 85% of component width but it is not advisable to go below this.

- Pad overlap 0.5mm beneath component.
- Pad extension 0.5mm beyond components for reflow and 1.0mm for wave soldering.

WAVE SOLDERING

| Case Size | D1 | D2 | D3 | D4 | D5 |
|-------------|-------------|-------------|-------------|-------------|-------------|
| 0603 | 3.10 (0.12) | 1.20 (0.05) | 0.70 (0.03) | 1.20 (0.05) | 0.75 (0.03) |
| 0805 | 4.00 (0.15) | 1.50 (0.06) | 1.00 (0.04) | 1.50 (0.06) | 1.25 (0.05) |
| 1206 | 5.00 (0.19) | 1.50 (0.06) | 2.00 (0.09) | 1.50 (0.06) | 1.60 (0.06) |

Dimensions in millimeters (inches)

Component Spacing

For wave soldering components, must be spaced sufficiently far apart to avoid bridging or shadowing (inability of solder to penetrate properly into small spaces). This is less important for reflow soldering but sufficient space must be allowed to enable rework should it be required.

Preheat & Soldering

The rate of preheat should not exceed 4°C/second to prevent thermal shock. A better maximum figure is about 2°C/second.

For capacitors size 1206 and below, with a maximum thickness of 1.25mm, it is generally permissible to allow a temperature differential from preheat to soldering of 150°C. In all other cases this differential should not exceed 100°C.

For further specific application or process advice, please consult AVX.

Cleaning

Care should be taken to ensure that the capacitors are thoroughly cleaned of flux residues especially the space beneath the capacitor. Such residues may otherwise become conductive and effectively offer a low resistance bypass to the capacitor.

Ultrasonic cleaning is permissible, the recommended conditions being 8 Watts/litre at 20-45 kHz, with a process cycle of 2 minutes vapor rinse, 2 minutes immersion in the ultrasonic solvent bath and finally 2 minutes vapor rinse.

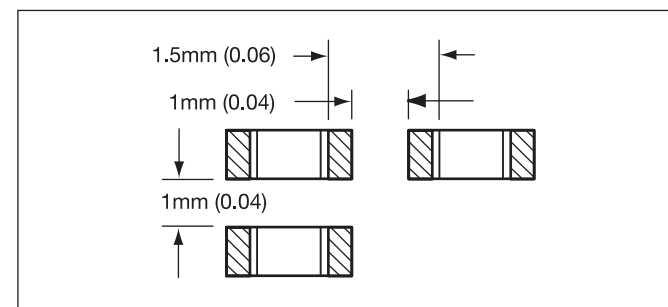

Surface Mounting Guide

Recommended Soldering Profiles

REFLOW SOLDER PROFILES

AVX RoHS compliant products utilize termination finishes (e.g. Sn or SnAg) that are compatible with all Pb-Free soldering systems and are fully reverse compatible with SnPb soldering systems. A recommended SnPb profile is shown for comparison; for Pb-Free soldering, IPC/ JEDEC- STD-020C may be referenced. The upper line in the chart shows the maximum envelope to which products are qualified (typically 3x reflow cycles at 260°C max). The center line gives the recommended profile for optimum wettability and soldering in Pb-Free Systems.

Preheat:

The pre-heat stabilizes the part and reduces the temperature differential prior to reflow. The initial ramp to 125°C may be rapid, but from that point (2-3)°C/sec is recommended to allow ceramic parts to heat uniformly and plastic encapsulated parts to stabilize through the glass transition temperature of the body (~ 180°C).

Reflow:

In the reflow phase, the maximum recommended time > 230°C is 40secs. Time at peak reflow is 10secs max.; optimum reflow is achieved at 250°C, (see wetting balance chart opposite) but products are qualified to 260°C max. Please reference individual product datasheets for maximum limits

Cool Down:

Cool down should not be forced and 6°C/sec is recommended. A slow cool down will result in a finer grain structure of the reflow solder in the solder fillet.

WAVE SOLDER PROFILES

For wave solder, there is no change in the recommended wave profile; all standard Pb-Free (SnCu/SnCuAg) systems operate at the same 260°C max recommended for SnPb systems.

Preheat:

This is more important for wave solder; a higher temperature preheat will reduce the thermal shock to SMD parts that are immersed (please consult individual product data sheets for SMD parts that are suited to wave solder). SMD parts should ideally be heated from the bottom-Side prior to wave. PTH (Pin through hole) parts on the topside should not be separately heated.

Wave:

250°C – 260°C recommended for optimum solderability.

Cool Down:

As with reflow solder, cool down should not be forced and 6°C/sec is recommended. Any air knives at the end of the 2nd wave should be heated.

Recommended Reflow Profiles

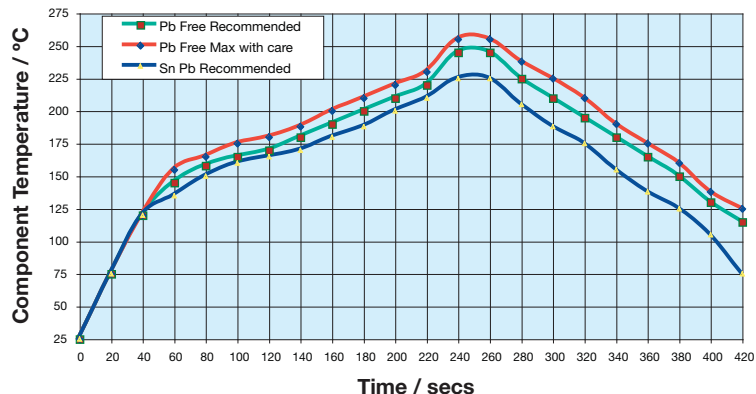

Wetting Force at 2nd Sec. (higher is better)

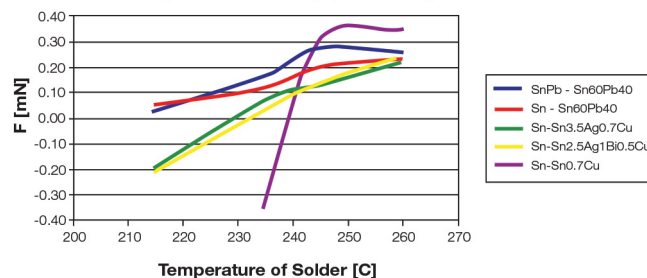

IMPORTANT NOTE: Typical Pb-Free reflow solders have a more dull and grainy appearance compared to traditional SnPb. Elevating the reflow temperature will not change this, but extending the cool down can help improve the visual appearance of the joint.

Recommended Soldering Profiles

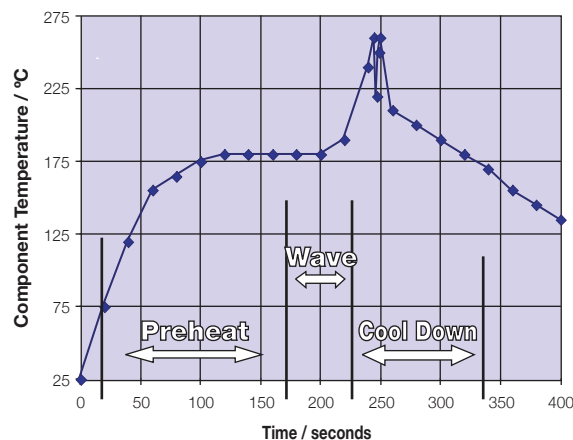

Surface Mounting Guide

MLC Chip Capacitors



APPLICATION NOTES

Storage

The components should be stored in their "as received packaging" where possible. If the components are removed from their original packaging then they should be stored in an airtight container (e.g. a heat sealed plastic bag) with desiccant (e.g. silica gel). Storage area temperature should be kept between +5 degrees C and +30 degrees C with humidity < 70% RH. Storage atmosphere must be free of gas containing sulfur and chlorine. Avoid exposing the product to saline moisture or to temperature changes that might result in the formation of condensation. To assure good solderability performance we recommend that the product be used within 6 months from our shipping date, but can be used for up to 12 months. Chip capacitors may crack if exposed to hydrogen (H₂) gas while sealed or if coated with silicon, which generates hydrogen gas.

Solderability

Terminations to be well soldered after immersion in a 60/40 tin/lead solder bath at 245°C +/- 5°C for 5 +0/-0.5 seconds.

Leaching

Terminations will resist leaching for at least the immersion times and conditions shown below.

| Termination Type | Solder Tin/ Lead/Silver | Solder Temp °C | Immersion Time Seconds |
|------------------|----------------------------|-------------------|---------------------------|
| Nickel Barrier | 60/40/0 | 260 ± 5 | 30 ± 1 |

Lead-Free Wave Soldering

The recommended peak temperature for lead-free wave soldering is 250°C-260°C for 3-5 seconds. The other parameters of the profile remains the same as above.

The following should be noted by customers changing from lead based systems to the new lead free pastes.

- The visual standards used for evaluation of solder joints will need to be modified as lead free joints are not as bright as with tin-lead pastes and the fillet may not be as large.
- Lead-free solder pastes do not allow the same self alignment as lead containing systems. Standard mounting pads are acceptable, but machine set up may need to be modified.

General

Surface mounting chip multilayer ceramic capacitors are designed for soldering to printed circuit boards or other substrates. The construction of the components is such that they will withstand the time/temperature profiles used in both wave and reflow soldering methods.

Handling

Chip multilayer ceramic capacitors should be handled with care to avoid damage or contamination from perspiration and skin oils. The use of tweezers or vacuum pick ups is strongly recommended for individual components. Bulk handling should ensure that abrasion and mechanical shock are minimized. Taped and reeled components provides the ideal medium for direct presentation to the placement machine. Any mechanical shock should be minimized during handling chip multilayer ceramic capacitors.

Preheat

It is important to avoid the possibility of thermal shock during soldering and carefully controlled preheat is therefore required. The rate of preheat should not exceed 4°C/second and a target figure 2°C/second is recommended. Although an 80°C to 120°C temperature differential is preferred, recent developments allow a temperature differential between the component surface and the soldering temperature of 150°C (Maximum) for capacitors of 1210 size and below with a maximum thickness of 1.25mm. The user is cautioned that the risk of thermal shock increases as chip size or temperature differential increases.

Soldering

Mildly activated rosin fluxes are preferred. The minimum amount of solder to give a good joint should be used. Excessive solder can lead to damage from the stresses caused by the difference in coefficients of expansion between solder, chip and substrate. AVX terminations are suitable for all wave and reflow soldering systems. If hand soldering cannot be avoided, the preferred technique is the utilization of hot air soldering tools.

Cooling

Natural cooling in air is preferred, as this minimizes stresses within the soldered joint. When forced air cooling is used, cooling rate should not exceed 4°C/second. Quenching is not recommended but if used, maximum temperature differentials should be observed according to the preheat conditions above.

Cleaning

Flux residues may be hygroscopic or acidic and must be removed. AVX MLC capacitors are acceptable for use with all of the solvents described in the specifications MIL-STD-202 and EIA-RS-198. Alcohol based solvents are acceptable and properly controlled water cleaning systems are also acceptable. Many other solvents have been proven successful, and most solvents that are acceptable to other components on circuit assemblies are equally acceptable for use with ceramic capacitors.

Prevention of Metallic Migration

Note that when components with Sn plating on the end terminations are to be used in applications that are likely to experience conditions of high humidity under bias voltage, we strongly recommend that the circuit boards be conformally coated to protect the Sn from moisture that might lead to migration and eventual current leakage.

When using Capacitor Arrays we recommend that there is no differential in applied voltage between adjacent elements.

Surface Mounting Guide

MLC Chip Capacitors

POST SOLDER HANDLING

Once SMP components are soldered to the board, any bending or flexure of the PCB applies stresses to the soldered joints of the components. For leaded devices, the stresses are absorbed by the compliancy of the metal leads and generally don't result in problems unless the stress is large enough to fracture the soldered connection.

Ceramic capacitors are more susceptible to such stress because they don't have compliant leads and are brittle in nature. The most frequent failure mode is low DC resistance or short circuit. The second failure mode is significant loss of capacitance due to severing of contact between sets of the internal electrodes.

Cracks caused by mechanical flexure are very easily identified and generally take one of the following two general forms:

Mechanical cracks are often hidden underneath the termination and are difficult to see externally. However, if one end termination falls off during the removal process from PCB, this is one indication that the cause of failure was excessive mechanical stress due to board warping.

COMMON CAUSES OF MECHANICAL CRACKING

The most common source for mechanical stress is board depanelization equipment, such as manual breakpart, v-cutters and shear presses. Improperly aligned or dull cutters may cause torquing of the PCB resulting in flex stresses being transmitted to components near the board edge. Another common source of flexural stress is contact during parametric testing when test points are probed. If the PCB is allowed to flex during the test cycle, nearby ceramic capacitors may be broken.

A third common source is board to board connections at vertical connectors where cables or other PCBs are connected to the PCB. If the board is not supported during the plug/unplug cycle, it may flex and cause damage to nearby components.

Special care should also be taken when handling large (>6" on a side) PCBs since they more easily flex or warp than smaller boards.

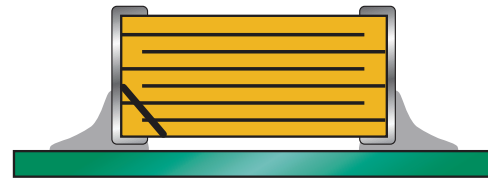

Type A:
Angled crack between bottom of device to top of solder joint.

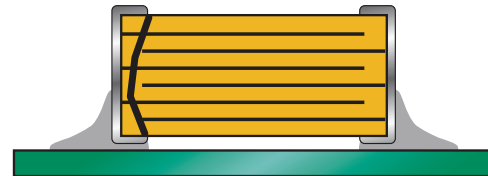

Type B:
Fracture from top of device to bottom of device.

REWORKING OF MLCs

Thermal shock is common in MLCs that are manually attached or reworked with a soldering iron. AVX strongly recommends that any reworking of MLCs be done with hot air reflow rather than soldering irons. It is practically impossible to cause any thermal shock in ceramic capacitors when using hot air reflow.

However direct contact by the soldering iron tip often causes thermal cracks that may fail at a later date. If rework by soldering iron is absolutely necessary, it is recommended that the wattage of the iron be less than 30 watts and the tip temperature be <300°C. Rework should be performed by applying the solder iron tip to the pad and not directly contacting any part of the ceramic capacitor.

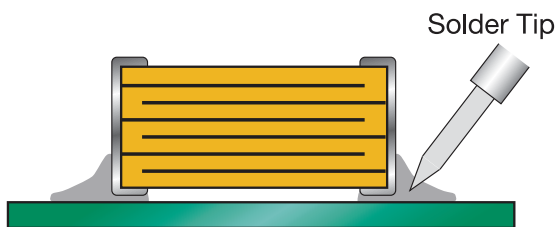

Preferred Method - No Direct Part Contact

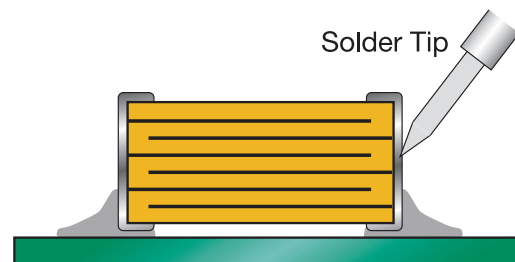

Poor Method - Direct Contact with Part

PCB BOARD DESIGN

To avoid many of the handling problems, AVX recommends that MLCs be located at least .2" away from nearest edge of board. However when this is not possible, AVX recommends that the panel be routed along the cut line, adjacent to where the MLC is located.

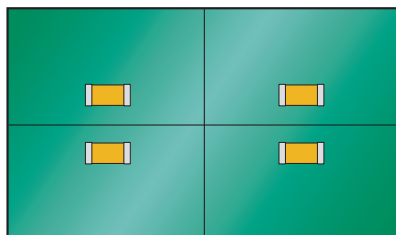

No Stress Relief for MLCs

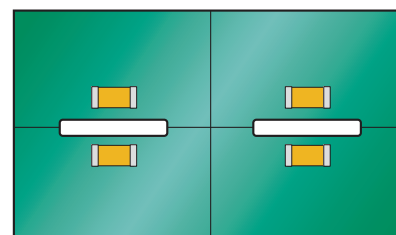

Routed Cut Line Relieves Stress on MLC

FOLLOW US:     

VISIT US AT WWW.AVX.COM 



North America

Tel: +1 864-967-2150

Europe

Tel: +44 1276-697000

Asia

Tel: +65 6286-7555

Central America

Tel: +55 11-46881960

Japan

Tel: +81 740-321250