



- Sealed to IP66 IP68 and IP69K when mated
- IP68 rating tested at 1.054kg/sq cm (15lb/sq in) 10m depth for 2 weeks
- Duplex LC-Type Interface
- Cabled Versions: 0S1, 0M1, 0M3
- Cable range from 5 to 450m
- Diameter over coupling ring 32.0mm
- Flex, Flex In-Line and Front Panel
- Secure, proven locking system
- 30° twist locking. Tamperproof lock prevents accidental un-mating
- All plastic body version; UL94-V0 rated, UV stable, halogen free Light-weight, self-extinguishing material suitable for long-term outdoor use.
- Sealing caps available to maintain IP68 rating
- EN60068-2-52 Test Kb Salt Mist (Cyclic) Marine Severity Level 1

CIRCULAR FIBER CONNECTORS
6000 Series - Duplex LC Fiber Buccaneer



Duplex LC Fiber



PXF6050XXX

- Patchcords with IP68 connectors
- Available in 5 - 450m lengths
- Supplied with LC fiber plug
- OS1, OM1 or OM3 cable options

*Fiber assignment on page 6

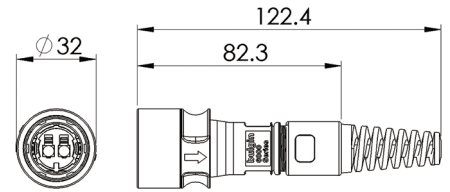

Duplex LC Fiber



PXF6051XXX

- Patchcords with IP68 connectors
- Available in 5 - 450m lengths
- Supplied with LC fiber plug
- OS1, OM1 or OM3 cable options

*Fiber assignment on page 6

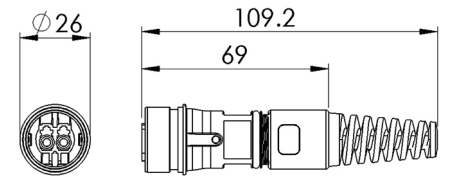

Duplex LC Fiber



PXF6054XXX

- Patchcords with IP68 connectors
- Available in 5 - 450m lengths
- Supplied with LC fiber plug
- OS1, OM1 or OM3 cable options

*Fiber assignment on page 6

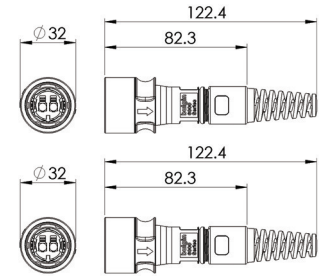

Duplex LC Fiber



PXF6055XXX

- Patchcords with IP68 connectors
- Available in 5 - 450m lengths
- Supplied with LC fiber plug
- OS1, OM1 or OM3 cable options

*Fiber assignment on page 6

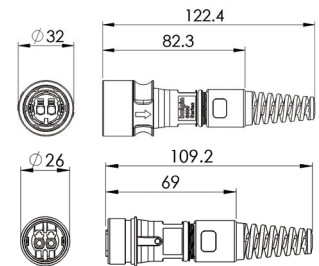

Front Panel Mounting Connector







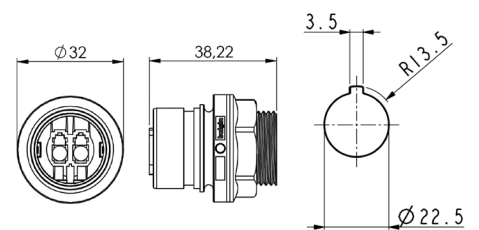

PXF6052XXX

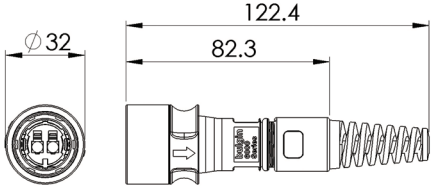
- LC fiber adapter
- Leaded with LC connector
- Socket variant mates with PXF6050 type connectors

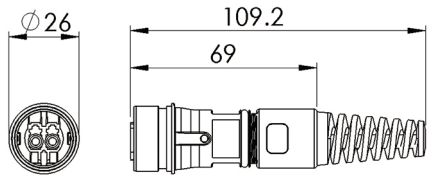
*Fiber assignment on page 6

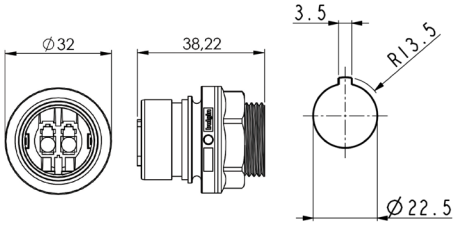

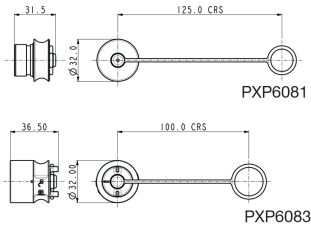
<p>Flex Cable Connector</p>  <p>PXF6050X</p>	<ul style="list-style-type: none"> ○ Mates with Flex In-Line or Panel mounting versions PXF6051, PXF6053 ○ 30° turn locking ring ○ Supplied without LC Connectors 	
<p>In-Line Flex Cable Connector</p>  <p>PXF6051X</p>	<ul style="list-style-type: none"> ○ Mates with Flex Cable connector PXF6050 ○ For In-Line connection ○ Supplied without LC Connectors 	
<p>Front Panel Mounting Connector</p>  <p>PXF6052X</p>	<ul style="list-style-type: none"> ○ Mates with Flex Cable connector PXF6050 ○ Rear Panel Mounting ○ Single hole fixing ○ Supplied without LC Connectors 	
<p>Sealing Caps</p> 	<ul style="list-style-type: none"> ○ Sealing caps to maintain IP rating when connectors are not in use ○ PXP6081 for cable connectors PXF6050. ○ PXP6083 for front panel mount connectors PXF6052 & PXF6051, with 30° twist lock 	

Part No.	Description
PXP6081	Sealing Cap for Flex cable connectors (PXF6050)
PXP6083	Sealing Cap for front panel mounting connector (PXF6052, PXF6051)

Cables & connectors

Mechanical

Sealing :	IP69K, DIN40050-9 IP68, EN60529:1992+A2:2013 (10m depth for 2 weeks) IP66, EN60529:1992+A2:2013 1.0-1.1Nm (91lb.in) -25°C to +70°C EN60068-2-52 Test Kb Salt Mist (Cyclic) Marine Severity Level 1
Panel Mount Nut:	1.0-1.1Nm (91lb.in)
Operating temperature:	-25°C to +70°C
Salt Mist:	EN60068-2-52 Test Kb Salt Mist (Cyclic) Marine Severity Level 1

Material:

Body Mouldings:	Polyamide
Flammability Rating:	UL94v-0
UV Resistance:	To EN 500021:1999
Cable Outer Jacket:	Polyethylene for UV and Weather Resistance
O Rings:	Silicone
Panel Sealing O Ring:	Silicone

Optical

IEC 61753-1:	
Max Insertion Loss:	0.2db } single mode
AVG Insertion Loss:	0.1db } single mode

RoHS Compliant

Fiber Specification - SECTION OSI

Item	Detail	Specification		
Fiber type:	/	G.657A2 (OS1)		
Mode field diameter:	Wavelength Dimension	1310mm 8.6µm-9.5µm±0.4µm		
Cladding diameter:	Dimension	125.0µm±0.7µm		
Core concentricity error:		≤0.5µm		
Cladding non-circularity:		≤1%		
Coating diameter:	Dimension	245µm±10µm		
Coating-cladding concentricity error:		≤12.5µm		
Cut-off wavelength:	Radius(mm)	≤1260nm		
Uncabled fiber macrobending loss:	Number of turns	15	10	7.5
	Max. at 1550nm(dB)	10	1	1
	Max. at 1625nm(dB)	0.03	0.1	0.5
Min. proof stress:		0.1	0.2	1.0
Dynamic fatigue parameter:		0.69GPa		
	λ0min	≥20		
Chromatic dispersion coefficient:	λ0max	1300nm		
	S0max	1324nm		
		0.092ps/nm2×km		
Other parameters meet standard:	ITU-T G.657			

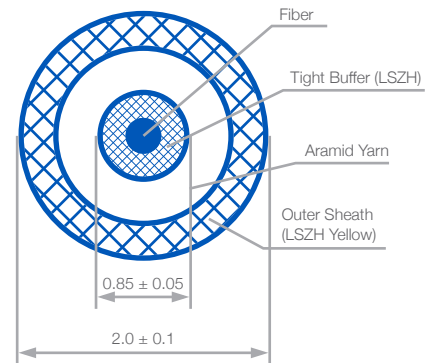

Optical Cable Specification

Structure Parameter

Tight buffer:	Material	Polyolefin (POE)
	Outer diameter	0.85mm±0.05mm
Strength member:	Material	Aramid yarn
Outer sheath:	Sheath material	Polyolefin (POE)
	Sheath color	Yellow(Pantone 136C) Chromatic aberration E: ≤4.0
	Min. sheath thickness	0.3mm
	Dimension	2.0mm±0.1mm

Transmission Performance

Attenuation coefficient:	Wavelength 1310nm~1625nm	≤0.4dB/km
	Maximum at 1383nm±3nm	≤0.4dB/km
	Wavelength 1550nm	≤0.3dB/km
Macrobending loss:	Radius(mm)	15 10 7.5
	Number of turns	10 1 1
	Max. at 1550nm(dB)	0.03 0.1 0.5
	Max. at 1625nm(dB)	0.1 0.2 1.0

Other performances

Min. bending radius of work	10mm
Other parameter meet standard	IEC60794-2-50, YD/T1258.2, ITU-T G.657

Fiber Specification - SECTION OMI

Item	Detail	Specification
Fiber type	/	62.5/125(A1b) (OM1)
Core diameter	Dimension	62.5μm±3μm
Cladding diameter	Dimension	125.0μm±2μm
Core-cladding concentricity error		≤3μm
Cladding non-circularity		≤2%
Core non-circularity		≤6%
Primary coating diameter (uncoloured)	Dimension	245μm±10μm
Primary coating-cladding		≤12.5μm
Concentricity error	Radius(mm)	37.5
Uncabled fiber macrobending loss	Number of turns At wavelengths 850nm and 1300nm(dB)	100 0.5
Min. proof stress		0.69GPa
Dynamic fatigue parameter		≥20
Minimum modal bandwidth- length Product for overfilled launch	Wavelength 850nm Wavelength 1300nm	200MHzkm 500MHzkm
Other parameters meet standard	IEC 60793-2-10	

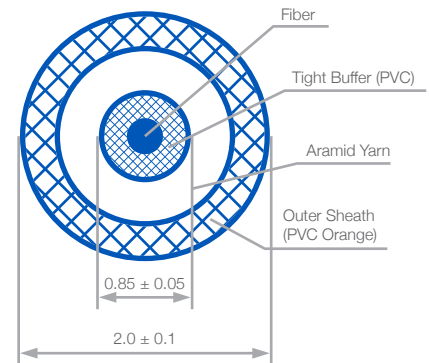

Optical Cable Specification

Item	Specification
Structure Parameter	
Tight buffer	Material: Polyolefin (POE) Outer diameter: 0.85mm±0.05mm
Strength member	Material: Aramid yarn
Outer sheath	Sheath material: Polyolefin (POE) Sheath color: Orange(Pantone 164C) Chromatic aberration E: ≤4.0 Min. sheath thickness: 0.3mm Dimension: 2.0mm±0.1mm
Transmission Performance	
Attenuation coefficient	Wavelength 850m: ≤3.5dB/km Wavelength 1300nm: ≤1.5dB/km
Other performances	
Min. bending radius of work	30mm
Other parameter meet standard	IEC60794-2-50, YD/T1258.2

Fiber Specification - SECTION OM3

Item	Detail	Specification
Fiber type	/	50/125(OM3)
Core diameter	Dimension	50 μm \pm 2.5 μm
Cladding diameter	Dimension	125.0 μm \pm 2 μm
Core-cladding concentricity error		\leq 3 μm
Cladding non-circularity		\leq 2%
Core non-circularity		\leq 6%
Primary coating diameter (uncoloured)	Dimension	245 μm \pm 10 μm
Primary coating-cladding concentricity error	Radius(mm)	15 7.5
Uncabled fiber macrobending loss	Number of turns Max. at 850nm(dB) Max. at 1300nm(dB)	2 2 0.1 0.2 0.3 0.5
Min. mode bandwidth	Overfilled launch bandwidth at 850nm Overfilled launch bandwidth at 1300nm Effective laser launch bandwidth at 850nm	1500 MHz. km 500 MHz. km 2000 MHz. km
Min. proof stress		0.69GPa
Dynamic fatigue parameter	λ 0min λ 0max	\leq 20 1295nm 1340nm
Chromatic dispersion coefficient	S0max(from1295nm $\leq\lambda$ 0 \leq 1310nm) S0max(from1310nm $\leq\lambda$ 0 \leq 1340nm)	0.105ps/nm ² ×km 0.000375(1590- λ) ps/nm ² ×km
Other parameters meet standard	IEC 60793-2-10	

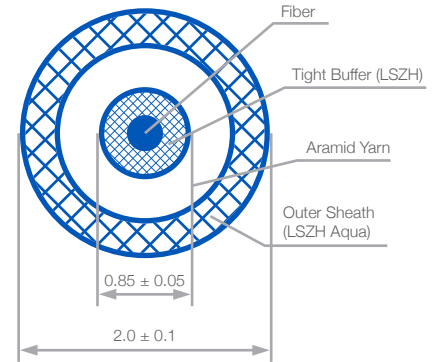

Optical Cable Specification

Item	Specification
Structure Parameter	
Tight buffer	Material: Polyolefin (POE) Outer diameter: 0.85mm \pm 0.05mm
Strength member	Material: Aramid yarn
Outer sheath	Sheath material: Polyolefin (POE) Sheath color: Aqua(Pantone 3248C) Chromatic aberration E: \leq 4.0 Min. sheath thickness: 0.3mm Dimension: 2.0mm \pm 0.1mm
Transmission Performance	
Attenuation coefficient	Wavelength 850m: \leq 3.5dB/km Wavelength 1300nm: \leq 1.5dB/km
Macrobending loss	Radius (mm): 15 7.5 Number of turns: 2 2 Max. at 850 nm (dB): 0.1 0.2 Max. at 1300 nm (dB): 0.3 0.5
Other performances	
Min. bending radius of work	10mm
Other parameter meet standard	IEC60794-2-50, YD/T1258.2

PXF605 X	X	XX
<p>Body Styles</p> <p>PXF6050 PXF6051 PXF6052 PXF6054 PXF6055</p>	<p>For Cable Type</p> <p>A = OM3 (Multimode) B = OM1 (Multimode) C = OS1 (Single Mode)</p>	<p>Cable Length</p> <p>Blank = No cable AA = 1 (1m on chassis version only PXF6052)</p> <p>AA = 5 AB = 10 AC = 15 AD = 25 AE = 50 AF = 100 AG = 150 AH = 200 AJ = 300 AK = 450</p>

Examples:

- PXF6050A = Flex connector, for OM3 (Multimode) no cable supplied
- PXF6050AAA = Flex connector, OM3 multimode cable, 5 metre length to LC type connector
- PXF6052BAA = Panel mount connector, OM1 multi mode cable, 1 metre length to LC type connector

Fiber Assignment:

