

Data sheet | Item number: 858-324

Relay module; Nominal input voltage: 24 VDC; 2 changeover contacts;
Limiting continuous current: 12 A; with manual operation; Red status
indicator; Module width: 31 mm; 1,50 mm²

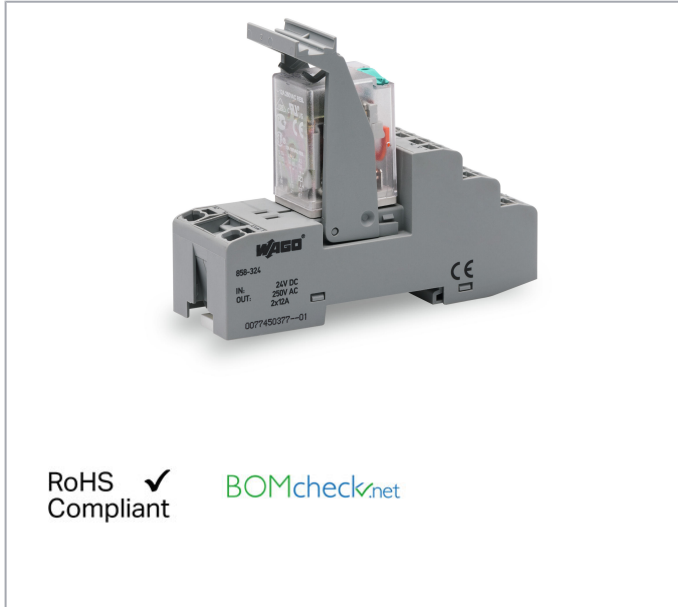

www.wago.com/858-324



RoHS
Compliant ✓

BOMcheck.net

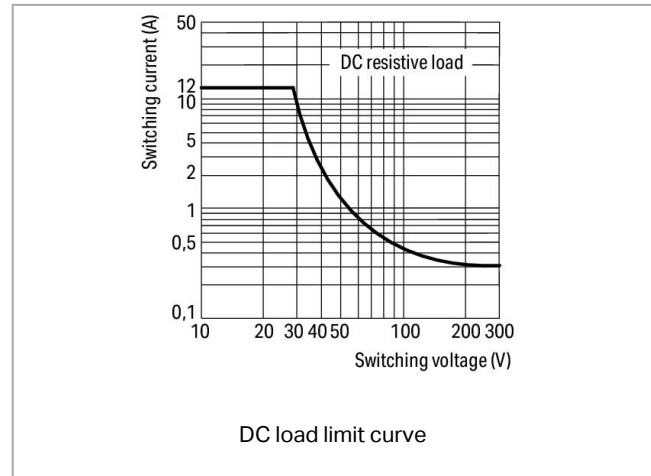
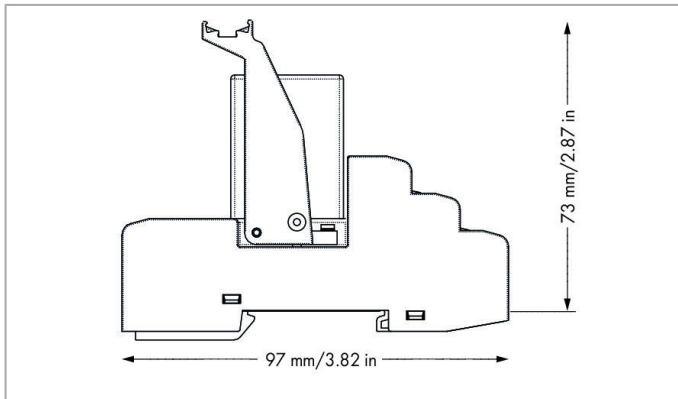
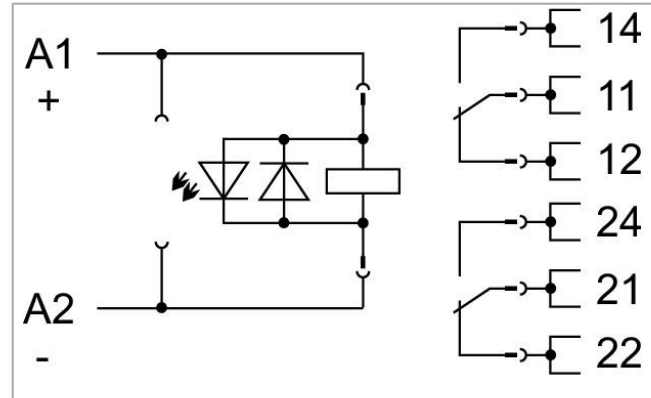

Data

Technical data

Control circuit

Nominal input voltage U_N

DC 24 V

Subject to changes. Please also observe the further product documentation!

WAGO Kontakttechnik GmbH & Co. KG

Hansastr. 27

32423 Minden

Phone: +49571 887-0 | Fax: +49571 887-169

Email: info.de@wago.com | Web: www.wago.com

Do you have any questions about our products?

We are always happy to take your call at +49 (571) 887-44222.

Input voltage range	-20 ... +10 %
Nominal input current at U_N	37.5 mA

Load circuit

Number of changeover/switchover contacts	2
Contact material (relay)	AgNi
Limiting continuous current	12 A
Inrush current (resistive) (max.)	(AC) 24 A / 4 s
Switching voltage (max.)	AC 250 V
Switching power (resistive) (max.)	AC 3000 VA; DC (see load limit curve)
Switching capacity	AC-15: 1.5 A / AC 240 V; DC-13: 0.1 A / DC 250 V
Recommended minimum load	10 V / 5 mA / 300 mW
Pull-in time (typ.)	13 ms
Drop-out time (typ.)	3 ms
Electrical life (NO; resistive load; 23 °C)	100 x 10 ³ switching operations
Mechanical life	20 x 10 ⁶ switching operations
Switching frequency with/without load (max.)	20 min ⁻¹ / 200 min ⁻¹

Signaling

Status indicator	Red LED Mechanical
------------------	-----------------------

Safety and protection

Rated voltage	250 V
Rated surge voltage	2.5 kV
Pollution degree	2
Dielectric strength, control/load circuit (AC, 1 min)	2.5 kVrms
Dielectric strength, open contact (AC, 1 min)	1.5 kVrms
Dielectric strength, load/load circuit (AC, 1 min)	2.5 kVrms
Protection type	IP20

Connection data

Connection technology	Push-in CAGE CLAMP®
Solid conductor	0.34 ... 1.5 mm ² / 22 ... 16 AWG
Fine-stranded conductor	0.34 ... 1.5 mm ² / 22 ... 16 AWG

Subject to changes. Please also observe the further product documentation!



Strip length	9 ... 10 mm / 0.35 ... 0.39 inch
Note (conductor cross-section)	2 x 0.34 ... 2 x 1.5 mm ² / 1 x 2.5 mm ² / 2 x 22 ... 2 x 16 AWG

Physical data

Width	31 mm / 1.22 inch
Height from upper-edge of DIN-rail	73 mm / 2.874 inch
Depth	97 mm / 3.819 inch

Mechanical data

Mounting type	DIN-35 rail
---------------	-------------

Material data

Weight	87.5 g
--------	--------

Environmental requirements

Surrounding air temperature (operation at U _N)	-40 ... 55 °C
Surrounding air temperature (storage)	-40 ... 85 °C
Processing temperature	-25 ... +50 °C

Standards and specifications

Standards/Specifications	EN 61010-2-201; EN 61810-1; UL 508
--------------------------	------------------------------------

Basic relay

WAGO Basic Relay	858-181
------------------	---------

Commercial data

Product Group	6 (Interface Electronics)
Packaging type	BOX
Country of origin	DE
GTIN	4055143567732
Customs tariff number	85364900990

Approvals / Certificates

UL-Approvals





Certificate

Subject to changes. Please also observe the further product documentation!

Logo	Approval	Additional Approval Text	name
	UL UL International Netherlands B.V. (ORDINARY LOCATIONS)	UL 508	E175199 Sec.6

Compatible products















General accessories

	Item no.: 209-145 Group marker carrier; white	www.wago.com/209-145
	Item no.: 209-184 Protection cover; transparent	www.wago.com/209-184
	Item no.: 788-120 Accessories for relay modules; Operation status indicator: red	www.wago.com/788-120
	Item no.: 858-110 Mounting bracket	www.wago.com/858-110

Marking accessories

	Item no.: 2009-110 Marking strips; for Smart Printer; on reel; not stretchable; plain; snap-on type; white	www.wago.com/2009-110
	Item no.: 2009-115 WMB-Inline; for Smart Printer; 1500 pieces on roll; stretchable 5 - 5.2 mm; plain; snap-on type; white	www.wago.com/2009-115
	Item no.: 2009-115/000-002 WMB-Inline; for Smart Printer; 1500 pieces on roll; stretchable 5 - 5.2 mm; plain; snap-on type; yellow	www.wago.com/2009-115/000-002
	Item no.: 2009-115/000-006 WMB-Inline; for Smart Printer; 1500 pieces on roll; stretchable 5 - 5.2 mm; plain; snap-on type; blue	www.wago.com/2009-115/000-006
	Item no.: 2009-115/000-007 WMB-Inline; for Smart Printer; 1500 pieces on roll; stretchable 5 - 5.2 mm; plain; snap-on type; gray	www.wago.com/2009-115/000-007
	Item no.: 2009-115/000-012 WMB-Inline; for Smart Printer; 1500 pieces on roll; stretchable 5 - 5.2 mm; plain; snap-on type; orange	www.wago.com/2009-115/000-012
	Item no.: 2009-115/000-017 WMB-Inline; for Smart Printer; 1500 pieces on roll; stretchable 5 - 5.2 mm; plain; snap-on type; light green	www.wago.com/2009-115/000-017
	Item no.: 2009-115/000-023 WMB-Inline; for Smart Printer; 1500 pieces on roll; stretchable 5 - 5.2 mm; plain; snap-on type; green	www.wago.com/2009-115/000-023

Subject to changes. Please also observe the further product documentation!

	Item no.: 2009-115/000-024 WMB-Inline; for Smart Printer; 1500 pieces on roll; stretchable 5 - 5.2 mm; plain; snap-on type; violet	www.wago.com/2009-115/000-024
	Item no.: 209-128 Adaptor; gray	www.wago.com/209-128
	Item no.: 209-183 Marker card; white	www.wago.com/209-183
	Item no.: 210-110 Fiber-tip pen	www.wago.com/210-110
	Item no.: 249-105 Group marker carrier; gray	www.wago.com/249-105
	Item no.: 793-501 WMB marking card; as card; not stretchable; plain; snap-on type; white	www.wago.com/793-501
	Item no.: 793-501/000-002 WMB marking card; as card; not stretchable; plain; snap-on type; yellow	www.wago.com/793-501/000-002
	Item no.: 793-501/000-005 WMB marking card; as card; not stretchable; plain; snap-on type; red	www.wago.com/793-501/000-005
	Item no.: 793-501/000-006 WMB marking card; as card; not stretchable; plain; snap-on type; blue	www.wago.com/793-501/000-006
	Item no.: 793-501/000-007 WMB marking card; as card; not stretchable; plain; snap-on type; gray	www.wago.com/793-501/000-007
	Item no.: 793-501/000-012 WMB marking card; as card; not stretchable; plain; snap-on type; orange	www.wago.com/793-501/000-012
	Item no.: 793-501/000-017 WMB marking card; as card; not stretchable; plain; snap-on type; light green	www.wago.com/793-501/000-017
	Item no.: 793-501/000-023 WMB marking card; as card; not stretchable; plain; snap-on type; green	www.wago.com/793-501/000-023
	Item no.: 793-501/000-024 WMB marking card; as card; not stretchable; plain; snap-on type; violet	www.wago.com/793-501/000-024
	Item no.: 793-502 WMB marking card; as card; MARKED; 1 ... 10 (10x); not stretchable; Horizontal marking; snap-on type;	www.wago.com/793-502

Subject to changes. Please also observe the further product documentation!



white

**Item no.: 793-502/000-002**

WMB marking card; as card; MARKED; 1 ... 10 (10x); not stretchable; Horizontal marking; snap-on type; yellow

www.wago.com/793-502/000-002**Item no.: 793-502/000-005**

WMB marking card; as card; MARKED; 1 ... 10 (10x); not stretchable; Horizontal marking; snap-on type; red

www.wago.com/793-502/000-005**Item no.: 793-502/000-006**

WMB marking card; as card; MARKED; 1 ... 10 (10x); not stretchable; Horizontal marking; snap-on type; blue

www.wago.com/793-502/000-006**Item no.: 793-502/000-007**

WMB marking card; as card; MARKED; 1 ... 10 (10x); not stretchable; Horizontal marking; snap-on type; gray

www.wago.com/793-502/000-007**Item no.: 793-502/000-012**

WMB marking card; as card; MARKED; 1 ... 10 (10x); not stretchable; Horizontal marking; snap-on type; orange

www.wago.com/793-502/000-012**Item no.: 793-502/000-017**

WMB marking card; as card; MARKED; 1 ... 10 (10x); not stretchable; Horizontal marking; snap-on type; light green

www.wago.com/793-502/000-017**Item no.: 793-502/000-023**

WMB marking card; as card; MARKED; 1 ... 10 (10x); not stretchable; Horizontal marking; snap-on type; green

www.wago.com/793-502/000-023**Item no.: 793-502/000-024**

WMB marking card; as card; MARKED; 1 ... 10 (10x); not stretchable; Horizontal marking; snap-on type; violet

www.wago.com/793-502/000-024**Item no.: 793-503**

WMB marking card; as card; MARKED; 11 ... 20 (10x); not stretchable; Horizontal marking; snap-on type; white

www.wago.com/793-503**Item no.: 793-503/000-002**

WMB marking card; as card; MARKED; 11 ... 20 (10x); not stretchable; Horizontal marking; snap-on type; yellow

www.wago.com/793-503/000-002**Item no.: 793-503/000-005**

WMB marking card; as card; MARKED; 11 ... 20 (10x); not stretchable; Horizontal marking; snap-on type; red

www.wago.com/793-503/000-005**Item no.: 793-503/000-006**

WMB marking card; as card; MARKED; 11 ... 20 (10x); not stretchable; Horizontal marking; snap-on type; blue

www.wago.com/793-503/000-006**Item no.: 793-503/000-007**

WMB marking card; as card; MARKED; 11 ... 20 (10x); not stretchable; Horizontal marking; snap-on type; gray

www.wago.com/793-503/000-007

Subject to changes. Please also observe the further product documentation!

WAGO Kontakttechnik GmbH & Co. KG

Hansastr. 27













32423 Minden

Phone: +49571 887-0 | Fax: +49571 887-169

Email: info.de@wago.com | Web: www.wago.com

Do you have any questions about our products?

We are always happy to take your call at +49 (571) 887-44222.

	Item no.: 793-503/000-012 WMB marking card; as card; MARKED; 11 ... 20 (10x); not stretchable; Horizontal marking; snap-on type; orange	www.wago.com/793-503/000-012
	Item no.: 793-503/000-017 WMB marking card; as card; MARKED; 11 ... 20 (10x); not stretchable; Horizontal marking; snap-on type; light green	www.wago.com/793-503/000-017
	Item no.: 793-503/000-023 WMB marking card; as card; MARKED; 11 ... 20 (10x); not stretchable; Horizontal marking; snap-on type; green	www.wago.com/793-503/000-023
	Item no.: 793-503/000-024 WMB marking card; as card; MARKED; 11 ... 20 (10x); not stretchable; Horizontal marking; snap-on type; violet	www.wago.com/793-503/000-024
	Item no.: 793-504 WMB marking card; as card; MARKED; 21 ... 30 (10x); not stretchable; Horizontal marking; snap-on type; white	www.wago.com/793-504
	Item no.: 793-504/000-002 WMB marking card; as card; MARKED; 21 ... 30 (10x); not stretchable; Horizontal marking; snap-on type; yellow	www.wago.com/793-504/000-002
	Item no.: 793-504/000-005 WMB marking card; as card; MARKED; 21 ... 30 (10x); not stretchable; Horizontal marking; snap-on type; red	www.wago.com/793-504/000-005
	Item no.: 793-504/000-006 WMB marking card; as card; MARKED; 21 ... 30 (10x); not stretchable; Horizontal marking; snap-on type; blue	www.wago.com/793-504/000-006
	Item no.: 793-504/000-012 WMB marking card; as card; MARKED; 21 ... 30 (10x); not stretchable; Horizontal marking; snap-on type; orange	www.wago.com/793-504/000-012
	Item no.: 793-504/000-017 WMB marking card; as card; MARKED; 21 ... 30 (10x); not stretchable; Horizontal marking; snap-on type; light green	www.wago.com/793-504/000-017
	Item no.: 793-504/000-023 WMB marking card; as card; MARKED; 21 ... 30 (10x); not stretchable; Horizontal marking; snap-on type; green	www.wago.com/793-504/000-023
	Item no.: 793-505 WMB marking card; as card; MARKED; 31 ... 40 (10x); not stretchable; Horizontal marking; snap-on type; white	www.wago.com/793-505
	Item no.: 793-505/000-005 WMB marking card; as card; MARKED; 31 ... 40 (10x); not stretchable; Horizontal marking; snap-on type; red	www.wago.com/793-505/000-005
	Item no.: 793-505/000-006	

Subject to changes. Please also observe the further product documentation!



WMB marking card; as card; MARKED; 31 ... 40 (10x); not stretchable; Horizontal marking; snap-on type; blue

www.wago.com/793-505/000-006



Item no.: 793-505/000-007

WMB marking card; as card; MARKED; 31 ... 40 (10x); not stretchable; Horizontal marking; snap-on type; gray

www.wago.com/793-505/000-007



Item no.: 793-505/000-012

WMB marking card; as card; MARKED; 31 ... 40 (10x); not stretchable; Horizontal marking; snap-on type; orange

www.wago.com/793-505/000-012



Item no.: 793-506

WMB marking card; as card; MARKED; 41 ... 50 (10x); not stretchable; Horizontal marking; snap-on type; white

www.wago.com/793-506



Item no.: 793-506/000-005

WMB marking card; as card; MARKED; 41 ... 50 (10x); not stretchable; Horizontal marking; snap-on type; red

www.wago.com/793-506/000-005



Item no.: 793-506/000-006

WMB marking card; as card; MARKED; 41 ... 50 (10x); not stretchable; Horizontal marking; snap-on type; blue

www.wago.com/793-506/000-006



Item no.: 793-506/000-012

WMB marking card; as card; MARKED; 41 ... 50 (10x); not stretchable; Horizontal marking; snap-on type; orange

www.wago.com/793-506/000-012



Item no.: 793-506/000-017

WMB marking card; as card; MARKED; 41 ... 50 (10x); not stretchable; Horizontal marking; snap-on type; light green

www.wago.com/793-506/000-017



Item no.: 793-5501

WMB marking card; as card; for terminal block width 5 - 17.5 mm; stretchable 5 - 5.2 mm; plain; snap-on type; white

www.wago.com/793-5501



Item no.: 793-5501/000-002

WMB marking card; as card; for terminal block width 5 - 17.5 mm; stretchable 5 - 5.2 mm; plain; snap-on type; yellow

www.wago.com/793-5501/000-002



Item no.: 793-5501/000-005

WMB marking card; as card; for terminal block width 5 - 17.5 mm; stretchable 5 - 5.2 mm; plain; snap-on type; red

www.wago.com/793-5501/000-005



Item no.: 793-5501/000-006

WMB marking card; as card; for terminal block width 5 - 17.5 mm; stretchable 5 - 5.2 mm; plain; snap-on type; blue

www.wago.com/793-5501/000-006



Item no.: 793-5501/000-007

WMB marking card; as card; for terminal block width 5 - 17.5 mm; stretchable 5 - 5.2 mm; plain; snap-on type; gray

www.wago.com/793-5501/000-007

Item no.: 793-5501/000-012

WMB marking card; as card; for terminal block width 5 - 17.5 mm; stretchable 5 - 5.2 mm; plain; snap-on

Subject to changes. Please also observe the further product documentation!

WAGO Kontakttechnik GmbH & Co. KG

Hansastr. 27

32423 Minden

Phone: +49571 887-0 | Fax: +49571 887-169

Email: info.de@wago.com | Web: www.wago.com

Do you have any questions about our products?

We are always happy to take your call at +49 (571) 887-44222.



type; orange

www.wago.com/793-5501/000-012
**Item no.: 793-5501/000-014**

WMB marking card; as card; for terminal block width 5 - 17.5 mm; stretchable 5 - 5.2 mm; plain; snap-on type; brown

www.wago.com/793-5501/000-014
**Item no.: 793-5501/000-017**

WMB marking card; as card; for terminal block width 5 - 17.5 mm; stretchable 5 - 5.2 mm; plain; snap-on type; green

www.wago.com/793-5501/000-017
**Item no.: 793-5501/000-023**

WMB marking card; as card; for terminal block width 5 - 17.5 mm; stretchable 5 - 5.2 mm; plain; snap-on type; light green

www.wago.com/793-5501/000-023
**Item no.: 793-5501/000-024**

WMB marking card; as card; for terminal block width 5 - 17.5 mm; stretchable 5 - 5.2 mm; plain; snap-on type; violet

www.wago.com/793-5501/000-024
**Item no.: 793-566**

WMB marking card; as card; MARKED; 1 ... 50 (2x); not stretchable; Horizontal marking; snap-on type; white

www.wago.com/793-566
**Item no.: 793-566/000-002**

WMB marking card; as card; MARKED; 1 ... 50 (2x); not stretchable; Horizontal marking; snap-on type; yellow

www.wago.com/793-566/000-002
**Item no.: 793-566/000-005**

WMB marking card; as card; MARKED; 1 ... 50 (2x); not stretchable; Horizontal marking; snap-on type; red

www.wago.com/793-566/000-005
**Item no.: 793-566/000-006**

WMB marking card; as card; MARKED; 1 ... 50 (2x); not stretchable; Horizontal marking; snap-on type; blue

www.wago.com/793-566/000-006
**Item no.: 793-566/000-007**

WMB marking card; as card; MARKED; 1 ... 50 (2x); not stretchable; Horizontal marking; snap-on type; gray

www.wago.com/793-566/000-007
**Item no.: 793-566/000-012**

WMB marking card; as card; MARKED; 1 ... 50 (2x); not stretchable; Horizontal marking; snap-on type; orange

www.wago.com/793-566/000-012
**Item no.: 793-566/000-017**

WMB marking card; as card; MARKED; 1 ... 50 (2x); not stretchable; Horizontal marking; snap-on type; light green

www.wago.com/793-566/000-017
**Item no.: 793-566/000-023**

WMB marking card; as card; MARKED; 1 ... 50 (2x); not stretchable; Horizontal marking; snap-on type; green

www.wago.com/793-566/000-023
Item no.: 793-566/000-024

Subject to changes. Please also observe the further product documentation!

WAGO Kontakttechnik GmbH & Co. KG

Hansastr. 27

32423 Minden

Phone: +49571 887-0 | Fax: +49571 887-169

Email: info.de@wago.com | Web: www.wago.com

Do you have any questions about our products?

We are always happy to take your call at +49 (571) 887-44222.



WMB marking card; as card; MARKED; 1 ... 50 (2x); not stretchable; Horizontal marking; snap-on type; violet

www.wago.com/793-566/000-024

ferrule



Item no.: 216-241

Ferrule; Sleeve for 0.5 mm² / 20 AWG; insulated; electro-tin plated; electrolytic copper; gastight crimped; acc. to DIN 46228, Part 4/09.90; white

www.wago.com/216-241



Item no.: 216-242

Ferrule; Sleeve for 0.75 mm² / 18 AWG; insulated; electro-tin plated; electrolytic copper; gastight crimped; acc. to DIN 46228, Part 4/09.90; gray

www.wago.com/216-242



Item no.: 216-243

Ferrule; Sleeve for 1 mm² / AWG 18; insulated; electro-tin plated; electrolytic copper; gastight crimped; acc. to DIN 46228, Part 4/09.90; red

www.wago.com/216-243



Item no.: 216-244

Ferrule; Sleeve for 1.5 mm² / AWG 16; insulated; electro-tin plated; electrolytic copper; gastight crimped; acc. to DIN 46228, Part 4/09.90; black

www.wago.com/216-244

tools



Item no.: 210-719

Operating tool; Blade: 2.5 x 0.4 mm; with a partially insulated shaft

www.wago.com/210-719

Jumper



Item no.: 858-402

Jumper

www.wago.com/858-402

Downloads

Documentation

Bid Text

858-324 docx - Datei	2019 Feb 20	docx 17.9 kB	Download
-------------------------	-------------	-----------------	----------

858-324 X81 - Datei	2019 Feb 19	xml 5.0 kB	Download
------------------------	-------------	---------------	----------

Instruction Leaflet

Stecksocket für Elementarrelais		pdf 2.6 MB	Download
---------------------------------	--	---------------	----------

Additional Information

Disposal; Electrical and electronic equipment, Packaging	V 1.0.0	pdf 265.8 kB	Download
--	---------	-----------------	----------

Subject to changes. Please also observe the further product documentation!

CAD/CAE-Data

CAE data

EPLAN Data Portal 858-324	URL	Download
WSCAD Universe 858-324	URL	Download
ZUKEN Portal 858-324	URL	Download

CAD data

2D/3D Models 858-324	URL	Download
----------------------	---------------------	--------------------------

Environmental Product Compliance

Compliance Search

Environmental Product Compliance 858-324	URL	Download
--	---------------------	--------------------------

Relay module; Nominal input voltage: 24 VDC; 2 changeover contacts; Limiting continuous current: 12 A; with manual operation; Red status indicator; Module width: 31 mm; 1,50 mm²

Installation Notes

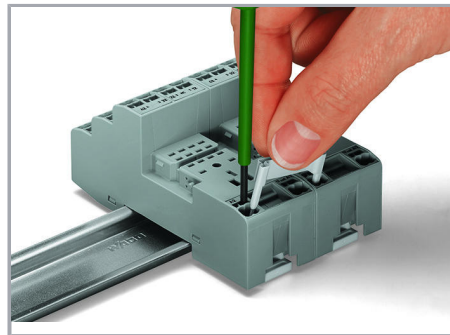
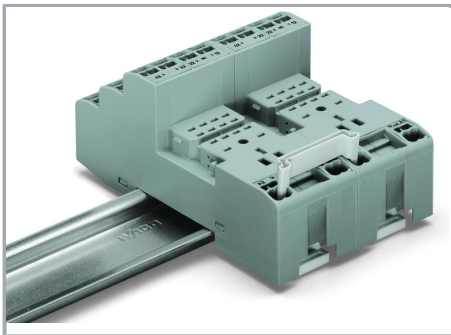

Remove jumper with screwdriver.

Marking

Subject to changes. Please also observe the further product documentation!

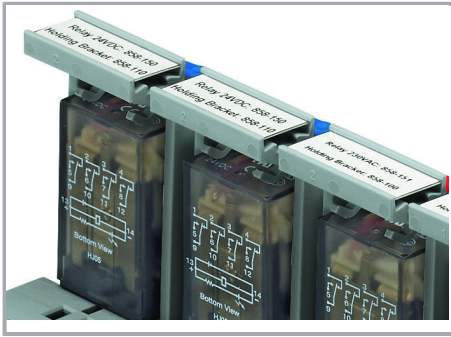

Marking using WMB Multi markers and group marker carriers

Subject to changes. Please also observe the further product documentation!