

## MAX20446C Evaluation Kit

Evaluates: MAX20446C

### General Description

The MAX20446C evaluation kit (EV kit) demonstrates the MAX20446C, an integrated 6-channel high-brightness LED driver with boost controller for automotive displays.

The EV kit operates from a DC supply voltage between 4.5V and 36V, and the switching frequency can be either set at 2.2MHz or at 400kHz. The EV kit operates in stand-alone mode. Spread-spectrum mode is enabled by default for EMI improvement. The EV kit demonstrates phase-shifted pulse-width modulation (PWM) dimming. Dimming can be performed externally using a PWM signal applied to the DIM PCB pad. The hybrid dimming feature can also be enabled through a resistor connected between the SET pin and GND to reduce EMI. The EV kit also demonstrates short-LED, open-LED, boost output undervoltage and overvoltage, and overtemperature-fault protection.

For operation at switching frequencies other than 2.2MHz or 400kHz, the external components should be chosen according to the calculations in the MAX20446C IC data sheet.

### Features

- Demonstrates Robustness of MAX20446C
- Wide 4.5V to 36V Input Operating Range (Up to 52V Load Dump)
- Powers HB LEDs (up to six strings) for Medium-to-Large-Sized LCD Displays in Automotive and Display Backlight Applications
- 400kHz to 2.2MHz Resistor-Programmable Switching Frequency with Spread-Spectrum Option
- Phase-Shift Dimming
- Demonstrates Cycle-by-Cycle Current Limit and Thermal-Shutdown Features
- Demonstrates Wide Dimming Ratio
- Proven PCB and Thermal Design
- Fully Assembled and Tested

**Ordering Information** appears at end of data sheet.

### Quick Start

#### Required Equipment

- MAX20446C EV kit
- 5V to 36V, 4A DC power supply
- Two digital voltmeters (DVMs)
- Six series-connected HB LED strings (6 LEDs each) rated to no less than 120mA
- Current probe to measure the HB LED current

#### Procedure

The EV kit is fully assembled and tested. Follow these steps to verify board operation.

**Caution: Do not turn on the power supply until all connections are completed.**

- 1) Verify that Jumper J17 is closed and that Jumper J22 is open (2.2MHz switching frequency selected).
- 2) Verify that Jumper J1 is closed (DS1 green LED connected).
- 3) Verify that Jumper J20 is closed (FAULT signaling enabled through DS2 red LED).
- 4) Verify that a shunt is installed across pins 1-2 on Jumper J2 (device enabled).
- 5) Verify that Jumpers JMP1–JMP3, JMP6–JMP7, and JMP9 have shunts installed across pins 1-2 (bleed resistors connected, all current sinks enabled).
- 6) Verify that a shunt is installed across pins 2-3 on Jumper J29 (LED short detection threshold set to 8V).
- 7) Verify that a shunt is installed across pins 2-3 on Jumper J30 (LED current range set to 85mA–120mA and hybrid dimming function disabled).
- 8) Verify that Jumper J8 is closed (LED current set to 100mA).
- 9) Connect the positive terminal of the power supply to the IN PCB pad. Connect the negative terminal of the power supply to a PGND PCB pad.
- 10) Connect a DVM across OUT1 and GND PCB pads.

- 11) Connect the six LED strings from  $V_{OUT}$  to the OUT1, OUT2, OUT3, OUT4, OUT5, and OUT6 PCB pads.
- 12) Clip the current probe across the channel 1 HB LED+ wire to measure the LED current.
- 13) Turn on the power supply and set it to 12V. The green LED (DS1) and the LED strings should be on at this point.
- 14) Measure the voltage from each of the OUT\_ PCB pads to PGND and verify the lowest voltage is approximately 1V.
- 15) Measure the LED current using the current probe and verify all channels.

### Detailed Description of Hardware

The MAX20446C EV kit demonstrates the MAX20446C HB LED driver with an integrated step-up DC-DC pre-regulator followed by six linear current sinks to drive up to six strings of LEDs. The pre-regulator switches at 2.2MHz (or at 400kHz) and operates as a current-mode controlled regulator, providing up to 720mA for the linear current sinks as well as overvoltage protection. The cycle-by-cycle current limit is set by resistor R27, while resistors R4 and R5 set the over-voltage protection level to 29V. The preregulator power section consists of inductor L2, power-sense resistor R27, Q4 MOSFET, and switching diode D1. The EV kit circuit operates from a 4.5V DC supply voltage up to the HB LED forward string voltage. The circuit handles load-dump conditions up to 50V.

The EV kit circuit demonstrates ultra-low shutdown current when the EN pin of the device is pulled to GND by shorting the EN PCB pad to GND. Each of the six linear current sinks (OUT1–OUT6) is capable of operating up to 48V, sinking up to 120mA per channel.

The six channels' linear current sinks are configured by selecting the current range through the SET pin (resistor values from 3.48kΩ to 27.4kΩ between SET and GND → Lower: 45mA-80mA/resistor values from 36.5kΩ to 75kΩ

between SET and GND or SET connected to  $V_{CC}$  → Higher: 85-120mA) and by setting the LED strings' current in steps of 5mA through a resistor connected between ISET pin and GND.

Jumpers JMP1–JMP3, JMP6–JMP7, and JMP9 can be used to disable outputs selectively when the HB LED string is not connected.

The EV kit features PCB pads to facilitate connecting HB LED strings for evaluation. The  $V_{OUT}$  PCB pads provide connections for connecting each HB LED string's anode to the DC-DC pre-regulator output. The OUT1–OUT6 PCB pads provide connections for connecting each HB LED string's cathode to the respective current sink. Capacitors C11, C14, C18, C23, C24, and C25 are included on the design to prevent oscillations and provide stability when using long, untwisted HB LED connecting cables during lab evaluation. These capacitors are not required if the connection between the LED driver and the HB LEDs is low-inductance.

A DIM PCB pad is provided for using a digital PWM signal to control the brightness of the HB LEDs. Test points are also provided for easy access to the device's  $V_{CC}$  regulator output as well as the COMP pin and the switching node of the pre-regulator (LX).

### Power LED Enable (J1)

A green LED (DS1) is used to indicate that the EV kit is powered on. The LED can be disconnected from the power supply, allowing precise current-consumption evaluation. See [Table 1](#) for shunt positions.

**Table 1. DS1 Enable (J1)**

SHUNT POSITION	DS1 POWER LED
Closed*	Connected
Open	Disconnected

\*Default position.

**Enable (EN)**

The EV kit features an enable input that can be used to enable/disable the device and place it in shutdown mode. To enable the EV kit whenever power is applied to IN, place the Jumper across pins 1-2 on Jumper J2. To enable the EV kit using an external enable signal, place the Jumper across pins 2-3 on J2 and apply a logic signal on the EN PCB input pad on the EV kit. A 1MΩ pulldown resistor on the EV kit pulls the EN input to GND in the event that J2 is left open or the EN signal is high impedance. Refer to the *Enable* section in the MAX20446C IC data sheet for additional information. See [Table 2](#) for J2 Jumper settings.

**Switching Frequency**

Jumpers J17 and J22 are used to set the switching frequency of the MAX20446C to either 2.2MHz or 400kHz. When J17 is closed and J22 is open, the switching frequency is set to 2.2MHz. When J17 is open and J22 is closed, the switching frequency is nominally 400kHz.

The EV kit is optimized for 2.2MHz switching operation by default. When selecting a switching frequency of 400kHz, L2 should be changed to 22μH to maintain acceptable

efficiency. Other component value adjustments may be needed.

Refer to the *Oscillator Frequency/External Synchronization* and *Spread-Spectrum Switching* sections in the MAX20446C IC data sheet for more information. See [Table 3](#) for J17 and J22 Jumper settings.

**HB LED Current**

The EV kit features Jumpers J3-J6, J8, J10, J12, and J14 to configure the device’s current sinks on all four channels. The low/high LED current range is selected through Jumpers J30, J7, J9, J11, J13, J15–J16, and J26–J28. See [Table 4](#) for proper Jumper settings to configure the current-sink limits.

The OUT\_ current value is directly related to the value of the resistor on the IREF pin. R<sub>IREF</sub> = 49.9kΩ (default value on the EV kit) allows the user to obtain a maximum full-scale value of 120mA. This value can be increased to 130mA by replacing R44 resistor with R<sub>IREF</sub> = 45.3kΩ; as a result, all the OUT\_ current values shown in [Table 4](#) will need to be proportionally scaled up.

**Table 2. Enable (J2)**

SHUNT POSITION	EN PIN	EV KIT OPERATION
1-2*	Connected to IN	Enabled when IN is powered
2-3	Connected to EN PCB pad	Enabled/disabled by signal on EN PCB pad

\*Default position.

**Table 3. Switching Frequency (J17 and J22)**

SHUNT POSITION		RT PIN	EV KIT OPERATION
J17	J22		
Closed*	Open*	RT connected to GND using a 13.3kΩ resistor	2.2MHz switching frequency
Open	Closed	RT connected to GND using a 76.8kΩ resistor	400kHz switching frequency

\*Default position.

**Table 4. LED Current (J3-J6, J8, J10, J12, and J14)**

SET CONFIGURATION	ISET RESISTOR VALUE	JUMPER	SHUNT POSITION	OUT_CURRENT
J30 shunted in 1-2 position and one among J9/J11/J13/J27/J28 closed → 45-80mA current range	3.48k	J14	Closed	45mA
	7.15k	J12	Closed	50mA
	12k	J10	Closed	55mA
	18.7k	J8	Closed	60mA
	27.4k	J6	Closed	65mA
	39k	J5	Closed	70mA
	59k	J4	Closed	75mA
	84.5k	J3	Closed	80mA
J30 shunted in 1-2 position and one among J7/J15/J16/J26 closed or J30 shunted in 2-3 position* → 85-120mA current range	3.48k	J14	Closed	85mA
	7.15k	J12	Closed	90mA
	12k	J10	Closed	95mA
	18.7k*	J8	Closed	100mA
	27.4k	J6	Closed	105mA
	39k	J5	Closed	110mA
	59k	J4	Closed	115mA
	84.5k	J3	Closed	120mA

\*Default position.

### Channel 1–Channel 6 Current-Sink Disabling

The EV kit features Jumpers JMP1–JMP3, JMP6–JMP7, and JMP9 which are used to put each OUT\_ current sink in one of three operating states:

- Normal operation, i.e., OUT\_ is connected to the corresponding ring on the board edge and LEDs are connected from there to the preregulator output V<sub>OUT</sub>
- OUT\_ connected through a 12kΩ resistor to GND, thus disabled
- OUT\_ shorted to GND, used to test fault detection

To disable a channel, install a Jumper in the channel's respective Jumper across pins 1-3, connecting the OUT\_ to GND through a 12kΩ resistor. The dimming algorithm in the IC requires that higher numbered OUT\_ current sinks be disabled first. For example, if only two strings are needed, OUT1–OUT2 should be used, with OUT3 to OUT6 disabled. See [Table 5](#) for Jumper settings. The 100kΩ bleed resistors are installed to prevent the OUT\_ leakage current from dimly turning on large LED strings even when the DIM signal is low.

### HB LED Digital Dimming Control

The EV kit features a DIM PCB input pad for connecting an external digital PWM signal. Apply a digital PWM signal with a 0.8V logic-low level (or less) and 2.1V logic-high

level (or greater). The DIM signal frequency should be at least 100Hz. If the DIM frequency is changed during operation, then the MAX20446C must be powered off and on again to register the change. To adjust the HB LED brightness, vary the signal duty cycle from 0% to 100% and maintain a minimum pulse width of 500ns. Apply the digital PWM signal to the DIM PCB pad. The DIM input of the IC is pulled up internally with a 5μA (typ.) current source.

For additional information on the device's digital dimming feature, refer to the *Dimming* section in the MAX20446C IC data sheet.

### Hybrid Dimming Operation

The hybrid dimming feature can be enabled by connecting a resistor from SET to GND. The resistor value, selectable through the same Jumpers used to set the low/high LED current range, will set the hybrid dimming threshold value and the device determines whether to dim the LED current by reducing or chopping it, depending on this threshold.

For additional information on the device's hybrid dimming feature, refer to the *Hybrid Dimming* section in the MAX20446C IC data sheet.

See [Table 6](#) for proper Jumper settings to enable the hybrid dimming function and to configure the hybrid dimming threshold.

**Table 5. Selecting OUT\_ Channels Operating State (JMP1–JMP3, JMP6–JMP7, and JMP9)**

OUT_	JUMPER	SHUNT POSITION	CHANNEL OPERATION
OUT1	JMP9	1-2*	Channel 1 operational; connect an HB LED string** between V <sub>OUT</sub> and OUT1. Bleed resistor connected.
		1-3	Channel 1 not used. OUT1 current sink disabled.
		1-4	Channel 1 shorted to GND to simulate a fault.
OUT2	JMP7	1-2*	Channel 2 operational; connect an HB LED string** between V <sub>OUT</sub> and OUT2. Bleed resistor connected.
		1-3	Channel 2 not used. OUT2 current sink disabled.
		1-4	Channel 2 shorted to GND to simulate a fault.
OUT3	JMP6	1-2*	Channel 3 operational; connect an HB LED string** between V <sub>OUT</sub> and OUT3. Bleed resistor connected.
		1-3	Channel 3 not used. OUT3 current sink disabled.
		1-4	Channel 3 shorted to GND to simulate a fault.
OUT4	JMP3	1-2*	Channel 4 operational; connect an HB LED string** between V <sub>OUT</sub> and OUT4. Bleed resistor connected.
		1-3	Channel 4 not used. OUT4 current sink disabled.
		1-4	Channel 4 shorted to GND to simulate a fault.
OUT5	JMP2	1-2*	Channel 5 operational; connect an HB LED string** between V <sub>OUT</sub> and OUT5. Bleed resistor connected.
		1-3	Channel 5 not used. OUT5 current sink disabled.
		1-4	Channel 5 shorted to GND to simulate a fault.
OUT6	JMP1	1-2*	Channel 6 operational; connect an HB LED string** between V <sub>OUT</sub> and OUT6. Bleed resistor connected.
		1-3	Channel 6 not used. OUT6 current sink disabled.
		1-4	Channel 6 shorted to GND to simulate a fault.

\*Default position.

\*\*The series-connected HB LED string must be rated to no less than 120mA.

**Table 6. LED Current (J30, J7, J9, J11, J13, J15–J16, and J26–J28)**

SET RESISTOR VALUE	JUMPER	SHUNT POSITION	HYBRID DIMMING THRESHOLD	
3.48k	J30 shunted in 1-2 position	J13	Closed	Hybrid dimming disabled
8.2k		J28	Closed	50% of peak LED current
14k		J27	Closed	25% of peak LED current
21.5k		J11	Closed	12.5% of peak LED current
27.4k		J9	Closed	6.25% of peak LED current
36.5k		J26	Closed	50% of peak LED current
47k		J16	Closed	25% of peak LED current
59k		J7	Closed	12.5% of peak LED current
75k		J15	Closed	6.25% of peak LED current
SET shorted to VCC*	J30 shunted in 2-3 position			Hybrid dimming disabled

\*Default position.

### Fault-Indicator Output ( $\overline{\text{FLT}}$ )

The EV kit features the device's open-drain  $\overline{\text{FLT}}$  output. The  $\overline{\text{FLT}}$  signal is pulled up to  $V_{\text{CC}}$  by resistor R48.  $\overline{\text{FLT}}$  goes low when an open-LED or shorted-LED string is detected, during thermal warning/shutdown, or during boost undervoltage/overvoltage events. Keep Jumper J20 closed to allow DS2 red LED enabling in case  $\overline{\text{FLT}}$  goes low. Refer to the *Fault Protection* section in the MAX20446C IC data sheet for additional information on the  $\overline{\text{FLT}}$  signal.

### Shorted-LED Detection and Protection

In stand-alone mode, the short-LED threshold is programmed through the RSDT input. R40 and R41 form a resistor-divider from  $V_{\text{CC}}$  to RSDT to SGND. A shorted LED is detected when the following condition is satisfied:

$$V_{\text{OUT\_}} > 4 \times V_{\text{RSDT}}$$

When the short-LED threshold is reached, the affected current sink is disabled to reduce excess power dissipation and the  $\overline{\text{FLT}}$  indicator asserts low. The short-LED detection feature is regulated through Jumper J29. See [Table 7](#) for Jumper settings.

**Table 7. Short-LED Detection (J29)**

SHUNT POSITION	RSDT PIN	EV KIT OPERATION
1-2*	Connected to $V_{\text{CC}}$	Short-LED detection disabled
1-3	Connected to R40/R41 resistor divider	Short-LED detection regulated via resistor divider

\*Default position.

### Ordering Information

PART	TYPE
MAX20446CEVKIT#	EV KIT

#Denotes RoHS compliance.

### Overvoltage Detection and Protection

The resistors (R4 and R5) connected to BSTMON are configured for a  $V_{\text{OUT\_OVP}}$  of 29V. This sets the maximum converter output ( $\overline{V_{\text{OUT}}}$ ) voltage at 29V. During an open-LED string condition, the converter output ramps up to the output overvoltage threshold. Capacitor C3 can be added to provide noise filtering to the overvoltage signal. To reconfigure the circuit for a different voltage, replace resistor R4 with a different value using the following equation:

$$R4 = [(V_{\text{OUT\_OVP}}/1.23) - 1] \times R5$$

where R5 is 10k $\Omega$ ,  $V_{\text{OUT\_OVP}}$  is the overvoltage-protection threshold desired, and R4 is the new resistor value for obtaining the desired overvoltage protection. MOSFET Q1 is an optional over-voltage protection resistor-divider disconnect switch for ultra-low shutdown current.

Refer to the *Open-LED Management and Overvoltage Protection* section in the MAX20446C IC data sheet for additional information.

MAX20446C EV Kit Bill of Materials

ITEM	REF_DES	DNI/DNP	QTY	MFG PART #	MANUFACTURER	VALUE	DESCRIPTION	COMMENTS
1	C2, C6, C16	-	3	UMK107B1105KA; C1608X5R1H105K080AB; CL10A105K8BNNN; GRM188R61H105KAAL	TAYO YUDEN;TDK;SAMSUNG;MURATA	1UF	CAP: SMT (0603); 1UF; 10%; 50V; X5R; CERAMIC	
2	C4	-	1	C1608X7S2A104K080AB	TDK	0.1UF	CAP: SMT (0603); 0.1UF; 10%; 100V; X7S; CERAMIC	
3	C5, C26	-	2	C1210C475K5RAC; GRM32ER71H475KA88; CNC08P1X7R1H475K250AE	KEMET;MURATA;TDK	4.7UF	CAP: SMT (1210); 4.7UF; 10%; 50V; X7R; CERAMIC	
4	C9, C10	-	2	EEE-TG1H470UP	PANASONIC	47UF	CAP: SMT (CASE_F); 47UF; 20%; 50V; ALUMINUM-ELECTROLYTIC	
5	C11, C12, C14, C18, C23-C25	-	7	GRM1885C1H102JA01; C1608COG1H102J080AA; GCM1885C1H102JA16	MURATA;TDK;MURATA	1000PF	CAP: SMT (0603); 1000PF; 5%; 50V; COG; CERAMIC	
6	C13	-	1	C0603C473K5RAC; GRM188R71H473KA61; GCM188R71H473KA55; CGA3E2X7R1H473K080AA	KEMET;MURATA;MURATA;TDK	0.047UF	CAP: SMT (0603); 0.047UF; 10%; 50V; X7R; CERAMIC	
7	C17	-	1	CGA3E2C0G1H100D080AA	TDK	10PF	CAP: SMT (0603); 10PF; +0.50PF; 50V; COG; CERAMIC; AUTO	
8	C20	-	1	GRM188R71A225KE15; CL10B225KP8NNN; C1608X7R1A225K080AC; C0603C225K5RAC	MURATA;SAMSUNG;TDK;KEMET	2.2UF	CAP: SMT (0603); 2.2UF; 10%; 10V; X7R; CERAMIC	
9	C21	-	1	GRM1885C1H222JA01	MURATA	2200PF	CAP: SMT (0603); 2200PF; 5%; 50V; COG; CERAMIC	
10	C22	-	1	C0603C083J5RAC; C0603X83J5RAC	KEMET;KEMET	0.068UF	CAP: SMT (0603); 0.068UF; 5%; 50V; X7R; CERAMIC	
11	C27	-	1	06035C101JAT	AVX	100PF	CAP: SMT (0603); 100PF; 5%; 50V; X7R; CERAMIC	
12	C28	-	1	06035C220JAT	AVX	22PF	CAP: SMT (0603); 22PF; 5%; 50V; X7R; CERAMIC	
13	C30	-	1	GRM188R71C103KA01; ECJ-1VB1C10;CL10B103K08NNN; GCJ188R71C103KA01	MURATA;PANASONIC;SAMSUNG;MURATA	0.01UF	CAP: SMT (0603); 0.01UF; 10%; 16V; X7R; CERAMIC	
14	C226	-	1	C2012X7R1H225K125AC	TDK	2.2UF	CAP: SMT (0805); 2.2UF; 10%; 50V; X7R; CERAMIC	
15	COMP, LX, TP1, TP2, VCC	-	5	5011	N/A	5011	TEST POINT; PIN DIA=0.125IN; TOTAL LENGTH=0.445IN; BOARD HOLE=0.063IN; BLACK; PHOSPHOR BRONZE WIRE SILVER PLATE FINISH;	
16	D1	-	1	NRVBS260T3G	ON SEMICONDUCTOR	NRVBS260T3G	DIODE: SCH; SURFACE MOUNT SCHOTTKY POWER RECTIFIER; SMB; PIV=60V; IF=2A	
17	D2, D3	-	2	BZG03C18	VISHAY SEMICONDUCTORS	18V	DIODE: ZNR; SMT (DO-214AC); VZ=18V; IZM=0.025A	
18	D4	-	1	B160B-13-F	DIODES INCORPORATED	B160B-13-F	DIODE: SCH; SMB (DO-214AA); PIV=60V; IF=1A	
19	D5	-	1	CMPD914E	CENTRAL SEMICONDUCTOR	CMPD914E	DIODE: SWT; SMT (SOT23-3); PIV=150V; IF=0.1A	
20	DM, EN, FLT, GND, GND1, GND2, IN, OUT1-OUT6, PGND, PGND1, PGND2, RSDT, SYNC, VOUT, VOUT1-VOUT3	-	22	9020 BUSS	WEICO WIRE	MAXIMPAD	EVK KIT PARTS: MAXIM PAD, WIRE; NATURAL; SOLID; WEICO WIRE; SOFT DRAWN BUS TYPE-S; 20AWG	
21	DS1	-	1	LGL29K-F2J1-24-Z	OSRAM	LGL29K-F2J1-24-Z	DIODE: LED; SMARTLED; GREEN; SMT; PIV=1.7V; IF=0.02A	
22	DS2	-	1	LS L29K-G1J2-1-Z	OSRAM	LS L29K-G1J2-1-Z	DIODE: LED; SMART; RED; SMT (0603); PIV=1.8V; IF=0.02A; -40 DEGC TO +100 DEGC	
23	J1, J3-J17, J20, J22, J26-J28	-	21	PBC02SAAN	SULLINS ELECTRONICS CORP.	PBC02SAAN	CONNECTOR; MALE; THROUGH HOLE; BREAKAWAY; STRAIGHT; 2PINS	
24	J2, J29, J30	-	3	PEC03SAAN	SULLINS	PEC03SAAN	CONNECTOR; MALE; THROUGH HOLE; BREAKAWAY; STRAIGHT; 3PINS	
25	J25	-	1	HTSW-112-11-G-S-RA	SAMTEC	HTSW-112-11-G-S-RA	CONNECTOR; MALE; THROUGH HOLE; SQUARE POST HEADER; RIGHT ANGLE; 12PINS	
26	JMP1-JMP3, JMP6, JMP7, JMP9	-	6	PEC04SAAN	SULLINS ELECTRONICS CORP.	PEC04SAAN	CONNECTOR; MALE; THROUGH HOLE; BREAKAWAY; STRAIGHT; 4PINS	
27	L1	-	1	XAL4020-601ME	COILCRAFT	0.60UH	INDUCTOR; SMT; CORE MATERIAL= COMPOSITE; 0.60UH; TOL=+/-20%; 11.7A	
28	L2	-	1	MSS1246T-472ML	COILCRAFT	4.7UH	INDUCTOR; SMT; FERRITE CORE; 4.7UH; TOL=+/-20%; 9.70A	
29	MH1-MH4	-	4	9032	KEYSTONE	9032	MACHINE FABRICATED; ROUND; THRU HOLE SPACER; NO THREAD; M3.5; 5/8IN; NYLON	
30	Q1	-	1	NDS351AN	FAIRCHILD SEMICONDUCTOR	NDS351AN	TRAN; N-CHANNEL LOGIC LEVEL ENHANCEMENT MODE FIELD EFFECT TRANSISTOR; NCH; SUPERSOT-3; PD-(0.5W); I(-1.4A); V(-30V)	
31	Q2	-	1	MMBT3906-7-F	DIODES INCORPORATED	MMBT3906-7-F	TRAN; 40V PNP SMALL SIGNAL TRANSISTOR; PNP; SOT-23; PD-(0.31W); I(-0.2A); V(-40V)	
32	Q3	-	1	SUM55P06-19L-E3	VISHAY SILICONIX	SUM55P06-19L-E3	TRAN; P-CHANNEL 60V D-S ENHANCEMENT MODE MOSFET; PCH; TO-263-3; PD-(3.75W); I(-55A); V(-60V)	
33	Q4	-	1	NTMFS5C673NLT1G	ON SEMICONDUCTOR	NTMFS5C673NLT1G	TRAN; NCH; MOSFET; SO-8FL; PD-(46W); I(50A); V(-60V)	
34	Q5	-	1	SI1317DL-T1-GE3	VISHAY SILICONIX	SI1317DL-T1-GE3	TRAN; P-CHANNEL 20V (D-S) MOSFET; PCH; SOT-323; PD-(0.5W); I(-1.4A); V(-20V)	
35	R2	-	1	CRCW06033K00FK	VISHAY DALE	3K	RES; SMT (0603); 3K; 1%; +/-100PPM/DEGC; 0.1000W	

MAX20446C EV Kit Bill of Materials (continued)

ITEM	REF_DES	DNI/DNP	QTY	MFG PART #	MANUFACTURER	VALUE	DESCRIPTION	COMMENTS
36	R3, R7	-	2	CRCW08050000ZS,RC2012J000	DIGI-KEY	0	RES; SMT (0805); 0; JUMPER; JUMPER; 0.1250W	
37	R4	-	1	CRCW0805226KFK	VISHAY DALE	226K	RES; SMT (0805); 226K; 1%; +/-100PPM/DEGC; 0.1250W	
38	R5	-	1	TNPW080510K0BE,ERA-6YEB103V	VISHAY DALE;PANASONIC	10K	RES; SMT (0805); 10K; 0.10%; +/-25PPM/DEGC; 0.1250W	
39	R6	-	1	301-10K-RC	XICON	10K	RES; SMT (0603); 10K; 5%; +/-200PPM/DEGC; 0.0630W	
40	R8	-	1	CRCW12060000ZS;ERJ-8GEY0R00	VISHAY DALE;PANASONIC	0	RES; SMT (1206); 0; JUMPER; JUMPER; 0.2500W	
41	R9	-	1	CRCW06031M00FK;MCR03EZPF1004	VISHAY DALE;ROHM	1M	RES; SMT (0603); 1M; 1%; +/-100PPM/DEGC; 0.1000W	
42	R10, R17, R23, R34, R37, R43	-	6	CRCW0603100KFK;RC0603FR-07100KL;RC0603FR-13100KL;ERJ-3EKF1003;AC0603FR-07100KL	VISHAY DALE;YAGEO;YAGEO;PANASONIC	100K	RES; SMT (0603); 100K; 1%; +/-100PPM/DEGC; 0.1000W	
43	R11	-	1	CRCW060318K0FK	VISHAY DALE	18K	RES; SMT (0603); 18K; 1%; +/-100PPM/DEGC; 0.1000W	
44	R12, R19, R22, R29, R36, R38, R45	-	7	CRCW060312K0FK	VISHAY DALE	12K	RES; SMT (0603); 12K; 1%; +/-100PPM/DEGC; 0.1000W	
45	R13	-	1	RC0603FR-0784K5L	YAGEO PHYCOMP	84.5K	RES; SMT (0603); 84.5K; 1%; +/-100PPM/DEGC; 0.1000W	
46	R14	-	1	ERJ-8CWF0R050	PANASONIC	0.05	RES; SMT (1206); 0.05; 1%; +/-75PPM/DEGC; 1W	
47	R15, R49	-	2	CRCW06031K00FK;ERJ-3EKF1001;CR0603AFX-1001ELF	VISHAY; PANASONIC;BOURNS	1K	RES; SMT (0603); 1K; 1%; +/-100PPM/DEGC; 0.1000W	
48	R16, R53	-	2	ERJ-3EKF5902	PANASONIC	59K	RES; SMT (0603); 59K; 1%; +/-100PPM/DEGC; 0.1000W	
49	R18, R21	-	2	CRCW060327K4FK;ERJ-3EKF2742	VISHAY DALE;PANASONIC	27.4K	RES; SMT (0603); 27.4K; 1%; +/-100PPM/DEGC; 0.1000W	
50	R20	-	1	ERJ-3EKF187Z;CRCW060318K7FK	PANASONIC;VISHAY	18.7K	RES; SMT (0603); 18.7K; 1%; +/-100PPM/DEGC; 0.1000W	
51	R24	-	1	CRCW06033K74FK	VISHAY DALE	3.74K	RES; SMT (0603); 3.74K; 1%; +/-100PPM/DEGC; 0.1000W	
52	R25	-	1	ERJ-3EKF7502	PANASONIC	75K	RES; SMT (0603); 75K; 1%; +/-100PPM/DEGC; 0.1000W	
53	R26	-	1	CRCW060310R0FK;MCR03EZPF10R0;ERJ-3EKF10R0	VISHAY DALE;ROHM	10	RES; SMT (0603); 10; 1%; +/-100PPM/DEGC; 0.1000W	
54	R27	-	1	WSL1206R0400F		0.04	RES; SMT (1206); 0.04; 1%; +/-75PPM/DEGC; 0.2500W	
55	R28	-	1	ERJ-3EKF7151	PANASONIC	7.15K	RES; SMT (0603); 7.15K; 1%; +/-100PPM/DEGC; 0.1000W	
56	R30, R54	-	2	ERJ-3EKF3481	PANASONIC	3.48K	RES; SMT (0603); 3.48K; 1%; +/-100PPM/DEGC; 0.1000W	
57	R32	-	1	CRCW060339K0FK	VISHAY DALE	39K	RES; SMT (0603); 39K; 1%; +/-100PPM/DEGC; 0.1000W	
58	R35	-	1	CRCW06038K06FK;ERJ-3EKF8061	VISHAY DALE;PANASONIC	8.06K	RES; SMT (0603); 8.06K; 1%; +/-100PPM/DEGC; 0.1000W	
59	R39	-	1	CRCW060376K8FK	VISHAY DALE	76.8K	RES; SMT (0603); 76.8K; 1%; +/-100PPM/DEGC; 0.1000W	
60	R40	-	1	CRCW06033012FK	VISHAY DALE	30.1K	RES; SMT (0603); 30.1K; 1%; +/-100PPM/DEGC; 0.1000W	
61	R41	-	1	MCR03EZPF2002;ERJ-3EKF2002;CR0603-FX-2002ELF;CRCW060320K0FK	ROHM;PANASONIC;BOURNS;VISHAY DALE	20K	RES; SMT (0603); 20K; 1%; +/-100PPM/DEGC; 0.1000W	
62	R42, R48, R55	-	3	CHPHT0603K1002FGT	VISHAY SFERNICE	10K	RES; SMT (0603); 10K; 1%; +/-100PPM/DEGC; 0.0125W	
63	R44	-	1	CRCW060349K9FK;ERJ-3EKF4992	VISHAY DALE;PANASONIC	49.9K	RES; SMT (0603); 49.9K; 1%; +/-100PPM/DEGC; 0.1000W	
64	R50	-	1	CRCW060347K0FK	VISHAY DALE	47K	RES; SMT (0603); 47K; 1%; +/-100PPM/DEGC; 0.1000W	
65	R51	-	1	RN73C1J10RBTG; 1614350-2	TE CONNECTIVITY;TE CONNECTIVITY	10	RES; SMT (0603); 10; 0.10%; +/-10PPM/DEGC; 0.0630W	
66	R52	-	1	CRCW060313K3FK;ERJ-3EKF1332	VISHAY DALE;PANASONIC	13.3K	RES; SMT (0603); 13.3K; 1%; +/-100PPM/DEGC; 0.1000W	
67	R56	-	1	ERJ-3EKF365Z;CRCW060336K5FK	PANASONIC;VISHAY	36.5K	RES; SMT (0603); 36.5K; 1%; +/-100PPM/DEGC; 0.1000W	
68	R57	-	1	CRCW060321K5FK	VISHAY DALE	21.5K	RES; SMT (0603); 21.5K; 1%; +/-100PPM/DEGC; 0.1000W	
69	R58	-	1	ERJ-3EKF140Z;CRCW060314K0FK	PANASONIC;VISHAY	14K	RES; SMT (0603); 14K; 1%; +/-100PPM/DEGC; 0.1000W	
70	R59	-	1	CRCW06038K20FK	VISHAY DALE	8.2K	RES; SMT (0603); 8.2K; 1%; +/-100PPM/DEGC; 0.1000W	
71	U1	-	1	MAX20446CATGA/+	MAXIM	MAX20446CATGA/+	EVKIT PART - IC; DRV; AUTOMOTIVE 6-CHANNEL BACKLIGHT DRIVER WITH BOOST/ SEPIC CONTROLLER AND HYBRID DIMMING; PACKAGE OUTLINE DRAWING: 21-0139; LAND PATTERN NUMBER: 90-0022; PACKAGE CODE: T2444-4C; TOFN24-EP	
72	PCB	-	1	MAX20446C	MAXIM	PCB	PCB:MAX20446C	
73	C1, C19, C3	DNP	0	N/A	N/A	OPEN	CAPACITOR; SMT (0603); OPEN; FORMFACTOR	
74	C7, C8	DNP	0	C1210C475K5RAC;GRM32ER71H475KAB8;CNC6P1X7R1H475K250AE	KEMET;MURATA;TDK	4.7UF	CAP; SMT (1210); 4.7UF; 10%; 50V; X7R; CERAMIC	
75	C15	DNP	0	UMK107B1105KA;C1603XR1H105K080AB;CL10A105KB8NNN;GRM188R61H105KAAL	TAIYO YUDEN;TDK;SAMSUNG;MURATA	1UF	CAP; SMT (0603); 1UF; 10%; 50V; X5R; CERAMIC	
76	R1, R33, R31	DNP	0	N/A	N/A	OPEN	RESISTOR; 0603; OPEN; FORMFACTOR	
77	C29, C31	DNP	0	N/A	N/A	OPEN	EVKIT USE ONLY;DUAL PACKAGE OUTLINE 0603 AND 0805 NON-POLAR CAPACITOR	
TOTAL			156					



MAX20446C EV Kit Schematics

**MECHANICAL**

**MOUNTING HOLE**

**PLEASE SELECT ONE**



The diagram shows four circular mounting hole symbols arranged horizontally. Each symbol consists of a circle with a small circle inside it, and a vertical line passing through the center. Above each symbol is a label: MH1, MH2, MH3, and MH4. Below each symbol is the text 'MTHOLE'.

MAX20446C EV Kit Schematics (continued)

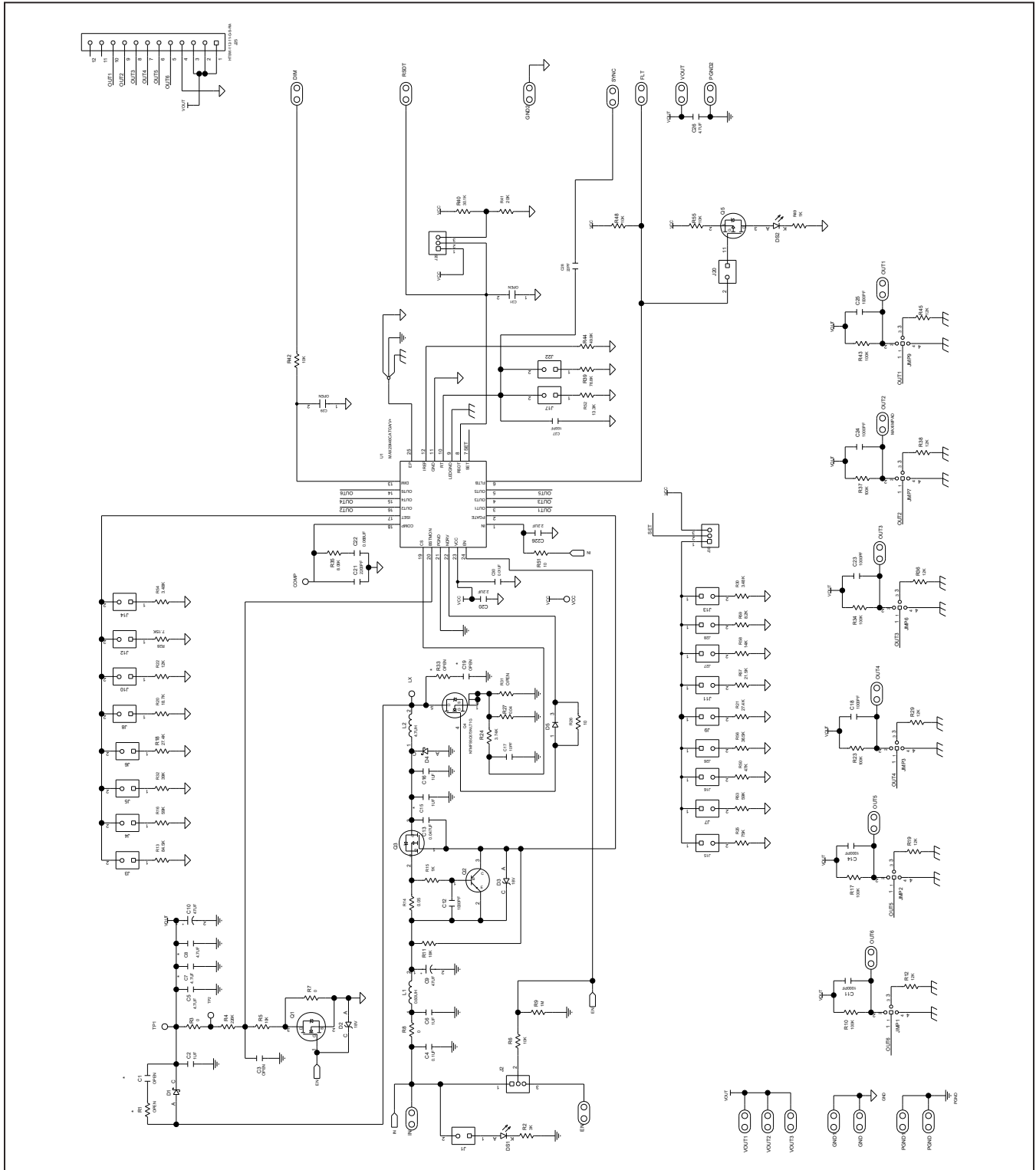

MAX20446C EV Kit PCB Layout Diagrams

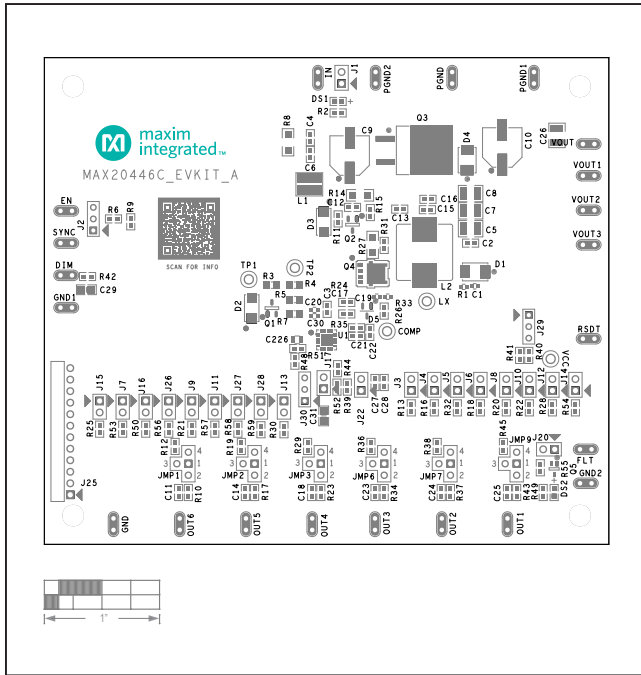

MAX20446C EV Kit Component Placement Guide—Top Silkscreen

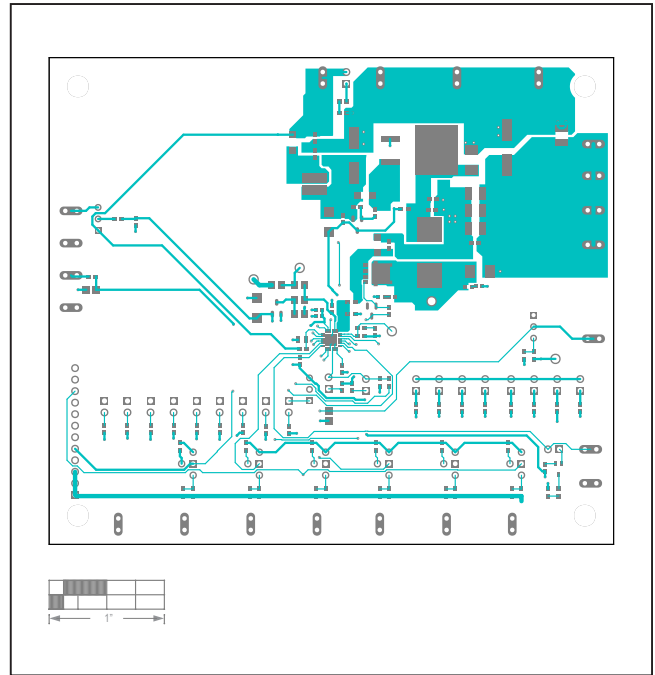

MAX20446C EV Kit PCB Layout—Internal Layer 2

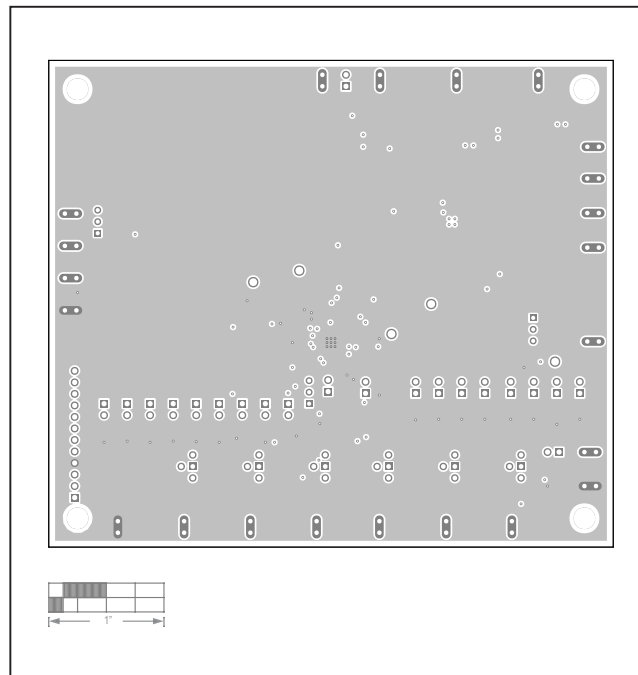

MAX20446C EV Kit PCB Layout—Top Layer

MAX20446C EV Kit PCB Layout Diagrams (continued)

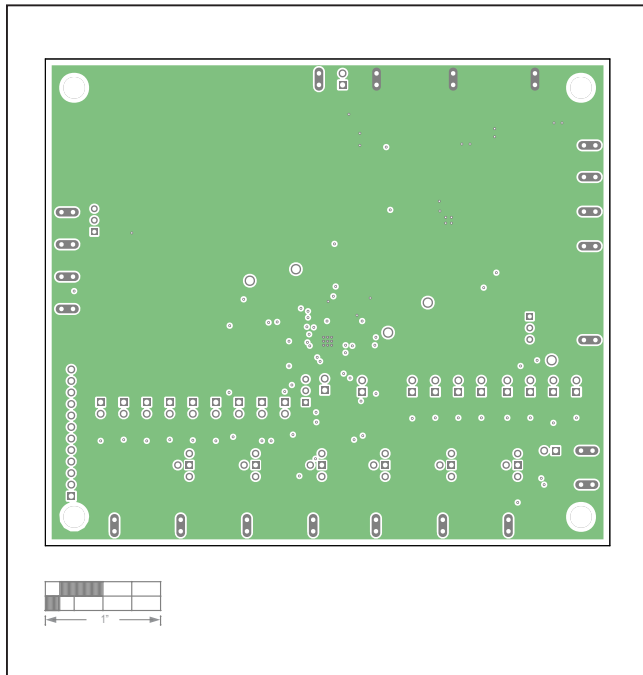

MAX20446C EV Kit PCB Layout—Internal Layer 3

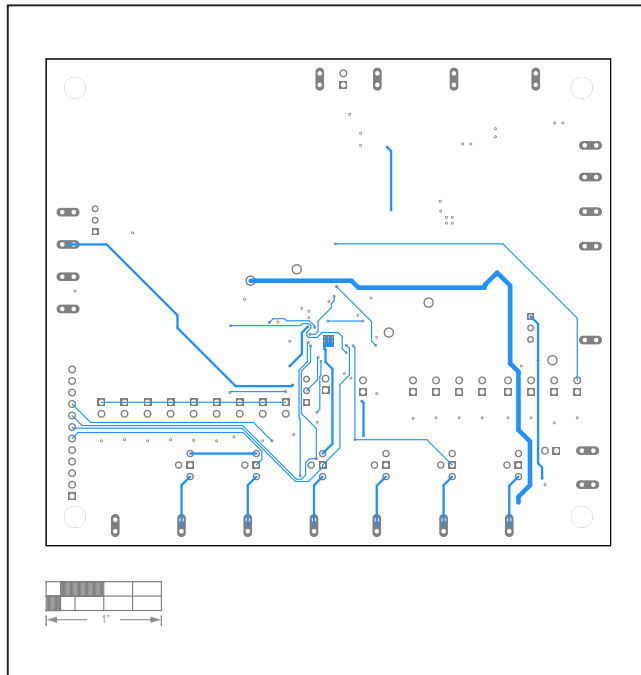

MAX20446C EV Kit PCB Layout—Bottom Layer

## Revision History

REVISION NUMBER	REVISION DATE	DESCRIPTION	PAGES CHANGED
0	2/21	Initial release	—

For pricing, delivery, and ordering information, please visit Maxim Integrated's online storefront at <https://www.maximintegrated.com/en/storefront/storefront.html>.

*Maxim Integrated cannot assume responsibility for use of any circuitry other than circuitry entirely embodied in a Maxim Integrated product. No circuit patent licenses are implied. Maxim Integrated reserves the right to change the circuitry and specifications without notice at any time.*