

Sanitary Pressure Transducers and Transmitters

Using Micro-Machined Silicon Technology

10 mV/V, 0 to 5 Vdc, 4 to 20 mA Outputs



Gage Pressure: 10 inH₂O to 600 psi (25 mb to 41 bar)
Absolute Pressure: 5 to 600 psi (345 mb to 41 bar)
Compound Gage: ±10 inH₂O to ±15 psi (±25 mb to ±1 bar)
Vacuum (Negative Gage): 0 to -10 inH₂O to 0 to -15 psi (25 mb to 1 bar)
Barometric Ranges: 0 to 32 inHg to 26 to 32 inHg

Twist-lock style.

mini DIN style.

1½" or 2" Tri-Grip™ Fitting

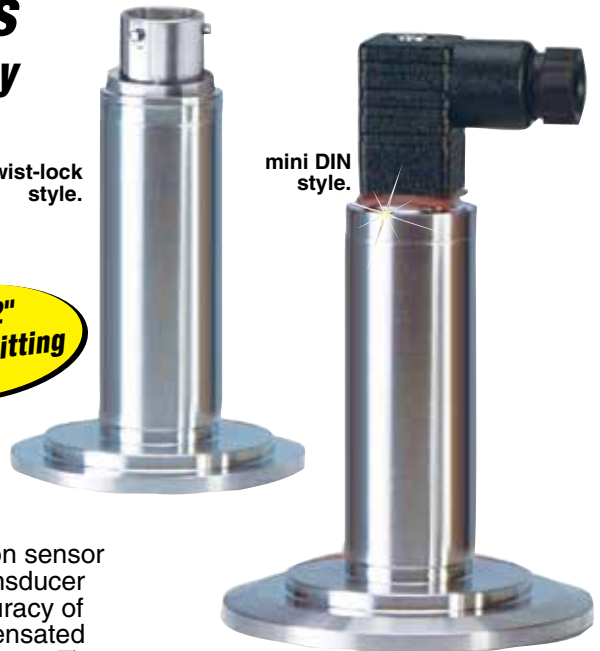

PX429S15-015GV, shown smaller than actual size.

PX419S20-100AV, shown smaller than actual size.

PX409S Tri-Grip™ Sanitary Series

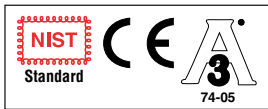

- High, 0.08% Accuracy
- Solid State Sensor for Durability
- Excellent Long Term Stability
- Welded Stainless Steel Construction
- 316L SS Wetted Parts
- Shock and Vibration Rated
- High Overpressure Rating
- Ruggedized with Secondary Containment System

The PX409S Series micro-machined silicon transducers with 1½" or 2" sanitary fittings are ideal for pressure or level CIP applications in food processing, beverage or bio/pharmaceutical applications as well as industrial applications that require a rugged, high accuracy transducer.

The micro-machined silicon sensor provides a very stable transducer with exceptional high accuracy of 0.08% and a broad compensated range of -4 to 85°C (25 to 185°F). The modular construction allows for fast delivery of most configurations and fittings.

Common Specifications

Accuracy: ±0.08% best straight line (linearity, hysteresis and repeatability combined) compound gage models calibrated in positive direction only

Calibration: 5-point NIST traceable calibration with zero and span values, calibrated in horizontal direction

Zero Balance: ±0.5% FS typical ±1% max (for ranges ≤2.5 psi ±1% typ. ±2% max)

Span Setting: ±0.5% FS typical ±1% max (for ranges ≤2.5 psi ±1% typ. ±2% max)

Operating Temperature Range: -15 to 115°C (-5 to 240°F)

Compensated Temperature Range:

Ranges ≤ 5 psi: 4.4 to 60°C (40 to 140°F)

Ranges > 5 psi: -4 to 85°C (25 to 185°F)

Temperature Compensation: Zero and Span Shift Over Compensated Range

Ranges ≤ 2.5 psi:

Zero: 1.00%

Span: 0.70%

Range = 5 psi:

Zero: 0.80%

Span: 0.50%

Ranges > 5psi:

Zero: 0.50%

Span: 0.50%

26B & 26HB Barometric Range:

Zero: 0.90%

Span: 0.50%

Minimum Isolation Between Case and Output Terminations:

100M Ω @ 50 Vdc

Pressure Cycles: 1 million cycles

Long Term Stability (1-Year): ±0.1% FS typical

Shock: 50 g, 11 ms half sine shock, (under test)

Vibration: ±20 g (under test)

Bandwidth: DC to 1 kHz typical

Response Time: <1 ms

Fill Fluid: NEOBEE M5 food grade

Approved to 3A Sanitary Specification 74-05

CE Compliant: Meets industrial emissions and immunity standard IEC61326 for industrial locations

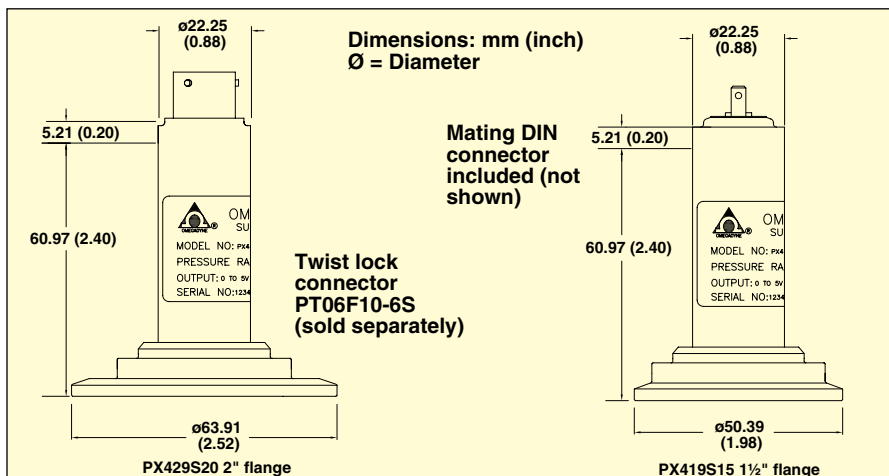

Environmental Protection:
IP65 or IP67 depending upon
electrical termination

Pressure Rating:
1½" and 2" Tri-Grip™ (compatible
with Tri-Clamp®)

Fitting: 600 psi using suitable clamp
Over Pressure: 4 x rated pressure
to maximum rated flange pressure

Secondary Containment: 6 x rated
pressure to a maximum of 2000 psi
(not in clamp)

Wetted Parts:
316L SS

Weight: 285 g (10 oz)

Sanitary Pressure Transducers Gage and Absolute Range

Electrical Terminations

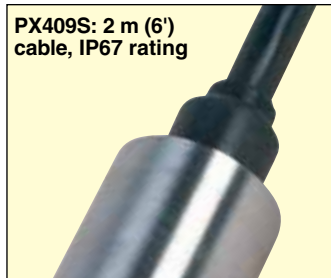

10 mV/V Output

- ✓ 1½" or 2" Tri-Grip™ Fittings Available
- ✓ All Stainless Steel Construction
- ✓ High Reliability Silicon Sensor
- ✓ 3A Approved

**10 mV/V
Output**

To Order			
Range		1½" Tri-Grip™ Fitting	2" Tri-Grip™ Fitting
psi	bar		
Gage Pressure Models, 10 mV/V Output			
0 to 10 inH ₂ O	0 to 25 mb	PX4[*]9S15-10WGV	PX4[*]9S20-10WGV
0 to 1	0 to 69 mb	PX4[*]9S15-001GV	PX4[*]9S20-001GV
0 to 2.5	0 to 172 mb	PX4[*]9S15-2.5GV	PX4[*]9S20-2.5GV
0 to 5	0 to 345 mb	PX4[*]9S15-005GV	PX4[*]9S20-005GV
0 to 15	0 to 1	PX4[*]9S15-015GV	PX4[*]9S20-015GV
0 to 30	0 to 2.1	PX4[*]9S15-030GV	PX4[*]9S20-030GV
0 to 50	0 to 3.4	PX4[*]9S15-050GV	PX4[*]9S20-050GV
0 to 100	0 to 6.9	PX4[*]9S15-100GV	PX4[*]9S20-100GV
0 to 150	0 to 10.3	PX4[*]9S15-150GV	PX4[*]9S20-150GV
0 to 250	0 to 17.2	PX4[*]9S15-250GV	PX4[*]9S20-250GV
0 to 500	0 to 34.5	PX4[*]9S15-500GV	PX4[*]9S20-500GV
0 to 600	0 to 41.4	PX4[*]9S15-600GV	
Absolute Pressure Models, 10 mV/V Output			
0 to 5	0 to 345 mb	PX4[*]9S15-005AV	PX4[*]9S20-005AV
0 to 15	0 to 1	PX4[*]9S15-015AV	PX4[*]9S0-015AV
0 to 30	0 to 2.1	PX4[*]9S15-030AV	PX4[*]9S20-030AV
0 to 50	0 to 3.4	PX4[*]9S15-050AV	PX4[*]9S20-050AV
0 to 100	0 to 6.9	PX4[*]9S15-100AV	PX4[*]9S20-100AV
0 to 150	0 to 10.3	PX4[*]9S15-150AV	PX4[*]9S20-150AV
0 to 250	0 to 17.2	PX4[*]9S15-250AV	PX4[*]9S20-250AV
0 to 500	0 to 34.5	PX4[*]9S15-500AV	PX4[*]9S20-500AV
0 to 600	0 to 41.4	PX4[*]9S15-600AV	

[*] Select Electrical Termination Below (no extra charge)

0 (PX409S) = 2 m (6') cable**

1 (PX419S) = mini DIN connector (mating connector supplied)

2 (PX429S) = twist lock connector (mating connector PT06F10-6S sold separately)

5 (PX459S) = M12 connector (M12 cables sold separately, see accessories on next page)

** To order with a ½ NPT conduit fitting, specify model **PX409CS**.

Ordering Examples: **PX409S15-005GV**, 2 m (6') cable termination, 1.5" Tri-Grip fitting, 5 psig range, 10 mV/V output.

PX419S20-10WGV, mini DIN connector, 2" Tri-Grip fitting, 10 inH₂O range, 10 mV/V output.

PX429S15-050GV, twist-lock connector, 1.5" Tri-Grip fitting, 50 psig range, 10 mV/V output. mating connector sold separately, **PT06F10-6S**.

PX459S15-100GV, M12 connector, 1.5" Tri-Grip fitting, 100 psig range, 10 mV/V output.

Sanitary Pressure Transducers

Compound, Vacuum and Barometric Ranges

Specifications (mV/V Output)

Output: 10 mV/V: ratiometric
5 to 10 Vdc

Supply: 5 to 10 Vdc

Accuracy: ±0.08% BSL (linearity, hysteresis repeatability combined)
compound gage models calibrated in positive direction only

Electrical Terminations

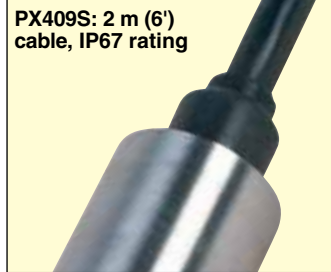

To Order

Range		1½ Tri-Grip™ Fitting	2" Tri-Grip™ Fitting
psi	mbar		
Compound Gage Ranges			
±10 inH ₂ O	±25	PX4[*]9S15-10WCGV	PX4[*]9S20-10WCGV
±1	±69	PX4[*]9S15-001CGV	PX4[*]9S20-001CGV
±2.5	±172	PX4[*]9S15-2.5CGV	PX4[*]9S20-2.5CGV
±5	±345	PX4[*]9S15-005CGV	PX4[*]9S20-005CGV
±15	±1034	PX4[*]9S15-015CGV	PX4[*]9S20-015CGV
Vacuum Ranges (Negative Gage, 0 = Ambient)			
0 to -10 inH ₂ O	0 to -25	PX4[*]9S15-10WVV	PX4[*]9S20-10WVV
0 to -1	0 to -69	PX4[*]9S15-001VV	PX4[*]9S20-001VV
0 to -2.5	0 to -172	PX4[*]9S15-2.5VV	PX4[*]9S20-2.5VV
0 to -5	0 to -345	PX4[*]9S15-005VV	PX4[*]9S20-005VV
0 to -15	0 to -1034	PX4[*]9S15-015VV	PX4[*]9S20-015VV
Barometric Ranges (Absolute Pressure)			
0 to 32 inHg	—	PX4[*]9S15-32BV	PX4[*]9S20-32BV
16 to 32 inHg	—	PX4[*]9S15-16BV	PX4[*]9S20-16BV
26 to 32 inHg	—	PX4[*]9S15-26BV	PX4[*]9S20-26BV
—	0 to 1100 hPa	PX4[*]9S15-32HBV	PX4[*]9S20-32HBV
—	550 to 1100 hPa	PX4[*]9S15-16HBV	PX4[*]9S20-16HBV
—	880 to 1100 hPa	PX4[*]9S15-26HBV	PX4[*]9S20-26HBV

Accessories

Model No.	Description
M12C-PVC-4-S-F-5	PVC cable, straight 4-pin M12 female connector one end, flying leads one end, 5 m (16.4') long, for PX459
M12C-PVC-4-R-F-5	PVC cable, right angled 4-pin M12 female connector one end, flying leads one end 5 m (16.4') long, for PX459
PT06F10-65	Twist lock connector for PX429

[*] Select Electrical Termination Below (no extra charge)

0 (PX409S) = 2 m (6') with flying leads**

1 (PX419S) = mini DIN connector (mating connector supplied)

2 (PX429S) = twist lock connector (mating connector PT06F-10S sold separately)

5 (PX459S) = M12 connector (M12 cables sold separately see chart above)

** To order with a ½ NPT conduit fitting, specify model PX409CS.

Custom configurations also available, see omega.com/pxconfig

Ordering Examples: PX409S15-015CGV, cable termination, 1.5" Tri-grip fitting, ±15 psig range, 10 mV/V output.

PX459S20-001VV, M12 termination, 2" Tri-grip fitting, 0 to -1 psi (vacuum) range, 10 mV/V output.

PX419S15-16HBV, mini DIN termination, 1.5" Tri-grip fitting, 550 to 1100 hPa calibrated range, 10 mV/V output.

Sanitary Pressure Transducers Gages and Absolute Ranges

**0 to 5 Vdc or
0 to 10 Vdc
Output**

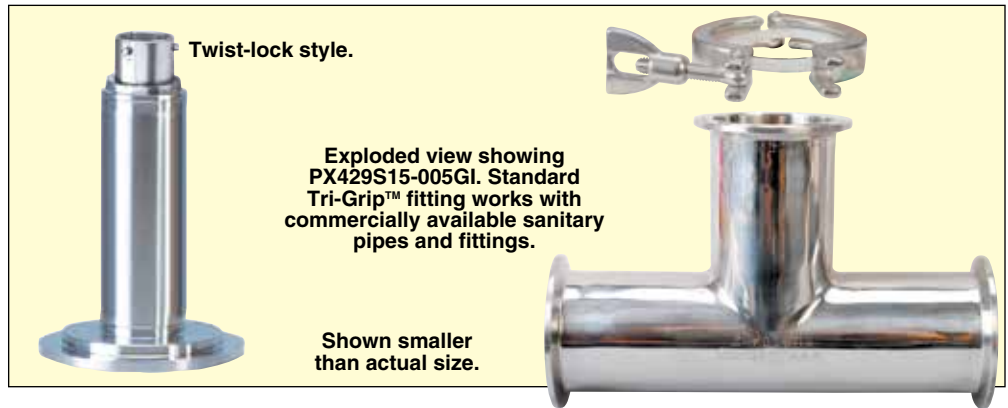

Twist-lock style.

Exploded view showing PX429S15-005G1. Standard Tri-Grip™ fitting works with commercially available sanitary pipes and fittings.

Shown smaller than actual size.

0 to 5 or 0 to 10 Vdc Output

- ✓ 1½" or 2" Tri-Grip™ Fittings Available
- ✓ All Stainless Steel Construction
- ✓ High Reliability Silicon Sensor
- ✓ 3A Approved



DP41-E, shown smaller than actual size.

To Order			
Range		1½" Tri-Grip™ Fitting	2" Tri-Grip™ Fitting
psi	bar		
Gage Pressure Models, 0 to 5 Vdc Output			
0 to 10 inH ₂ O	0 to 25 mb	PX4[*]9S15-10WG5V	PX4[*]9S20-10WG5V
0 to 1	0 to 69 mb	PX4[*]9S15-001G5V	PX4[*]9S20-001G5V
0 to 2.5	0 to 172 mb	PX4[*]9S15-2.5G5V	PX4[*]9S20-2.5G5V
0 to 5	0 to 345 mb	PX4[*]9S15-005G5V	PX4[*]9S20-005G5V
0 to 15	0 to 1	PX4[*]9S15-015G5V	PX4[*]9S0-015G5V
0 to 30	0 to 2.1	PX4[*]9S15-030G5V	PX4[*]9S20-030G5V
0 to 50	0 to 3.4	PX4[*]9S15-050G5V	PX4[*]9S20-050G5V
0 to 100	0 to 6.9	PX4[*]9S15-100G5V	PX4[*]9S20-100G5V
0 to 150	0 to 10.3	PX4[*]9S15-150G5V	PX4[*]9S20-150G5V
0 to 250	0 to 17.2	PX4[*]9S15-250G5V	PX4[*]9S20-250G5V
0 to 500	0 to 34.5	PX4[*]9S15-500G5V	PX4[*]9S20-500G5V
0 to 600	0 to 41.4	PX4[*]9S15-600G5V	
Absolute Pressure Models, 0 to 5 Vdc Output			
0 to 5	0 to 345 mb	PX4[*]9S15-005A5V	PX4[*]9S20-005A5V
0 to 15	0 to 1	PX4[*]9S15-015A5V	PX4[*]9S0-015A5V
0 to 30	0 to 2.1	PX4[*]9S15-030A5V	PX4[*]9S20-030A5V
0 to 50	0 to 3.4	PX4[*]9S15-050A5V	PX4[*]9S20-050A5V
0 to 100	0 to 6.9	PX4[*]9S15-100A5V	PX4[*]9S20-100A5V
0 to 150	0 to 10.3	PX4[*]9S15-150A5V	PX4[*]9S20-150A5V
0 to 250	0 to 17.2	PX4[*]9S15-250A5V	PX4[*]9S20-250A5V
0 to 500	0 to 34.5	PX4[*]9S15-500A5V	PX4[*]9S20-500A5V
0 to 600	0 to 41.4	PX4[*]9S15-600A5V	

[*] Select Electrical Termination Below (no extra charge)

0 (PX409S) = 2 m (6') cable**

1 (PX419S) = mini DIN connector (mating connector supplied)

2 (PX429S) = twist Lock connector (mating connector PT06F10-6S not included)

5 (PX459S) = M12 connector (M12 cables sold separately, see accessories on next page)

** To order with a ½ NPT conduit fitting, specify model **PX409CS**.

To order 0 to 10 Vdc output, change "5V" to "10V", no extra charge.

Ordering Examples: PX409S15-005G5V, 2 m (6') cable termination, 1.5" Tri-Grip fitting, 5 psig range, 0 to 5 Vdc output.

PX419S20-10WG5V, mini DIN connector, 2" Tri-Grip fitting, 10 inH₂O range, 0 to 5 Vdc output.

PX429S15-050G10V, twist-lock connector, 1.5" Tri-Grip fitting, 50 psig range, 0 to 10 Vdc output, mating connector sold separately, PT06F10-6S.

PX459S15-100G5V, M12 connector, 1.5" Tri-Grip fitting, 100 psig range, 0 to 5 Vdc output.

Sanitary Pressure Transmitters

Compound, Vacuum and Barometric Ranges

Electrical Terminations

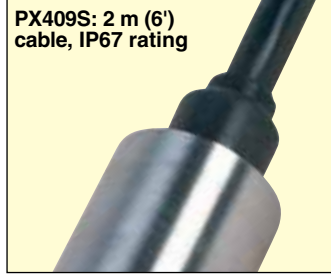

Specifications (Amplified Voltage Output)

Output/Supply:
 0 to 5 Vdc: 10 to 30 Vdc
 0 to 10 Vdc: 15 to 30 Vdc

Accuracy: $\pm 0.08\%$ BSL (linearity, hysteresis repeatability combined)
 compound gage models calibrated in positive direction only

To Order

Range		1½ Tri-Grip™ Fitting	2 Tri-Grip™ Fitting
psi	mbar		
Compound Gage Ranges			
±10 inH ₂ O	±25	PX4[*]9S15-10WCG5V	PX4[*]9S20-10WCG5V
±1	±69	PX4[*]9S15-001CG5V	PX4[*]9S20-001CG5V
±2.5	±172	PX4[*]9S15-2.5CG5V	PX4[*]9S20-2.5CG5V
±5	±345	PX4[*]9S15-005CG5V	PX4[*]9S20-005CG5V
±15	±1034	PX4[*]9S15-015CG5V	PX4[*]9S20-015CG5V
Vacuum Ranges (Negative Gage, 0 = Ambient)			
0 to -10 inH ₂ O	0 to -25	PX4[*]9S15-10WV5V	PX4[*]9S20-10WV5V
0 to -1	0 to -69	PX4[*]9S15-001V5V	PX4[*]9S20-001V5V
0 to -2.5	0 to -172	PX4[*]9S15-2.5V5V	PX4[*]9S20-2.5V5V
0 to -5	0 to -345	PX4[*]9S15-005V5V	PX4[*]9S20-005V5V
0 to -15	0 to -1034	PX4[*]9S15-015V5V	PX4[*]9S20-015V5V
Barometric Ranges (Absolute Pressure)			
0 to 32 inHg	—	PX4[*]9S15-32B5V	PX4[*]9S20-32B5V
16 to 32 inHg	—	PX4[*]9S15-16B5V	PX4[*]9S20-16B5V
26 to 32 inHg	—	PX4[*]9S15-26B5V	PX4[*]9S20-26B5V
—	0 to 1100 hPa	PX4[*]9S15-32HB5V	PX4[*]9S20-32HB5V
—	550 to 1100 hPa	PX4[*]9S15-16HB5V	PX4[*]9S20-16HB5V
—	880 to 1100 hPa	PX4[*]9S15-26HB5V	PX4[*]9S20-26HB5V

Accessories

Model No.	Description
M12C-PVC-4-S-F-5	PVC cable, straight 4-pin M12 female connector one end, flying leads one end, 5 m (16.4') long, for PX459
M12C-PVC-4-R-F-5	PVC cable, right angled 4-pin M12 female connector one end, flying leads one end 5 m (16.4') long, for PX459
PT06F10-65	Twist lock connector for PX429

[*] Select Electrical Termination Below (no extra charge)

- 0 (PX409S) = 2 m (6') with flying leads**
- 1 (PX419S) = mini DIN connector (mating connector supplied)
- 2 (PX429S) = twist lock connector (mating connector PT06F-10S sold separately)
- 5 (PX459S) = M12 connector (M12 cables sold separately see chart above)

** To order with a ½ NPT conduit fitting, specify model **PX409CS**.

To order 0 to 10 Vdc output, change "5V" to "10V", no extra charge.

Ordering Examples: **PX409S15-015CG5V**, cable termination, 1.5" Tri-grip fitting, ±15 psig range, 0 to 5 Vdc output.

PX459S20-001V5V, M12 termination, 2" Tri-grip fitting, 0 to -1 psi (vacuum) range, 0 to 5 Vdc output.

PX419S15-16HB10V, mini DIN termination, 1.5" Tri-grip fitting, 550 to 1100 hPa calibrated range, 0 to 10 Vdc output.

Sanitary Pressure Transducers Gages and Absolute Ranges

Electrical Terminations



4 to 20 mA

- ✓ 1½" or 2" Tri-Grip™ Fittings Available
- ✓ All Stainless Steel Construction
- ✓ High Reliability Silicon Sensor
- ✓ 3A Approved

**4 to 20 mA
Output**

To Order			
Range		1½" Tri-Grip™ Fitting	2" Tri-Grip™ Fitting
psi	bar		
Gage Pressure Models, 4 to 20 mA Output			
0 to 10 inH ₂ O	0 to 25 mb	PX4[*]9S15-10WGI	PX4[*]9S20-10WGI
0 to 1	0 to 69 mb	PX4[*]9S15-001GI	PX4[*]9S20-001GI
0 to 2.5	0 to 172 mb	PX4[*]9S15-2.5GI	PX4[*]9S20-2.5GI
0 to 5	0 to 345 mb	PX4[*]9S15-005GI	PX4[*]9S20-005GI
0 to 15	0 to 1	PX4[*]9S15-015GI	PX4[*]9S20-015GI
0 to 30	0 to 2.1	PX4[*]9S15-030GI	PX4[*]9S20-030GI
0 to 50	0 to 3.4	PX4[*]9S15-050GI	PX4[*]9S20-050GI
0 to 100	0 to 6.9	PX4[*]9S15-100GI	PX4[*]9S20-100GI
0 to 150	0 to 10.3	PX4[*]9S15-150GI	PX4[*]9S20-150GI
0 to 250	0 to 17.2	PX4[*]9S15-250GI	PX4[*]9S20-250GI
0 to 500	0 to 34.5	PX4[*]9S15-500GI	PX4[*]9S20-500GI
0 to 600	0 to 41.4	PX4[*]9S15-600GI	
Absolute Pressure Models, 4 to 20 mA Output			
0 to 5	0 to 345 mb	PX4[*]9S15-005AI	PX4[*]9S20-005AI
0 to 15	0 to 1	PX4[*]9S15-015AI	PX4[*]9S20-015AI
0 to 30	0 to 2.1	PX4[*]9S15-030AI	PX4[*]9S20-030AI
0 to 50	0 to 3.4	PX4[*]9S15-050AI	PX4[*]9S20-050A
0 to 100	0 to 6.9	PX4[*]9S15-100AI	PX4[*]9S20-100AI
0 to 150	0 to 10.3	PX4[*]9S15-150AI	PX4[*]9S20-150AI
0 to 250	0 to 17.2	PX4[*]9S15-250AI	PX4[*]9S20-250AI
0 to 500	0 to 34.5	PX4[*]9S15-500AI	PX4[*]9S20-500AI
0 to 600	0 to 41.4	PX4[*]9S15-600AI	

[*] Select Electrical Termination Below (no extra charge)

0 (PX409S) = 2 m (6') cable**

1 (PX419S) = mini DIN connector (mating connector supplied)

2 (PX429S) = Twist Lock connector (mating connector PT06F10-6S sold separately)

5 (PX459S) = M12 connector (M12 cables sold separately, see accessories on next page)

** To order with a ½ NPT conduit fitting, specify model **PX409CS**.

Ordering Examples: PX409S15-005GI, 2 m (6') cable termination, 1.5" Tri-Grip fitting, 5 psig range, 4 to 20 mA output.

PX419S20-10WGI, mini DIN connector, 2" Tri-Grip fitting, 10 inH₂O range, 4 to 20 mA output.

PX429S15-050GI, twist-lock connector, 1.5" Tri-Grip fitting, 50 psig range, 4 to 20 mA output, mating connector sold separately, **PT06F10-6S**.

PX459S15-100GI, M12 connector, 1.5" Tri-Grip fitting, 100 psig range, 4 to 20 mA output.

Sanitary Pressure Transmitters

Compound, Vacuum and Barometric Ranges

Specifications)

Output/Supply:

Output: 4 to 20 mAdc

Supply: 9 to 30 Vdc

[9 to 20 Vdc above 105°C (229°F)]

max loop res $\Omega = (Vs-9) \times 50$

Accuracy: $\pm 0.08\%$ BSL (linearity, hysteresis repeatability combined) compound gage models calibrated in positive direction only

4 to 20 mA Output

Electrical Terminations

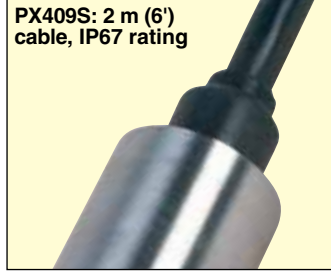

To Order			
Range		1½ Tri-Grip™ Fitting	2" Tri-Grip™ Fitting
psi	mbar		
Compound Gage Ranges			
±10 inH ₂ O	±25	PX4[*]9S15-10WCGI	PX4[*]9S20-10WCGI
±1	±69	PX4[*]9S15-001CGI	PX4[*]9S20-001CGI
±2.5	±172	PX4[*]9S15-2.5CGI	PX4[*]9S20-2.5CGI
±5	±345	PX4[*]9S15-005CGI	PX4[*]9S20-005CGI
±15	±1034	PX4[*]9S15-015CGI	PX4[*]9S20-015CGI
Vacuum Ranges (Negative Gage, 0 = Ambient)			
0 to -10 inH ₂ O	0 to -25	PX4[*]9S15-10WVI	PX4[*]9S20-10WVI
0 to -1	0 to -69	PX4[*]9S15-001VI	PX4[*]9S20-001VI
0 to -2.5	0 to -172	PX4[*]9S15-2.5VI	PX4[*]9S20-2.5VI
0 to -5	0 to -345	PX4[*]9S15-005VI	PX4[*]9S20-005VI
0 to -15	0 to -1034	PX4[*]9S15-015VI	PX4[*]9S20-015VI
Barometric Ranges (Absolute Pressure)			
0 to 32 inHg	—	PX4[*]9S15-32BI	PX4[*]9S20-32BI
16 to 32 inHg	—	PX4[*]9S15-16BI	PX4[*]9S20-16BI
26 to 32 inHg	—	PX4[*]9S15-26BI	PX4[*]9S20-26BI
—	0 to 1100 hPa	PX4[*]9S15-32HBI	PX4[*]9S20-32HBI
—	550 to 1100 hPa	PX4[*]9S15-16HBI	PX4[*]9S20-16HBI
—	880 to 1100 hPa	PX4[*]9S15-26HBI	PX4[*]9S20-26HBI

Accessories

Model No.	Description
M12C-PVC-4-S-F-5	PVC cable, straight 4-pin M12 female connector one end, flying leads one end, 5 m (16.4') long, for PX459
M12C-PVC-4-R-F-5	PVC cable, right angled 4-pin M12 female connector one end, flying leads one end 5 m (16.4') long, for PX459
PT06F10-65	Twist lock connector for PX429

[*] Select Electrical Termination Below (no extra charge)

0 (PX409S) = 2 m (6') cable with flying leads**

1 (PX419S) = mini DIN cable (mating connector included)

2 (PX429S) = twist-lock connector (mating connector PT06F-10S sold separately)

5 (PX459S) = M12 connector, (M12 cables sold separately see chart above)

** For ½ NPT conduit connector order model PX409CS

Custom configurations also available, see omega.com/pxconfig

Ordering Examples: PX409S15-015CGI, cable termination, 1.5" Tri-grip fitting, ±15 psig range, 4 to 20 mA output.

PX459S20-001VI, M12 termination, 2" Tri-grip fitting, 0 to -1 psi (vacuum) range, 4 to 20 mA output.

PX419S15-16HBI, mini DIN termination, 1.5" Tri-grip fitting, 550 to 1100 hPa calibrated range, 4 to 20 mA output.

High Accuracy Pressure Transducers

Piezoresistive Design With High Temperature Performance

All images shown smaller than actual size.

Cable style.



PX409S Series

PX409 Cable Connection			
Color	mV	5/10V	mA
Black	- EXC	Common	- Supply
White	+ SIG	+ Output	NC
Green	- SIG	NC	NC
Red	+ EXC	+ EXC	+ Supply

mini DIN and M12 style.



PX419S Series

PX459S M12 connector.

PX419/PX459 Pinout			
Pin	mV	5/10V	mA
1	+ EXC	+ EXC	+ Supply
2	- EXC	Common	- Supply
3	+ SIG	+ Output	NC
4	- SIG	NC	NC

Twist-lock style.



PX429S Series

PX429 Twist-Lock Pinout			
Pin	mV	5/10V	mA
A	+ EXC	+ EXC	+ Supply
B	- EXC	Common	- Supply
C	+ SIG	+ Output	NC
D	- SIG	NC	NC
E	NC	NC	NC
F	NC	NC	NC

NC = No Connection.

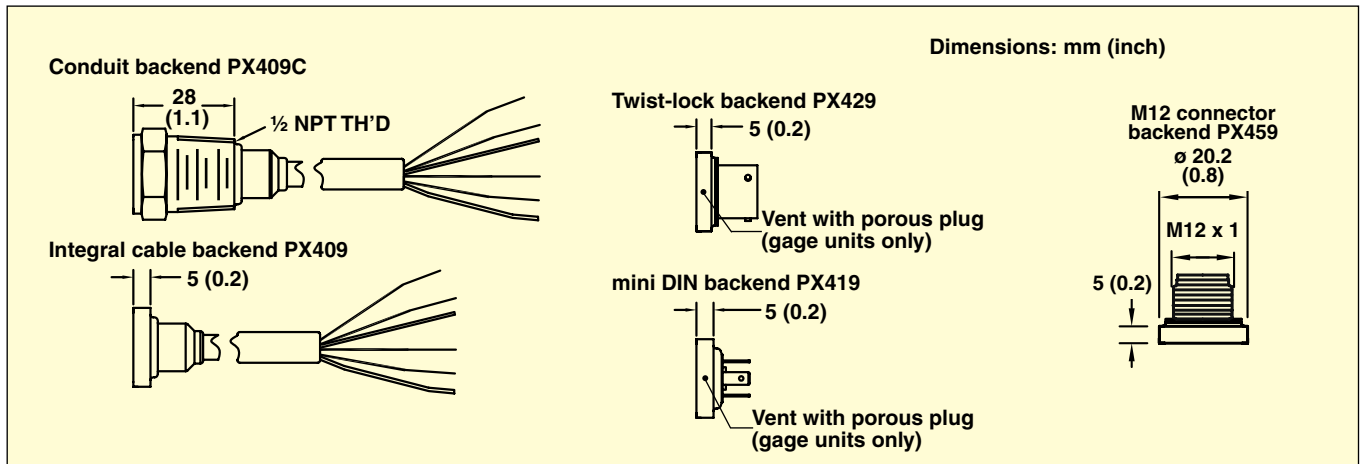

Compatible Meters and Accessories

Meters	
Model No.	Description
DP41-S	6-digit high accuracy (0.005%) process meter for use with milli voltage and strain gage bridge output models
DP41-E	6-digit high accuracy (0.005%) meter for use with voltage and current output models
DP25B-E	4-digit precision process meter for use with voltage and current output models
Accessories	
CX5302	Extra mini DIN connector for PX419 Series
PT06F10-6S	Mating twist lock connector for PX429 Series
M12C-PVC-4-S-F-5	PVC cable, straight 4-pin M12 female connector one end, flying leads one end, 5 m (16.4') long, for PX459
M12C-PVC-4-R-F-5	PVC cable, right angled 4-pin M12 female connector one end, flying leads one end 5 m (16.4') long, for PX459

Sanitary Pressure Transducers and Transmitters



Using Micro-Machined Silicon Technology
10 mV/V, 0 to 5 Vdc, 4 to 20 mA Outputs

Gage or Absolute Pressures
10 inH₂O to 600 psi
(25 mbar to 41 bar)
Gage 5 psi to 500 psi
(344 mb to 34.5 bar) Absolute
1½" or 2" Tri-Grip Fitting

PX409S Tri-Grip™ Sanitary Series



- ✓ High, 0.08%, Accuracy
- ✓ Solid State Sensor for Durability
- ✓ Excellent Long Term Stability
- ✓ Welded Stainless Steel Construction
- ✓ 316L SS Wetted Parts
- ✓ Shock and Vibration Rated
- ✓ High Overpressure Rating
- ✓ Ruggedized with Secondary Containment

The PX409S Series micro-machined silicon transducers with 1½" or 2" sanitary fittings are ideal for pressure or level CIP applications in food processing, beverage or bio/pharmaceutical applications as well as industrial applications that require a rugged, high accuracy transducer. The micro-machined silicon sensor provides a very stable transducer with exceptional high accuracy of 0.08% and a broad compensated range of -6.7 to 85°C (20 to 185°F). The modular construction allows for fast delivery of most configurations and fittings.

Specifications

Accuracy: 0.08% Best Straight Line (Linearity, Hysteresis and Repeatability combined)

Operating Temperature Range: -15 to 115°C (-5 to 240°F)

Compensated Temperature Range: -6.7 to 85°C (20 to 185°F)

Temperature Compensation: Zero and span combined

≥ 5 psi: 1% over 55.6°C (100°F) range



Twist-lock style.

PX429S15-015GV, shown smaller than actual size.

1½" or 2" Tri-Grip™ Fitting



mini DIN style.

PX419S20-100AV, shown smaller than actual size.

≤ 2.5 psi: 2% over 55.6°C (100°F) range

Min Isolation Between Case and Output Terminations: 100 MΩ @ 50 Vdc

Pressure Cycles: 1 million, minimum

Long Term Stability (1-Year): ±0.1% FS typ.

Shock: 50 g, 11 ms half sine shock, (under test)

Vibration: ±20 g (under test)

Bandwidth: DC to 1 kHz typical

Response Time: <1 ms

Fill Fluid: NEOBEE M5 Food grade

Designed to Meet or Exceed 3A Sanitary Specification 74-05

CE Compliant: Meets industrial emissions and immunity standard IEC61326

Environmental Protection: IP65 or IP67 depending upon electrical termination

Pressure Rating: 1½" and 2" Tri-Grip™ (Tri-Clamp® compatible) fitting: 600 psi using suitable clamp

Over Pressure: 4 x rated pressure to maximum rated flange pressure

Secondary Containment: 6 x rated pressure to a maximum of 2000 psi (not in clamp)

Wetted Parts: 316L SS

Weight: 285 gm (10 oz)

Dimensions: mm (inch)
Ø = Diameter

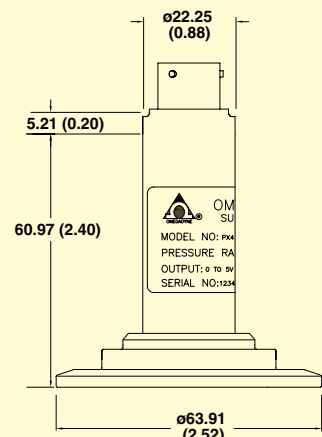

PX429S20 2" flange

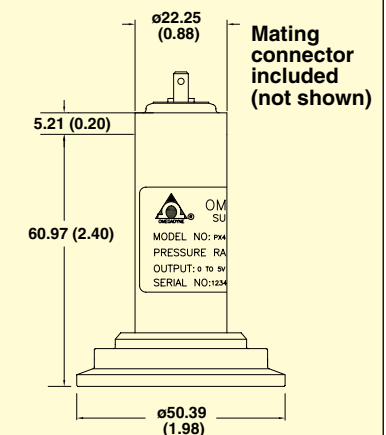

PX419S15 1½" flange

Mating connector included (not shown)

**10 mV/V
Output**

Electrical Terminations

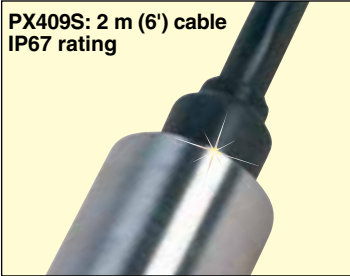

**Specifications (10 mV/V
Output)**

Output/ Supply: 10 mV/V;
Ratiometric 5 to 10 Vdc
Accuracy: ±0.08% BSL
(linearity, hysteresis repeatability
combined)

Zero Balance: ±0.5% FS typical
1% max (For ranges ≤2.5 psi
±1% typ ±2% max)

Span Setting: ±0.5% FS typical 1%
max (For ranges ≤2.5 psi ±1% typ
±2% max) Calibrated in horizontal
position

To Order			
Range		1½" Tri-Grip™ Fitting	2" Tri-Grip™ Fitting
psi	bar		
Gage Pressure Models, 10 mV/V Output			
0 to 10 inH ₂ O	0 to 25 mb	PX4[*]9S15-10WGV	PX4[*]9S20-10WGV
0 to 1	0 to 69 mb	PX4[*]9S15-001GV	PX4[*]9S20-001GV
0 to 2.5	0 to 172 mb	PX4[*]9S15-2.5GV	PX4[*]9S20-2.5GV
0 to 5	0 to 345 mb	PX4[*]9S15-005GV	PX4[*]9S20-005GV
0 to 15	0 to 1	PX4[*]9S15-015GV	PX4[*]9S20-015GV
0 to 30	0 to 2.1	PX4[*]9S15-030GV	PX4[*]9S20-030GV
0 to 50	0 to 3.4	PX4[*]9S15-050GV	PX4[*]9S20-050GV
0 to 100	0 to 6.9	PX4[*]9S15-100GV	PX4[*]9S20-100GV
0 to 150	0 to 10.3	PX4[*]9S15-150GV	PX4[*]9S20-150GV
0 to 250	0 to 17.2	PX4[*]9S15-250GV	PX4[*]9S20-250GV
0 to 500	0 to 34.5	PX4[*]9S15-500GV	PX4[*]9S20-500GV
0 to 600	0 to 41.4	PX4[*]9S15-600GV	
Absolute Pressure Models, 10 mV/V Output			
0 to 5	0 to 345 mb	PX4[*]9S15-005AV	PX4[*]9S20-005AV
0 to 15	0 to 1	PX4[*]9S15-015AV	PX4[*]9S20-015AV
0 to 30	0 to 2.1	PX4[*]9S15-030AV	PX4[*]9S20-030AV
0 to 50	0 to 3.4	PX4[*]9S15-050AV	PX4[*]9S20-050A
0 to 100	0 to 6.9	PX4[*]9S15-100AV	PX4[*]9S20-100AV
0 to 150	0 to 10.3	PX4[*]9S15-150AV	PX4[*]9S20-150AV
0 to 250	0 to 17.2	PX4[*]9S15-250AV	PX4[*]9S20-250AV
0 to 500	0 to 34.5	PX4[*]9S15-500AV	PX4[*]9S20-500AV
0 to 600	0 to 41.4	PX4[*]9S15-600AV	

[*] Select Electrical Termination Below

- 0 (PX409S) = 2 m (6') cable**
- 1 (PX419S) = mini DIN connector (mating connector supplied)
- 2 (PX429S) = Twist Lock connector (mating connector PT06F10-6S not included)
- 5 (PX459S) = M12 connector (mating connector not included)

** To order with a ½ NPT conduit fitting, specify model **PX409CS**.

Ordering Examples: PX409S15-005GV, 2 m (6') cable termination, 1.5" Tri-Grip fitting, 5 psig range, 10 mV/V output.

PX419S20-10WGV, mini DIN connector, 2" Tri-Grip fitting, 10 inH₂O range, 10 mV/V output.

PX429S15-050GV, twist-lock connector, 1.5" Tri-Grip fitting, 50 psig range, 10 mV/V output, mating connector sold separately, **PT06F10-6S**.

PX459S15-100GV, M12 connector, 1.5" Tri-Grip fitting, 100 psig range, 10 mV/V output.

0 to 5/
0 to 10 Vdc
Output

**Specifications
(Amplified Voltage
Output)**

Output/ Supply:
0 to 5 Vdc: 10 to 30 Vdc @ 10 mA
0 to 10 Vdc: 15 to 30 Vdc @ 10 mA
Accuracy: ±0.08% BSL (linearity, hysteresis repeatability combined)

Zero Balance: ±0.5% FS typical
±1% max (For ranges ≤2.5 psi
±1% typ ±2% max)
Span Setting: ±0.5% FS typical
1% max (For ranges ≤2.5 psi
±1% typ ±2% max) calibrated in
horizontal position



To Order			
Range		1½" Tri-Grip™ Fitting	2" Tri-Grip™ Fitting
psi	bar		
Gage Pressure Models, 0 to 5 Vdc Output			
0 to 10 inH ₂ O	0 to 25 mb	PX4[*]9S15-10WG5V	PX4[*]9S20-10WG5V
0 to 1	0 to 69 mb	PX4[*]9S15-001G5V	PX4[*]9S20-001G5V
0 to 2.5	0 to 172 mb	PX4[*]9S15-2.5G5V	PX4[*]9S20-2.5G5V
0 to 5	0 to 345 mb	PX4[*]9S15-005G5V	PX4[*]9S20-005G5V
0 to 15	0 to 1	PX4[*]9S15-015G5V	PX4[*]9S0-015G5V
0 to 30	0 to 2.1	PX4[*]9S15-030G5V	PX4[*]9S20-030G5V
0 to 50	0 to 3.4	PX4[*]9S15-050G5V	PX4[*]9S20-050G5V
0 to 100	0 to 6.9	PX4[*]9S15-100G5V	PX4[*]9S20-100G5V
0 to 150	0 to 10.3	PX4[*]9S15-150G5V	PX4[*]9S20-150G5V
0 to 250	0 to 17.2	PX4[*]9S15-250G5V	PX4[*]9S20-250G5V
0 to 500	0 to 34.5	PX4[*]9S15-500G5V	PX4[*]9S20-500G5V
0 to 600	0 to 41.4	PX4[*]9S15-600G5V	
Absolute Pressure Models, 0 to 5 Vdc Output			
0 to 5	0 to 345 mb	PX4[*]9S15-005A5V	PX4[*]9S20-005A5V
0 to 15	0 to 1	PX4[*]9S15-015A5V	PX4[*]9S0-015A5V
0 to 30	0 to 2.1	PX4[*]9S15-030A5V	PX4[*]9S20-030A5V
0 to 50	0 to 3.4	PX4[*]9S15-050A5V	PX4[*]9S20-050A
0 to 100	0 to 6.9	PX4[*]9S15-100A5V	PX4[*]9S20-100A5V
0 to 150	0 to 10.3	PX4[*]9S15-150A5V	PX4[*]9S20-150A5V
0 to 250	0 to 17.2	PX4[*]9S15-250A5V	PX4[*]9S20-250A5V
0 to 500	0 to 34.5	PX4[*]9S15-500A5V	PX4[*]9S20-500A5V
0 to 600	0 to 41.4	PX4[*]9S15-600A5V	

[*] Select Electrical Termination
0 (PX409S) = 2 m (6') cable**
1 (PX419S) = mini DIN connector (mating connector supplied)
2 (PX429S) = Twist Lock connector (mating connector PT06F10-6S not included)
5 (PX459S) = M12 connector (mating connector not included)
**** To order with a ½ NPT conduit fitting, specify model PX409CS.**
To order 0 to 10 Vdc output, change "5V" to "10V", no extra charge.
Ordering Examples: **PX409S15-005G5V**, 2 m (6') cable termination, 1.5" Tri-Grip fitting, 5 psig range, 0 to 5 Vdc output.
PX419S20-10WG5V, mini DIN connector, 2" Tri-Grip fitting, 10 inH₂O range, 0 to 5 Vdc output.
PX429S15-050G10V, Twist-lock connector, 1.5" Tri-Grip fitting, 50 psig range, 0 to 10 Vdc output, mating connector sold separately, **PT06F10-6S**.
PX459S15-100G5V, M12 connector, 1.5" Tri-Grip fitting, 100 psig range, 0 to 5 Vdc output.

Electrical Terminations

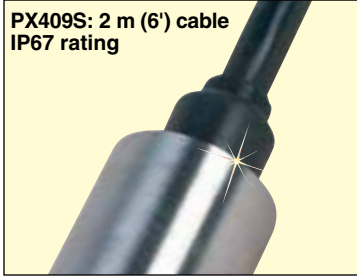

Specifications (4 to 20 mA Output)

Output: 4 to 20 mA
Supply Voltage: 9 to 30 Vdc
 [9 to 20 Vdc above 105°C (229°F)]
 max loop res $\Omega = (V_s - 90) \times 50$
Accuracy: $\pm 0.08\%$ BSL (linearity,
 hysteresis repeatability combined)

Zero Balance: $\pm 0.5\%$ FS typical 1%
 max (For ranges ≤ 2.5 psi $\pm 1\%$
 typ $\pm 2\%$ max)
Span Setting: $\pm 0.5\%$ FS typical 1%
 max (For ranges ≤ 2.5 psi $\pm 1\%$ typ
 2% max) Calibrated in horizontal
 position

**4 to 20 mA
Output**

To Order			
Range		1½" Tri-Grip™ Fitting	2" Tri-Grip™ Fitting
psi	bar		
Gage Pressure Models, 4 to 20 mA Output			
0 to 10 inH ₂ O	0 to 25 mb	PX4[*]9S15-10WGI	PX4[*]9S20-10WGI
0 to 1	0 to 69 mb	PX4[*]9S15-001GI	PX4[*]9S20-001GI
0 to 2.5	0 to 172 mb	PX4[*]9S15-2.5GI	PX4[*]9S20-2.5GI
0 to 5	0 to 345 mb	PX4[*]9S15-005GI	PX4[*]9S20-005GI
0 to 15	0 to 1	PX4[*]9S15-015GI	PX4[*]9S0-015GI
0 to 30	0 to 2.1	PX4[*]9S15-030GI	PX4[*]9S20-030GI
0 to 50	0 to 3.4	PX4[*]9S15-050GI	PX4[*]9S20-050GI
0 to 100	0 to 6.9	PX4[*]9S15-100GI	PX4[*]9S20-100GI
0 to 150	0 to 10.3	PX4[*]9S15-150GI	PX4[*]9S20-150GI
0 to 250	0 to 17.2	PX4[*]9S15-250GI	PX4[*]9S20-250GI
0 to 500	0 to 34.5	PX4[*]9S15-500GI	PX4[*]9S20-500GI
0 to 600	0 to 41.4	PX4[*]9S15-600GI	
Absolute Pressure Models, 4 to 20 mA Output			
0 to 5	0 to 345 mb	PX4[*]9S15-005AI	PX4[*]9S20-005AI
0 to 15	0 to 1	PX4[*]9S15-015AI	PX4[*]9S0-015AI
0 to 30	0 to 2.1	PX4[*]9S15-030AI	PX4[*]9S20-030AI
0 to 50	0 to 3.4	PX4[*]9S15-050AI	PX4[*]9S20-050A
0 to 100	0 to 6.9	PX4[*]9S15-100AI	PX4[*]9S20-100AI
0 to 150	0 to 10.3	PX4[*]9S15-150AI	PX4[*]9S20-150AI
0 to 250	0 to 17.2	PX4[*]9S15-250AI	PX4[*]9S20-250AI
0 to 500	0 to 34.5	PX4[*]9S15-500AI	PX4[*]9S20-500AI
0 to 600	0 to 41.4	PX4[*]9S15-600AI	

[*] Select Electrical Termination

0 (PX409S) = 2 m (6') cable**

1 (PX419S) = mini DIN connector (mating connector supplied)

2 (PX429S) = Twist Lock connector (mating connector PT06F10-6S not included)

5 (PX459S) = M12 connector (mating connector not included)

** To order with a ½ NPT conduit fitting, specify model **PX409CS**.

Ordering Examples: **PX409S15-005GI**, 2 m (6') cable termination, 1.5" Tri-Grip fitting, 5 psig range, 4 to 20 mA output.

PX419S20-10WGI, mini DIN connector, 2" Tri-Grip fitting, 10 inH₂O range, 4 to 20 mA output.

PX429S15-050GI, Twist-lock connector, 1.5" Tri-Grip fitting, 50 psig range, 4 to 20 mA output, mating connector sold separately, **PT06F10-6S**.

PX459S15-100GI, M12 connector, 1.5" Tri-Grip fitting, 100 psig range, 4 to 20 mA output.

High Accuracy Pressure Transducers

Piezoresistive Design With High Temperature Performance

All images shown smaller than actual size.

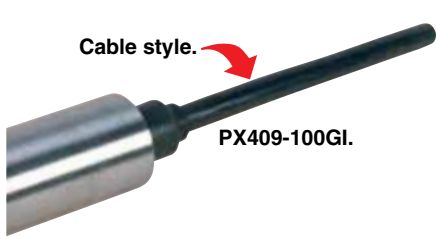

PX409 Cable Connection			
Color	mV	5/10V	mA
Black	- EXC	Common	- Supply
White	+ SIG	+ Output	NC
Green	- SIG	NC	NC
Red	+ EXC	+ EXC	+ Supply

PX419/PX459 Pinout			
Pin	mV	5/10V	mA
1	+ EXC	+ EXC	+ Supply
2	- EXC	Common	- Supply
3	+ SIG	+ Output	NC
4	- SIG	NC	NC

PX429 Twist-Lock Pinout			
Pin	mV	5/10V	mA
A	+ EXC	+ EXC	+ Supply
B	- EXC	Common	- Supply
C	+ SIG	+ Output	NC
D	- SIG	NC	NC
E	NC	NC	NC
F	NC	NC	NC

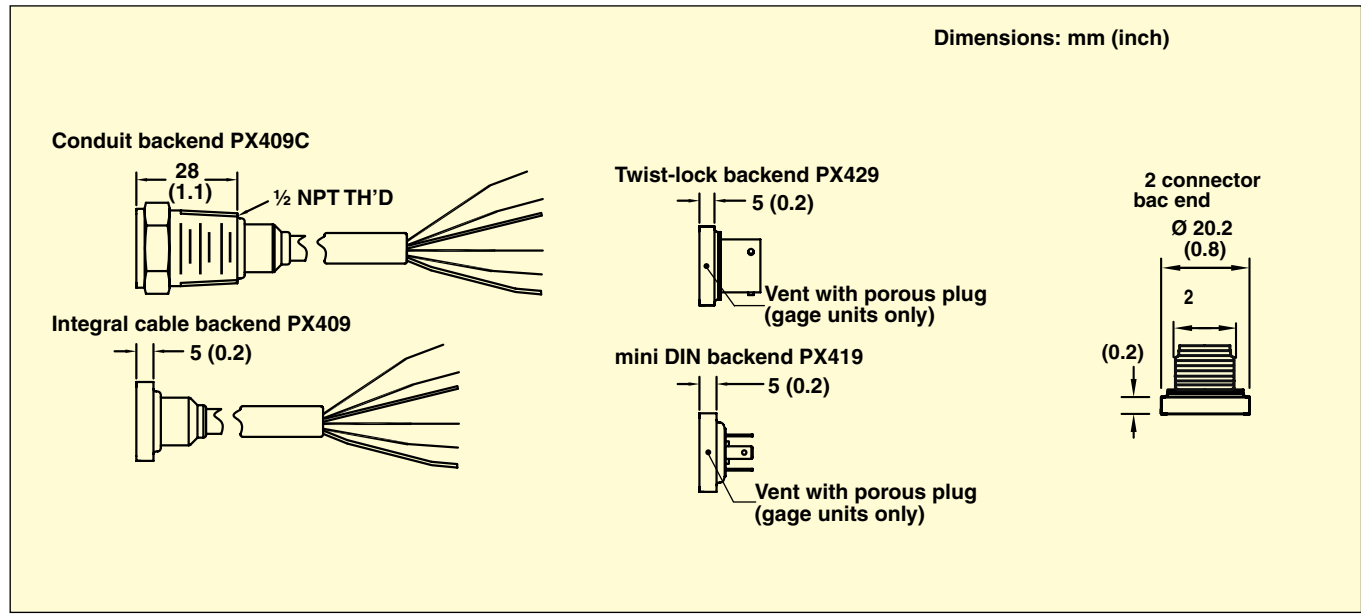

Compatible Meters and Accessories

Meters	
Model No.	Description
DP41-S	6-digit high accuracy (0.005%) process meter for use with millivolt and strain gage bridge output models
DP41-B	6-digit high accuracy (0.005%) universal meter for use with voltage and current output models also accepts thermocouple and RTD inputs
DP25B-E	4-digit precision process meter for use with voltage and current output models
Accessories	
CX5302	Extra mini DIN connector for PX419 Series
PT06F10-6S	Mating twist lock connector for PX429 Series

M12 Cables	Description
M12C-PVC-4-S-F-5	PVC cable, straight 4-pin M12 female connector one end, flying leads one end, 5 m (16.4') long
M12C-PVC-4-R-F-5	PVC cable, right angled 4-pin M12 female connector one end, flying leads one end 5 m (16.4') long

Sanitary Pressure Transducers with Metric Ranges High 0.08% Accuracy



Gage Pressure: 25 mb to 40 bar
Absolute Pressure: 350 mb to 40 bar
Compound Gage: ±25 mbar to ±1 bar
Vacuum (Negative Gage): 0 to -25 mbar to 0 to -1 bar
Barometric Ranges: 0,550 or 880 hPa to 1100 hPa

mini DIN
style.

**1½ or 2"
Tri-Grip™ Fitting**

PXM409S Tri-Grip™ Sanitary Series



- ✓ High 0.08% Accuracy
- ✓ Solid State Sensor for Long Term Stability
- ✓ Welded Stainless Steel Construction
- ✓ 316L SS Wetted Parts
- ✓ Shock and Vibration Rated
- ✓ High Overpressure Rating
- ✓ Ruggedized with Secondary Containment System
- ✓ Industrial CE Rating

PXM419S20-001BAV, shown smaller than actual size.



The PXM409S Sanitary Metric range Series micromachined silicon transducers with 1½ or 2" sanitary fittings are ideal for pressure or level CIP applications in food processing, beverage, dairy, or bio/ pharmaceutical applications. They are also rugged enough for most industrial applications requiring a high accuracy CIP transducer. The micromachined silicon sensor provides a very stable reading with exceptional high accuracy of 0.08% and a broad compensated temperature range of -4 to 85°C on most ranges. The modular construction allows for fast delivery of most configurations and fittings. Plus, customized models also can be delivered quickly to suit your exact needs.

Operating Temperature Range:
-15 to 115°C (-5 to 240°F)

Compensated Temperature Range:

≤350 mb: 4.4 to 60°C
(40 to 140°F)

>350 mb: -4 to 85°C
(25 to 185°F)

Temperature Compensation

Zero and Span Shift Over Compensated Range:

170 mb: **Zero:** 1.00%

Span: 0.70%

= 350 mb: **Zero:** 0.80%

Span: 0.50%

> 350 mb: **Zero:** 0.50%

Span: 0.50%

550H and 880H Barometric Range:

Zero: 0.90%

Span: 0.50%

Minimum Isolation Between Case and Output Terminations:

100 M Ω @ 50 Vdc

Pressure Cycles: 1 million, minimum

Long Term Stability (1-Year):

±0.1% full scale typical

Shock: 50 g, 11 mS half sine shock, (under test)

Vibration: ±20 g (under test)

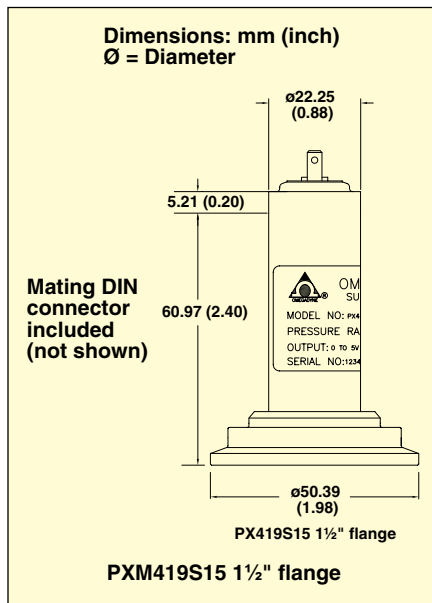

COMMON SPECIFICATIONS

Accuracy: ±0.08% Best Straight Line (Linearity, Hysteresis and Repeatability combined) Compound Gage models calibrated in positive direction only

Calibration: 5-point NIST traceable calibration with zero and span values, calibrated in horizontal direction

Zero Balance: ±0.5% full scale typical ±1% maximum (for ranges ≤170 mb ±1% typical ±2% maximum)

Span Setting: ±0.5% full scale typical ±1% maximum (for ranges ≤170 mb ±1% typical ±2% maximum)

Bandwidth: DC to 1 kHz typical
Response Time: <1 mS
Fill Fluid: NEOBEE M5 Food Grade
Approved to 3A Sanitary Specification 74-05
CE Compliant: Meets industrial emissions and immunity standard IEC61326

Environmental Protection: IP65 or IP67 depending upon electrical termination
Pressure Rating: 1½" and 2" Tri-Grip™ (compatible the Tri-Clamp®)
Fitting: 40 bar using suitable clamp

Over Pressure: 4 x rated pressure to maximum rated flange pressure
Secondary Containment: 6 x rated pressure to a maximum of 138 bar (not in clamp)
Wetted Parts: 316L SS
Weight: 285 g (10 oz)

Sanitary Pressure Transducers Gage and Absolute Pressure Ranges

10 mV/V Output

- ✓ 1½ or 2" Tri-Grip™ Fittings Available
- ✓ All Stainless Steel Construction
- ✓ High Reliability Silicon Sensor
- ✓ 3A Approved

10 mV/V Output



DP25B-S shown smaller than actual size. Visit omega.com/dp25b_s

To Order		
bar	1½" Tri-Grip™ Fitting	2" Tri-Grip™ Fitting
Gage Pressure Models, 10 mV/V Output		
0 to 25 mb	PXM4[*]9S15-025HGV	PXM4[*]9S20-025HGV
0 to 70 mb	PXM4[*]9S15-070HGV	PXM4[*]9S20-070HGV
0 to 170 mb	PXM4[*]9S15-170HGV	PXM4[*]9S20-170HGV
0 to 350 mb	PXM4[*]9S15-350HGV	PXM4[*]9S20-350HGV
0-1 bar	PXM4[*]9S15-001BGV	PXM4[*]9S20-001BGV
0 to 2	PXM4[*]9S15-002BGV	PXM4[*]9S20-002BGV
0 to 3.5	PXM4[*]9S15-3.5BGV	PXM4[*]9S20-3.5BGV
0 to 7	PXM4[*]9S15-007BGV	PXM4[*]9S20-007BGV
0 to 10	PXM4[*]9S15-010BGV	PXM4[*]9S20-010BGV
0 to 17.5	PXM4[*]9S15-17.5BGV	PXM4[*]9S20-17.5BGV
0 to 35	PXM4[*]9S15-035BGV	PXM4[*]9S20-035BGV
0 to 40	PXM4[*]9S15-040BGV	N/A
Absolute Pressure Models, 10 mV/V Output		
0 to 350 mb	PXM4[*]9S15-350HAV	PXM4[*]9S20-350HAV
0 to 1 bar	PXM4[*]9S15-001BAV	PXM4[*]9S20-001BAV
0 to 2	PXM4[*]9S15-002BAV	PXM4[*]9S20-002BAV
0 to 3.5	PXM4[*]9S15-3.5BAV	PXM4[*]9S20-3.5BAV
0 to 7	PXM4[*]9S15-007BAV	PXM4[*]9S20-007BAV
0 to 10	PXM4[*]9S15-010BAV	PXM4[*]9S20-010BAV
0 to 17.5	PXM4[*]9S15-17.5BAV	PXM4[*]9S20-17.5BAV
0 to 35	PXM4[*]9S15-035BAV	PXM4[*]9S20-035BAV
0 to 40	PXM4[*]9S15-040BAV	N/A

Comes complete with 5-point NIST traceable calibration.
 [*] Select electrical termination, no extra charge.
 Insert "0" for 2 m (9') cable with flying leads.
 For cable with ½ NPT conduit connector order model PXM409CS, no extra charge.
 Insert "1" for mini DIN cable (mating connector included).
 Insert "5" for M12 connector, M12 cables sold separately (see below).
 Custom configurations also available, see omega.com/pxconfig
Ordering Examples: PXM409S15-350HGV, 2 m (9') cable termination, 1.5" Tri-Grip fitting, 350 mb range, 10 mV/V output.
 PXM419S20-001BAV, mini-DIN connector, 2" Tri-Grip fitting, 0 to 1 bar absolute range, 10 mV/V output.
 PXM459S15-007BGI, M12 connector, 1.5" Tri-Grip fitting, 7 bar range, 10 mV/V output.

Sanitary Pressure Transducers

Compound, Vacuum and Barometric Ranges

Specifications (mV/V Output)

Output: 10 mV/V: Ratiometric
5 to 10 Vdc

Supply: 5 to 10 Vdc

Accuracy: ±0.08% BSL (linearity, hysteresis repeatability combined)
compound gage models calibrated in positive direction only

Electrical Terminations

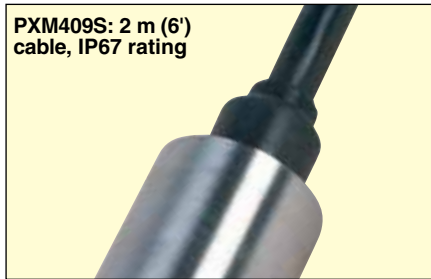

To Order		
Range	1½" Tri-Grip™ Fitting	2" Tri-Grip™ Fitting
mbar		
Compound Gage Ranges		
± 25 mbar	PXM4[*]9S15-025HCGV	PXM4[*]9S20-025HCGV
± 70 mbar	PXM4[*]9S15-070HCGV	PXM4[*]9S20-070HCGV
± 170 mbar	PXM4[*]9S15-170HCGV	PXM4[*]9S20-170HCGV
± 350 mbar	PXM4[*]9S15-350HCGV	PXM4[*]9S20-350HCGV
± 1 bar	PXM4[*]9S15-001BCGV	PXM4[*]9S20-001BCGV
Vacuum Ranges (Negative Gage, 0 = Ambient)		
0 to -25 mbar	PXM4[*]9S15-025HVV	PXM4[*]9S20-025HVV
0 to -70 mbar	PXM4[*]9S15-070HVV	PXM4[*]9S20-070HVV
0 to -170 mbar	PXM4[*]9S15-170HVV	PXM4[*]9S20-170HVV
0 to -350 mbar	PXM4[*]9S15-350HVV	PXM4[*]9S20-350HVV
0 to -1 bar	PXM4[*]9S15-001BVV	PXM4[*]9S20-001BVV
Barometric Ranges (Absolute Pressure)		
0 to 1100 hPa	PXM4[*]9S15-1100HBV	PXM4[*]9S20-1100HBV
550 to 1100 hPa	PXM4[*]9S15-550HBV	PXM4[*]9S20-550HBV
880 to 1100 hPa	PXM4[*]9S15-880HBV	PXM4[*]9S20-880HBV

Accessories

Model No.	Description
M12C-PVC-4-S-F-5	PVC cable, straight 4-pin M12 female connector one end, flying leads one end, 5 m (16.4') long, for PXM459
M12C-PVC-4-R-F-5	PVC cable, right angled 4-pin M12 female connector one end, flying leads one end, 5 m (16.4') long, for PXM459

Comes complete with 5-point NIST traceable calibration.

[*] Select electrical termination, no extra charge.

Insert "0" for 2 m (9') cable with flying leads.

For ½ NPT conduit connector order model PXM409CS, no extra charge.

Insert "1" for mini DIN cable (mating connector included).

Insert "5" for M12 connector, M12 cables sold separately (see below).

Custom configurations also available, see omega.com/pxconfig

Ordering Examples: PXM409S15-170HCGV, cable termination, 1.5" Tri-grip fitting, ± 170 mbar range, 10 mV/V output.

PXM459S20-001BVV, M12 termination, 2" Tri-grip fitting, 0 to -1 bar (vacuum) range, 10 mV/V output.

PXM419S15-550HBV, mini-DIN termination, 1.5" Tri-grip fitting, 550 to 1100 hPa calibrated barometric range, 10 mV/V output.

Sanitary Pressure Transducers Gages and Absolute Ranges

**0 to 10 Vdc
Output**

0 to 10 Vdc Output

- ✓ 1½ or 2" Tri-Grip™ Fittings Available
- ✓ All Stainless Steel Construction
- ✓ High Reliability Silicon Sensor
- ✓ 3A Approved



DP25B-E shown smaller than actual size. Visit omega.com/dp25b



DP41-E shown smaller than actual size. Visit omega.com/dp41

To Order		
bar	1½" Tri-Grip™ Fitting	2" Tri-Grip™ Fitting
Gage Pressure Models, 0 to 10 Vdc Output		
0 to 25 mb	PXM4[*]9S15-025HG10V	PXM4[*]9S20-025HG10V
0 to 70 mb	PXM4[*]9S15-070HG10V	PXM4[*]9S20-070HG10V
0 to 170 mb	PXM4[*]9S15-170HG10V	PXM4[*]9S20-170HG10V
0 to 350 mb	PXM4[*]9S15-350HG10V	PXM4[*]9S20-350HG10V
0 to 1 bar	PXM4[*]9S15-001BG10V	PXM4[*]9S20-001BG10V
0 to 2	PXM4[*]9S15-002BG10V	PXM4[*]9S20-002BG10V
0 to 3.5	PXM4[*]9S15-3.5BG10V	PXM4[*]9S20-3.5BG10V
0 to 7	PXM4[*]9S15-007BG10V	PXM4[*]9S20-007BG10V
0 to 10	PXM4[*]9S15-010BG10V	PXM4[*]9S20-010BG10V
0 to 17.5	PXM4[*]9S15-17.5BG10V	PXM4[*]9S20-17.5BG10V
0 to 35	PXM4[*]9S15-035BG10V	PXM4[*]9S20-035BG10V
0 to 40	PXM4[*]9S15-040BG10V	N/A
Absolute Pressure Models, 0 to 10 Vdc Output		
0 to 350 mb	PXM4[*]9S15-350HA10V	PXM4[*]9S20-350HA10V
0 to 1 bar	PXM4[*]9S15-001BA10V	PXM4[*]9S20-001BA10V
0 to 2	PXM4[*]9S15-002BA10V	PXM4[*]9S20-002BA10V
0 to 3.5	PXM4[*]9S15-3.5BA10V	PXM4[*]9S20-3.5BA10V
0 to 7	PXM4[*]9S15-007BA10V	PXM4[*]9S20-007BA10V
0 to 10	PXM4[*]9S15-010BA10V	PXM4[*]9S20-010BA10V
0 to 17.5	PXM4[*]9S15-17.5BA10V	PXM4[*]9S20-17.5BA10V
0 to 35	PXM4[*]9S15-035BA10V	PXM4[*]9S20-035BA10V
0 to 40	PXM4[*]9S15-040BA10V	N/A

Comes complete with 5-point NIST traceable calibration.

[*] Select electrical termination, no extra charge.

Insert "0" for 2 m (9') cable with flying leads.

For cable with ½ NPT conduit connector order model PXM409CS, no extra charge.

Insert "1" for mini DIN cable (mating connector included).

Insert "5" for M12 connector, M12 cables sold separately (see below).

Custom configurations also available, see omega.com/pxconfig

Ordering Examples: PXM409S15-350HG10V, 2 m (9') cable termination, 1.5" Tri-Grip fitting, 350 mb range, 0 to 10 Vdc.

PXM419S20-001BA10V, mini-DIN connector, 2" Tri-Grip fitting, 0 to 1 bar absolute range, 0 to 10 Vdc.

PXM459S15-007BG10V, M12 connector, 1.5" Tri-Grip fitting, 7 bar range, 0 to 10 Vdc.

Sanitary Pressure Transmitters

Compound, Vacuum and Barometric Ranges

**Specifications
(Amplified Voltage Output)
Output/Supply (0 to 10 Vdc):**
15 to 30 Vdc

Accuracy: $\pm 0.08\%$ BSL (linearity, hysteresis repeatability combined) compound gage models calibrated in positive direction only

Electrical Terminations



To Order		
Range	1½" Tri-Grip™ Fitting	2" Tri-Grip™ Fitting
Compound Gage Ranges		
± 25 mbar	PXM4[*]9S15-025HCG10V	PXM4[*]9S20-025HCG10V
± 70 mbar	PXM4[*]9S15-070HCG10V	PXM4[*]9S20-070HCG10V
± 170 mbar	PXM4[*]9S15-170HCG10V	PXM4[*]9S20-170HCG10V
± 350 mbar	PXM4[*]9S15-350HCG10V	PXM4[*]9S20-350HCG10V
± 1 bar	PXM4[*]9S15-001BCG10V	PXM4[*]9S20-001BCG10V
Vacuum Ranges (Negative Gage, 0 = Ambient)		
0 to -25 mbar	PXM4[*]9S15-025HV10V	PXM4[*]9S20-025HV10V
0 to -70 mbar	PXM4[*]9S15-070HV10V	PXM4[*]9S20-070HV10V
0 to -170 mbar	PXM4[*]9S15-170HV10V	PXM4[*]9S20-170HV10V
0 to -350 mbar	PXM4[*]9S15-350HV10V	PXM4[*]9S20-350HV10V
0 to -1 bar	PXM4[*]9S15-001BV10V	PXM4[*]9S20-001BV10V
Barometric Ranges (Absolute Pressure)		
0 to 1100 hPa	PXM4[*]9S15-1100HB10V	PXM4[*]9S20-1100HB10V
550 to 1100 hPa	PXM4[*]9S15-550HB10V	PXM4[*]9S20-550HB10V
880 to 1100 hPa	PXM4[*]9S15-880HB10V	PXM4[*]9S20-880HB10V

Accessories

Model No.	Description
M12C-PVC-4-S-F-5	PVC cable, straight 4-pin M12 female connector one end, flying leads one end, 5 m (16.4') long, for PXM459
M12C-PVC-4-R-F-5	PVC cable, right angled 4-pin M12 female connector one end, flying leads one end, 5 m (16.4') long, for PXM459

Comes complete with 5-point NIST traceable calibration.

[*] Select electrical termination, no extra charge.

Insert "0" for 2 m (9') cable with flying leads

For cable with ½ NPT conduit connector order model PXM409CS, no extra charge.

Insert "1" for mini DIN cable (mating connector included).

Insert "5" for M12 connector, M12 cables sold separately (see below).

Custom configurations also available, see omega.com/pxconfig

Ordering Examples: PXM409S15-170HCG10V, cable termination, 1.5" Tri-grip fitting, ± 170 mbar range, 0 to 10 Vdc output.

PXM459S20-001BV10V, M12 termination, 2" Tri-grip fitting, 0 to -1 bar (vacuum) range, 0 to 10 Vdc output.

PXM419S15-550HB10V, mini DIN termination, 1.5" Tri-grip fitting, 550 to 1100 hPa calibrated barometric range, 0 to 10 Vdc output.

Sanitary Pressure Transducers Gages and Absolute Ranges

4 to 20 mA
Output

4 to 20 mA

- ✓ 1½ or 2" Tri-Grip™ Fittings Available
- ✓ All Stainless Steel Construction
- ✓ High Reliability Silicon Sensor
- ✓ 3A Approved



DP25B-E shown smaller than actual size. Visit omega.com/dp25b



DP41-E shown smaller than actual size. Visit omega.com/dp41

To Order		
bar	1½" Tri-Grip™ Fitting	2" Tri-Grip™ Fitting
Gage Pressure Models, 4 to 20 mA Output		
0 to 25 mb	PXM4[*]9S15-025HGI	PXM4[*]9S20-025HGI
0 to 70 mb	PXM4[*]9S15-070HGI	PXM4[*]9S20-070HGI
0 to 170 mb	PXM4[*]9S15-170HGI	PXM4[*]9S20-170HGI
0 to 350 mb	PXM4[*]9S15-350HGI	PXM4[*]9S20-350HGI
0-1 bar	PXM4[*]9S15-001BGI	PXM4[*]9S20-001BGI
0 to 2	PXM4[*]9S15-002BGI	PXM4[*]9S20-002BGI
0 to 3.5	PXM4[*]9S15-3.5BGI	PXM4[*]9S20-3.5BGI
0 to 7	PXM4[*]9S15-007BGI	PXM4[*]9S20-007BGI
0 to 10	PXM4[*]9S15-010BGI	PXM4[*]9S20-010BGI
0 to 17.5	PXM4[*]9S15-17.5BGI	PXM4[*]9S20-17.5BGI
0 to 35	PXM4[*]9S15-035BGI	PXM4[*]9S20-035BGI
0 to 40	PXM4[*]9S15-040BGI	N/A
Absolute Pressure Models, 4 to 20 mA Output		
0 to 350 mb	PXM4[*]9S15-350HAI	PXM4[*]9S20-350HAI
0-1 bar	PXM4[*]9S15-001BAI	PXM4[*]9S20-001BAI
0 to 2	PXM4[*]9S15-002BAI	PXM4[*]9S20-002BAI
0 to 3.5	PXM4[*]9S15-3.5BAI	PXM4[*]9S20-3.5BAI
0 to 7	PXM4[*]9S15-007BAI	PXM4[*]9S20-007BAI
0 to 10	PXM4[*]9S15-010BAI	PXM4[*]9S20-010BAI
0 to 17.5	PXM4[*]9S15-17.5BAI	PXM4[*]9S20-17.5BAI
0 to 35	PXM4[*]9S15-035BAI	PXM4[*]9S20-035BAI
0 to 40	PXM4[*]9S15-040BAI	N/A

Comes complete with 5-point NIST traceable calibration.

[*] Select electrical termination, no extra charge.

Insert "0" for 2 m (9') cable with flying leads.

For cable with ½ NPT conduit connector order model PXM409CS, no extra charge

Insert "1" for mini DIN cable (mating connector included)

Insert "5" for M12 connector, M12 cables sold separately (see below)

Custom configurations also available, see omega.com/pxconfig

Ordering Examples: PXM409S15-350HGI, 2 m (9') cable termination, 1.5" Tri-Grip fitting, 350 mbar range, 4 to 20 mA output.

PXM419S20-001BAI, mini-DIN connector, 2" Tri-Grip fitting, 0 to 1 bar absolute range, 4 to 20 mA output

PXM459S15-007BGI, M12 connector, 1.5" Tri-Grip fitting, 7 bar range, 4 to 20 mA output.

Sanitary Pressure Transmitters

Compound, Vacuum and Barometric Ranges

4 to 20 mAdc Output

Specifications

Output: 4 to 20 mAdc
Supply: 9 to 30 Vdc
 9 to 20 Vdc above 105°C (229°F)
 max loop res $\Omega = (V_s - 9) \times 50$

Accuracy: $\pm 0.08\%$ BSL (linearity, hysteresis repeatability combined)
 compound gage models calibrated in positive direction only

Electrical Terminations

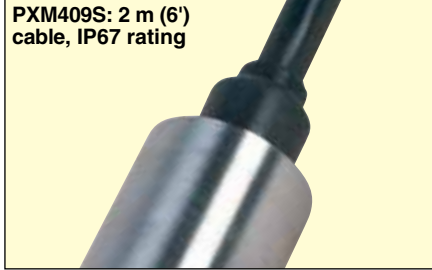

To Order		
Range	1½" Tri-Grip™ Fitting	2" Tri-Grip™ Fitting
mbar		
Compound Gage Ranges		
± 25 mbar	PXM4[*]9S15-025HCGI	PXM4[*]9S20-025HCGI
± 70 mbar	PXM4[*]9S15-070HCGI	PXM4[*]9S20-070HCGI
± 170 mbar	PXM4[*]9S15-170HCGI	PXM4[*]9S20-170HCGI
± 350 mbar	PXM4[*]9S15-350HCGI	PXM4[*]9S20-350HCGI
± 1 bar	PXM4[*]9S15-001BCGI	PXM4[*]9S20-001BCGI
Vacuum Ranges (Negative Gage, 0 = Ambient)		
0 to -25 mbar	PXM4[*]9S15-025HVI	PXM4[*]9S20-025HVI
0 to -70 mbar	PXM4[*]9S15-070HVI	PXM4[*]9S20-070HVI
0 to -170 mbar	PXM4[*]9S15-170HVI	PXM4[*]9S20-170HVI
0 to -350 mbar	PXM4[*]9S15-350HVI	PXM4[*]9S20-350HVI
0 to -1 bar	PXM4[*]9S15-001BVI	PXM4[*]9S20-001BVI
Barometric Ranges (Absolute Pressure)		
0 to 1100 hPa	PXM4[*]9S15-1100HBI	PXM4[*]9S20-1100HBI
550 to 1100 hPa	PXM4[*]9S15-550HBI	PXM4[*]9S20-550HBI
880 to 1100 hPa	PXM4[*]9S15-880HBI	PXM4[*]9S20-880HBI

Accessories

Model No.	Description
M12C-PVC-4-S-F-5	PVC cable, straight 4-pin M12 female connector one end, flying leads one end, 5 m (16.4') long, for PXM459
M12C-PVC-4-R-F-5	PVC cable, right angled 4-pin M12 female connector one end, flying leads one end, 5 m (16.4') long, for PXM459

Comes complete with 5-point NIST traceable calibration.

[*] Select electrical termination, no extra charge.

Insert "0" for 2 m (9') cable with flying leads.

For cable with ½ NPT conduit connector order model PXM409CS, no extra charge.

Insert "1" for mini DIN cable (mating connector included).

Insert "5" for M12 connector, M12 cables sold separately.

Custom configurations also available, see omega.com/pxconfig

Ordering Examples: PXM409S15-170HCGI, cable termination, 1.5" Tri-grip fitting, ± 170 mbar range, 4 to 20 mA output.

PXM459S20-001BVI, M12 termination, 2" Tri-grip fitting, 0 to -1 bar (vacuum) range, 4 to 20 mA output.

PXM419S15-550HBI, mini DIN termination, 1.5" Tri-grip fitting, 550 to 1100 hPa calibrated barometric range, 4 to 20 mA output.

High Accuracy Pressure Transducers

Piezoresistive Design With High Temperature Performance

All images shown smaller than actual size.

Cable style.



PXM409S Series

PXM409S Cable Connection			
Color	mV	5/10V	mA
Black	- EXC	Common	- Supply
White	+ SIG	+ Output	NC
Green	- SIG	NC	NC
Red	+ EXC	+ EXC	+ Supply

mini DIN and M12 style.



PXM419S Series

PXM459S M12 connector.

PXM419S/PXM459S Pinout			
Pin	mV	5/10V	mA
1	+ EXC	+ EXC	+ Supply
2	- EXC	Common	- Supply
3	+ SIG	+ Output	NC
4	- SIG	NC	NC

NC = No Connection.

Conduit backend PXM409C

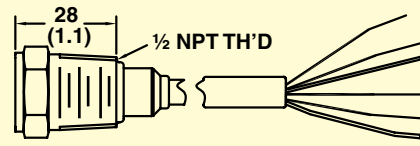

Integral cable backend PXM409S

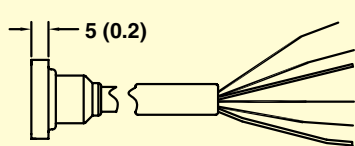

mini DIN backend PXM419S

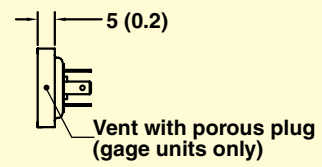

M12 connector backend PXM459S

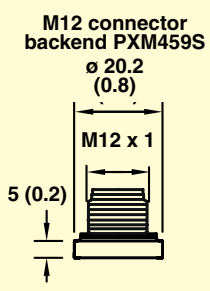

Dimensions: mm (inch)

Compatible Meters and Accessories

Meters	
Model No.	Description
DP41-S	6-digit high accuracy (0.005%) process meter for use with milli voltage and strain gage bridge output models
DP41-E	6-digit high accuracy (0.005%) meter for use with voltage and current output models
DP25B-E	4-digit precision process meter for use with voltage and current output models
Accessories	
CX5302	Extra mini DIN connector for PXM419S Series
M12C-PVC-4-S-F-5	PVC cable, straight 4-pin M12 female connector one end, flying leads one end, 5 m (16.4') long, for PXM459S
M12C-PVC-4-R-F-5	PVC cable, right angled 4-pin M12 female connector one end, flying leads one end 5 m (16.4') long, for PXM459S

USB Output Sanitary Fitting Pressure Transducer Connect Directly to Your PC or Laptop



**Gage, Absolute, Compound Gage,
Vacuum and Barometric Pressures
10 inH₂O to 600 psi (25 mb to 41 bar)**

PX409S Sanitary USBH Series

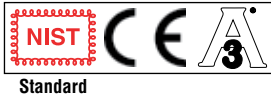

- ✓ High Speed 1000 Updates/Second
- ✓ Micromachined Silicon Sensor
- ✓ 316L SS Wetted Parts
- ✓ High 0.08% Accuracy
- ✓ Excellent Long Term Stability
- ✓ USB 2.0 and Below Compatible
- ✓ Standard USB Cable Termination
- ✓ Ruggedized with Secondary Containment System

The PX409S Sanitary USBH Series connects directly to your computer. The Sanitary Series is 3A approved and available with 1½" or 2" Tri-Grip™ (Tri-Clamp® compatible) fittings to work with most common applications. Free software makes data logging and charting your readings a simple task. The micromachined silicon design is ideal for pressure or level applications in laboratory, test platforms, or bio/pharmaceutical applications as well as industrial applications that require a rugged, high accuracy transducer. The micromachined silicon sensor provides a very stable transducer with exceptional high accuracy of 0.08% typical and a broad compensated range (see specs for details). The modular construction allows for fast delivery of most configurations and fittings.

Specifications

Accuracy: 0.08% typical best straight line, 0.14% maximum (linearity, hysteresis and repeatability combined) compound gage models calibrated in positive direction only
Calibration: 5-point NIST traceable calibration with zero and span values calibrated in horizontal direction
Zero Balance: ±0.5% full scale typical ±1% maximum (±1% typical, ±2% maximum for 2.5 psi and below)

PX409S15-015CGUSBH,
1.5" flange, ±15 psi,
USB output.



2 m (6') integral
USB cable connects
directly to your PC.



PX409S20-015GUSBH,
2" flange, 0 to 15 psi,
USB output.

FREE Omega™ USBH Downloadable Software!

Omega is excited to announce the release of a major software update for USB Transducers! The fresh look and added features add even more value and flexibility to your transducer's performance. Free Omega PC software takes the data from the transducer directly to the digital domain, turning your laptop or Windows® tablet (with USB connection) into a virtual meter, chart recorder, or data logger.

Also included are .NET APIs and a set for command-line access. Visit <ftp://ftp.omega.com/public/DASGroup/products/USBH/> to download your free copy.*

*Includes software to run TRH Central compatible devices.

Metric threads and ranges available.

Span Setting: ±0.5% full scale typical ±1% maximum (±1% typical, ±2% maximum for 2.5 psi and below). Calibrated in vertical direction with fitting down

Operating Temperature Range: -15 to 95°C (-5 to 203°F)

Compensated Temperature Range:
Ranges ≤5 psi: 4.4 to 60°C (40 to 140°F)
Ranges >5 psi: -4 to 85°C (25 to 185°F)

Temperature Compensation Zero and Span Shift Over Compensated Range:
Ranges ≤2.5 psi:
Zero: 1.00%
Span: 0.70%

Range = 5 psi:

Zero: 0.80%

Span: 0.50%

Ranges >5 psi:

Zero: 0.50%

Span: 0.50%

26B/26HB Barometric Range:

Zero: 0.90%

Span: 0.50%

Minimum Isolation:

100 MΩ @ 50 Vdc case to sensor
2 MΩ @ 50 Vdc case to output terminations

Pressure Cycles: >1million minimum

Long Term Stability (1 Year):

±0.1% full scale typical

Shock: 50 g, 11 mS half sine shock,

(under test)

Vibration: ±20 g (under test)

Bandwidth: DC to 1000 updates per second typical (±3%)

A to D Conversion: 24 bit

Fill Fluid: NEOBEE

M5 food grade

Approved to 3A Sanitary Specification 74-05

CE Compliant: Meets industrial emissions and immunity standard IEC61326

Environmental Protection: IP65

Pressure Rating:

1½" and 2" Tri-Grip™

Fitting: 600 psi using suitable clamp

Over Pressure: 4 x rated pressure to maximum rated flange pressure

Secondary Containment: 6 x rated

pressure to a maximum of 2000 psi (not in clamp)

Wetted Parts: 316L stainless steel

Weight: 285 g (10 oz)

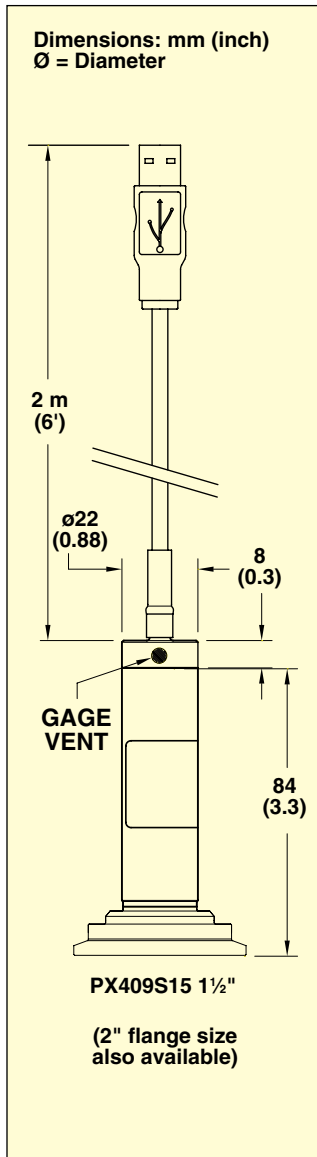

To Order			
Range psi	Range bar	1.5" Tri-Grip Models	2.0" Tri-Grip Models
Gage Pressure			
0 to 10 inH ₂ O	0 to 25 mb	PX409S15-10WGUSBH	PX409S20-10WGUSBH
0 to 1	0 to 69 mb	PX409S15-001GUSBH	PX409S20-001GUSBH
0 to 2.5	0 to 172 mb	PX409S15-2.5GUSBH	PX409S20-2.5GUSBH
0 to 5	0 to 345 mb	PX409S15-005GUSBH	PX409S20-005GUSBH
0 to 15	0 to 1	PX409S15-015GUSBH	PX409S20-015GUSBH
0 to 30	0 to 2.1	PX409S15-030GUSBH	PX409S20-030GUSBH
0 to 50	0 to 3.4	PX409S15-050GUSBH	PX409S20-050GUSBH
0 to 100	0 to 6.9	PX409S15-100GUSBH	PX409S20-100GUSBH
0 to 150	0 to 10.3	PX409S15-150GUSBH	PX409S20-150GUSBH
0 to 250	0 to 17.2	PX409S15-250GUSBH	PX409S20-250GUSBH
0 to 500	0 to 34.5	PX409S15-500GUSBH	PX409S20-500GUSBH
0 to 600	0 to 41.4	PX409S15-600GUSBH	—
Absolute Pressure			
0 to 5	0 to 345 mb	PX409S15-005AUSBH	PX409S20-005AUSBH
0 to 15	0 to 1	PX409S15-015AUSBH	PX409S20-015AUSBH
0 to 30	0 to 2.1	PX409S15-030AUSBH	PX409S20-030AUSBH
0 to 50	0 to 3.4	PX409S15-050AUSBH	PX409S20-050AUSBH
0 to 100	0 to 6.9	PX409S15-100AUSBH	PX409S20-100AUSBH
0 to 150	0 to 10.3	PX409S15-150AUSBH	PX409S20-150AUSBH
0 to 250	0 to 17.2	PX409S15-250AUSBH	PX409S20-250AUSBH
0 to 500	0 to 34.5	PX409S15-500AUSBH	PX409S20-500AUSBH
0 to 600	0 to 41.4	PX409S15-600AUSBH	—
Vacuum Ranges (Negative Gage Pressure)			
0 to -10 inH ₂ O	0 to -25 mb	PX409S15-10WVUSBH	PX409S20-10WVUSBH
0 to -1 psi	0 to -69 mb	PX409S15-001VUSBH	PX409S20-001VUSBH
0 to -2.5 psi	0 to -172 mb	PX409S15-2.5VUSBH	PX409S20-2.5VUSBH
0 to -5 psi	0 to -345 mb	PX409S15-005VUSBH	PX409S20-005VUSBH
0 to -15 psi	0 to -1	PX409S15-015VUSBH	PX409S20-015VUSBH
Compound Gage Ranges			
±10 inH ₂ O	±25 mb	PX409S15-10WCGUSBH	PX409S20-10WCGUSBH
±1 psi	±69 mb	PX409S15-001CGUSBH	PX409S20-001CGUSBH
±2.5 psi	±172 mb	PX409S15-2.5CGUSBH	PX409S20-2.5CGUSBH
±5 psi	±345 mb	PX409S15-005CGUSBH	PX409S20-005CGUSBH
±15 psi	±1	PX409S15-015CGUSBH	PX409S20-015CGUSBH
Barometric Ranges (Absolute Pressure)			
0 to 32 inHg	—	PX409S15-32BUSBH	PX409S20-32BUSBH
16 to 32 inHg	—	PX409S15-16BUSBH	PX409S20-16BUSBH
26 to 32 inHg	—	PX409S15-26BUSBH	PX409S20-26BUSBH
—	0 to 1100 hPa	PX409S15-32HBUSBH	PX409S20-32HBUSBH
—	550 to 1100 hPa	PX409S15-16HBUSBH	PX409S20-16HBUSBH
—	880 to 1100 hPa	PX409S15-26HBUSBH	PX409S20-26HBUSBH

Comes complete with 5-point NIST traceable calibration certificate, cable with USB connector, and free downloadable PC software.

Ordering Examples: PX409S15-015GUSBH, 1.5" Tri-Grip fitting, 2 m (6') cable termination with USB termination, 15 psi gage range, USB Output.

PX409S20-16BUSBH, 2" Tri-Grip fitting, 2 m (6') cable termination with USB termination, 16 to 32 inHg barometric range, USB Output.

Omega USBH Major Software Update

Omega is excited to announce the release of a major software update for USB Transducers! The fresh look and added features add even more value and flexibility to your transducer's performance. Free Omega PC software takes the data from the transducer directly to the digital domain, turning your laptop or Windows® tablet (with USB connection) into a virtual meter, chart recorder, or data logger. Also included are .NET APIs and a set for command-line access.

Visit <ftp://ftp.omega.com/public/DASGroup/products/USBH/> to download your free copy.*

* Includes software to run TRH Central compatible devices.

Charting Window – The addition of a charting window allows you to see your data graphed in real time. The Y axis is configurable to allow simultaneous graphing of multiple engineering units. You can output the image of your data to a png file.

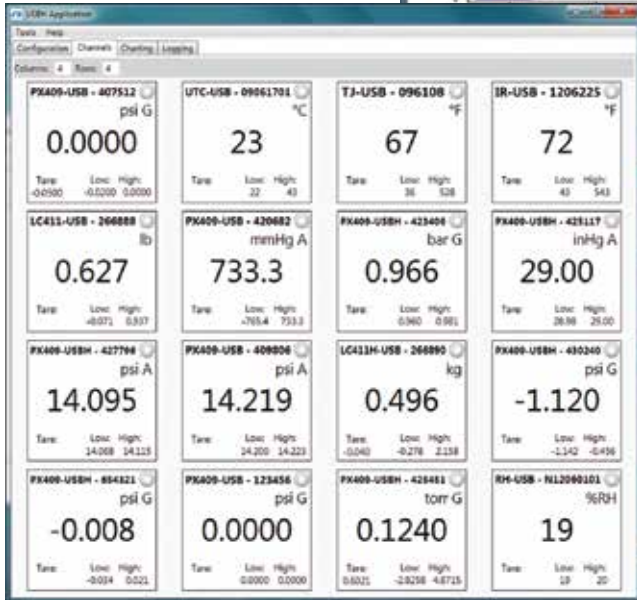
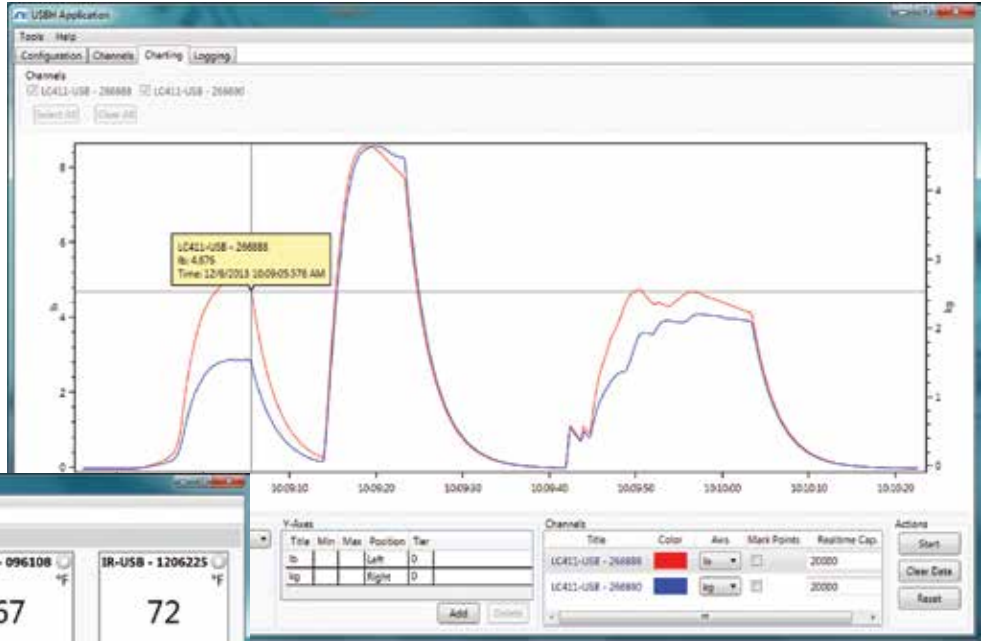

Channels Window – Display data from all of your sensors simultaneously. Each channel has configurable user alarms, three data filters, tare, resettable low/high indication, and sample rates ranging from 30 minutes to 1000 Hz.

Logging Window – A new xls filetype output option presents preformatted data for readability. In addition, Live Statistics are displayed, including the sensor information, the start/stop time, the number of samples taken, the current reading, and the High/Low readings. With the logging window, you can capture your data for later analysis.

PX409-USBH-425117	
Units	psi
Count	10
Last	14.2349
Low	14.2349
High	14.2353

Support for Omega Pressure, Force, Temperature, and Humidity USB Transducers

One software package supports:

PX409-*-USB, PX409-*-USBH, LC411-*-USBH, TJ-USB, IR-USB, RH-USB and UTC-USB transducers.

