

SMD Inductors(Coils) For High Frequency(Multilayer)

Conformity to RoHS Directive

MLK Series MLK1005

FEATURES

- Supports operating frequency bands of up to 12GHz with nominal inductance values from 1 to 100nH.
- Provides high Q characteristics.
- Advanced monolithic structure is formed using a multilayering and sintering process with ceramic and conductive materials for high-frequency.
- Because the part is non-polarized, it can be used in bulk cassette loaders.
- It is a product conforming to RoHS directive.

APPLICATIONS

For high-frequency applications including mobile phones, high frequency modules (PA, VCO, FEM etc.), Bluetooth, W-LAN, UWB and tuners.

SHAPES AND DIMENSIONS

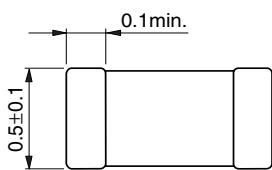
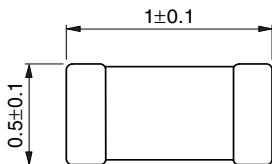

Weight: 1.0mg



RECOMMENDED PC BOARD PATTERN

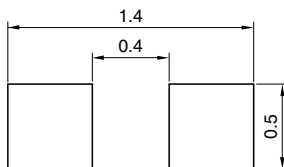

Dimensions in mm

RECOMMENDED SOLDERING CONDITION REFLOW SOLDERING

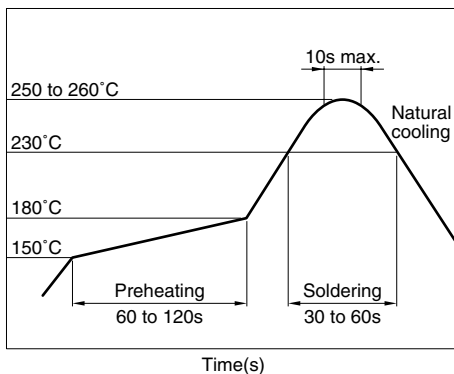

- Conformity to RoHS Directive: This means that, in conformity with EU Directive 2002/95/EC, lead, cadmium, mercury, hexavalent chromium, and specific bromine-based flame retardants, PBB and PBDE, have not been used, except for exempted applications.

- Please contact our Sales office when your application are considered the following:
The device's failure or malfunction may directly endanger human life (e.g. application for automobile/aircraft/medical/nuclear power devices, etc.)

- All specifications are subject to change without notice.

PRODUCT IDENTIFICATION

MLK	1005	S	2N2	S	T
(1)	(2)	(3)	(4)	(5)	(6)

(1) Series name

(2) Dimensions

1005	1.0×0.5mm (L×W)
------	-----------------

(3) Material code

(4) Inductance value

2N2	2.2nH
12N	12nH
R10	100nH

(5) Inductance tolerance

S	±0.3nH
D	±0.5nH
J	±5%

(6) Packaging style

T	Taping (reel)
---	---------------

SPECIFICATIONS

Operating temperature range	-55 to +125°C
Storage temperature range	-55 to +125°C [Unit of product]

PACKAGING STYLE AND QUANTITIES

Packaging style	Quantity
Taping	10000 pieces/reel

HANDLING AND PRECAUTIONS

- Before soldering, be sure to preheat components.
The preheating temperature should be set so that the temperature difference between the solder temperature and product temperature does not exceed 150°C.
- After mounting components onto the printed circuit board, do not apply stress through board bending or mishandling.
- When hand soldering, apply the soldering iron to the printed circuit board only. Temperature of the iron tip should not exceed 350°C. Soldering time should not exceed 3 seconds.

ELECTRICAL CHARACTERISTICS

Inductance (nH)	Inductance tolerance	Q min.	Test frequency L, Q (MHz)	Self-resonant frequency (GHz)		DC resistance (Ω)		Rated current (mA)max.	Part No.
				min.	typ.	max.	typ.		
1.0	± 0.3 nH	5	100	12.0	16.9	0.10	0.05	500	MLK1005S1N0ST
1.2	± 0.3 nH	5	100	11.0	14.4	0.12	0.05	500	MLK1005S1N2ST
1.5	± 0.3 nH	6	100	9.5	12.2	0.15	0.06	500	MLK1005S1N5ST
1.8	± 0.3 nH	6	100	8.5	10.9	0.17	0.07	500	MLK1005S1N8ST
2.2	± 0.3 nH	6	100	8.0	9.6	0.18	0.08	500	MLK1005S2N2ST
2.7	± 0.3 nH	6	100	7.5	9.1	0.20	0.10	500	MLK1005S2N7ST
3.3	± 0.3 nH	7	100	7.0	8.3	0.22	0.11	400	MLK1005S3N3ST
3.9	± 0.3 nH	7	100	6.5	7.8	0.25	0.12	400	MLK1005S3N9ST
4.7	± 0.3 nH	7	100	6.0	6.9	0.28	0.13	400	MLK1005S4N7ST
5.6	± 0.5 nH	7	100	5.7	6.7	0.30	0.15	400	MLK1005S5N6DT
6.8	± 0.5 nH	7	100	5.5	6.3	0.35	0.18	400	MLK1005S6N8DT
8.2	± 0.5 nH	7	100	5.0	6.0	0.38	0.21	350	MLK1005S8N2DT
10	$\pm 5\%$	7	100	4.7	5.2	0.42	0.23	350	MLK1005S10NJT
12	$\pm 5\%$	7	100	4.3	5.3	0.47	0.27	350	MLK1005S12NJT
15	$\pm 5\%$	7	100	4.0	4.8	0.50	0.33	300	MLK1005S15NJT
18	$\pm 5\%$	7	100	4.0	4.7	0.60	0.38	250	MLK1005S18NJT
22	$\pm 5\%$	7	100	3.5	4.4	0.70	0.46	200	MLK1005S22NJT
27	$\pm 5\%$	7	100	3.0	3.9	0.80	0.53	200	MLK1005S27NJT
33	$\pm 5\%$	7	100	2.5	3.5	0.90	0.59	200	MLK1005S33NJT
39	$\pm 5\%$	6	100	2.0	3.1	1.00	0.65	200	MLK1005S39NJT
47	$\pm 5\%$	6	100	1.8	3.0	1.20	0.74	200	MLK1005S47NJT
56	$\pm 5\%$	6	100	1.5	2.6	1.30	0.84	200	MLK1005S56NJT
68	$\pm 5\%$	6	100	1.4	2.4	1.50	1.01	150	MLK1005S68NJT
82	$\pm 5\%$	6	100	1.3	2.2	1.80	1.39	150	MLK1005S82NJT
100	$\pm 5\%$	6	100	1.1	1.9	2.20	1.60	100	MLK1005SR10JT

- Test equipment

- Inductance Q : HP4291A+16193A, or equivalent

- SRF: HP8720C, or equivalent

- Rdc: YOKOGAWA TYPE7561, or equivalent

- Rated current: Value obtained when current flows and temperature has risen to 20°C.

L, Q vs. FREQUENCY CHARACTERISTICS

Part No.	Inductance(nH)typ.					Q typ.				
	500MHz	800MHz	1.8GHz	2.0GHz	2.4GHz	500MHz	800MHz	1.8GHz	2.0GHz	2.4GHz
MLK1005S1N0ST	0.9	0.9	0.9	0.9	0.9	16	20	30	32	36
MLK1005S1N2ST	1.1	1.1	1.1	1.1	1.1	15	18	28	30	33
MLK1005S1N5ST	1.4	1.4	1.4	1.4	1.4	15	19	29	31	34
MLK1005S1N8ST	1.7	1.7	1.7	1.7	1.7	16	21	32	33	37
MLK1005S2N2ST	2.0	2.0	2.0	2.0	2.1	15	19	29	31	34
MLK1005S2N7ST	2.5	2.5	2.5	2.6	2.6	17	22	33	35	39
MLK1005S3N3ST	3.1	3.1	3.1	3.1	3.2	16	20	31	32	36
MLK1005S3N9ST	3.7	3.6	3.7	3.7	3.8	17	21	32	33	37
MLK1005S4N7ST	4.4	4.4	4.5	4.6	4.7	17	22	33	35	38
MLK1005S5N6DT	5.3	5.2	5.4	5.5	5.7	17	22	33	34	38
MLK1005S6N8DT	6.4	6.4	6.6	6.7	7.0	17	22	32	33	36
MLK1005S8N2DT	7.7	7.7	8.1	8.3	8.6	19	23	34	36	38
MLK1005S10NJT	9.4	9.4	10.0	10.2	10.7	19	23	34	35	38
MLK1005S12NJT	11.3	11.3	12.1	12.4	13.0	19	23	34	35	37
MLK1005S15NJT	14.2	14.2	15.3	15.8	16.8	18	23	33	34	35
MLK1005S18NJT	17.0	17.1	18.6	19.2	20.6	18	23	32	33	34
MLK1005S22NJT	20.8	20.9	23.0	23.9	25.8	18	23	32	33	34
MLK1005S27NJT	25.6	25.9	29.8	31.5	35.7	18	23	30	30	28
MLK1005S33NJT	31.4	31.9	37.6	40.2		18	23	29	29	
MLK1005S39NJT	37.2	38.1	48.9			17	21	24		
MLK1005S47NJT	45.0	46.2	60.6			18	21	24		
MLK1005S56NJT	53.7	55.4	76.7			17	21	22		
MLK1005S68NJT	65.4	68.1	102.3			17	20	19		
MLK1005S82NJT	79.4	83.3	137.7			16	19	17		
MLK1005SR10JT	97.4	103.7	204.7			16	19	14		

- All specifications are subject to change without notice.

TYPICAL ELECTRICAL CHARACTERISTICS INDUCTANCE vs. FREQUENCY CHARACTERISTICS

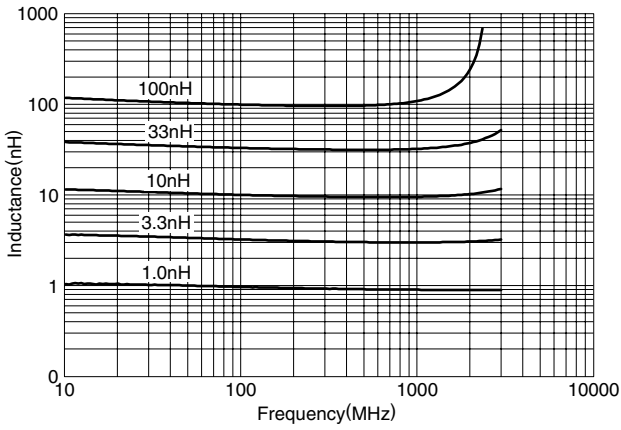

Q vs. FREQUENCY CHARACTERISTICS

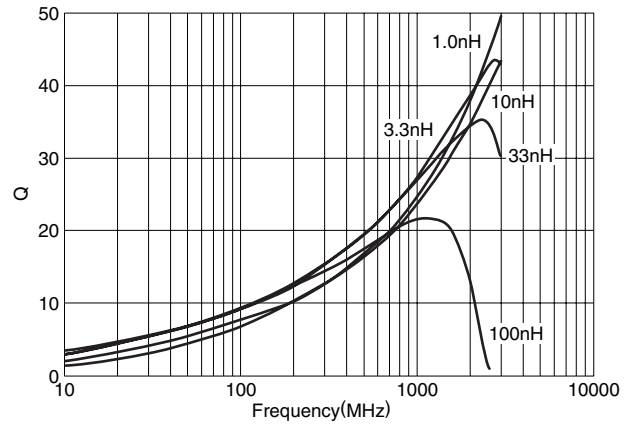

PACKAGING STYLES REEL DIMENSIONS

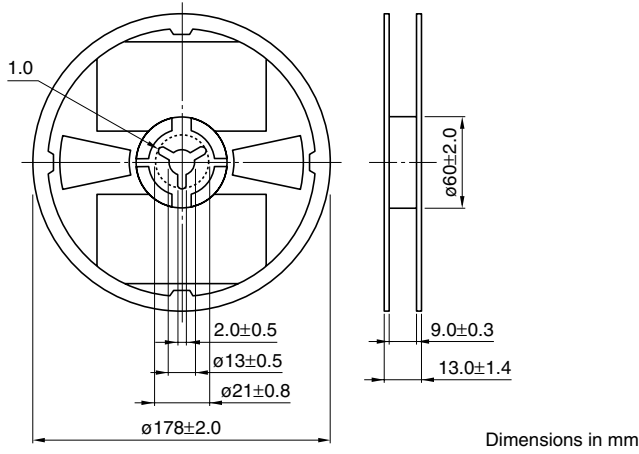

TAPE DIMENSIONS

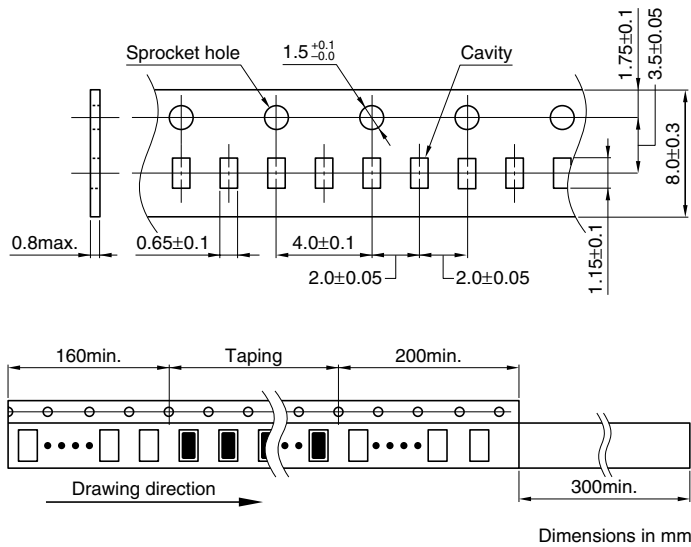

• All specifications are subject to change without notice.