

MOSFET - Power, N-Channel, UniFET™ II, Ultra FRFET™ 500 V, 2 A, 3 Ω

FDT4N50NZU

Description

UniFET II MOSFET is ON Semiconductor's high voltage MOSFET family based on advanced planar stripe and DMOS technology. This advanced MOSFET family has the smallest on-state resistance among the planar MOSFET, and also provides superior switching performance and higher avalanche energy strength. In addition, internal gate-source ESD diode allows UniFET II MOSFET to withstand over 2 kV HBM surge stress. UniFET II Ultra FRFET MOSFET has much superior body diode reverse recovery performance. Its t_{rr} is less than 50 nsec and the reverse dv/dt immunity is 20 V/nsec while normal planar MOSFETs have over 200 nsec and 4.5 V/nsec respectively. Therefore UniFET II Ultra FRFET MOSFET can remove additional component and improve system reliability in certain applications that require performance improvement of the MOSFET's body diode. This device family is suitable for switching power converter applications such as power factor correction (PFC), flat panel display (FPD) TV power, ATX and electronic lamp ballasts.

Features

- Typ. $R_{DS(on)} = 2.42 \Omega$
- Ultra Low Gate Charge (Typ. $Q_g = 9.1 \text{ nC}$)
- 100% Avalanche Tested
- These Devices are Pb-Free, Halogen Free/BFR Free and are RoHS Compliant

Applications

- Computing / Display Power Supplies
- Industrial Power Supplies
- Consumer Power Supplies



ON Semiconductor®

www.onsemi.com

V_{DSS}	$R_{DS(on)} \text{ MAX}$	$I_D \text{ MAX}$
500 V	3 Ω @ 10 V	2 A

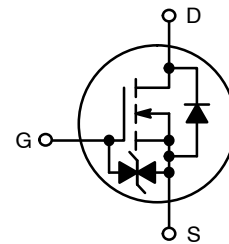

POWER MOSFET

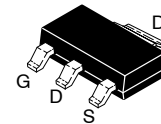

SOT-223
(TO-261)
CASE 318E

MARKING DIAGRAM

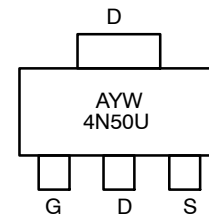

A = Assembly Location
Y = Year
W = Work Week
4N50U = Device Code

ORDERING INFORMATION

See detailed ordering and shipping information on page 2 of this data sheet.

FDT4N50NZU

ABSOLUTE MAXIMUM RATINGS (T_C = 25°C, Unless otherwise noted)

Symbol	Parameter	Value	Unit	
V _{DSS}	Drain to Source Voltage	500	V	
V _{GSS}	Gate to Source Voltage	- DC	±25	V
I _D	Drain Current	- Continuous (T _C = 25°C)	2	A
		- Continuous (T _C = 100°C)	1.2	
I _{DM}	Drain Current	- Pulsed (Note 1)	6	A
E _{AS}	Single Pulsed Avalanche Energy (Note 2)	46	mJ	
I _{AS}	Avalanche Current (Note 2)	2	A	
E _{AR}	Repetitive Avalanche Energy (Note 1)	2	mJ	
dv/dt	Peak Diode Recovery dv/dt (Note 3)	20	V/ns	
P _D	Power Dissipation	(T _C = 25°C)	2	W
		- Derate Above 25°C	0.02	W/°C
T _J , T _{STG}	Operating and Storage Temperature Range	-55 to +150	°C	
T _L	Maximum Lead Temperature for Soldering, 1/8" from Case for 5 seconds	300	°C	

Stresses exceeding those listed in the Maximum Ratings table may damage the device. If any of these limits are exceeded, device functionality should not be assumed, damage may occur and reliability may be affected.

NOTE: Drain current limited by maximum junction temperature.

1. Repetitive rating: pulse-width limited by maximum junction temperature.
2. I_{AS} = 2 A, R_G = 25 Ω, starting T_J = 25°C.
3. I_{SD} ≤ 3 A, di/dt ≤ 100 A/μs, V_{DD} ≤ 400 V, starting T_J = 25°C.

THERMAL CHARACTERISTICS

Symbol	Parameter	Value	Unit
R _{θJA}	Thermal Resistance, Junction to Ambient, (1 in ² Pad of 2 oz. Copper) Max.	60	°C/W

PACKAGE MARKING AND ORDERING INFORMATION

Part Number	Top Marking	Package	Packing Method	Reel Size	Tape Width	Quantity
FDT4N50NZU	FDT4N50NZU	SOT-223	Tape & Reel†	330 mm	12 mm	4000 Units

†For information on tape and reel specifications, including part orientation and tape sizes, please refer to our Tape and Reel Packaging Specifications Brochure, BRD8011/D.

FDT4N50NZU

ELECTRICAL CHARACTERISTICS ($T_C = 25^\circ\text{C}$ unless otherwise noted)

Symbol	Parameter	Test Conditions	Min.	Typ.	Max.	Unit
--------	-----------	-----------------	------	------	------	------

OFF CHARACTERISTICS

BV_{DSS}	Drain to Source Breakdown Voltage	$V_{GS} = 0\text{ V}, I_D = 250\ \mu\text{A}, T_J = 25^\circ\text{C}$	500			V
$\Delta BV_{DSS} / \Delta T_J$	Breakdown Voltage Temperature Coefficient	$I_D = 1\ \text{mA}$, Referenced to 25°C		0.55		V/ $^\circ\text{C}$
I_{DSS}	Zero Gate Voltage Drain Current	$V_{DS} = 500\ \text{V}, V_{GS} = 0\ \text{V}$			1	μA
		$V_{DS} = 400\ \text{V}, T_C = 125^\circ\text{C}$		4.6		
I_{GSS}	Gate to Body Leakage Current	$V_{GS} = \pm 25\ \text{V}, V_{DS} = 0\ \text{V}$			± 10	μA

ON CHARACTERISTICS

$V_{GS(th)}$	Gate Threshold Voltage	$V_{GS} = V_{DS}, I_D = 250\ \mu\text{A}$	3.5		5.5	V
$R_{DS(on)}$	Static Drain to Source On Resistance	$V_{GS} = 10\ \text{V}, I_D = 1\ \text{A}$		2.42	3	Ω
g_{FS}	Forward Transconductance	$V_{DS} = 20\ \text{V}, I_D = 1\ \text{A}$		1		S

DYNAMIC CHARACTERISTICS

C_{iss}	Input Capacitance	$V_{DS} = 25\ \text{V}, V_{GS} = 0\ \text{V}, f = 1\ \text{MHz}$		476		pF
C_{oss}	Output Capacitance			43		pF
C_{rss}	Reverse Transfer Capacitance			2.7		pF
$Q_{g(tot)}$	Total Gate Charge at 10 V	$V_{DS} = 400\ \text{V}, I_D = 3\ \text{A}, V_{GS} = 10\ \text{V}$ (Note 4)		9.1		nC
Q_{gs}	Gate to Source Gate Charge			2.9		nC
Q_{gd}	Gate to Drain "Miller" Charge			3.3		nC

SWITCHING CHARACTERISTICS

$t_{d(on)}$	Turn-On Delay Time	$V_{DD} = 250\ \text{V}, I_D = 3\ \text{A}, V_{GS} = 10\ \text{V},$ $R_g = 25\ \Omega$ (Note 4)		16		ns
t_r	Turn-On Rise Time			16		ns
$t_{d(off)}$	Turn-Off Delay Time			34		ns
t_f	Turn-Off Fall Time			15		ns

SOURCE-DRAIN DIODE CHARACTERISTICS

I_S	Maximum Continuous Source to Drain Diode Forward Current			2		A
I_{SM}	Maximum Pulsed Source to Drain Diode Forward Current			6		A
V_{SD}	Source to Drain Diode Forward Voltage	$V_{GS} = 0\ \text{V}, I_{SD} = 1\ \text{A}$			1.2	V
t_{rr}	Reverse Recovery Time	$V_{DD} = 400\ \text{V}, I_{SD} = 3\ \text{A}, dI_F/dt = 100\ \text{A}/\mu\text{s}$		24		ns
Q_{rr}	Reverse Recovery Charge			18		nC

Product parametric performance is indicated in the Electrical Characteristics for the listed test conditions, unless otherwise noted. Product performance may not be indicated by the Electrical Characteristics if operated under different conditions.

4. Essentially independent of operating temperature typical characteristics.

FDT4N50NZU

TYPICAL CHARACTERISTICS

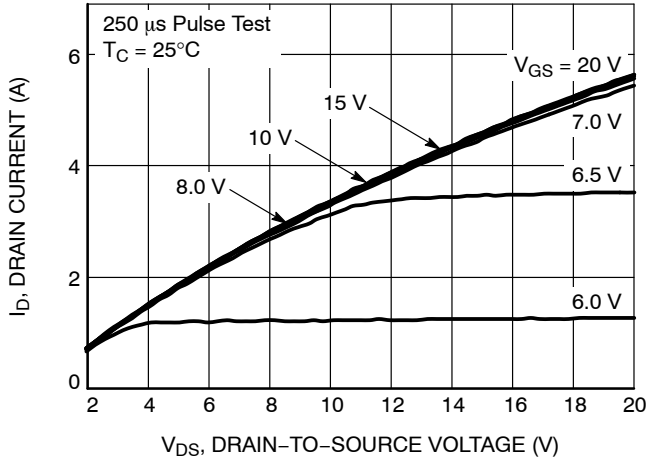

Figure 1. On-Region Characteristics

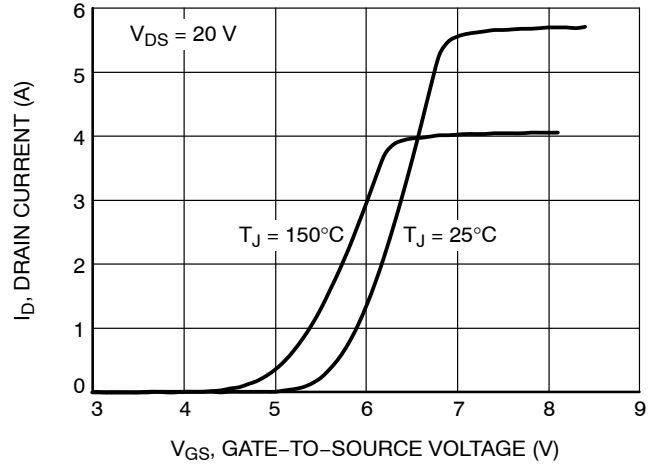

Figure 2. Transfer Characteristics

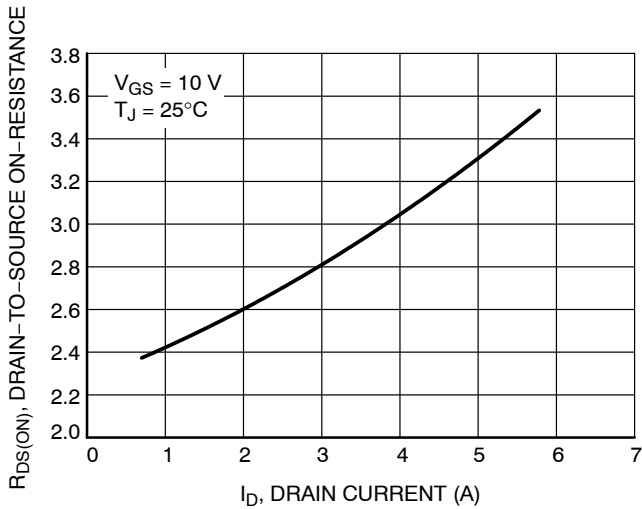

Figure 3. On-Resistance Variation vs. Drain Current and Gate Voltage

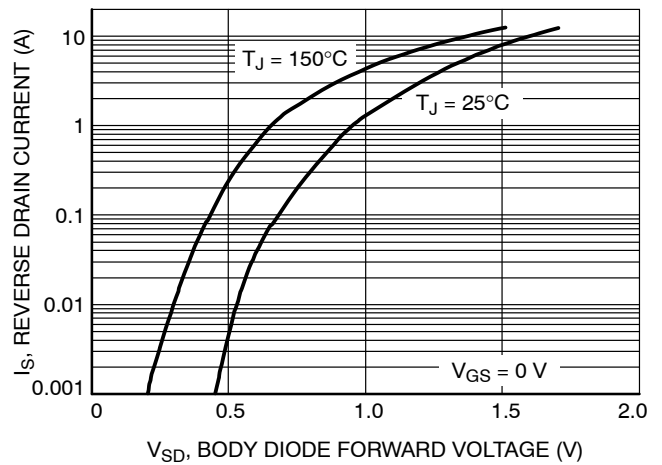

Figure 4. Body Diode Forward Voltage Variation vs. Source Current and Temperature

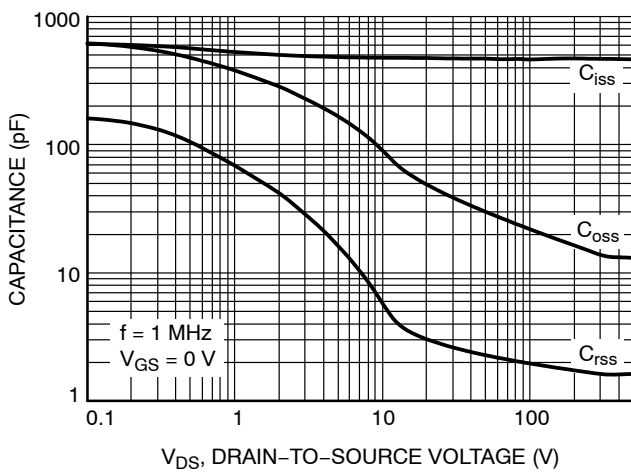

Figure 5. Capacitance Characteristics

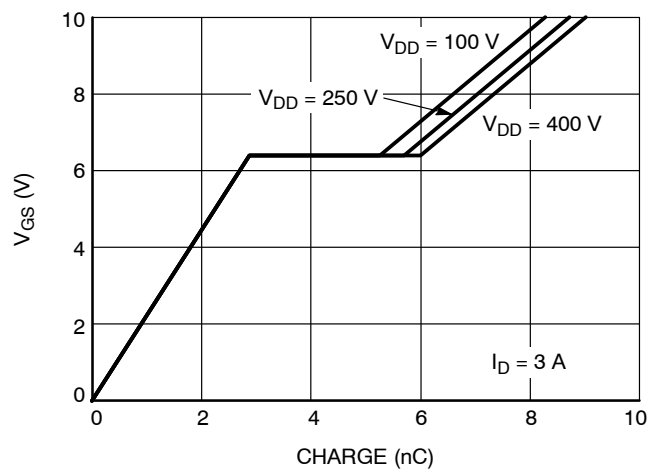

Figure 6. Gate Charge Characteristics

FDT4N50NZU

TYPICAL CHARACTERISTICS

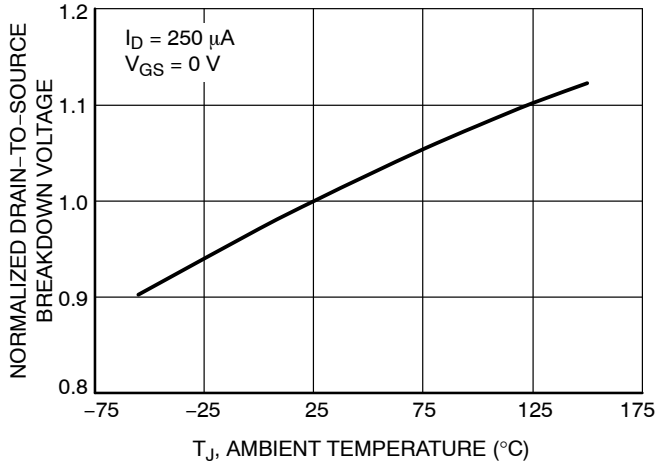

Figure 7. Breakdown Voltage Variation vs. Temperature

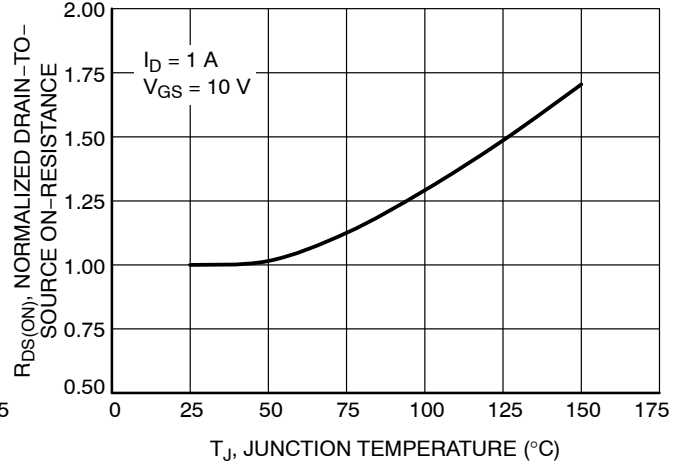

Figure 8. On-Resistance Variation vs. Temperature

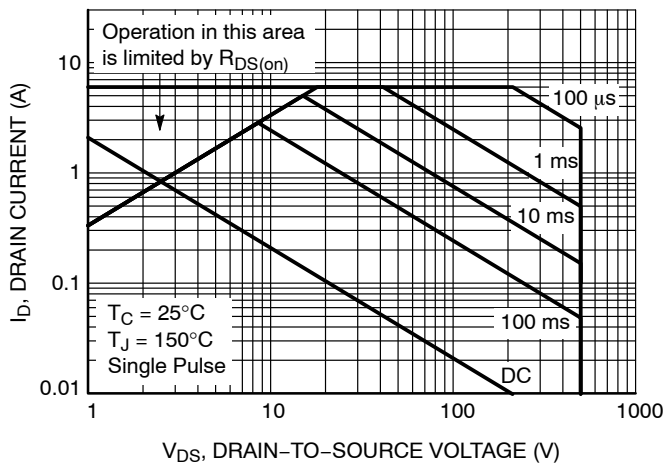

Figure 9. Maximum Safe Operating Area

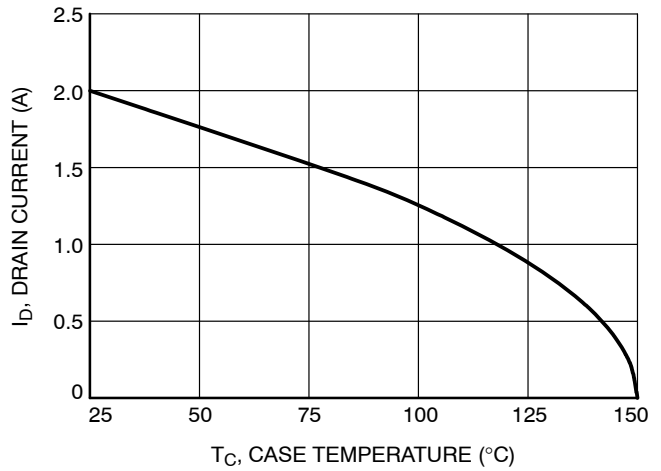

Figure 10. Maximum Drain Current vs. Case Temperature

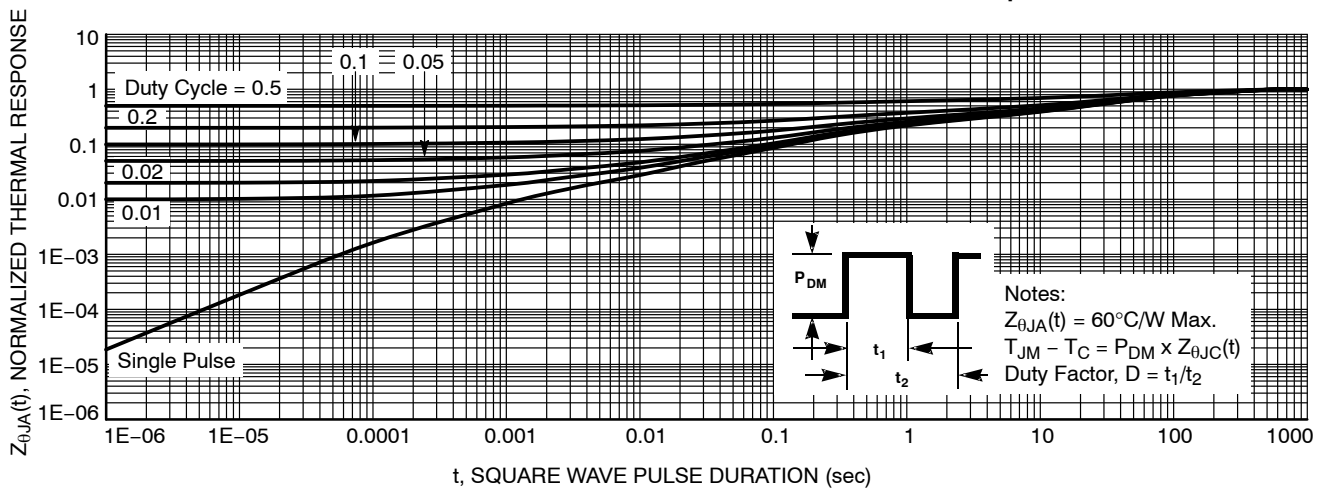

Figure 11. Transient Thermal Response

FDT4N50NZU

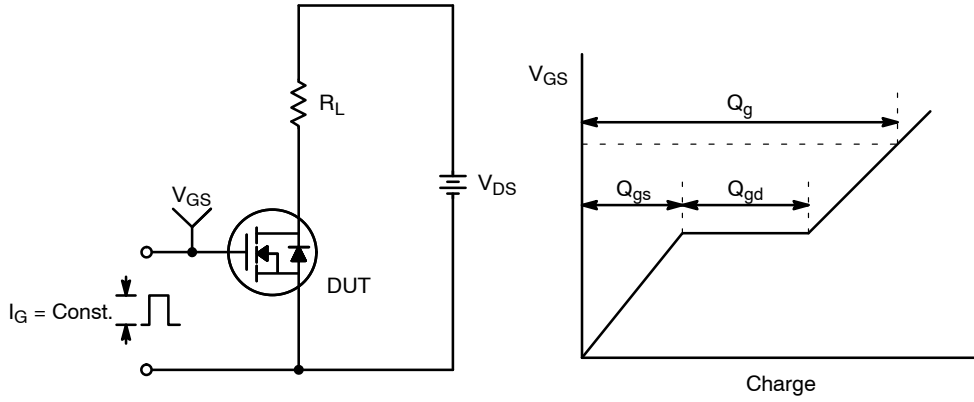

Figure 12. Gate Charge Test Circuit & Waveform

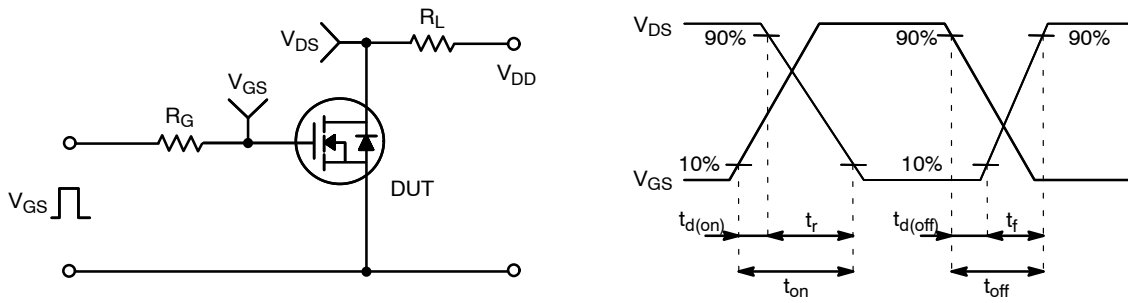

Figure 13. Resistive Switching Test Circuit & Waveforms

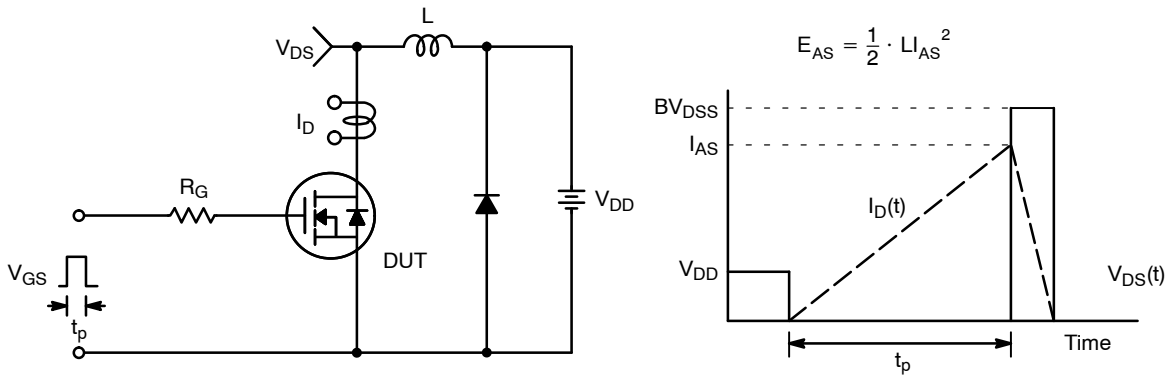

Figure 14. Unclamped Inductive Switching Test Circuit & Waveforms

FDT4N50NZU

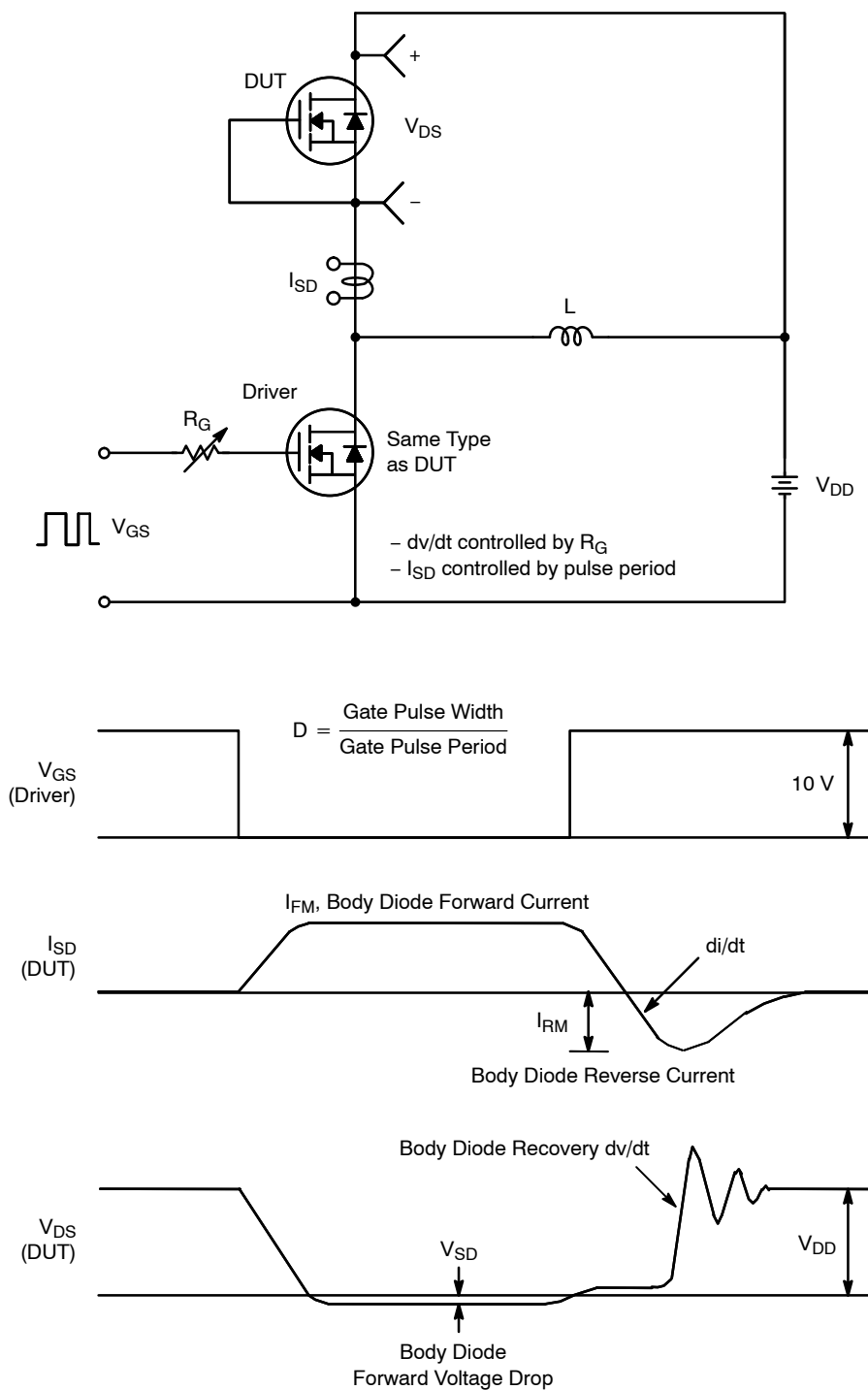
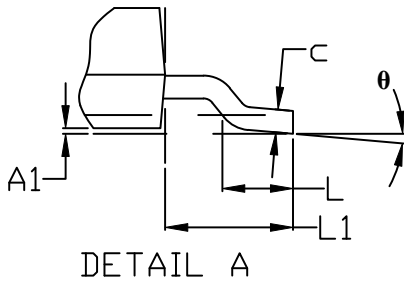
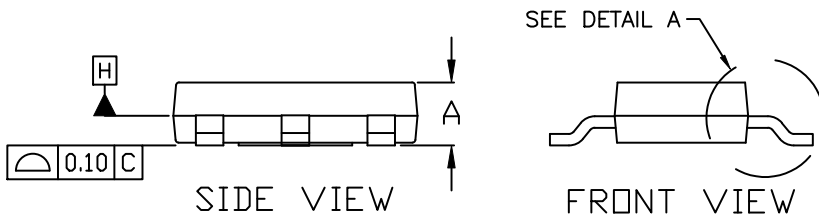
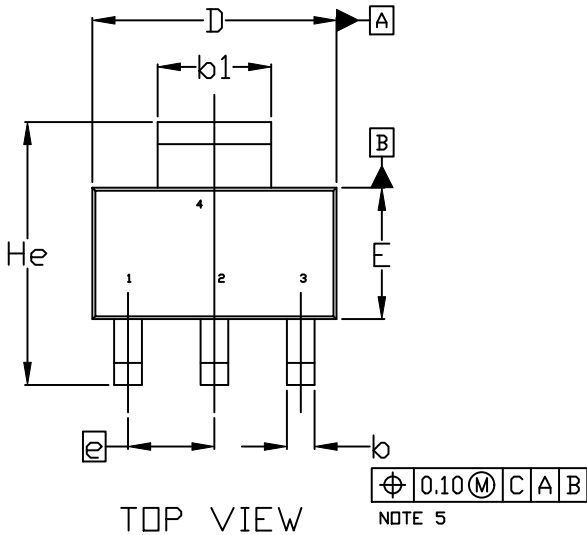

Figure 15. Peak Diode Recovery dv/dt Test Circuit & Waveforms

FDT4N50NZU

PACKAGE DIMENSIONS

SOT-223 (TO-261)
CASE 318E-04
ISSUE R



NOTES:

1. DIMENSIONING AND TOLERANCING PER ASME Y14.5M, 1994.
2. CONTROLLING DIMENSION: MILLIMETERS
3. DIMENSIONS D & E DO NOT INCLUDE MOLD FLASH, PROTRUSIONS OR GATE BURRS. MOLD FLASH, PROTRUSIONS OR GATE BURRS SHALL NOT EXCEED 0.200MM PER SIDE.
4. DATUMS A AND B ARE DETERMINED AT DATUM H.
5. A1 IS DEFINED AS THE VERTICAL DISTANCE FROM THE SEATING PLANE TO THE LOWEST POINT OF THE PACKAGE BODY.
6. POSITIONAL TOLERANCE APPLIES TO DIMENSIONS b AND b1.

DIM	MILLIMETERS		
	MIN.	NOM.	MAX.
A	1.50	1.63	1.75
A1	0.02	0.06	0.10
b	0.60	0.75	0.89
b1	2.90	3.06	3.20
c	0.24	0.29	0.35
D	6.30	6.50	6.70
E	3.30	3.50	3.70
e	2.30 BSC		
L	0.20	---	---
L1	1.50	1.75	2.00
He	6.70	7.00	7.30
θ	0°	---	10°

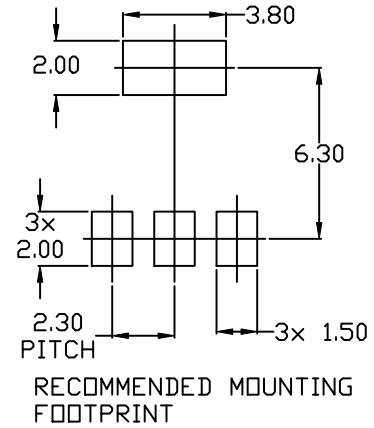

ON Semiconductor and  are trademarks of Semiconductor Components Industries, LLC dba ON Semiconductor or its subsidiaries in the United States and/or other countries. ON Semiconductor owns the rights to a number of patents, trademarks, copyrights, trade secrets, and other intellectual property. A listing of ON Semiconductor's product/patent coverage may be accessed at www.onsemi.com/site/pdf/Patent-Marking.pdf. ON Semiconductor reserves the right to make changes without further notice to any products herein. ON Semiconductor makes no warranty, representation or guarantee regarding the suitability of its products for any particular purpose, nor does ON Semiconductor assume any liability arising out of the application or use of any product or circuit, and specifically disclaims any and all liability, including without limitation special, consequential or incidental damages. Buyer is responsible for its products and applications using ON Semiconductor products, including compliance with all laws, regulations and safety requirements or standards, regardless of any support or applications information provided by ON Semiconductor. "Typical" parameters which may be provided in ON Semiconductor data sheets and/or specifications can and do vary in different applications and actual performance may vary over time. All operating parameters, including "Typicals" must be validated for each customer application by customer's technical experts. ON Semiconductor does not convey any license under its patent rights nor the rights of others. ON Semiconductor products are not designed, intended, or authorized for use as a critical component in life support systems or any FDA Class 3 medical devices or medical devices with a same or similar classification in a foreign jurisdiction or any devices intended for implantation in the human body. Should Buyer purchase or use ON Semiconductor products for any such unintended or unauthorized application, Buyer shall indemnify and hold ON Semiconductor and its officers, employees, subsidiaries, affiliates, and distributors harmless against all claims, costs, damages, and expenses, and reasonable attorney fees arising out of, directly or indirectly, any claim of personal injury or death associated with such unintended or unauthorized use, even if such claim alleges that ON Semiconductor was negligent regarding the design or manufacture of the part. ON Semiconductor is an Equal Opportunity/Affirmative Action Employer. This literature is subject to all applicable copyright laws and is not for resale in any manner.

PUBLICATION ORDERING INFORMATION

LITERATURE FULFILLMENT:

Email Requests to: orderlit@onsemi.com

ON Semiconductor Website: www.onsemi.com

TECHNICAL SUPPORT

North American Technical Support:
Voice Mail: 1 800-282-9855 Toll Free USA/Canada
Phone: 011 421 33 790 2910

Europe, Middle East and Africa Technical Support:
Phone: 00421 33 790 2910

For additional information, please contact your local Sales Representative