

MOSFET - Power, Single N-Channel

120 V, 8.0 mΩ, 79 A

NTMFS008N12MC

Features

- Small Footprint (5x6 mm) for Compact Design
- Low $R_{DS(on)}$ to Minimize Conduction Losses
- Low Q_G and Capacitance to Minimize Driver Losses
- Soft Body Diode Reduces Voltage Ringing
- These Devices are Pb-Free, Halogen-Free / BFR Free and are RoHS Compliant

Typical Applications

- Synchronous Rectification
- AC-DC and DC-DC Power Supplies
- AC-DC Adapters (USB PD) SR
- Load Switch

MAXIMUM RATINGS ($T_J = 25^\circ\text{C}$ unless otherwise noted)

Parameter		Symbol	Value	Unit	
Drain-to-Source Voltage		V_{DSS}	120	V	
Gate-to-Source Voltage		V_{GS}	± 20	V	
Continuous Drain Current $R_{\theta JC}$ (Notes 1, 3)	Steady State	$T_C = 25^\circ\text{C}$	I_D	79	A
		$T_C = 100^\circ\text{C}$	I_D	50	
Power Dissipation $R_{\theta JC}$ (Note 1)	Steady State	$T_C = 25^\circ\text{C}$	P_D	102	W
		$T_C = 100^\circ\text{C}$	P_D	40	
Continuous Drain Current $R_{\theta JA}$ (Notes 1, 2, 3)	Steady State	$T_A = 25^\circ\text{C}$	I_D	12	A
		$T_A = 100^\circ\text{C}$	I_D	8	
Power Dissipation $R_{\theta JA}$ (Notes 1, 2)	Steady State	$T_A = 25^\circ\text{C}$	P_D	2.7	W
		$T_A = 100^\circ\text{C}$	P_D	1.1	
Pulsed Drain Current	$T_A = 25^\circ\text{C}, t_p = 100 \mu\text{s}$	I_{DM}	352	A	
Operating Junction and Storage Temperature Range		T_J, T_{stg}	-55 to +150	$^\circ\text{C}$	
Source Current (Body Diode)		I_S	85	A	
Single Pulse Drain-to-Source Avalanche Energy ($I_{AV} = 45 \text{ A}, L = 0.1 \text{ mH}$)		E_{AS}	101	mJ	
Lead Temperature Soldering Reflow for Soldering Purposes (1/8" from case for 10 s)		T_L	260	$^\circ\text{C}$	

Stresses exceeding those listed in the Maximum Ratings table may damage the device. If any of these limits are exceeded, device functionality should not be assumed, damage may occur and reliability may be affected.

THERMAL RESISTANCE MAXIMUM RATINGS

Parameter	Symbol	Value	Unit
Junction-to-Case - Steady State	$R_{\theta JC}$	1.22	$^\circ\text{C/W}$
Junction-to-Ambient - Steady State (Note 2)	$R_{\theta JA}$	45	

1. The entire application environment impacts the thermal resistance values shown, they are not constants and are only valid for the particular conditions noted.
2. Surface-mounted on FR4 board using a 650 mm², 2 oz. Cu pad.
3. Maximum current for pulses as long as 1 second is higher but is dependent on pulse duration and duty cycle.



ON Semiconductor®

www.onsemi.com

$V_{(BR)DSS}$	$R_{DS(ON)} \text{ MAX}$	$I_D \text{ MAX}$
120 V	8.0 mΩ @ 10 V	79 A
	20 mΩ @ 6 V	

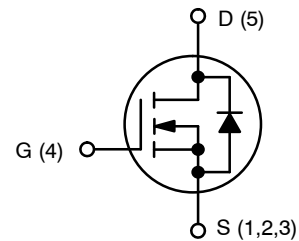

N-CHANNEL MOSFET

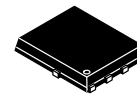

SO-8
FLAT LEAD
CASE 488AA

MARKING DIAGRAM

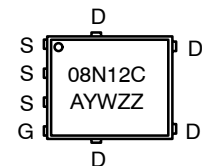

08N12C = Specific Device Code
 A = Assembly Location
 Y = Year
 W = Work Week
 ZZ = Lot Traceability

ORDERING INFORMATION

See detailed ordering, marking and shipping information on page 5 of this data sheet.

NTMFS008N12MC

ELECTRICAL CHARACTERISTICS (T_J = 25°C unless otherwise specified)

Parameter	Symbol	Test Condition	Min	Typ	Max	Unit
-----------	--------	----------------	-----	-----	-----	------

OFF CHARACTERISTICS

Drain-to-Source Breakdown Voltage	V _{(BR)DSS}	V _{GS} = 0 V, I _D = 250 μA	120			V
Drain-to-Source Breakdown Voltage Temperature Coefficient	V _{(BR)DSS} /T _J	I _D = 250 μA, ref to 25°C		30		mV/°C
Zero Gate Voltage Drain Current	I _{DSS}	V _{GS} = 0 V, V _{DS} = 120 V	T _J = 25°C		1	μA
			T _J = 125°C		100	
Gate-to-Source Leakage Current	I _{GSS}	V _{DS} = 0 V, V _{GS} = ±20 V			±100	nA

ON CHARACTERISTICS (Note 4)

Gate Threshold Voltage	V _{GS(TH)}	V _{GS} = V _{DS} , I _D = 200 μA	2.0		4.0	V
Negative Threshold Temperature Coefficient	V _{GS(TH)} /T _J	I _D = 200 μA, ref to 25°C		-10		mV/°C
Drain-to-Source On Resistance	R _{DS(on)}	V _{GS} = 10 V, I _D = 36 A		6.5	8.0	mΩ
		V _{GS} = 6 V, I _D = 18 A		11.5	20	
Forward Transconductance	g _{FS}	V _{DS} = 15 V, I _D = 36 A		111		S

CHARGES & CAPACITANCES

Input Capacitance	C _{ISS}	V _{GS} = 0 V, f = 1 MHz, V _{DS} = 60 V		2705		pF
Output Capacitance	C _{OSS}			1150		
Reverse Transfer Capacitance	C _{RSS}			4.9		
Total Gate Charge	Q _{G(TOT)}	V _{GS} = 10 V, V _{DS} = 60 V, I _D = 36 A		33		nC
Gate-to-Source Charge	Q _{GS}			14		
Gate-to-Drain Charge	Q _{GD}			6.0		
Threshold Gate Charge	Q _{G(TH)}			8.0		
Plateau Voltage	V _{GP}			5.5		
Output Charge	Q _{OSS}	V _{GS} = 0 V, f = 1 MHz, V _{DS} = 60 V		98		nC

SWITCHING CHARACTERISTICS (Note 4)

Turn-On Delay Time	t _{d(ON)}	V _{GS} = 10 V, V _{DS} = 60 V, I _D = 36 A, R _G = 2.5 Ω		18.4		ns
Rise Time	t _r			4.0		
Turn-Off Delay Time	t _{d(OFF)}			22.8		
Fall Time	t _f			4.6		

DRAIN-SOURCE DIODE CHARACTERISTICS

Forward Diode Voltage	V _{SD}	V _{GS} = 0 V, I _S = 36 A	T _J = 25°C		0.9	1.2	V
			T _J = 125°C		0.8		
Reverse Recovery Time	t _{RR}	V _{GS} = 0 V, dI _S /dt = 300 A/μs, I _S = 36 A		50		ns	
Charge Time	T _a			25		ns	
Discharge Time	T _b			26		ns	
Reverse Recovery Charge	Q _{RR}			165		nC	
Reverse Recovery Time	t _{RR}	V _{GS} = 0 V, dI _S /dt = 1000 A/μs, I _S = 36 A		34		ns	
Charge Time	T _a			26		ns	
Discharge Time	T _b			8		ns	
Reverse Recovery Charge	Q _{RR}				372		nC

Product parametric performance is indicated in the Electrical Characteristics for the listed test conditions, unless otherwise noted. Product performance may not be indicated by the Electrical Characteristics if operated under different conditions.

4. Pulse Test: pulse width ≤ 300 μs, duty cycle ≤ 2%.

5. Switching characteristics are independent of operating junction temperatures.

TYPICAL CHARACTERISTICS

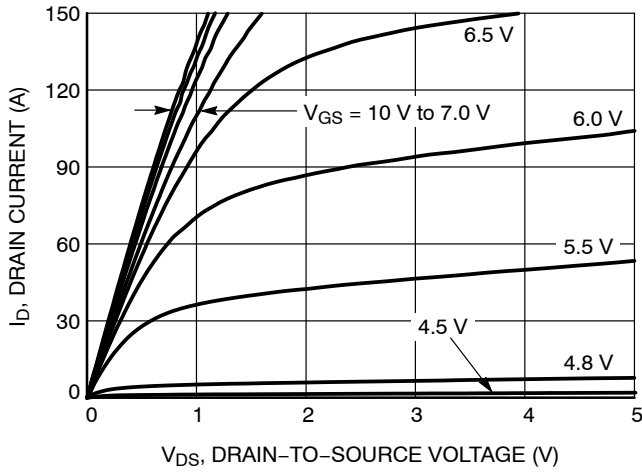

Figure 1. On-Region Characteristics

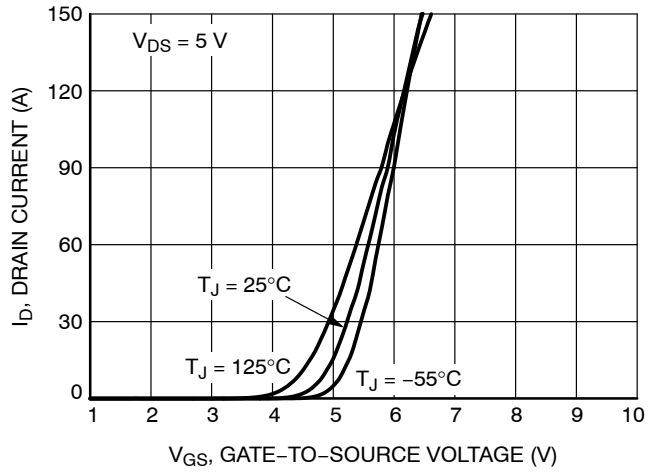

Figure 2. Transfer Characteristics

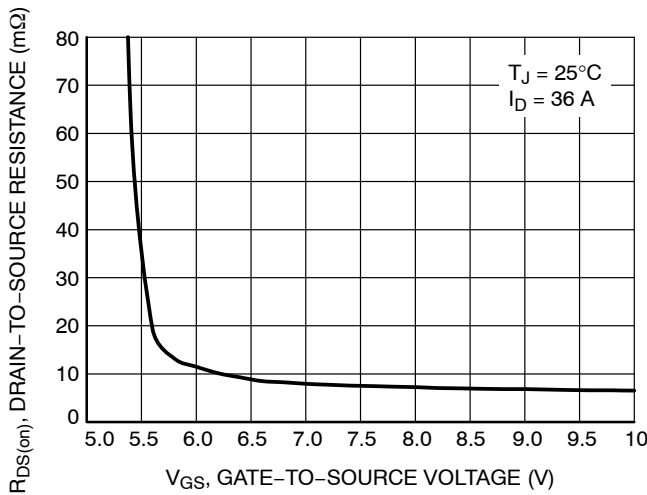

Figure 3. On-Resistance vs. Gate-to-Source Voltage

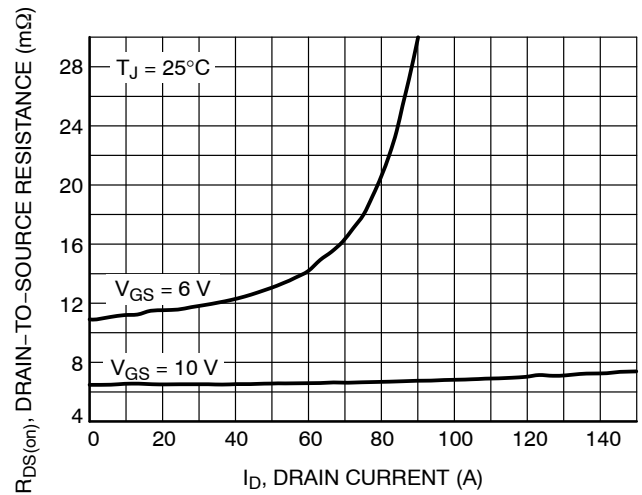

Figure 4. On-Resistance vs. Drain Current and Gate Voltage

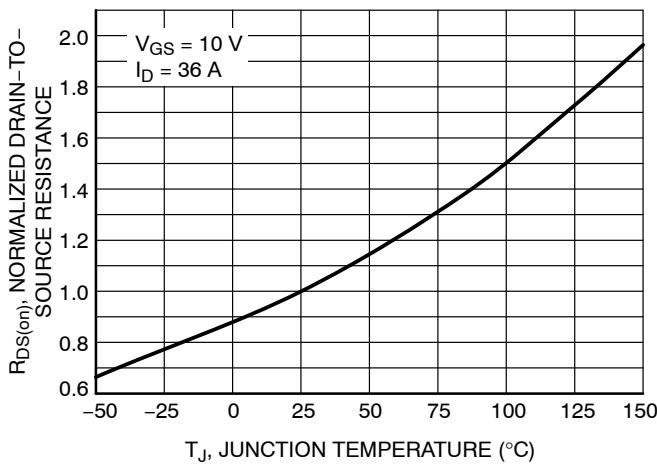

Figure 5. On-Resistance Variation with Temperature

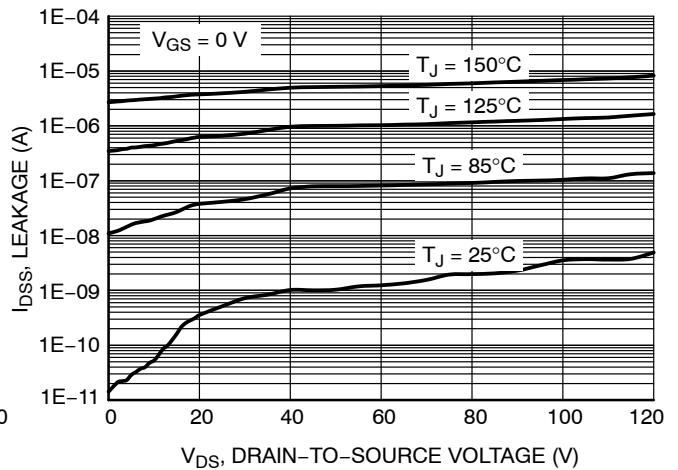

Figure 6. Drain-to-Source Leakage Current vs. Voltage

NTMFS008N12MC

TYPICAL CHARACTERISTICS

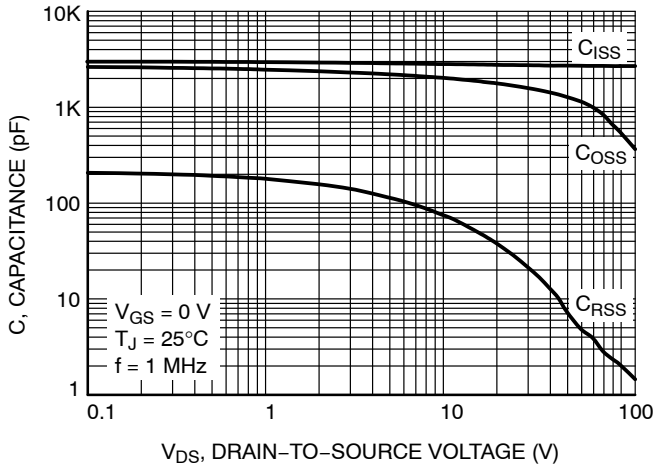

Figure 7. Capacitance Variation

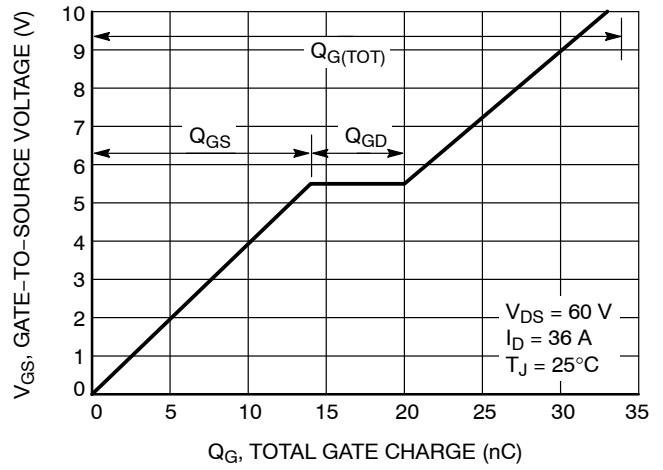

Figure 8. Gate-to-Source and Drain-to-Source Voltage vs. Total Charge

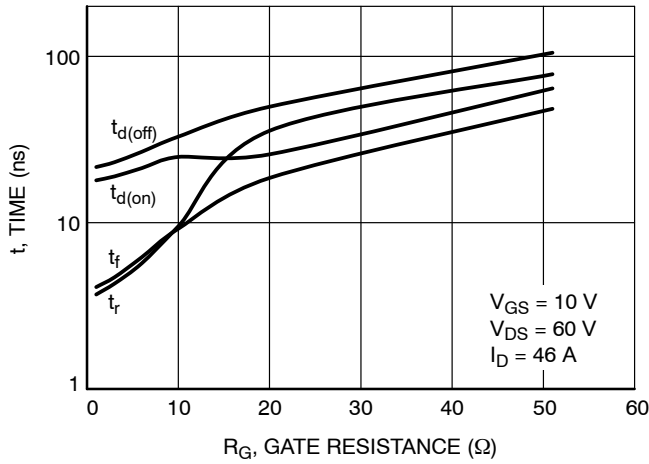

Figure 9. Resistive Switching Time Variation vs. Gate Resistance

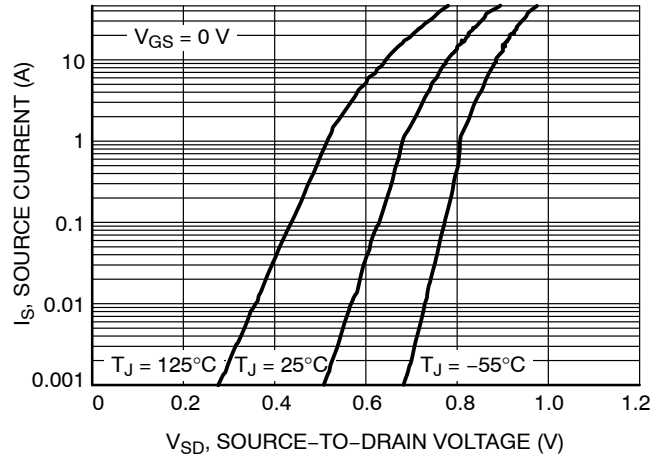

Figure 10. Diode Forward Voltage vs. Current

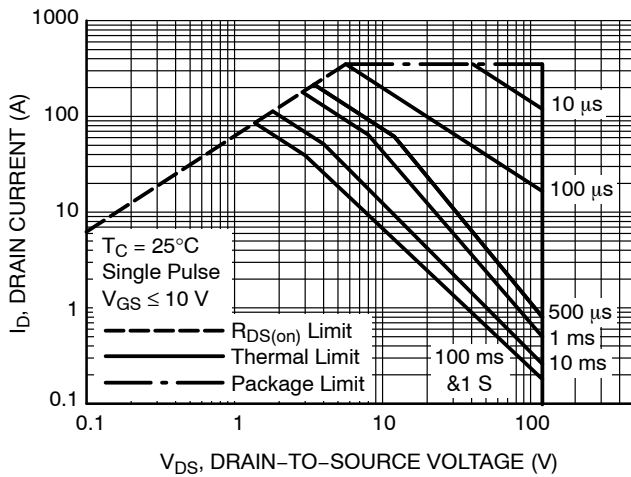

Figure 11. Safe Operating Area

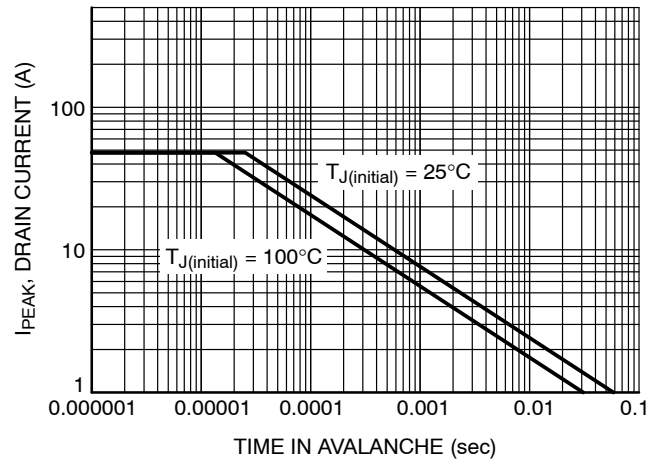

Figure 12. I_{PEAK} vs. Time in Avalanche

NTMFS008N12MC

TYPICAL CHARACTERISTICS

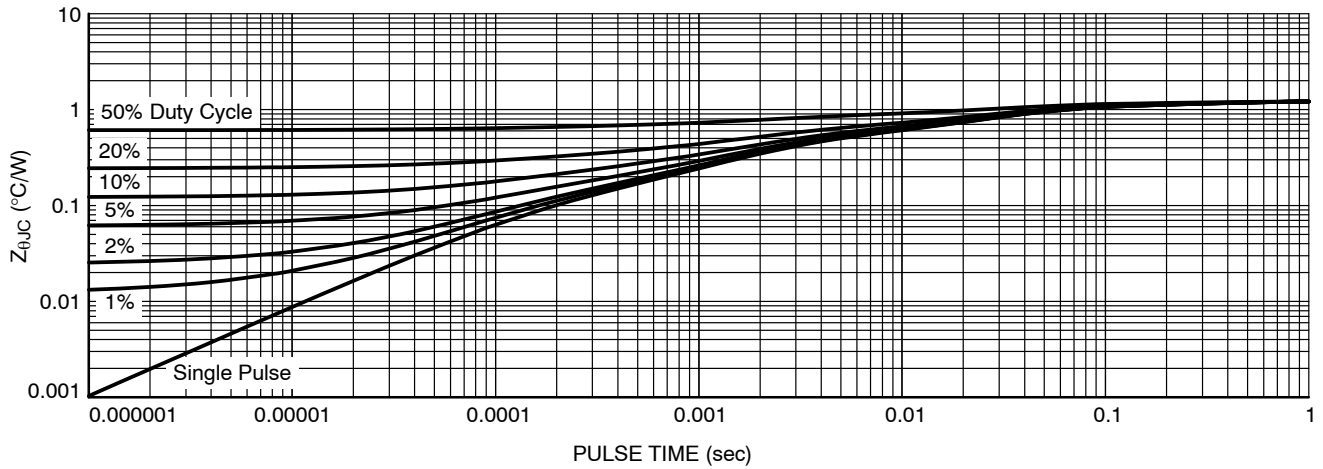

Figure 13. Thermal Characteristics

DEVICE ORDERING INFORMATION

Device	Marking	Package	Shipping [†]
NTMFS008N12MCT1G	08N12C	DFN5 (Pb-Free)	1500 / Tape & Reel

[†]For information on tape and reel specifications, including part orientation and tape sizes, please refer to our Tape and Reel Packaging Specifications Brochure, BRD8011/D.

NTMFS008N12MC

PACKAGE DIMENSIONS

DFN5 5x6, 1.27P
(SO-8FL)
CASE 488AA
ISSUE N

NOTES:

1. DIMENSIONING AND TOLERANCING PER ASME Y14.5M, 1994.
2. CONTROLLING DIMENSION: MILLIMETER.
3. DIMENSION D1 AND E1 DO NOT INCLUDE MOLD FLASH PROTRUSIONS OR GATE BURRS.

DIM	MILLIMETERS		
	MIN	NOM	MAX
A	0.90	1.00	1.10
A1	0.00	---	0.05
b	0.33	0.41	0.51
c	0.23	0.28	0.33
D	5.00	5.15	5.30
D1	4.70	4.90	5.10
D2	3.80	4.00	4.20
E	6.00	6.15	6.30
E1	5.70	5.90	6.10
E2	3.45	3.65	3.85
e	1.27 BSC		
G	0.51	0.575	0.71
K	1.20	1.35	1.50
L	0.51	0.575	0.71
L1	0.125 REF		
M	3.00	3.40	3.80
θ	0°	---	12°

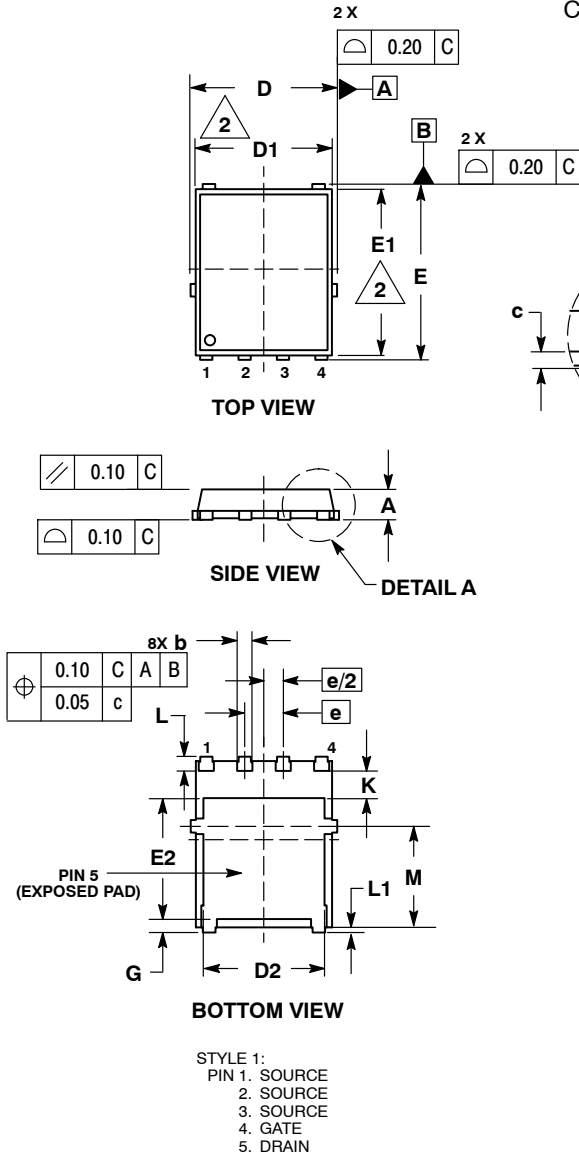

RECOMMENDED SOLDERING FOOTPRINT*

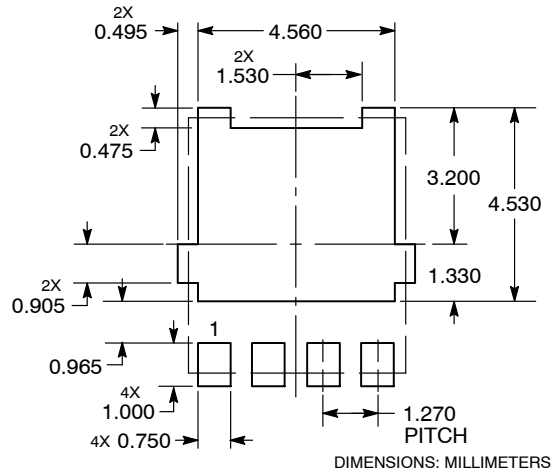

*For additional information on our Pb-Free strategy and soldering details, please download the ON Semiconductor Soldering and Mounting Techniques Reference Manual, SOLDERRM/D.

ON Semiconductor and are trademarks of Semiconductor Components Industries, LLC dba ON Semiconductor or its subsidiaries in the United States and/or other countries. ON Semiconductor owns the rights to a number of patents, trademarks, copyrights, trade secrets, and other intellectual property. A listing of ON Semiconductor's product/patent coverage may be accessed at www.onsemi.com/site/pdf/Patent-Marking.pdf. ON Semiconductor reserves the right to make changes without further notice to any products herein. ON Semiconductor makes no warranty, representation or guarantee regarding the suitability of its products for any particular purpose, nor does ON Semiconductor assume any liability arising out of the application or use of any product or circuit, and specifically disclaims any and all liability, including without limitation special, consequential or incidental damages. Buyer is responsible for its products and applications using ON Semiconductor products, including compliance with all laws, regulations and safety requirements or standards, regardless of any support or applications information provided by ON Semiconductor. "Typical" parameters which may be provided in ON Semiconductor data sheets and/or specifications can and do vary in different applications and actual performance may vary over time. All operating parameters, including "Typicals" must be validated for each customer application by customer's technical experts. ON Semiconductor does not convey any license under its patent rights nor the rights of others. ON Semiconductor products are not designed, intended, or authorized for use as a critical component in life support systems or any FDA Class 3 medical devices or medical devices with a same or similar classification in a foreign jurisdiction or any devices intended for implantation in the human body. Should Buyer purchase or use ON Semiconductor products for any such unintended or unauthorized application, Buyer shall indemnify and hold ON Semiconductor and its officers, employees, subsidiaries, affiliates, and distributors harmless against all claims, costs, damages, and expenses, and reasonable attorney fees arising out of, directly or indirectly, any claim of personal injury or death associated with such unintended or unauthorized use, even if such claim alleges that ON Semiconductor was negligent regarding the design or manufacture of the part. ON Semiconductor is an Equal Opportunity/Affirmative Action Employer. This literature is subject to all applicable copyright laws and is not for resale in any manner.

PUBLICATION ORDERING INFORMATION

LITERATURE FULFILLMENT:
Email Requests to: orderlit@onsemi.com

TECHNICAL SUPPORT
North American Technical Support:
Voice Mail: 1 800-282-9855 Toll Free USA/Canada
Phone: 011 421 33 790 2910

Europe, Middle East and Africa Technical Support:
Phone: 00421 33 790 2910
For additional information, please contact your local Sales Representative