

XCL230B0K1H2 Evaluation Board User Manual

36V, 600mA Inductor Built-in Step-down “micro DC/DC” Converter

CAUTION

ENGINEERING EVALUATION PURPOSES ONLY

This evaluation board is made for the purpose of the product evaluation. It is strictly prohibited to use this evaluation board for any other purpose.

Torex Semiconductor does not guarantee that all samples will perform in exactly the same way and we recommend that you always consult our product data sheets for the minimum and maximum specifications.

It is also important that you evaluate all our products carefully before mass

XCL230B0K1H2 Evaluation Board

36V, 600mA Inductor Built-in Step-down "micro DC/DC" Converter

Evaluation Board Picture

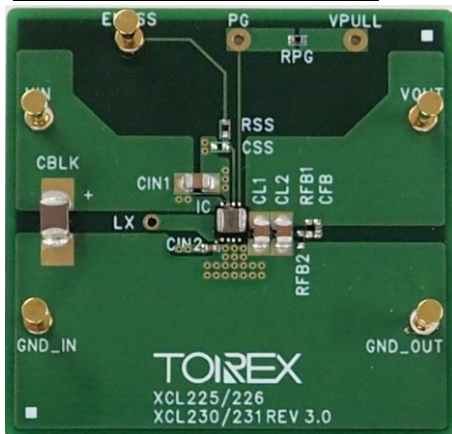

Evaluation Board SPEC

						Ta=25°C
		CONDITON.	MIN.	TYP.	MAX.	UNIT
Vin	Input Voltage Range	-	3.0	-	36.0	V
Vout	Setting Output Voltage	-	-	5.0	-	V
Iout	Output Current	-	0.0	-	600.0	mA
fosc	Switching frequency	-	-	1.2	-	MHz

XCL230/XCL231 Series Features

- Input Voltage Range 3.6V ~ 36.0V
- Output Voltage Range 1.0V ~ 5.0V
- Max Output Current 600mA max.
- Switching frequency 1.2MHz
- Max Duty Cycle 100%
- Small Solution Size

- Low EMI Noise
- Built-in Inductor
- Sequence Control is possible. (Power Good and Soft Start functions)

XCL230B0K1H2 Evaluation Board

36V, 600mA Inductor Built-in Step-down "micro DC/DC" Converter

Quick Start Procedure

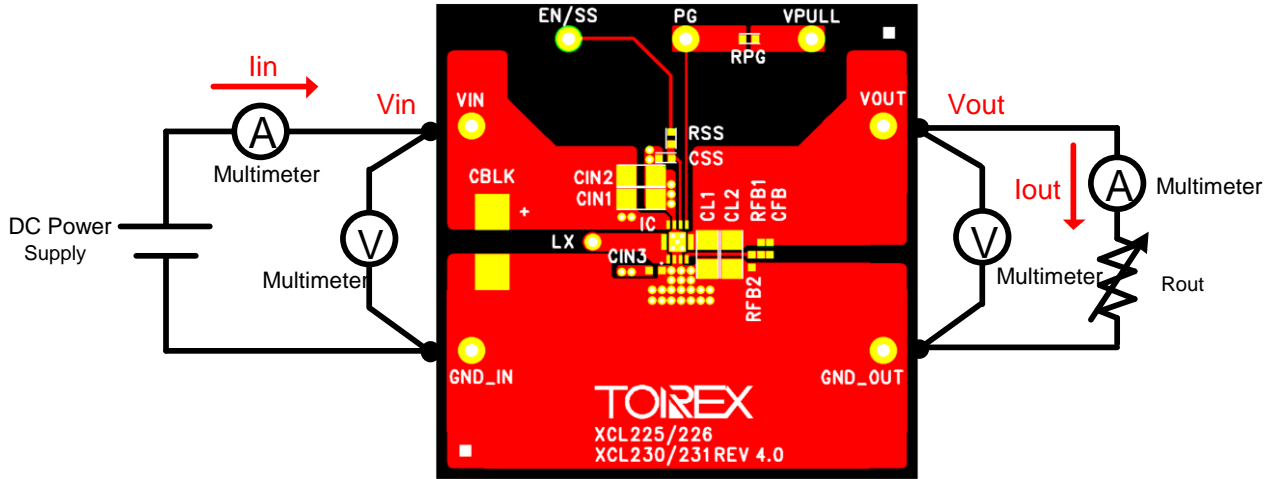

XCL230B0K1H2 Evaluation Board

36V, 600mA Inductor Built-in Step-down "micro DC/DC" Converter

Schematic

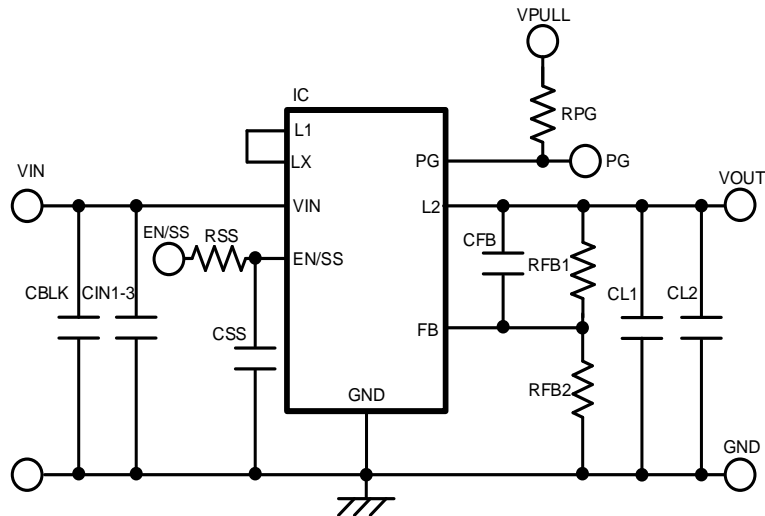

BOM

Required Circuit Component

Item	Value	Description	Size [mm]	Part Number	Manufacture
IC	-	Step-Down micro DC/DC Converters	DFN3030-10B	XCL230B0K1H2	TOREX
CIN1	4.7uF	Ceramic cap., 50V	2012	C2012X7R1H475K125AC	TDK
CIN2	4.7uF	Ceramic cap., 50V	2012	C2012X7R1H475K125AC	TDK
CIN3	0.1uF	Ceramic cap., 50V	1608	C1608X7R1H104K080AE	TDK
CL1	10uF	Ceramic cap., 10V	2012	C2012X7R1A106K125AC	TDK
CL2	10uF	Ceramic cap., 10V	2012	C2012X7R1A106K125AC	TDK
RFB1	51kΩ	Resistor	1005	-	-
RFB2	15kΩ	Resistor	1005	-	-
CFB	220pF	Ceramic cap., 50V, CH	1005	-	-
RSS	Jumper	Resistor	-	-	-
CSS	-	-	-	-	-
RPG	100kΩ	Resistor	-	-	-

Additional Demo Board Circuit Components

Item	Value	Description	Size [mm]	Part Number	Manufacture
CBLK	10uF	Ceramic cap., 50V/10uF	3225	CGA6P3X7S1H106K	TDK

Vout Setting Table

Vout Setting	RFB1	RFB2	CFB
3.3V	51kΩ	15kΩ	220pF
5.0V	68kΩ	12kΩ	150pF

XCL230B0K1H2 Evaluation Board

36V, 600mA Inductor Built-in Step-down "micro DC/DC" Converter

PCB Layout

Layer 1

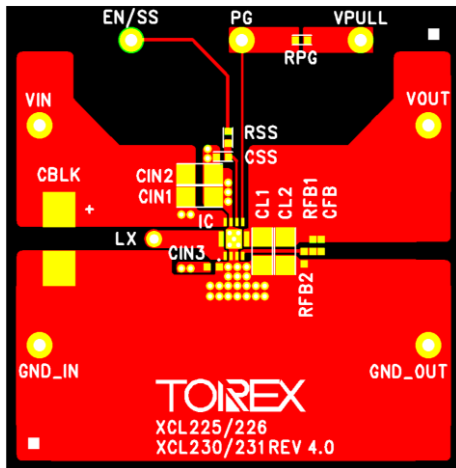

Layer 2

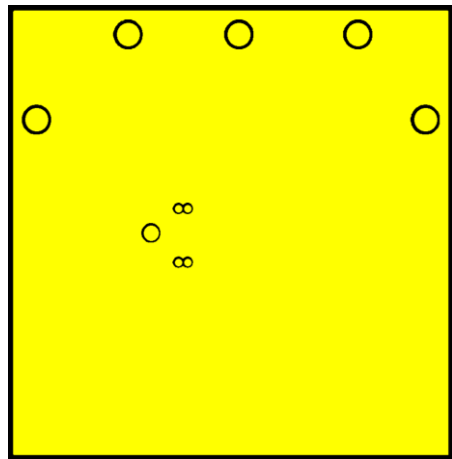

Layer 3

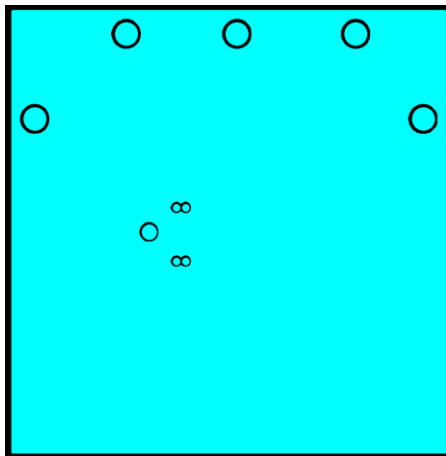

Layer 4

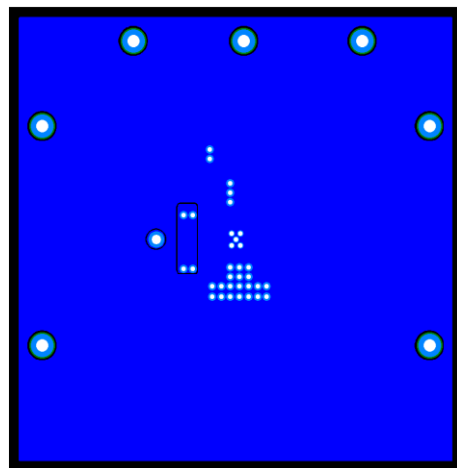

XCL230B0K1H2 Evaluation Board

36V, 600mA Inductor Built-in Step-down "micro DC/DC" Converter

Test Result

(1) Output Voltage vs Output Current @Ta=25°C

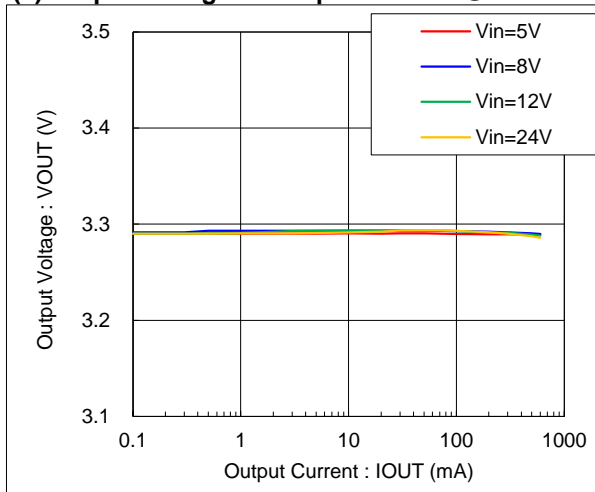

(2) Efficiency vs Output Current Ta=25°C

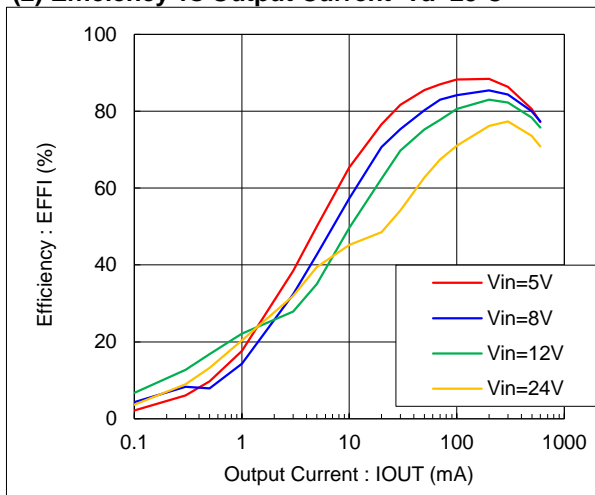

(3) Ripple Voltage vs Output Current Ta=25°C

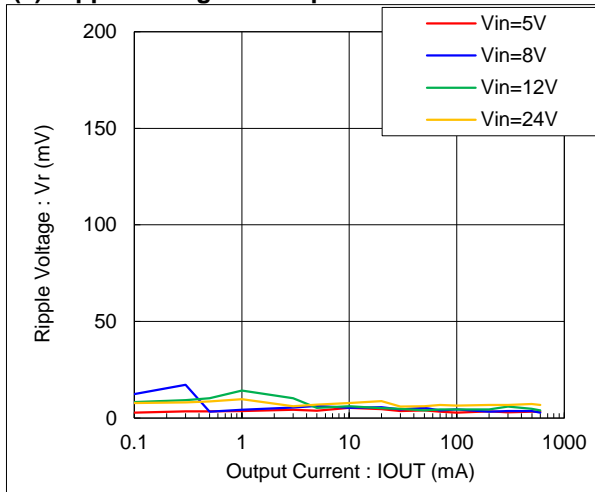

XCL230B0K1H2 Evaluation Board

36V, 600mA Inductor Built-in Step-down "micro DC/DC" Converter

Test Result

(4) Output Voltage Waveform @ Ta=25°C

(4-1) Vin = 12V, Iout = 50mA

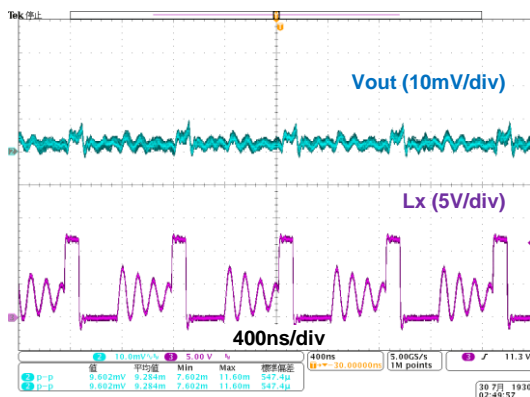

(4-2) Vin = 12V, Iout = 300mA

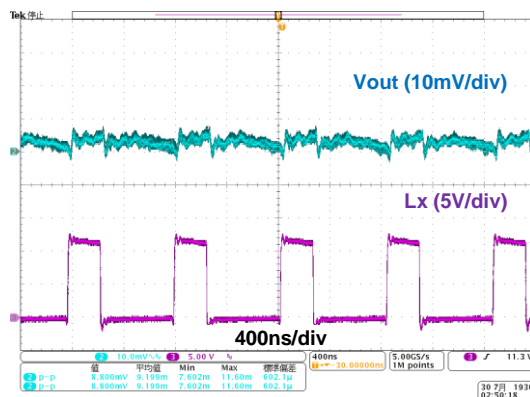

(4-3) Vin = 24V, Iout = 50mA

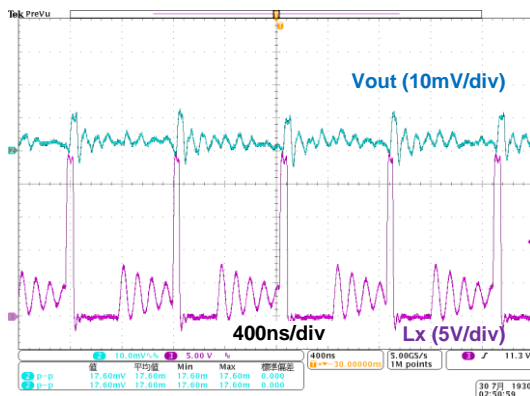

(4-4) Vin = 24V, Iout = 300mA

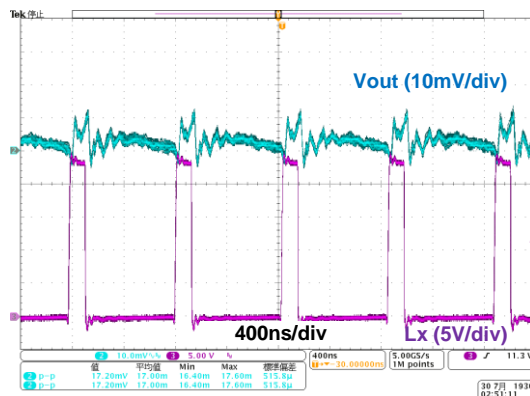

XCL230B0K1H2 Evaluation Board

36V, 600mA Inductor Built-in Step-down "micro DC/DC" Converter

Test Result

(5) Start-up Waveform @ Ta=25°C

(5-1) Vin = 12V, Iout = 10mA

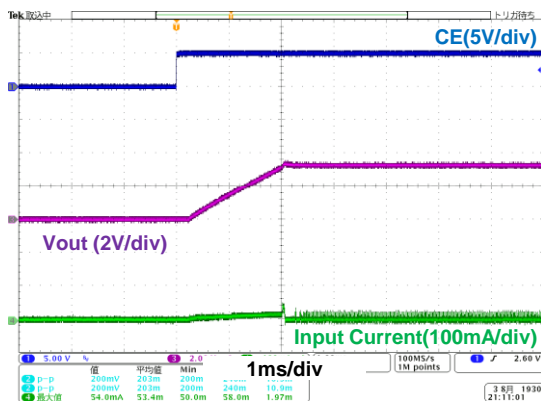

(5-2) Vin = 12V, Iout = 300mA

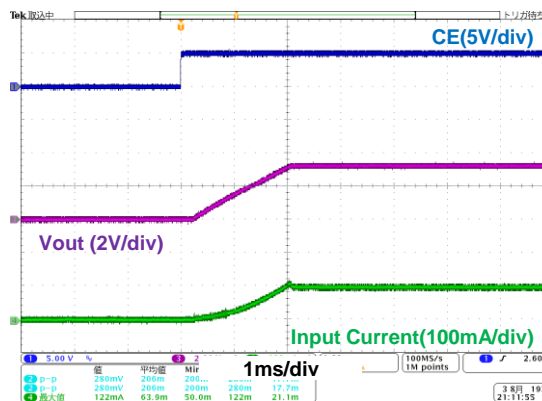

(5-3) Vin = 24V, Iout = 10mA

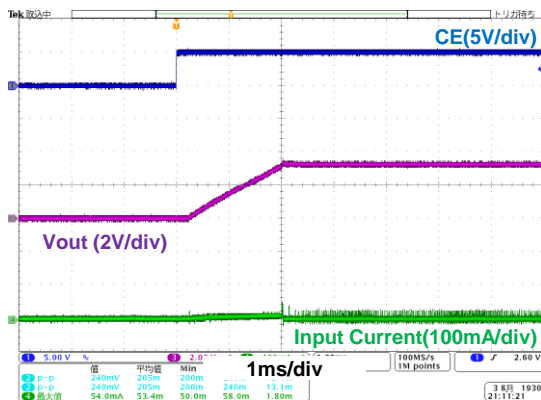

(5-4) Vin = 24V, Iout = 300mA

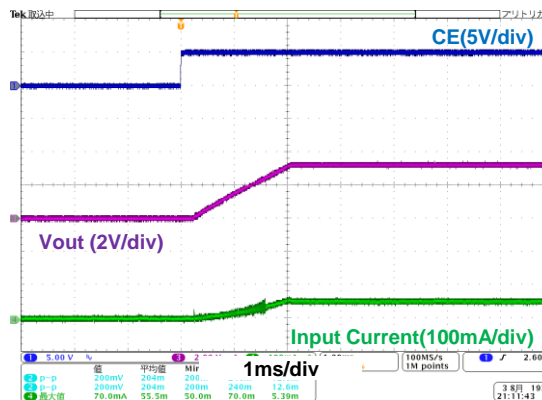

XCL230B0K1H2 Evaluation Board

36V, 600mA Inductor Built-in Step-down "micro DC/DC" Converter

Test Result

(6) Load Transient Waveform @ Ta=25°C

(6-1) Vin = 12V, Iout = 1mA ⇔ 200mA

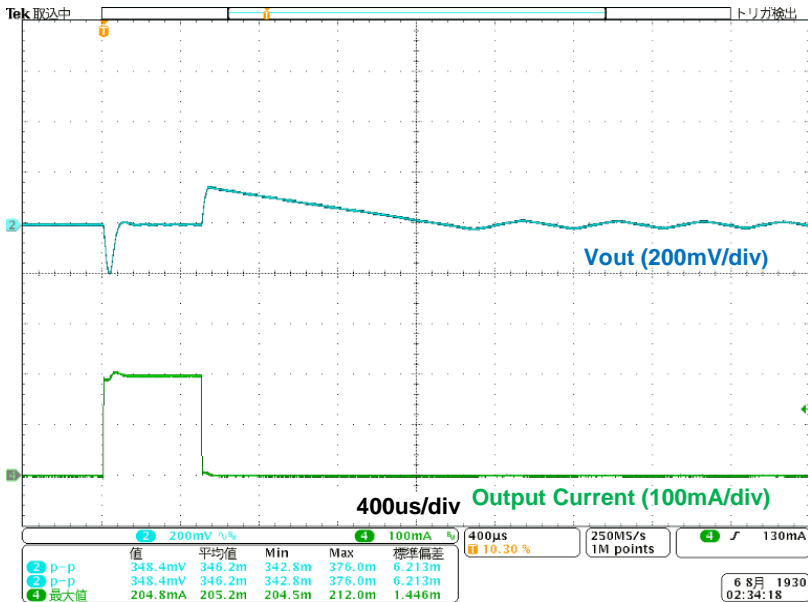

(6-2) Vin = 24V, Iout = 1mA ⇔ 200mA

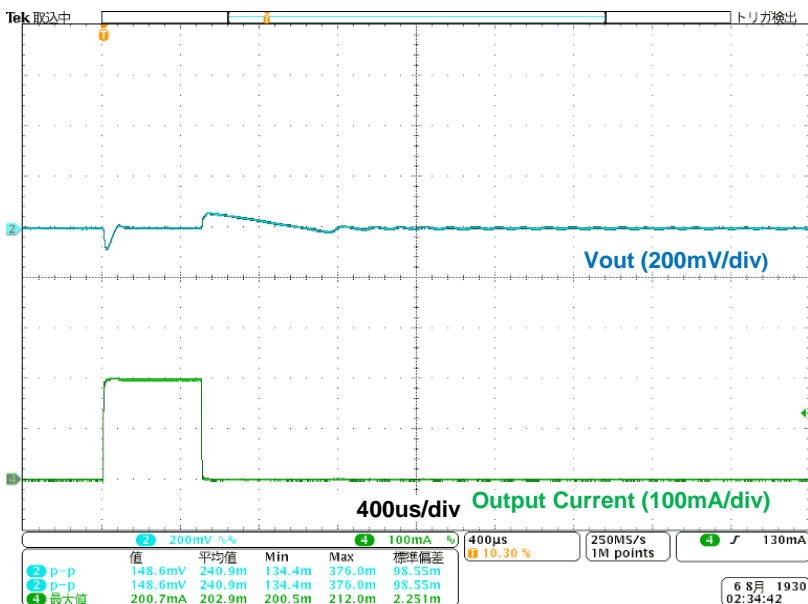

XCL230B0K1H2 Evaluation Board

36V, 600mA Inductor Built-in Step-down "micro DC/DC" Converter

Test Result

(7) Radiation EMI : VCCI 10m

Condition

IC : XCL230B0K1H2-G
 Vin : 12V
 Vout : 5V
 Iout : 300mA

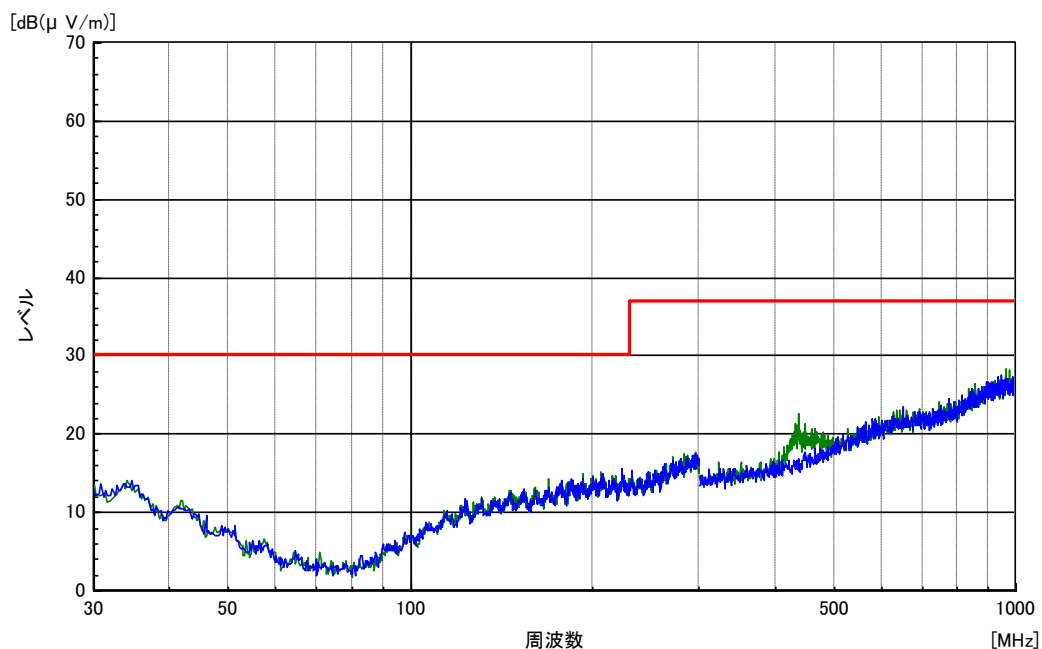

XCL230B0K1H2 Evaluation Board

36V, 600mA Inductor Built-in Step-down "micro DC/DC" Converter

【Appendix】 How to calculate DC/DC Converter or DC/DC Controller.

It can be calculated by the following "WEB DC/DC Simulation".

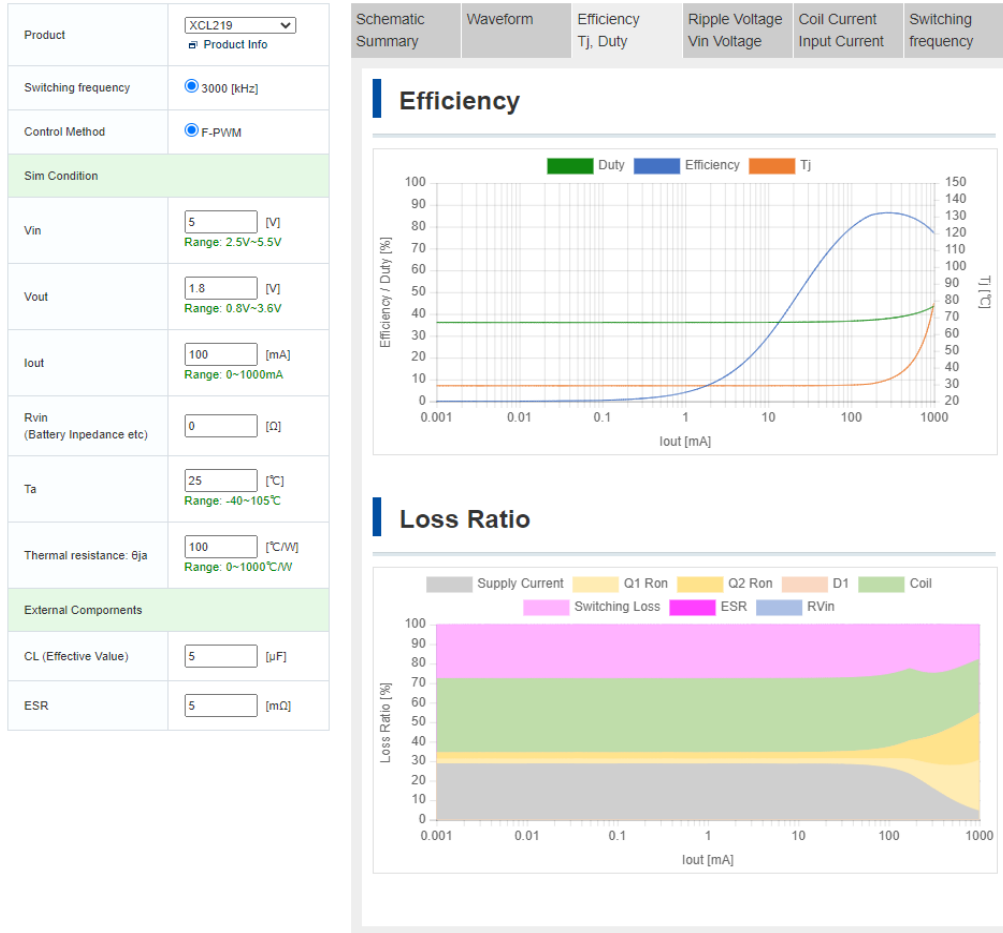

- 日本語 : <https://www.torex.co.jp/technical-support/dcdc-simulation/>
- English : <https://www.torexsemi.com/technical-support/dcdc-simulation/>
- 简体中文 : <https://www.torex.com.cn/technical-support/dcdc-simulation/>

XCL230B0K1H2 Evaluation Board

36V, 600mA Inductor Built-in Step-down "micro DC/DC" Converter

[Appendix] How to reduce the spike noise caused by measurement (Probing method with oscilloscope)

Probing method : Before improvement

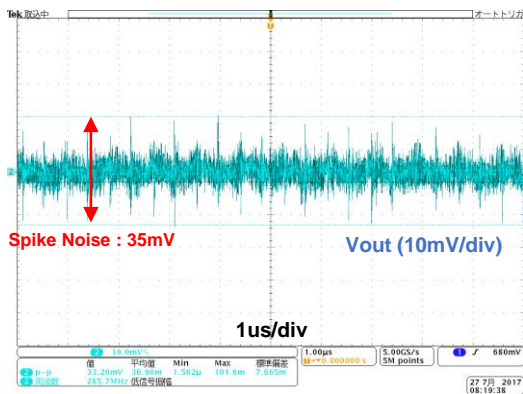
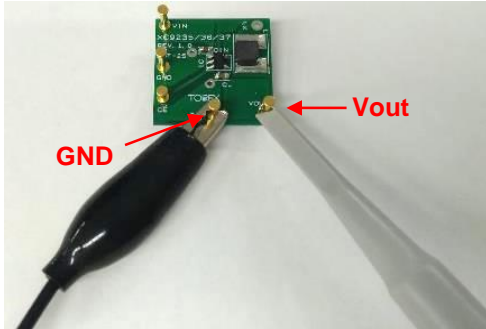

Probing method : After

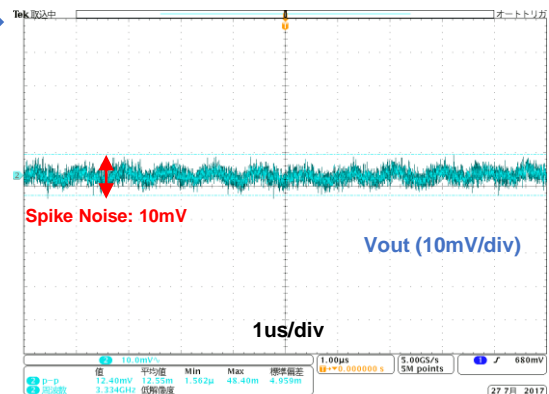
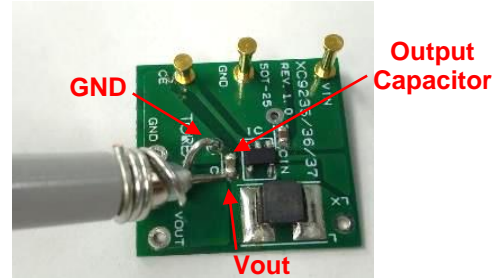

* Condition : XC9236, Vin=3.6V/Vout=1.8V/100mA

English : <https://www.torexsemi.com/technical-support/tips/reduction-spike-noise/>

日本語 : <https://www.torex.co.jp/technical-support/tips/reduction-spike-noise/>