



# MPQ8875A

## 36V, 5A, Four-Switch, Synchronous Buck-Boost Converter with I<sup>2</sup>C Interface, AEC-Q100 Qualified

### DESCRIPTION

The MPQ8875A is a 36V, monolithic, synchronous buck-boost DC/DC converter. The wide 2.2V to 36V input voltage range makes this device well-suited for multi-purpose automotive and industrial applications. The proprietary constant-on-time (COT) control, as well as the fully integrated, four-switch configuration, allow the chip to flexibly change the converter topology between buck, boost, and buck-boost mode. This optimizes performance and efficiency with input voltages that are above, below, or equal to the output voltage. It also ensures seamless transitions between the adjacent operational regions.

The MPQ8875A is controlled separately via a standard I<sup>2</sup>C interface. The various parameters can be adjusted by writing the settings to the device without any hardware changes required.

The switching frequency can be configured between 200kHz and 1MHz, or it can be synchronized between 250kHz and 1MHz via an external clock signal. In addition, the configurable frequency spread spectrum function can dither the switching frequency periodically for improved EMI performance.

Robust fault protections include input under-voltage lockout (UVLO), input over-voltage protection (OVP), cycle-by-cycle peak current limiting, output OVP, output short-circuit protection (SCP), and thermal shutdown. The built-in power good function can indicate whether the output voltage is regulated properly.

The MPQ8875A is available in a thermally enhanced QFN-34 (4mmx5mm) package.

### FEATURES

- 2.2V to 36V Wide Input Voltage Range
- Up to 5A Continuous Output Current
- <25 $\mu$ A Shutdown Current
- 180 $\mu$ A Quiescent Current when  $V_{IN} = 12V$
- Single-Channel, Four-Switch, Synchronous Buck-Boost Configuration:
  - Internal 10m $\Omega$  Buck High-Side Power MOSFET
  - Internal 25m $\Omega$  Buck Low-Side Synchronous Rectifier
  - Internal 10m $\Omega$  Boost Low-Side Power MOSFET
  - Internal 25m $\Omega$  Boost High-Side Synchronous Rectifier
- Proprietary Constant-On-Time (COT) Control for Seamless Transitions
- Internal Soft-Start
- Smart Power Good Output
- Easy-to-Optimize Efficiency and EMI Performance:
  - Configurable 200kHz to 1MHz Switching Frequency
  - Synchronizable Switching Frequency from 250kHz to 1MHz
  - Switching Frequency Spread Spectrum
  - Configurable Switching Speed
- Protection Features:
  - Cycle-by-Cycle Current Limiting
  - Over-Current Protection (OCP)
  - Configurable Input Under-Voltage Lockout (UVLO)
  - Output Over-Voltage Protection (OVP)
  - Input Over-Voltage Protection (OVP)
  - Output Short-Circuit Protection (SCP)
  - Over-Temperature Shutdown

## FEATURES *(continued)*

- Standard, Configurable I<sup>2</sup>C Interface:
  - Converter On/Off
  - Input Range Selection
  - Output Range from 0.5V to 30V for CCM, 5V to 30V for DCM
  - Switching Frequency
  - Synchronized Input/Output Selection
  - Switching Slew Rate
  - Frequency Spread Spectrum Setting
  - Compensation Network
  - Ramp Compensation
  - Soft-Start Time
  - Dynamic Output Voltage Adjustment with Slew Rate Control
  - Converter Mode Transition Threshold
  - Discontinuous Conduction Mode (DCM) or Forced Continuous Conduction Mode (FCCM)
  - Constant-On-Time (COT) Control of the Boost Switch in Buck-Boost Mode
  - Input Over-Voltage Protection (OVP)
  - Output Over-Voltage Protection (OVP)
  - Cycle-by-Cycle Current Limit Threshold
  - Reverse Current Limit Threshold
  - Over-Current Protection (OCP)
  - Output Short-Circuit Protection (SCP)
  - Thermal Protection
  - Power Good (PG) Threshold
  - Junction Temperature Reading
- One-Time Programmable (OTP) for Default Parameter Setting
- Available in QFN-34 (4mmx5mm) Package
- Available with Wettable Flanks
- Available in AEC-Q100 Grade 1

## APPLICATIONS

- Sensor Fusion Systems
- Camera Monitor Systems
- Infotainment Systems
- Automotive Applications

---

All MPS parts are lead-free, halogen free, and adhere to the RoHS directive. For MPS green status, please visit the MPS website under Quality Assurance. "MPS", the MPS logo, and "Simple, Easy Solutions" are registered trademarks of Monolithic Power Systems, Inc. or its subsidiaries.

## TYPICAL APPLICATION

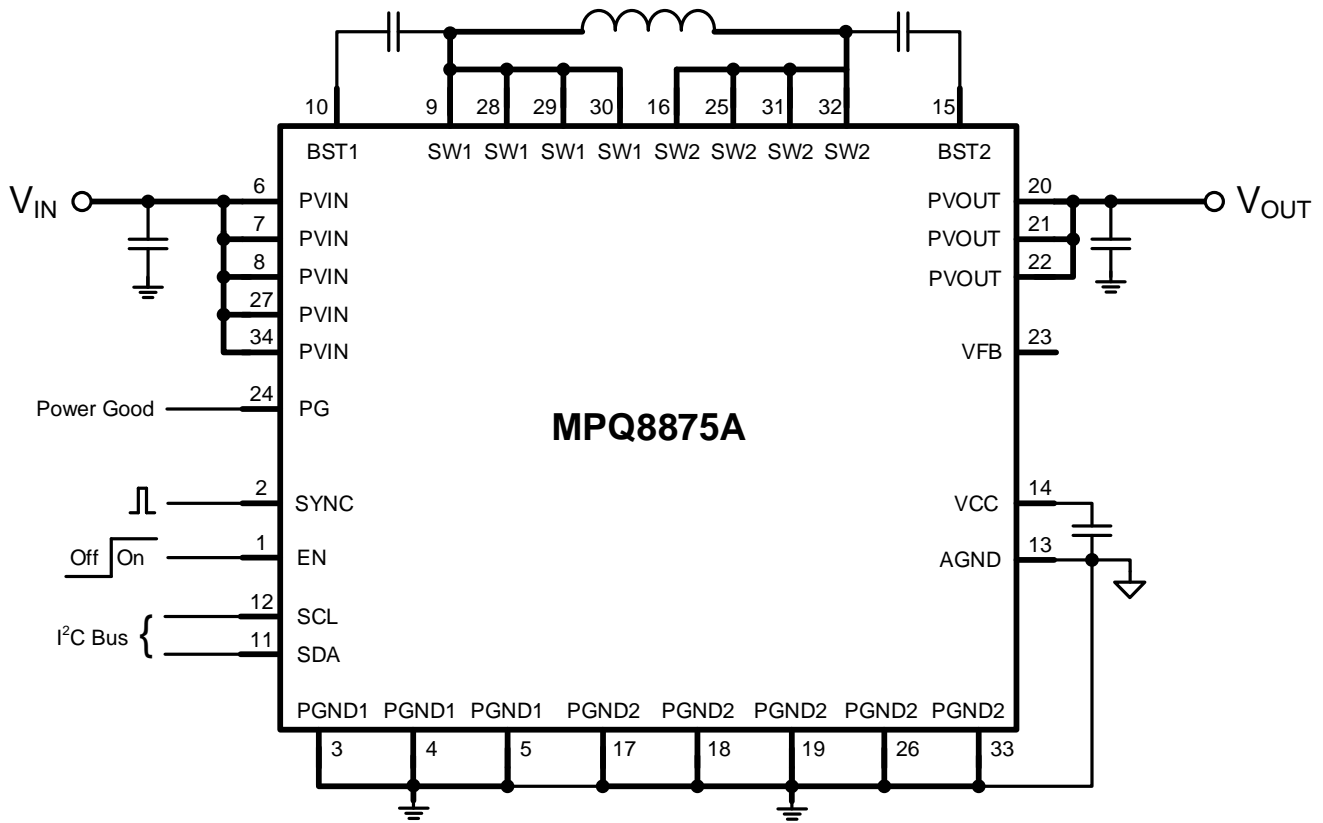

**Efficiency vs. Load Current**

$V_{OUT} = 11.5V$ ,  $f_{sw} = 450kHz$ , FCCM,  
 $L = 10\mu H$  (23m $\Omega$  DCR),  $I_{OUT} = 10mA$  to 1A

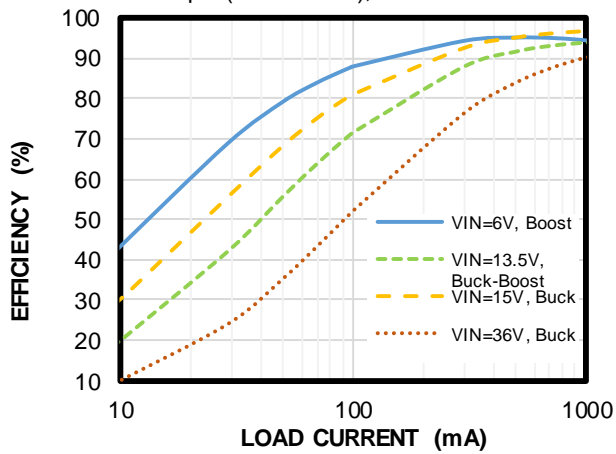

**Efficiency vs. Load Current**

$V_{OUT} = 11.5V$ ,  $f_{sw} = 450kHz$ , FCCM,  
 $L = 10\mu H$  (23m $\Omega$  DCR),  $I_{OUT} = 0.5A$  to 5A

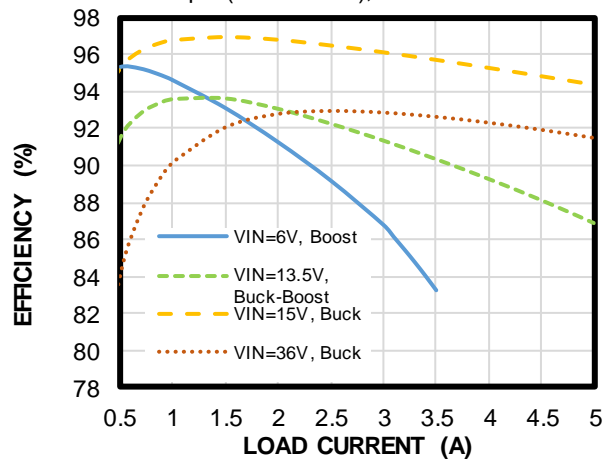

## ORDERING INFORMATION

Part Number*	Package	Top Marking	MSL Rating***
MPQ8875AGVE-xxxx**, ****	QFN-34 (4mmx5mm)	<i>See Below</i>	1
MPQ8875AGVE-xxxx-AEC1****	QFN-34 (4mmx5mm)		

\* For Tape & Reel, add suffix –Z (e.g. MPQ8875AGVE-xxxx–Z).

\*\* “xxxx” is the configuration code identifier for the register settings stored in the OTP register. Each “x” can be a hexadecimal value between 0 and F. Contact an MPS FAE to create this unique number.

\*\*\* Moisture Sensitivity Level Rating

\*\*\*\* Wettable Flank

## TOP MARKING

MPSYWW  
**M8875A**  
**LLLLLL**  
**E**

MPS: MPS prefix  
 Y: Year code  
 WW: Week code  
 M8875A: Part number  
 LLLLLL: Lot number  
 E: Wettable Flank

## PACKAGE REFERENCE

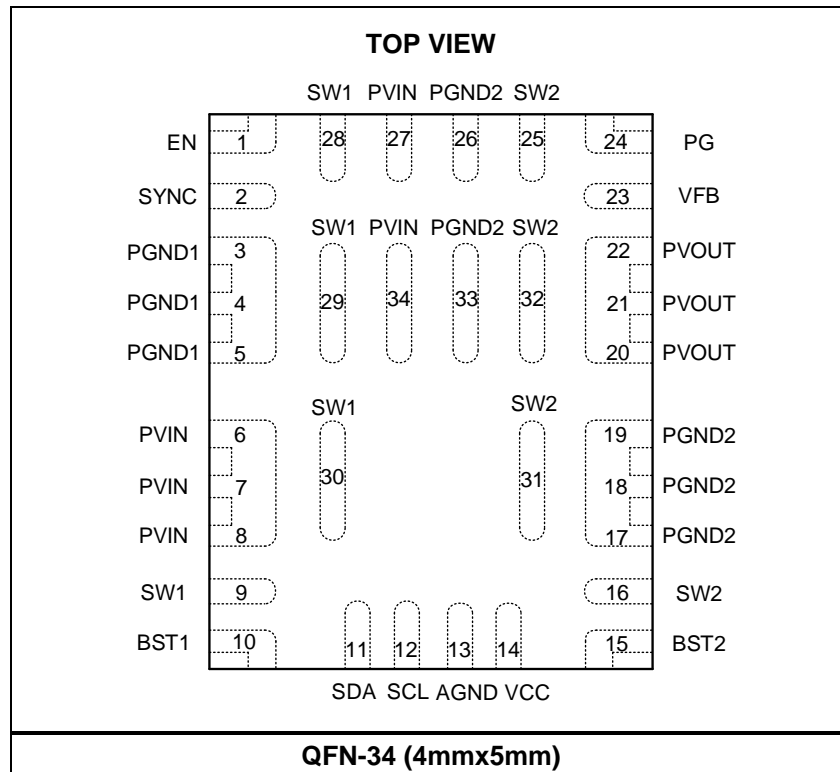

## PIN FUNCTIONS

Pin #	Name	Description
1	EN	<b>On/off control input and custom input UVLO setting.</b> The EN pin can be driven by an external logic signal to enable or disable the chip. Pull EN below the specified threshold (about 1.4V) to shut down the chip. Pull EN above the specified threshold (about 1.55V) to enable the chip. Connect a resistor divider from the input voltage (PVIN pin) to the EN pin to set a customer-accurate under-voltage lockout (UVLO) threshold for the input voltage. A 1.3µA internal pull-up current source is enabled when the EN voltage is above its high threshold (about 1.55V). A 1MΩ internal resistor pulls the EN pin low when it is floating. This means that the part is off by default when there is no external pull-up voltage.
2	SYNC	<b>Synchronization input or output.</b> The SYNC pin can be configured through the I <sup>2</sup> C to synchronization input or output mode. In synchronization input mode, the chip synchronizes its switching with the external clock connected to this pin. The external clock frequency must be 20% greater than the configured frequency set in the OTP register. In synchronization output mode, the chip outputs its clock signal to synchronize the other chip's switching clock. Float the SYNC pin if it is not used.
3, 4, 5	PGND1	<b>Power ground for the SW1 half-bridge.</b> The three PGND1 pins are connected inside the MPQ8875A. These pins should be electrically connected to the system power ground plane with the shortest and lowest-impedance connection possible.
6, 7, 8, 27, 34	PVIN	<b>Power input for the converter.</b> Connect a large bulk input capacitor to PVIN for a stable power source, and connect bypass capacitors from PVIN to PGND1 to reduce noise. Inside the chip, three of the PVIN pins (pins 6, 7, and 8) are connected together. The two remaining PVIN pins (pins 27 and 34) are also connected together. Both sets of PVIN pins require a bypass capacitor. The bypass capacitors should be placed as close to the chip as possible. The input voltage (V <sub>IN</sub> ) is supplied by the PVIN pin.
9, 28, 29, 30	SW1	<b>Power switch output 1.</b> The four SW1 pins (pins 9, 28, 29, and 30) are connected together inside the chip. These pins should be connected to one side of the external power inductor.
10	BST1	<b>Bootstrap for SW1.</b> Place a capacitor between SW1 and BST1 to form a floating supply across the SW1 upper power switch driver. Generally, a 100nF ceramic capacitor is required to drive the SW1 upper power switch's gate above SW1's level.
11	SDA	<b>I<sup>2</sup>C bus serial data input/output.</b> This pin is an open-drain port. An external pull-up resistor is required to connect this pin to the I <sup>2</sup> C bus supply rail. If SDA is not used, it is recommend to connect SDA to the VCC pin through a resistor.
12	SCL	<b>I<sup>2</sup>C bus serial clock input.</b> This pin is an open-drain port. An external pull-up resistor is required to connect this pin to the I <sup>2</sup> C bus supply rail. If SCL is not used, it is recommend to connect SCL to the VCC pin through a resistor.
13	AGND	<b>Signal ground.</b> Ground for the internal logic and signal control blocks.
14	VCC	<b>5V internal regulator output.</b> VCC supplies power to the control blocks, I <sup>2</sup> C interface, and the power MOSFETs' gate driver. Bypass VCC to AGND with a 1µF to 10µF, external, low-ESR ceramic capacitor.
15	BST2	<b>Bootstrap for SW2.</b> Place a capacitor between SW2 and BST2 to form a floating supply across the SW2 upper power switch driver. A 100nF ceramic capacitor is typically required to drive the SW2 upper power switch's gate above SW2's level.
16, 25, 31, 32	SW2	<b>Power switch output 2.</b> The four SW2 pins (pins 16, 25, 31, and 32) are connected together inside the MPQ8875A. These pins should be connected to one side of the external power inductor.

**PIN FUNCTIONS (continued)**

Pin #	Name	Description
17, 18, 19, 26, 33	PGND2	<b>Power ground for SW2 half-bridge.</b> Three of the PGND2 pins (pins 17, 18, and 19) are connected inside the MPQ8875A. The two remaining PGND2 pins (pins 26 and 33) are also connected together. These five pins should be electrically connected to the system power ground plane through the shortest and lowest-impedance connection possible.
20, 21, 22	PVOUT	<b>Power output of the converter.</b> The three PVOUT pins (pins 20, 21, and 22) are connected together inside the MPQ8875A. The output capacitors should be placed as close to the chip as possible, with a short return path to the ground plane. In addition, connect a bypass capacitor from PVOUT to PGND2 to reduce noise. Place this capacitor as close to PVOUT as possible. The output voltage ( $V_{OUT}$ ) is supplied by the PVOUT pin.
23	VFB	<b>Feedback input.</b> Two modes are available for the VFB pin via the I <sup>2</sup> C, described below: <ul style="list-style-type: none"> <li>• No connection. Leave this pin floating.</li> <li>• Tie this pin to the internal error amplifier's feedback input, which is also connected to the tap of the internal PVOUT resistor divider. To improve system stability, add an external RC compensation network from VOUT to this pin. The external compensation network should be placed as close to the chip as possible. If the external compensation is not used, leave this pin floating.</li> </ul>
24	PG	<b>Power good indicator.</b> This pin is an open-drain status pin that indicates if the output voltage is within its allowable window. Connect PG to VCC with a resistor (e.g. 100k $\Omega$ ). After soft start ends, the PG pin asserts low when the output voltage is not within the allowable window. Float this pin if it is not used.

**ABSOLUTE MAXIMUM RATINGS** <sup>(1)</sup>

PVIN, PVOOUT .....	-0.3V to +42V
V <sub>SW1</sub> .....	-0.3V to PVIN + 0.3V
V <sub>SW2</sub> .....	-0.3V to PVOOUT + 0.3V
V <sub>BST1</sub> .....	(V <sub>SW1</sub> - 0.3V) to (V <sub>SW1</sub> + 5.5V)
V <sub>BST2</sub> .....	(V <sub>SW2</sub> - 0.3V) to (V <sub>SW2</sub> + 5.5V)
All other pins .....	-0.3V to +5.5V
Continuous power dissipation (T <sub>A</sub> = 25°C) <sup>(2)</sup>	
QFN-34 (4mmx5mm) .....	4W
Junction temperature .....	150°C
Lead temperature .....	260°C
Storage temperature .....	-65°C to +150°C

**Electrostatic Discharge (ESD) Ratings**

Human body model (HBM) .....	±2000V
Charged device model (CDM) .....	±750V

**Recommended Operating Conditions**

Supply voltage (V <sub>IN</sub> ):	
Normal input mode.....	4.5V to 36V
Low input mode .....	2.2V to 36V
Output voltage (V <sub>OUT</sub> ) in CCM.....	0.5V to 30V
Output voltage (V <sub>OUT</sub> ) in DCM.....	5V to 30V
Operating junction temp (T <sub>J</sub> )....	-40°C to +150°C

<b>Thermal Resistance</b>	<b>θ<sub>JA</sub></b>	<b>θ<sub>JC</sub></b>
QFN-34 (4mmx5mm)		
JESD51-7 <sup>(3)</sup> .....	38.....8	..... °C/W
EVQ8875A-VE-00A <sup>(4)</sup> .....	31.....3	..... °C/W

**Notes:**

- 1) Exceeding these ratings may damage the device.
- 2) The maximum allowable power dissipation is a function of the maximum junction temperature, T<sub>J</sub> (MAX), the junction-to-ambient thermal resistance, θ<sub>JA</sub>, and the ambient temperature, T<sub>A</sub>. The maximum allowable continuous power dissipation at any ambient temperature is calculated by P<sub>D</sub> (MAX) = (T<sub>J</sub> (MAX) - T<sub>A</sub>) / θ<sub>JA</sub>. Exceeding the maximum allowable power dissipation can cause excessive die temperature, and the regulator may go into thermal shutdown. Internal thermal shutdown circuitry protects the device from permanent damage.
- 3) Measured on JESD51-7, 4-layer PCB. The value of θ<sub>JA</sub> given in this table is only valid for comparison with other packages, and cannot be used for design purposes. These values were calculated in accordance with JESD51-7, and simulated on a specified JEDEC board. They do not represent the performance obtained in an actual application.
- 4) Measured on EVQ8875A-VE-00A, 4-layer, 9cmx9cm PCB, 2oz copper.



## ELECTRICAL CHARACTERISTICS

Typical values are at  $V_{IN} = 12V$ ,  $V_{EN} = 2V$ ,  $T_J = 25^{\circ}C$ , all voltages with respect to ground, unless otherwise noted. Minimum and maximum values are at  $V_{IN} = 12V$ ,  $V_{EN} = 2V$ ,  $T_J = -40^{\circ}C$  to  $+150^{\circ}C$ , all voltages with respect to ground, guaranteed by characterization, unless otherwise noted.

Parameters	Symbol	Condition	Min	Typ	Max	Units
<b>Input Supply Voltage</b>						
Input operating range	$V_{IN}$	Normal input mode	4.5		36	V
		Low input mode, $V_{CC} \geq 2.5V$	2.2		36	V
Input under-voltage lockout (UVLO) threshold	$V_{IN\_UVLO}$	Normal input mode, $V_{IN}$ falling edge	3.2	3.6	4.2	V
		Low input mode, $V_{IN}$ falling edge	1.8	2.0	2.2	V
Input UVLO hysteresis	$V_{IN\_UVLO\_HYS}$	Normal input mode		250		mV
		Low input mode		225		
Minimum input start-up voltage <sup>(7)</sup>	$V_{IN\_STARTUP}$	Low input mode, $V_{IN}$ rising edge, $V_{CC}$ is powered from $V_{IN}$ , $I_{CC} = 10mA$			3	V
<b>Input Supply Current</b>						
Shutdown current	$I_{IN\_SD}$	$V_{EN} = 0V$ , $T_J = 25^{\circ}C$			5	$\mu A$
		$V_{EN} = 0V$ , $T_J = -40^{\circ}C$ to $+150^{\circ}C$			25	
Quiescent current (normal)	$I_{IN\_Q\_NOR}$	$V_{IN} = 12V$ , no switching		180	500	$\mu A$
		$V_{IN} = 24V$ , no switching		180	500	$\mu A$
Quiescent current (fault)	$I_{IN\_Q\_FLT}$	Fault latch condition		180	500	$\mu A$
Active current (normal) <sup>(6)</sup>	$I_{Q\_ACT\_NOR}$	$V_{IN} = 12V$ , $V_{OUT} = 11.5V$ , no load, buck-boost mode, SW1/SW2 switching	CCM		33	mA
			DCM		0.31	mA
		$V_{IN} = 24V$ , $V_{OUT} = 11.5V$ , no load, buck mode, SW1 switching	CCM		25	mA
			DCM		0.4	mA
<b>VCC Regulator</b>						
Regulator output voltage	VCC	$V_{IN} = 12V$ , $V_{OUT} = 5V$ , $I_{CC} = 1mA$	4.85	5.1	5.35	V
		$V_{IN} = 3V$ , $V_{OUT} = 5V$ , $I_{CC} = 1mA$	4.65	4.85		V
VCC line regulation		$V_{IN} = 5.5V$ to $36V$ , $I_{CC} = 1mA$	-0.5		+0.5	%
VCC load regulation		$I_{CC} = 1mA$ to $30mA$	-0.7		+0.7	%
Dropout voltage	$V_{CC\_DRV}$	$V_{IN} = 2.7V$ , $V_{OUT} = 2.5V$ , $I_{CC} = 5mA$		100	220	mV
		$V_{OUT} = 2.7V$ , $V_{IN} = 2.5V$ , $I_{CC} = 5mA$		80	500	mV
Short circuit current limitation	$I_{CC\_MAX}$	$V_{CC} = 0V$	40	60	100	mA



## ELECTRICAL CHARACTERISTICS (continued)

Typical values are at  $V_{IN} = 12V$ ,  $V_{EN} = 2V$ ,  $T_J = 25^\circ C$ , all voltages with respect to ground, unless otherwise noted. Minimum and maximum values are at  $V_{IN} = 12V$ ,  $V_{EN} = 2V$ ,  $T_J = -40^\circ C$  to  $+150^\circ C$ , all voltages with respect to ground, guaranteed by characterization, unless otherwise noted.

Parameters	Symbol	Condition	Min	Typ	Max	Units
<b>VCC Regulator</b>						
VCC UVLO threshold	$V_{CCUVLO}$	Normal input mode, VCC falling edge	3.2	3.4	3.6	V
		Low input mode, VCC falling edge	2.1	2.25	2.4	V
VCC UVLO hysteresis	$V_{CCUVLO\_HYS}$			350		mV
<b>Oscillator</b>						
Switching frequency range <sup>(5)</sup>	$f_{SW}$		200		1000	kHz
Frequency PLL accuracy <sup>(6)</sup>		$f_{SW}$ = default value in OTP register 0x03h, bits[5:0]	-15		+15	%
Minimum on time <sup>(7)</sup>	$t_{ON\_MIN}$			100		ns
Minimum off time <sup>(7)</sup>	$t_{OFF\_MIN}$	Buck mode		90		ns
		Boost mode		180		ns
Synchronization frequency range	$f_{SYNC}$	Sync clock input mode	250		1000	kHz
SYNC input logic high threshold	$V_{SYNC\_IN\_H}$	$V_{SYNC}$ rising edge	1.4			V
SYNC input logic low threshold	$V_{SYNC\_IN\_L}$	$V_{SYNC}$ falling edge			0.5	V
SYNC input minimum logic high pulse width	$t_{SYNC\_IN\_PW\_MIN}$		200			ns
SYNC output logic high <sup>(7)</sup>	$V_{SYNC\_OUT\_H}$			VCC		
SYNC output logic low <sup>(7)</sup>	$V_{SYNC\_OUT\_L}$				0.3	V
SYNC output duty cycle	$D_{SYNC\_OUT}$			50		%
<b>Frequency Spread Spectrum</b>						
Spread spectrum modulation frequency spread range <sup>(5)</sup>	$f_{FSS}$		±3%		±30%	$f_{SW}$
Spread spectrum modulation frequency range <sup>(5)</sup>	$f_{FSSM}$		0.25		8	kHz
<b>Enable</b>						
Logic enable threshold	$V_{EN\_LOGIC}$		0.5	0.85	1.15	V
System enable threshold	$V_{EN\_ON}$	$V_{EN}$ rising edge	1.4	1.55	1.7	V
Pull-up hysteresis current	$I_{EN\_HYS}$	After converter works		1.3		μA
Hysteresis voltage	$V_{EN\_SYS}$			150		mV
<b>Bootstrap</b>						
Biased voltage for high-side driver (Q1/Q3)	$V_{BST1}-V_{SW1}$	$V_{CC} = 5V$	4.3	4.7	5.1	V
	$V_{BST2}-V_{SW2}$					
	$V_{BST1}-V_{SW1}$	$V_{CC} = 2.55V$	1.6			
	$V_{BST2}-V_{SW2}$		1.4			
BST UVLO	$V_{BST1/2\_UVLO}$	$V_{BST1/2} - V_{SW1/2}$ falling edge	1.1	1.6	2.1	V
BST UVLO hysteretic	$V_{BST1/2\_UVLO\_HYS}$			80		mV

**ELECTRICAL CHARACTERISTICS (continued)**

Typical values are at  $V_{IN} = 12V$ ,  $V_{EN} = 2V$ ,  $T_J = 25^\circ C$ , all voltages with respect to ground, unless otherwise noted. Minimum and maximum values are at  $V_{IN} = 12V$ ,  $V_{EN} = 2V$ ,  $T_J = -40^\circ C$  to  $+150^\circ C$ , all voltages with respect to ground, guaranteed by characterization, unless otherwise noted.

Parameters	Symbol	Condition	Min	Typ	Max	Units
<b>Power Switches</b>						
Main switch (Q1/Q3) on resistance	$R_{DS(ON\_MAIN)}$	$V_{CC} = 5V$ , $T_J = 25^\circ C$		10	20	m $\Omega$
		$V_{CC} = 5V$ , $T_J = -40^\circ C$ to $+150^\circ C$		10	25	
		Low-input mode, $V_{CC} = 2.55V$ , $T_J = 25^\circ C$		15	20	m $\Omega$
		Low-input mode, $V_{CC} = 2.55V$ , $T_J = -40^\circ C$ to $+150^\circ C$		15	30	
Synchronous rectifier switch (Q2/Q4) on resistance	$R_{DS(ON\_SR)}$	$V_{CC} = 5V$ , $T_J = 25^\circ C$		25	40	m $\Omega$
		$V_{CC} = 5V$ , $T_J = -40^\circ C$ to $+150^\circ C$		25	50	
		Low-input mode, $V_{CC} = 2.55V$ , $T_J = 25^\circ C$		35	45	m $\Omega$
		Low-input mode, $V_{CC} = 2.55V$ , $T_J = -40^\circ C$ to $+150^\circ C$		35	60	
Switch leakage current	$I_{SW\_LKG}$	$V_{SW1/SW2} = 36V$ , $T_J = 25^\circ C$			1	$\mu A$
		$V_{SW1/SW2} = 36V$ , $T_J = -40^\circ C$ to $+150^\circ C$			20	
Peak current limit range <sup>(5)</sup>	$I_{LMT\_PK}$	$I_L$ rising edge	2		9	A
Peak current limit accuracy <sup>(6)</sup>		$I_{LMT\_PK} = 9A$	9	12		A
Reverse current limit range <sup>(5)</sup>	$I_{LMT\_RV}$	FCCM, $I_L$ falling edge	-2.5		-4.7	A
Reverse current limit accuracy		$I_{LMT\_RV} = -2.5A$	-1.8	-2.5	-3.5	A
		$I_{LMT\_RV} = -4.7A$	-3.8	-4.7	-6.5	
Valley current limit range <sup>(5)</sup>	$I_{LIMIT\_VL}$	OC fault triggers	1		8	A
Valley current limit accuracy <sup>(6)</sup>		$I_{LIMIT\_VL} = +8A$ , $I_{LIMIT\_RV} = -2.5A$	6.64	8	9.36	A
		$I_{LIMIT\_VL} = +8A$ , $I_{LIMIT\_RV} = -4.7A$	5.6	7	8.4	
Zero-current detection (ZCD) threshold	$I_{ZCD}$	DCM, $I_L$ falling edge		100		mA
Switching slew rate range <sup>(5)</sup>	$SR_R$	$V_{SW1/2}$ rising edge	1		2	V/ns
	$SR_F$	$V_{SW1/2}$ falling edge	1		2	V/ns

## ELECTRICAL CHARACTERISTICS *(continued)*

Typical values are at  $V_{IN} = 12V$ ,  $V_{EN} = 2V$ ,  $T_J = 25^{\circ}C$ , all voltages with respect to ground, unless otherwise noted. Minimum and maximum values are at  $V_{IN} = 12V$ ,  $V_{EN} = 2V$ ,  $T_J = -40^{\circ}C$  to  $+150^{\circ}C$ , all voltages with respect to ground, guaranteed by characterization, unless otherwise noted.

Parameters	Symbol	Condition	Min	Typ	Max	Units
<b>Output Voltage Regulation</b>						
Output voltage range	$V_{OUT}$		0.5		30	V
PVOUT leakage current	$I_{OUT\_LKG}$	$V_{IN} = V_{EN} = 0V$ , $V_{OUT} = 12V$		20	60	$\mu A$
Reference voltage range <sup>(5)</sup>	$V_{REF}$	Normal input mode	0.5		2.0	V
		Low-input mode	0.5		1.2	V
Reference voltage accuracy		$V_{REF} = 0.5V/1.2V/1.5V/2V$ , $T_J = 25^{\circ}C$	-2		+2	%
		$V_{REF} = 0.5V/1.2V/1.5V/2V$ , $T_J = -40^{\circ}C$ to $+125^{\circ}C$ <sup>(7)</sup>	-2.5		+2.5	
		$V_{REF} = 0.5V/1.2V/1.5V/2V$ , $T_J = -40^{\circ}C$ to $+150^{\circ}C$	-3		+3	
Output divider ratio range <sup>(5)</sup>	$V_{REF}/V_{OUT}$		1/30		1	
Dynamic adjustment step interval range <sup>(5)</sup>	$t_{DV\_STEP}$		20		166.67	$\mu s$
Dynamic adjustment step interval accuracy <sup>(6)</sup>		$t_{DV\_STEP}$ = default value in OTP register 0x01h, bits[4:3]	-15		+15	%
VFB current	$I_{FB}$	$V_{FB} = 2V$	-100		+100	nA

## ELECTRICAL CHARACTERISTICS (continued)

Typical values are at  $V_{IN} = 12V$ ,  $V_{EN} = 2V$ ,  $T_J = 25^{\circ}C$ , all voltages with respect to ground, unless otherwise noted. Minimum and maximum values are at  $V_{IN} = 12V$ ,  $V_{EN} = 2V$ ,  $T_J = -40^{\circ}C$  to  $+150^{\circ}C$ , all voltages with respect to ground, guaranteed by characterization, unless otherwise noted.

Parameters	Symbol	Condition	Min	Typ	Max	Units
<b>Buck-Boost Converter</b>						
Boost out of threshold range <sup>(5)</sup>	$V_{IN\_BST\_OUT}$	$V_{IN}$ rising edge	0.7		0.9	$V_{OUT}$
Boost out of threshold accuracy		$V_{OUT} = 12V$	-0.04		+0.04	$V_{OUT}$
Boost transition hysteresis range <sup>(5)</sup>	$V_{IN\_BST\_HYS}$		0.05		0.125	$V_{OUT}$
Boost transition hysteresis accuracy		$V_{OUT} = 12V$	-0.03		+0.03	$V_{OUT}$
Buck in threshold range <sup>(5)</sup>	$V_{IN\_BK\_IN}$	$V_{IN}$ rising edge	1.1		1.3	$V_{OUT}$
Buck in threshold accuracy		$V_{OUT} = 12V$	-0.04		+0.04	$V_{OUT}$
Buck transition hysteresis range <sup>(5)</sup>	$V_{IN\_BK\_HYS}$		0.05		0.125	$V_{OUT}$
Buck transition hysteresis accuracy		$V_{OUT} = 12V$	-0.03		+0.03	$V_{OUT}$
COT range of boost switch in buck-boost mode <sup>(5) (7)</sup>	$t_{BST\_ON}$		0.2		0.5	t <sub>sw</sub>
<b>Input Over-Voltage Protection (OVP)</b>						
Input OVP threshold range <sup>(5)</sup>	$V_{IN\_OVP}$	$V_{IN}$ rising edge	11		33	V
Input OVP threshold accuracy			-10		+10	%
Input OVP hysteresis range <sup>(5)</sup>	$V_{IN\_OVP\_HYS}$		0.03		0.05	$V_{IN}$
Input OVP hysteresis accuracy			-0.02		+0.02	$V_{IN}$
<b>Output Over-Voltage Protection (OVP)</b>						
Output OVP threshold range <sup>(5)</sup>	$V_{OUT\_OVP}$	$V_{OUT}$ rising edge	1.1		1.3	$V_{REF}$
Output OVP threshold accuracy			-0.05		+0.05	$V_{REF}$
Output OVP recovery threshold range <sup>(5)</sup>	$V_{OUT\_OVP\_REC}$	$V_{OUT}$ falling edge	1		1.05	$V_{REF}$
Output OVP recovery threshold accuracy			-0.04		+0.04	$V_{REF}$
<b>Over-Current Protection (OCP)</b>						
OC fault activation delay time range <sup>(5) (7)</sup>	$t_{OCP\_DELAY}$	Consecutive switching count when COMP level is too high	32		256	t <sub>sw</sub>
<b>Output Under-Voltage Protection (UVP)</b>						
Output under-voltage (UV) threshold range <sup>(5)</sup>	$V_{OUT\_UVP}$	$V_{OUT}$ falling edge	0.5		0.75	$V_{REF}$
Output UV threshold accuracy			-0.04		+0.04	$V_{REF}$
Output UV fault activation delay time <sup>(5) (7)</sup>	$t_{UVP\_DELAY}$	Consecutive switching count when $V_{OUT} < V_{OUT\_UVP}$	2		16	t <sub>sw</sub>

## ELECTRICAL CHARACTERISTICS (continued)

Typical values are at  $V_{IN} = 12V$ ,  $V_{EN} = 2V$ ,  $T_J = 25^{\circ}C$ , all voltages with respect to ground, unless otherwise noted. Minimum and maximum values are at  $V_{IN} = 12V$ ,  $V_{EN} = 2V$ ,  $T_J = -40^{\circ}C$  to  $+150^{\circ}C$ , all voltages with respect to ground, guaranteed by characterization, unless otherwise noted.

Parameters	Symbol	Condition	Min	Typ	Max	Units
<b>Thermal Shutdown</b>						
Thermal shutdown threshold range <sup>(5) (7)</sup>	$T_{SD}$	$T_J$ rising	150		170	$^{\circ}C$
Thermal shutdown hysteresis range <sup>(5) (7)</sup>	$T_{HYS}$		25		75	$^{\circ}C$
<b>Fault Recovery Timer</b>						
Auto-recovery delay time range <sup>(5) (7)</sup>	$t_{FLT\_REC}$	Fault recovery mode is activated, except $T_{SD}$	2		16	ms
Fault reset delay timer <sup>(7)</sup>	$t_{FLT\_RST}$	After soft start ends during a recovery cycle, consecutive switching count when no fault is detected		30		$\mu s$
<b>Power Good Indicator (Open Drain)</b>						
Power good (PG) high limit range <sup>(5)</sup>	$V_{OUT\_PG\_H}$	$V_{OUT}$ rising edge	1.12		1.17	$V_{REF}$
PG high limit accuracy			-0.04		+0.04	$V_{REF}$
PG high limit hysteresis range <sup>(5)</sup>	$V_{OUT\_PG\_H\_HYS}$		0.04		0.06	$V_{REF}$
PG high limit hysteresis accuracy			-0.02		+0.02	$V_{REF}$
PG low limit range <sup>(5)</sup>	$V_{OUT\_PG\_L}$	$V_{OUT}$ falling edge	0.85		0.9	$V_{REF}$
PG low limit accuracy <sup>(6)</sup>			0.86	0.9	0.94	$V_{REF}$
PG low limit hysteresis range <sup>(5)</sup>	$V_{OUT\_PG\_L\_HYS}$		0.04		0.06	$V_{REF}$
PG low limit hysteresis accuracy			-0.02		+0.02	$V_{REF}$
PG output low voltage	$V_{PG\_L}$	$I_{PG\_SINK} = 200\mu A$			0.4	V
PG leakage current	$I_{PG\_LKG}$	$V_{PG} = 5V$			1	$\mu A$
PG flip-flop delay timer	$t_{PG\_DELAY}$	After soft start ends, consecutive switching count when $V_{OUT}$ is in or not in regulation		30		$\mu s$

**Notes:**

- 5) Configurable via the I<sup>2</sup>C interface.
- 6) Not tested in the entire option range. Only guaranteed for the specified option, which is the default values pre-configured in the OTP register.
- 7) Not tested in production. Guaranteed by design and characterization.

## I<sup>2</sup>C INTERFACE ELECTRICAL CHARACTERISTICS

Typical values are at  $V_{IN} = 12V$ ,  $V_{EN} = 2V$ ,  $T_J = 25^\circ C$ . Minimum and maximum values are at  $V_{IN} = 12V$ ,  $V_{EN} = 2V$ ,  $T_J = -40^\circ C$  to  $+150^\circ C$ , guaranteed by characterization. All voltages with respect to ground, unless otherwise noted.

Parameters	Symbol	Condition	Min	Typ	Max	Units
SCL/SDA input logic low	$V_{IL}$		0		0.8	V
SCL/SDA input logic high	$V_{IH}$		1.5			V
SCL/SDA output logic low	$V_{OL}$	$I_{LOAD} = 3mA$			0.4	V
SCL clock frequency	$f_{SCL}$				400	kHz
SCL high time	$t_{HIGH}$		0.6			$\mu s$
SCL low time	$t_{LOW}$		1.3		1.67	$\mu s$
Data set-up time	$t_{SU\_DAT}$		100			ns
Data hold time	$t_{HD\_DAT}$		0.25		0.9	$\mu s$
Set-up time for repeated start	$t_{SU\_STA}$		0.6			$\mu s$
Hold time for start	$t_{HD\_STA}$		0.6			$\mu s$
Bus free time between a start and a stop condition	$t_{BUF}$		1.3			$\mu s$
Set-up time for stop condition	$t_{SU\_STO}$		0.6			$\mu s$
SCL/SDA rise time	$t_R$		$20 + 0.1 \times C_B$		300	ns
SCL/SDA fall time	$t_F$		$20 + 0.1 \times C_B$		300	ns
Pulse width of suppressed spike	$t_{SP}$		0		50	ns
Capacitance bus for each bus line	$C_B$				400	pF

## I<sup>2</sup>C-COMPATIBLE INTERFACE TIMING DIAGRAM

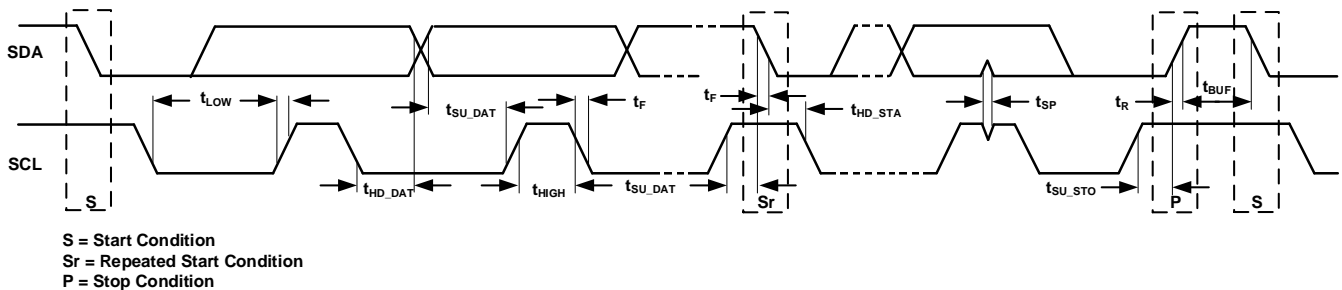

## TYPICAL CHARACTERISTICS

$V_{IN} = 12V$ ,  $T_J = -40^{\circ}C$  to  $+150^{\circ}C$ , unless otherwise noted.

**$V_{IN}$  UVLO Threshold vs. Temperature**  
Normal input mode

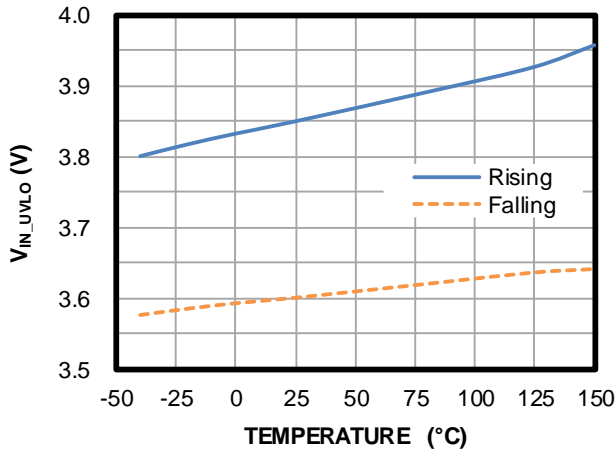

**$V_{IN}$  UVLO Threshold vs. Temperature**  
Low-input mode

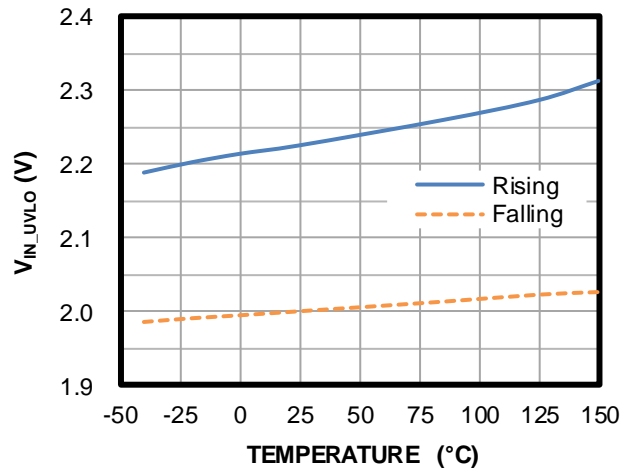

**Shutdown Current vs. Temperature**

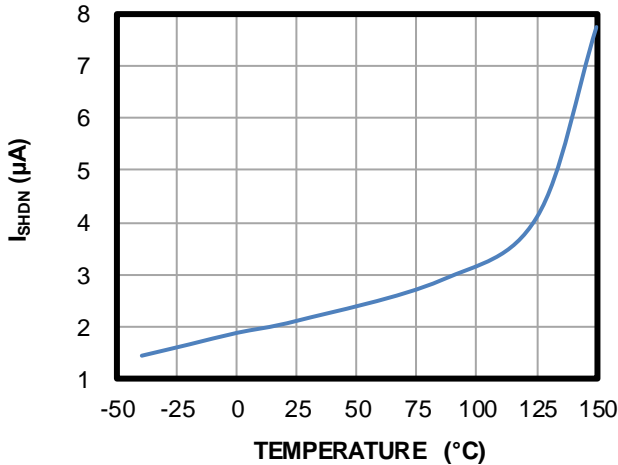

**Quiescent Current vs. Temperature**  
No switching

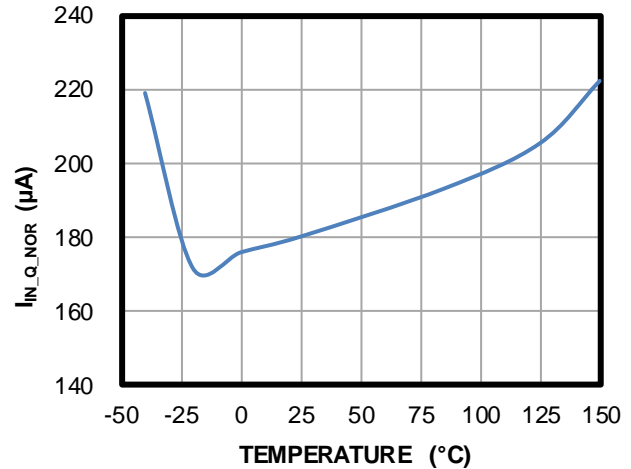

**$V_{CC}$  vs. Temperature**  
 $V_{IN} = 12V$

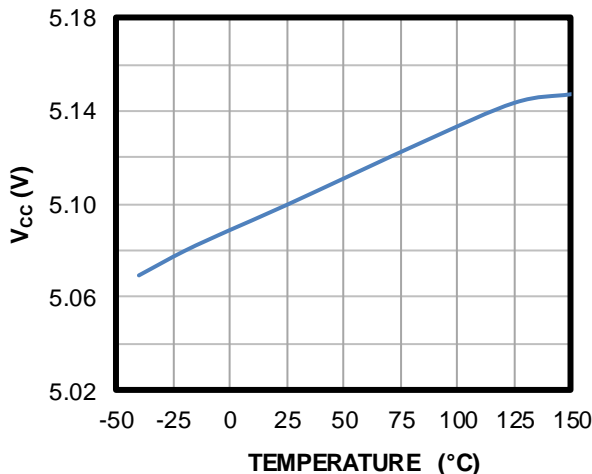

**Switching Frequency vs. Temperature**  
 $f_{sw} = 500kHz$  (Reg 0x03, bits[5:0] = 0Ah)

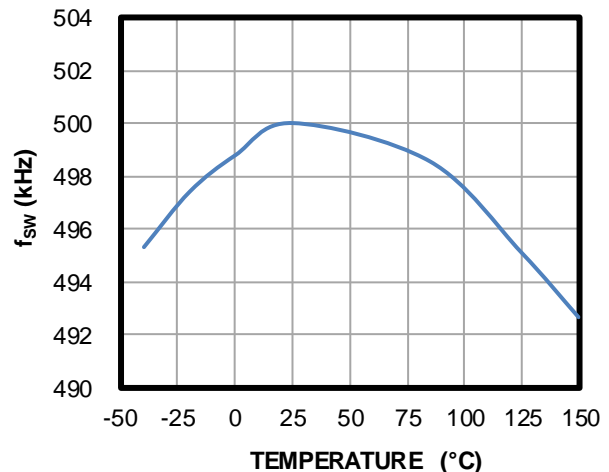

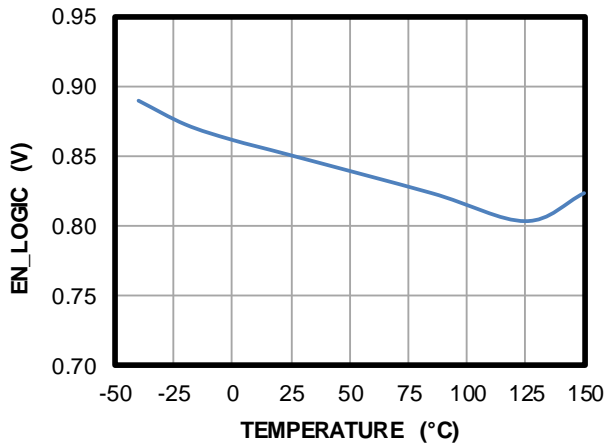
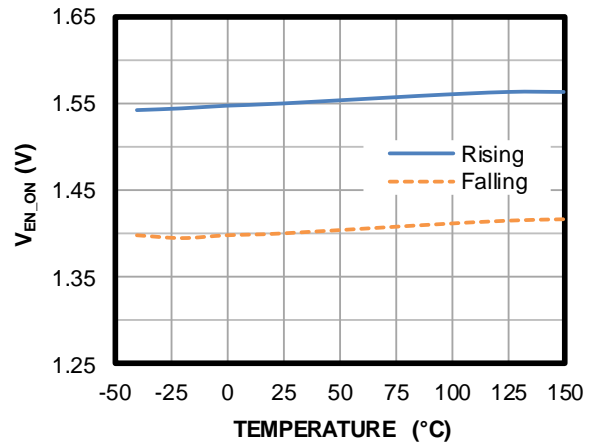
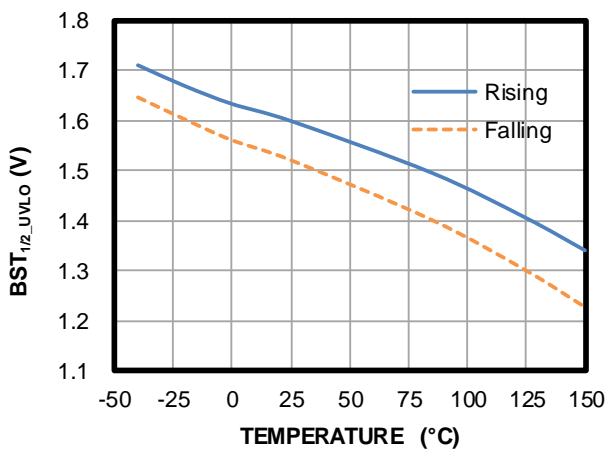
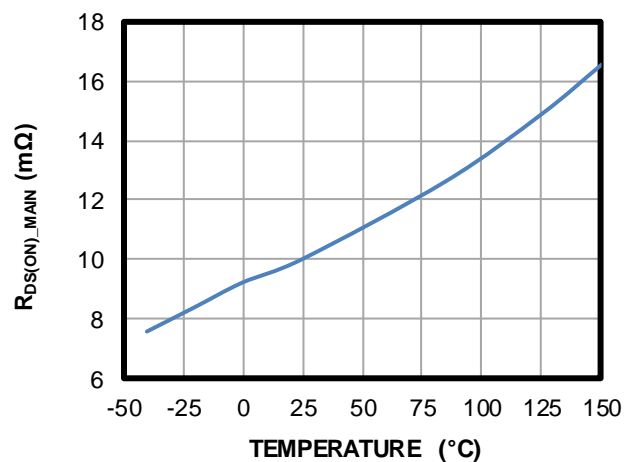
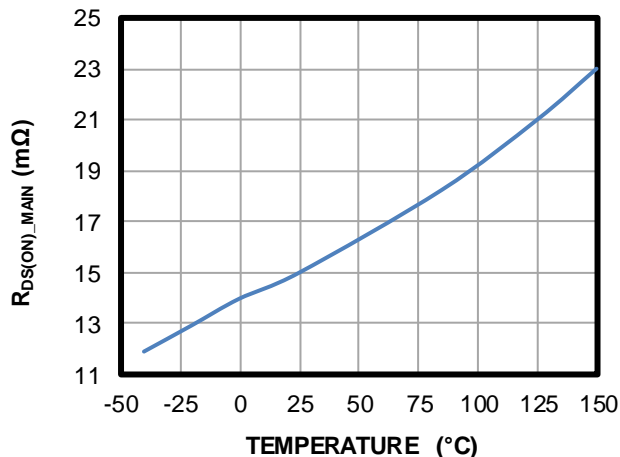
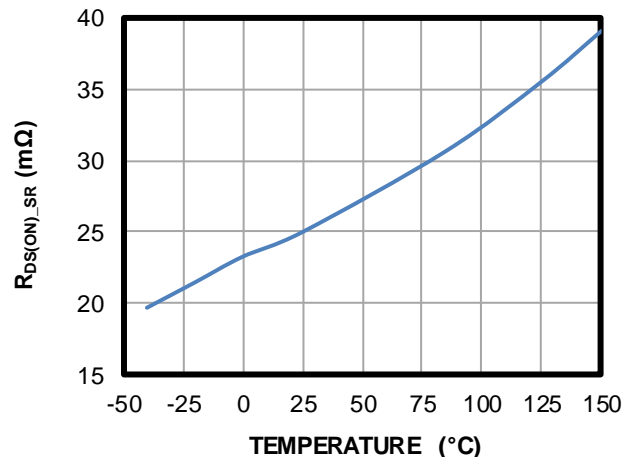

**TYPICAL CHARACTERISTICS (continued)**
 $V_{IN} = 12V$ ,  $T_J = -40^{\circ}C$  to  $+150^{\circ}C$ , unless otherwise noted.

**EN Logic Rising vs. Temperature**

**System EN Threshold vs. Temperature**

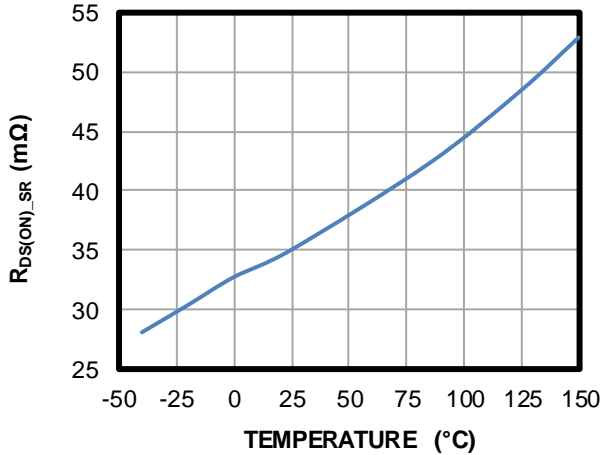
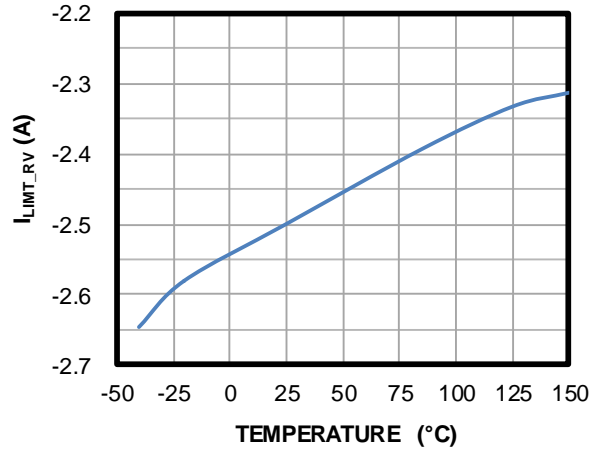
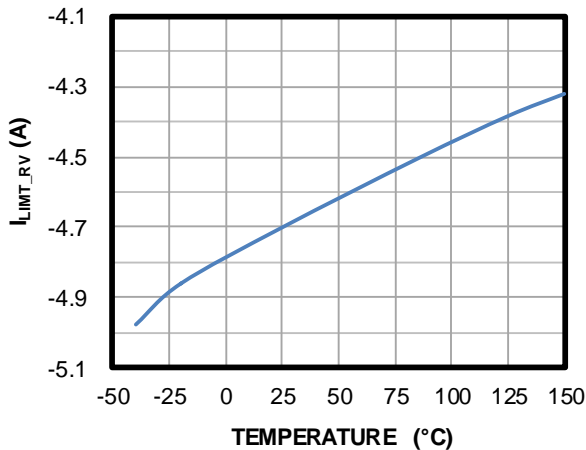
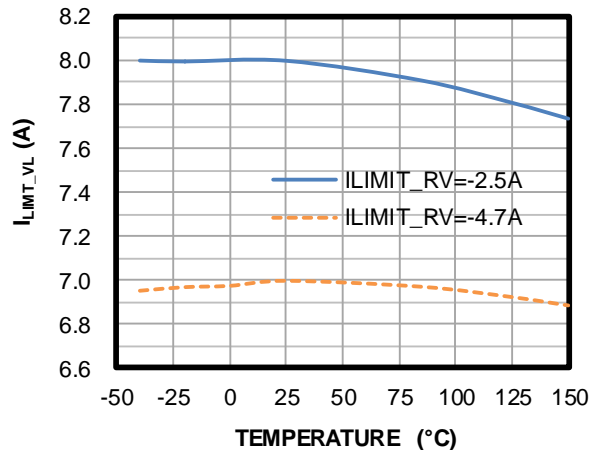
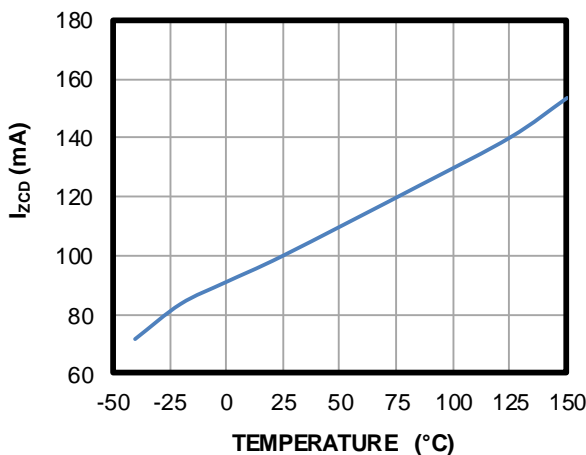
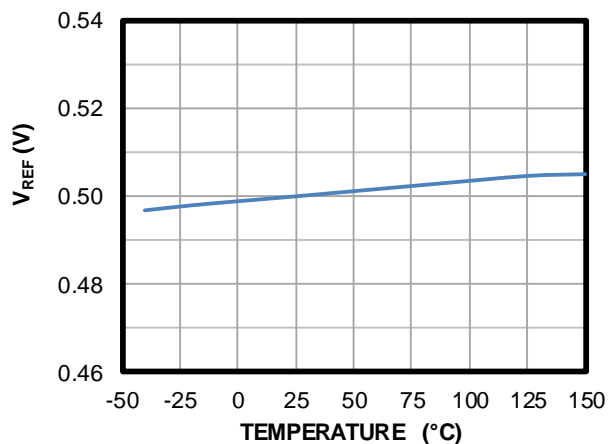
**BST UVLO vs. Temperature**

**Main Switch (Q1/Q3) On Resistance vs. Temperature**
 $V_{CC} = 5V$ 

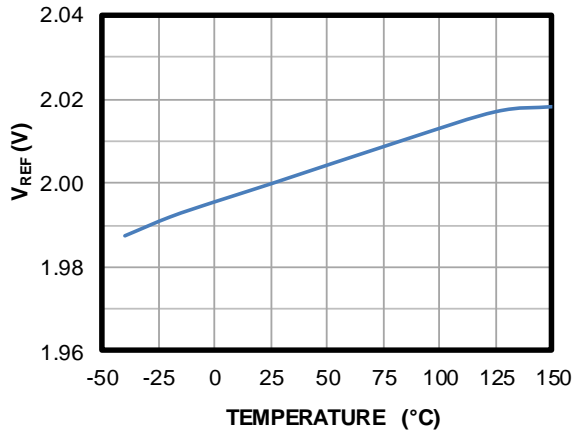
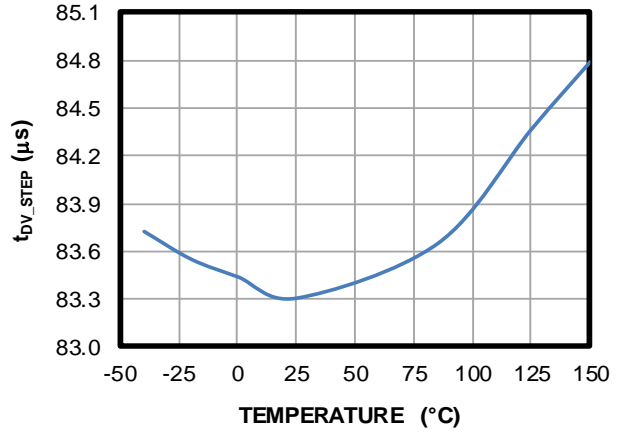
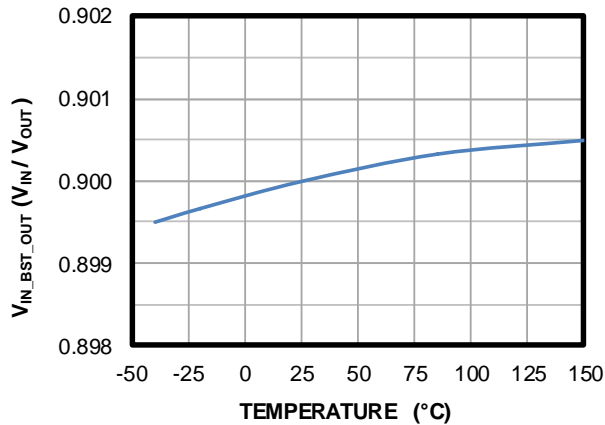
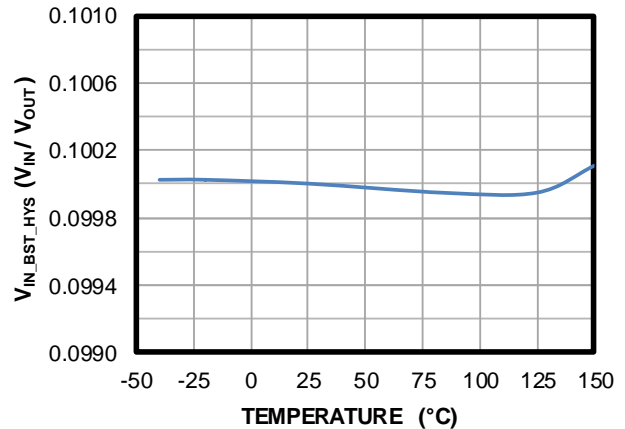
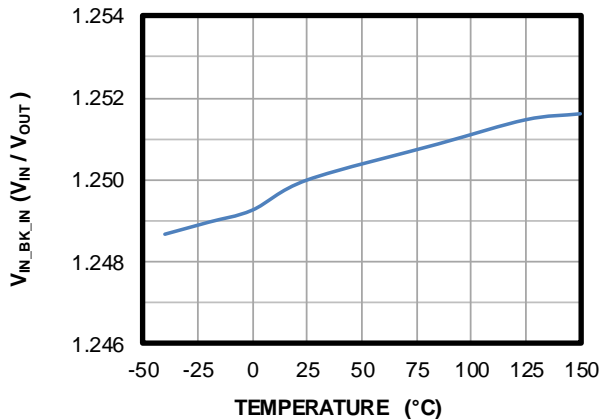
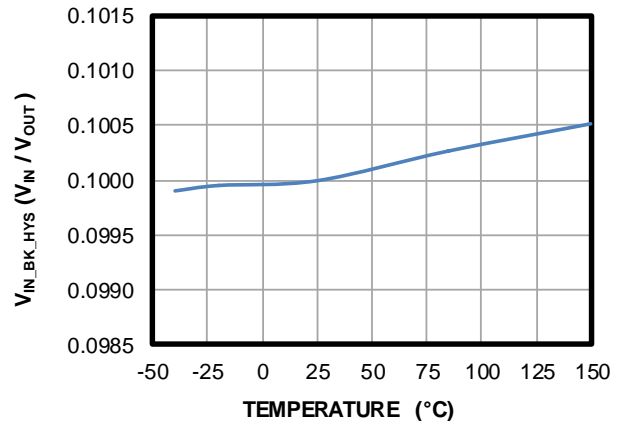
**Main Switch (Q1/Q3) On Resistance vs. Temperature**
 $V_{CC} = 2.55V$ 

**Synchronous Rectifier Switch (Q2/Q4) On Resistance vs. Temp**
 $V_{CC} = 5V$ 

**TYPICAL CHARACTERISTICS (continued)**
 $V_{IN} = 12V$ ,  $T_J = -40^{\circ}C$  to  $+150^{\circ}C$ , unless otherwise noted.

**Synchronous Rectifier Switch (Q2/Q4) On Resistance vs. Temp**  
 $V_{CC} = 2.55V$ 

**Reverse Current Limit vs. Temperature**  
 $I_{LIMIT\_RV} = -2.5A$ 

**Reverse Current Limit vs. Temperature**  
 $I_{LIMIT\_RV} = -4.7A$ 

**Valley Current Limit vs. Temperature**  
 $I_{LIMIT\_VL} = 8A$ 

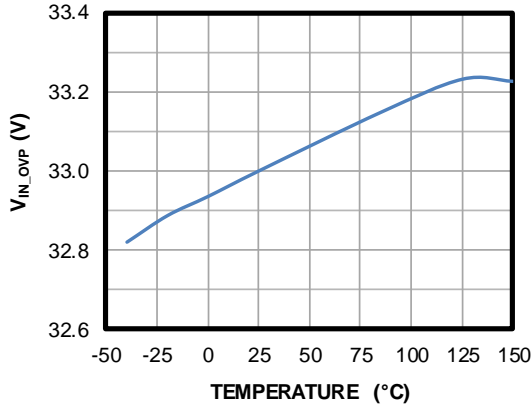
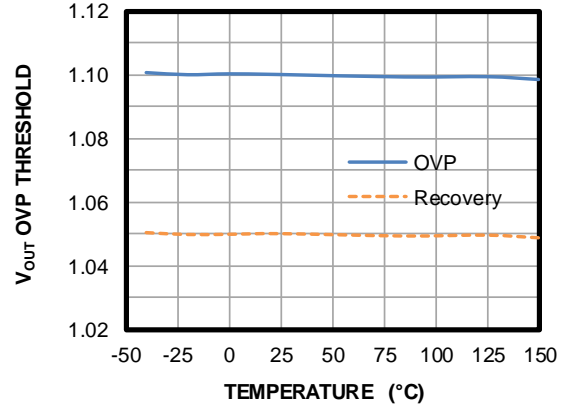
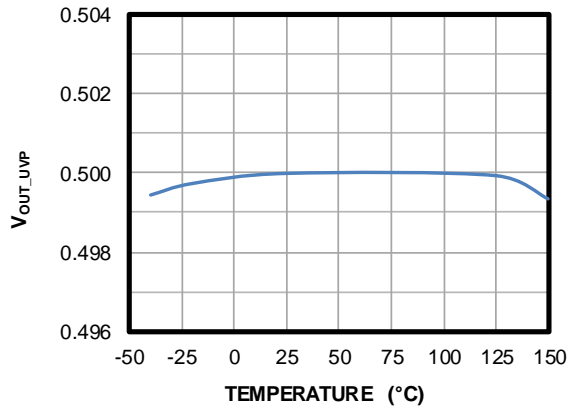
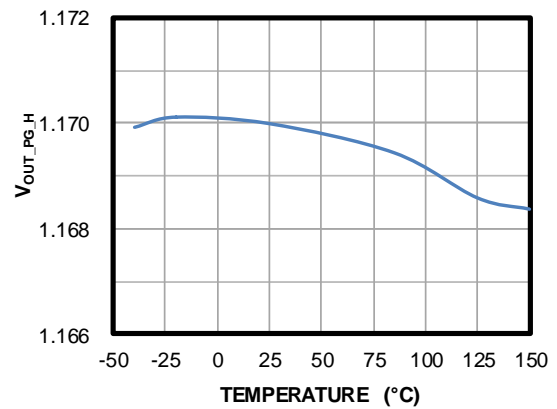
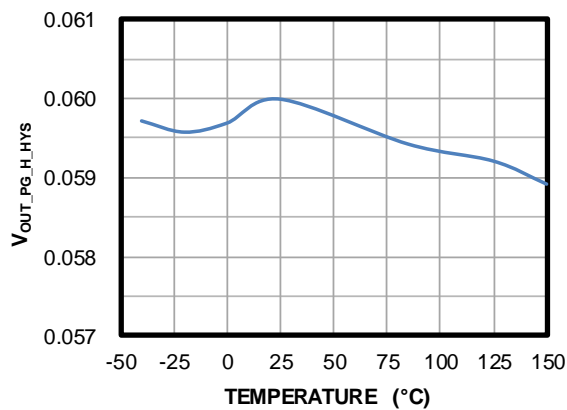
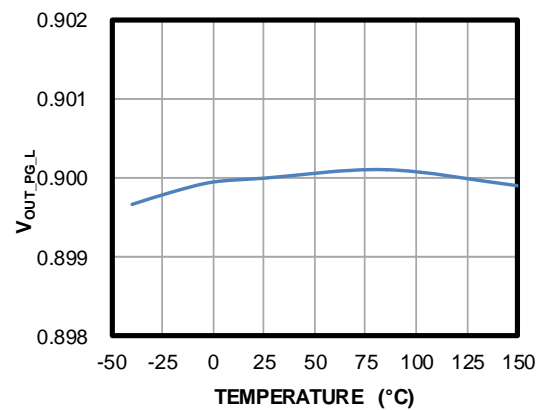
 **$I_{ZCD}$  vs. Temperature**  
 DCM

**Reference Voltage vs. Temperature**  
 $V_{REF} = 0.5V$ 

**TYPICAL CHARACTERISTICS (continued)**
 $V_{IN} = 12V$ ,  $T_J = -40^{\circ}C$  to  $+150^{\circ}C$ , unless otherwise noted.

**Reference Voltage vs. Temperature**
 $V_{REF} = 2V$ 

**Dynamic Adjustment Step Interval vs. Temperature**
 $t_{DV\_STEP} = 83.3\mu s$ 

**Boost Out Threshold vs. Temperature**
 $V_{IN\_BST\_OUT} = 90\%$ ,  $V_{IN\_BST\_HYS} = 7.5\%$ , with respect to  $V_{IN} / V_{OUT}$ 

**Boost Transition Hysteresis vs. Temperature**
 $V_{IN\_BST\_HYS} = 10\%$ , with respect to  $V_{IN} / V_{OUT}$ 

**Buck In Threshold vs. Temperature**
 $V_{IN\_BK\_IN} / V_{OUT} = 125\%$ ,  $V_{IN\_BK\_HYS} / V_{OUT} = 10\%$ , with respect to  $V_{IN} / V_{OUT}$ 

**Buck Transition Hysteresis vs. Temperature**
 $V_{IN\_BK\_HYS} / V_{OUT} = 10\%$ , with respect to  $V_{IN} / V_{OUT}$ 

**TYPICAL CHARACTERISTICS (continued)**
 $V_{IN} = 12V$ ,  $T_J = -40^{\circ}C$  to  $+150^{\circ}C$ , unless otherwise noted.

**Input OVP Threshold vs. Temperature**
 $V_{IN\_OVP} = 33V$ 

**Output OVP Threshold vs. Temperature**
 $V_{OUT\_OVP} = 1.1$ ,  $V_{OUT\_OVP\_REC} = 1.05$ 

**Output UVP Threshold vs. Temperature**
 $V_{OUT\_UVP} = 0.5$ 

**PG High Limit Threshold vs. Temperature**
 $V_{OUT\_PG\_H} = 1.17$ 

**PG High Limit Hysteresis vs. Temperature**
 $V_{OUT\_PG\_H\_HYS} = 0.06$ 

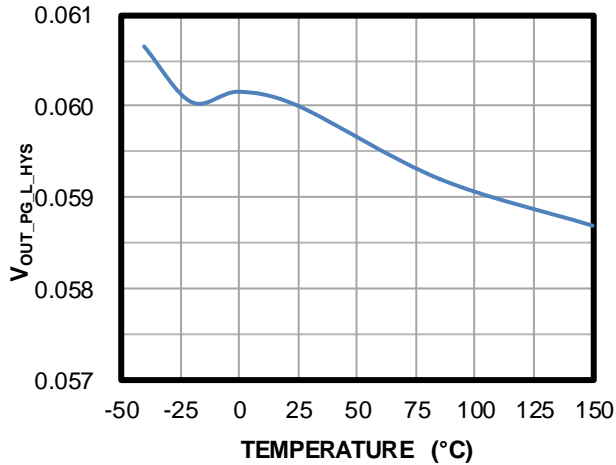
**PG Low Limit Threshold vs. Temperature**
 $V_{OUT\_PG\_L} = 0.9$ 

## TYPICAL CHARACTERISTICS *(continued)*

V<sub>IN</sub> = 12V, T<sub>J</sub> = -40°C to +150°C, unless otherwise noted.

### PG Low Limit Hysteresis vs. Temperature

V<sub>OUT\_PG\_L\_HYS</sub> = 0.06



## TYPICAL PERFORMANCE CHARACTERISTICS

$V_{IN} = 13.5V$ ,  $V_{OUT} = 11.5V$ ,  $L = 10\mu H$ ,  $C_{OUT} = 40\mu F$ ,  $f_{SW} = 450kHz$ , FCCM,  $T_A = 25^\circ C$ , unless otherwise noted.

### Efficiency vs. Load Current

$V_{OUT} = 11.5V$ , FCCM,  $I_{OUT} = 10mA$  to 1A

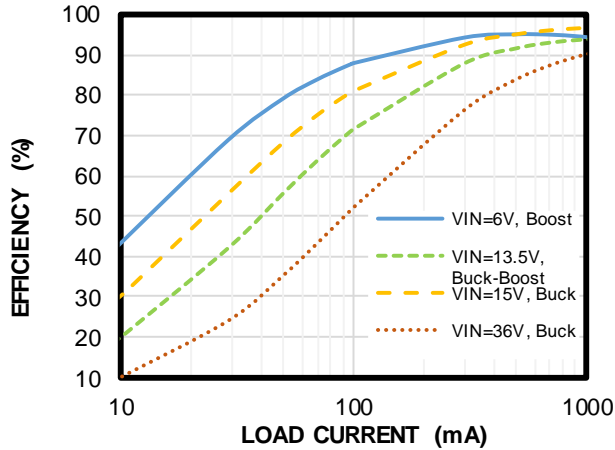

### Efficiency vs. Load Current

$V_{OUT} = 11.5V$ , FCCM,  $I_{OUT} = 0.5A$  to 5A

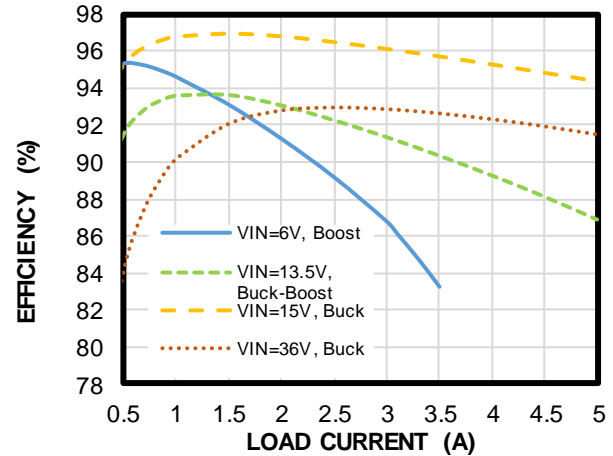

### Efficiency vs. Load Current

$V_{OUT} = 11.5V$ , DCM,  $I_{OUT} = 10mA$  to 1A

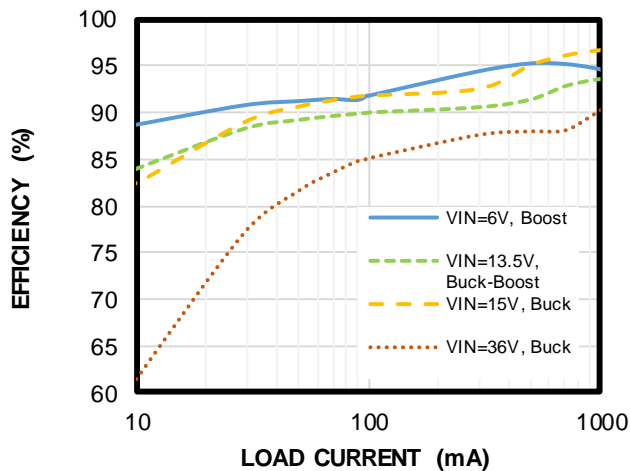

### Efficiency vs. Load Current

$V_{OUT} = 11.5V$ , DCM,  $I_{OUT} = 0.5A$  to 5A

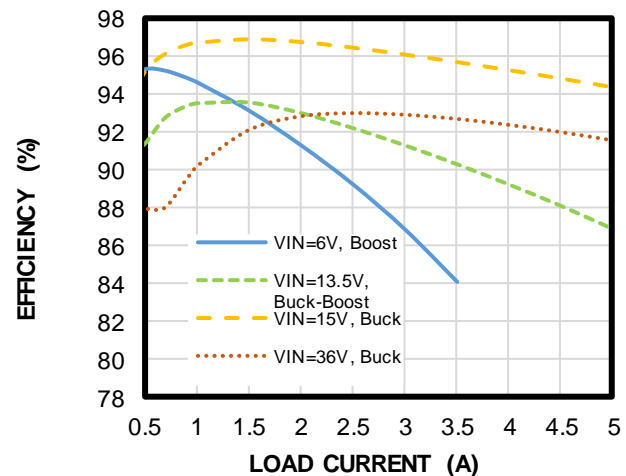

### Efficiency vs. Load Current

$V_{OUT} = 9V$ , FCCM,  $I_{OUT} = 10mA$  to 1A

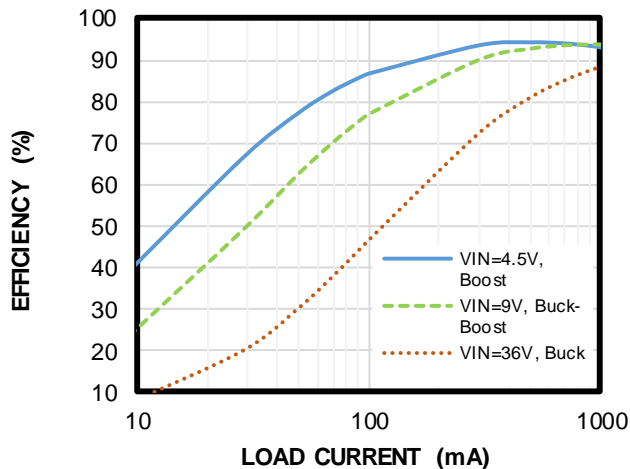

### Efficiency vs. Load Current

$V_{OUT} = 9V$ , FCCM,  $I_{OUT} = 0.5A$  to 5A

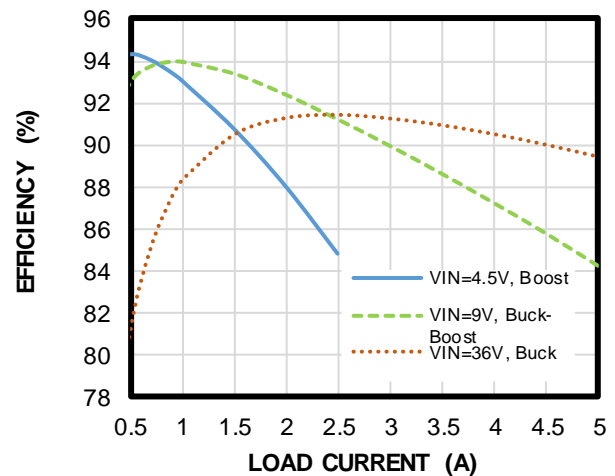

## TYPICAL PERFORMANCE CHARACTERISTICS (continued)

$V_{IN} = 13.5V$ ,  $V_{OUT} = 11.5V$ ,  $L = 10\mu H$ ,  $C_{OUT} = 40\mu F$ ,  $f_{SW} = 450kHz$ , FCCM,  $T_A = 25^\circ C$ , unless otherwise noted.

### Efficiency vs. Load Current

$V_{OUT} = 9V$ , DCM,  $I_{OUT} = 10mA$  to 1A

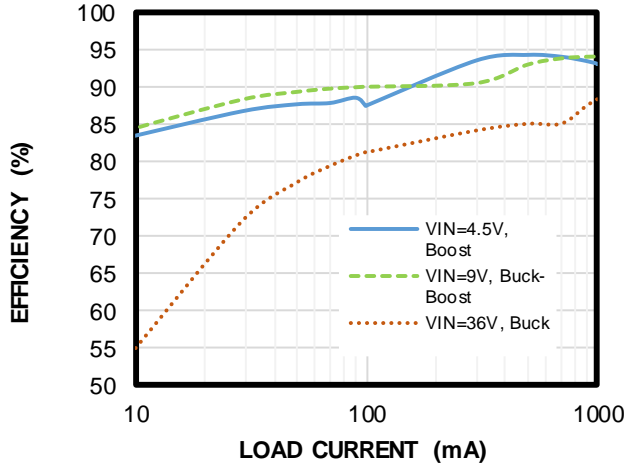

### Efficiency vs. Load Current

$V_{OUT} = 9V$ , DCM,  $I_{OUT} = 0.5A$  to 5A

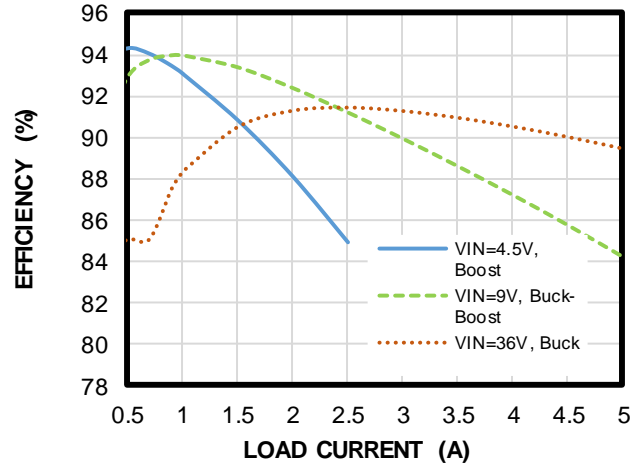

### Efficiency vs. Load Current

$V_{OUT} = 5V$ , FCCM,  $I_{OUT} = 10mA$  to 1A

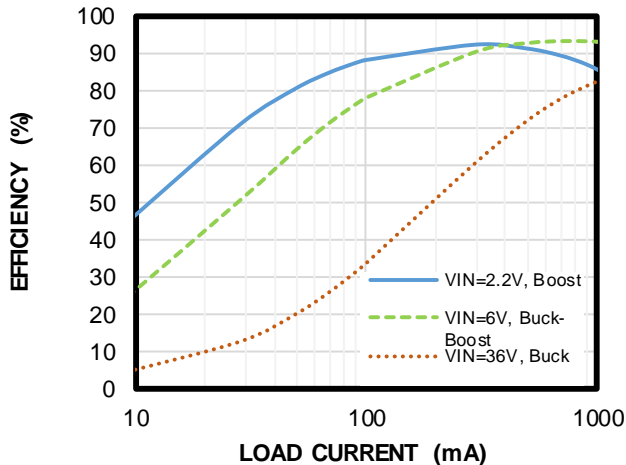

### Efficiency vs. Load Current

$V_{OUT} = 5V$ , FCCM,  $I_{OUT} = 0.5A$  to 5A

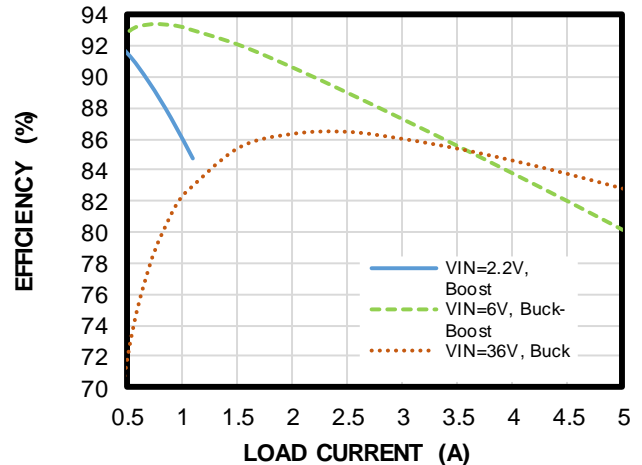

### Efficiency vs. Load Current

$V_{OUT} = 5V$ , DCM,  $I_{OUT} = 10mA$  to 1A

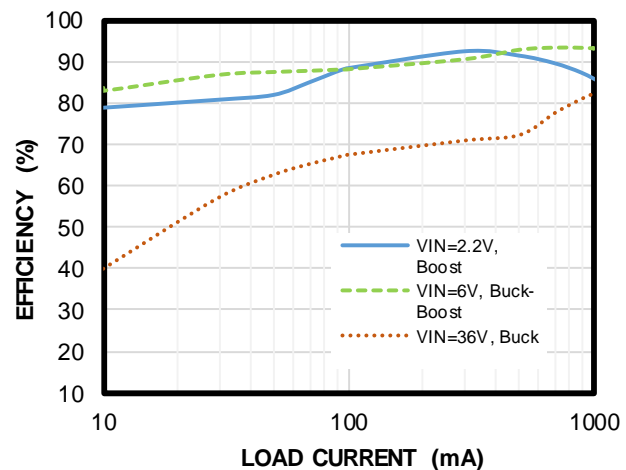

### Efficiency vs. Load Current

$V_{OUT} = 5V$ , DCM,  $I_{OUT} = 0.5A$  to 5A

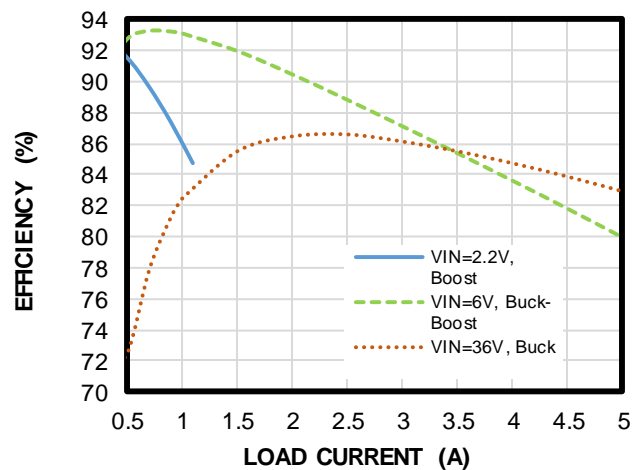



## TYPICAL PERFORMANCE CHARACTERISTICS *(continued)*

$V_{IN} = 13.5V$ ,  $V_{OUT} = 11.5V$ ,  $L = 10\mu H$ ,  $C_{OUT} = 40\mu F$ ,  $f_{SW} = 450kHz$ , FCCM,  $T_A = 25^\circ C$ , unless otherwise noted.

### Load Regulation

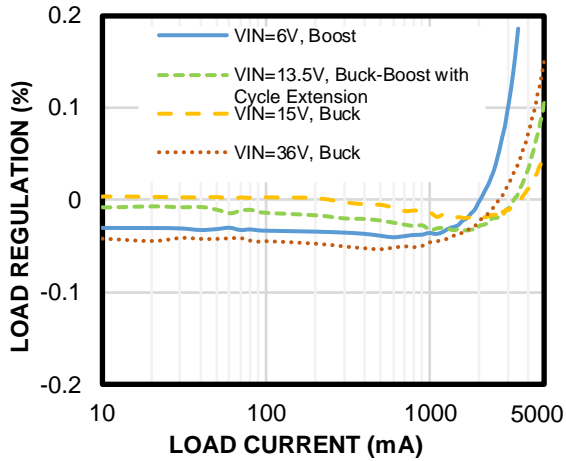

### Line Regulation

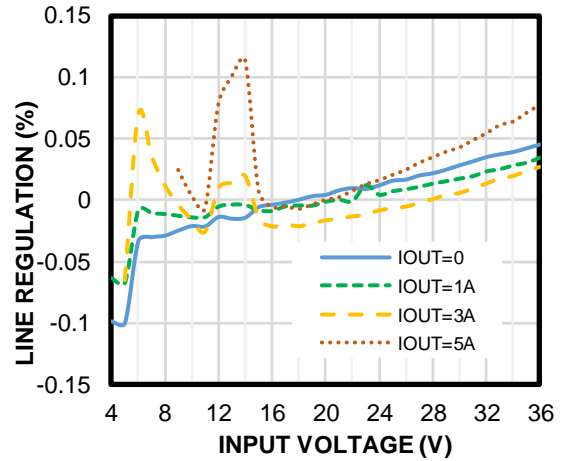

### Case Temperature Rise vs. Load Current

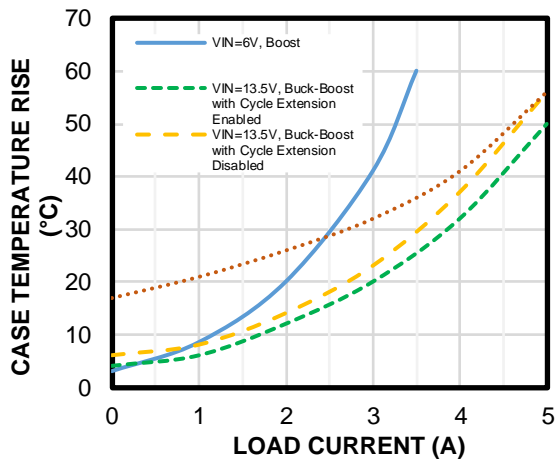

## TYPICAL PERFORMANCE CHARACTERISTICS (continued)

$V_{IN} = 13.5V$ ,  $V_{OUT} = 11.5V$ ,  $L = 10\mu H$ ,  $C_{OUT} = 40\mu F$ ,  $f_{SW} = 450kHz$ , FCCM,  $T_A = 25^\circ C$ , unless otherwise noted.

### Steady State

$V_{IN} = 6V$ ,  $I_{OUT} = 0A$ , boost mode

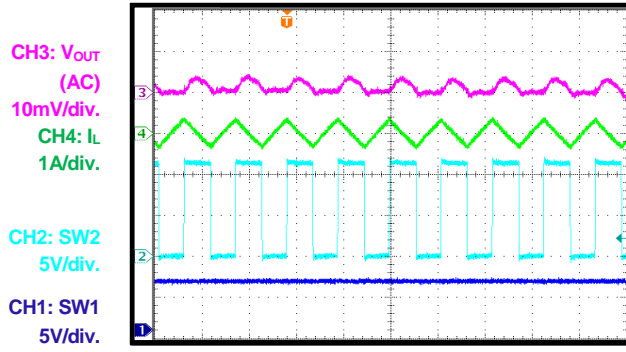

2 $\mu s$ /div.

### Steady State

$V_{IN} = 6V$ ,  $I_{OUT} = 3.5A$ , boost mode

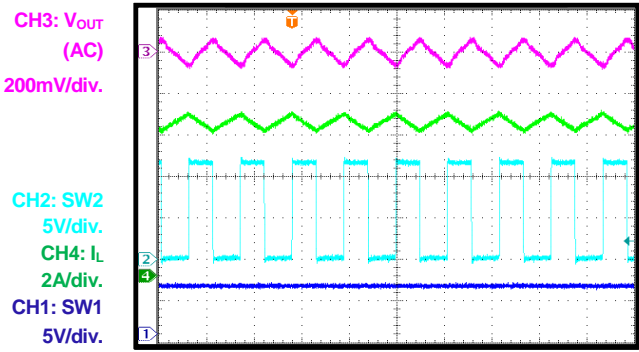

2 $\mu s$ /div.

### Steady State

$V_{IN} = 13.5V$ ,  $I_{OUT} = 0A$ , buck-boost mode

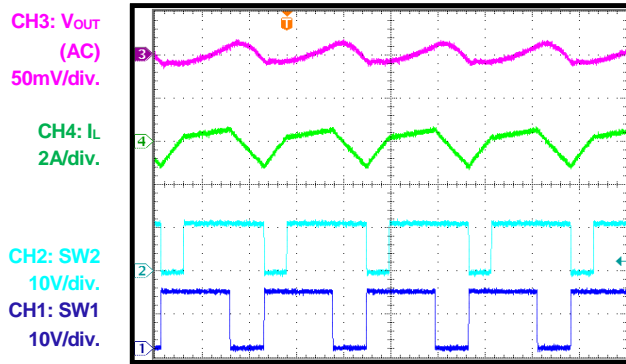

2 $\mu s$ /div.

### Steady State

$V_{IN} = 13.5V$ ,  $I_{OUT} = 5A$ , buck-boost mode

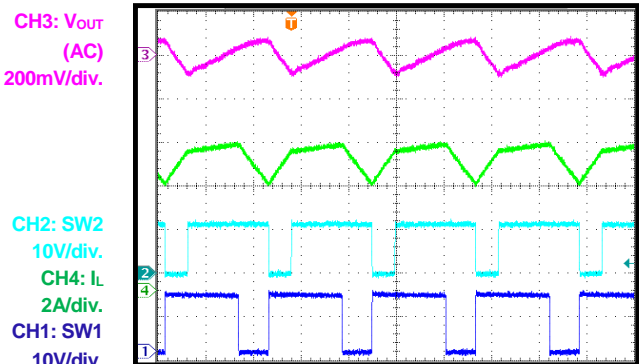

2 $\mu s$ /div.

### Steady State

$V_{IN} = 15V$ ,  $I_{OUT} = 0A$ , buck mode

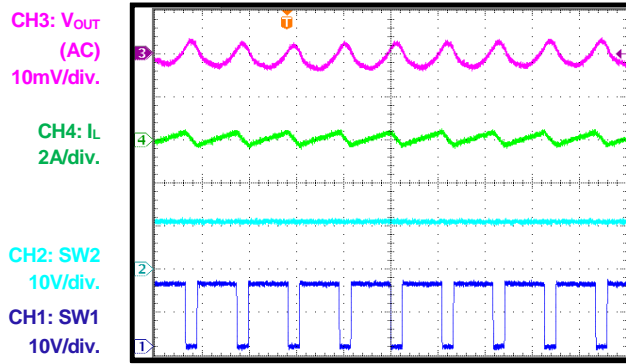

2 $\mu s$ /div.

### Steady State

$V_{IN} = 15V$ ,  $I_{OUT} = 5A$ , buck mode

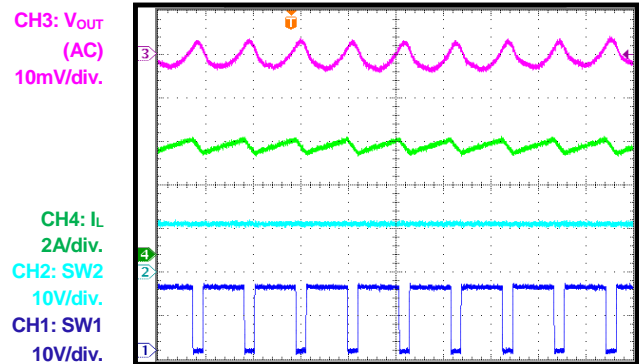

2 $\mu s$ /div.

## TYPICAL PERFORMANCE CHARACTERISTICS (continued)

$V_{IN} = 13.5V$ ,  $V_{OUT} = 11.5V$ ,  $L = 10\mu H$ ,  $C_{OUT} = 40\mu F$ ,  $f_{SW} = 450kHz$ , FCCM,  $T_A = 25^\circ C$ , unless otherwise noted.

### Start-Up through Input Voltage

$I_{OUT} = 0A$

CH3:  $V_{IN}$   
10V/div.  
 $V_{OUT}$   
5V/div.  
CH4:  $I_L$   
2A/div.  
CH2: SW2  
10V/div.  
CH1: SW1  
10V/div.

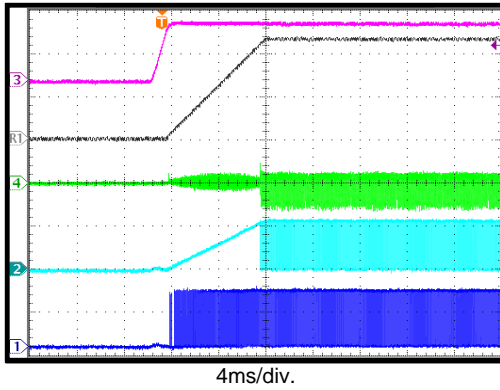

### Start-Up through Input Voltage

$I_{OUT} = 5A$

CH3:  $V_{IN}$   
10V/div.  
 $V_{OUT}$   
5V/div.  
CH4:  $I_L$   
5A/div.  
CH2: SW2  
10V/div.  
CH1: SW1  
10V/div.

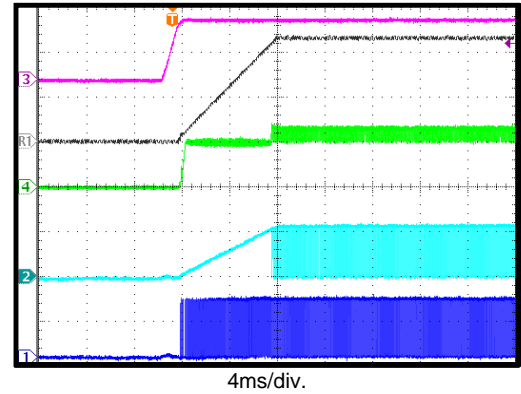

### Shutdown through Input Voltage

$I_{OUT} = 0A$

CH3:  $V_{IN}$   
10V/div.  
 $V_{OUT}$   
5V/div.  
CH4:  $I_L$   
2A/div.  
CH2: SW2  
10V/div.  
CH1: SW1  
10V/div.

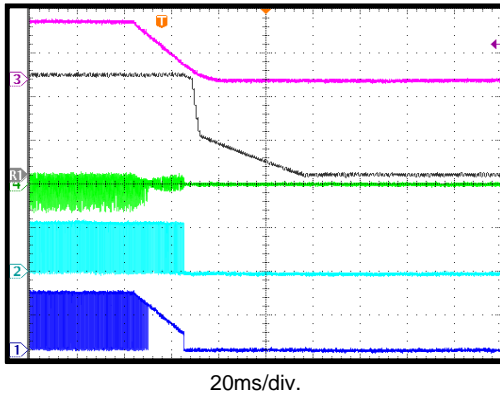

### Shutdown through Input Voltage

$I_{OUT} = 5A$

CH3:  $V_{IN}$   
10V/div.  
 $V_{OUT}$   
5V/div.  
CH4:  $I_L$   
5A/div.  
CH2: SW2  
10V/div.  
CH1: SW1  
10V/div.

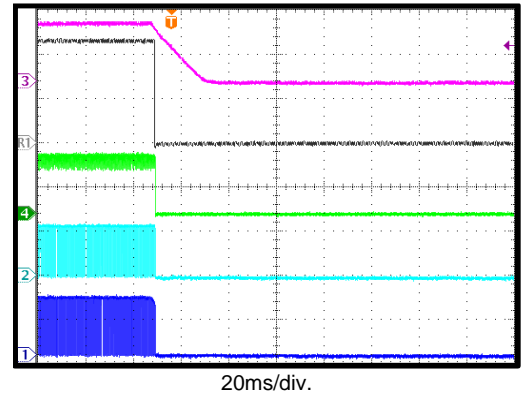

### Start-Up through EN

$I_{OUT} = 0A$

CH3: EN  
2V/div.  
 $V_{OUT}$   
5V/div.  
CH4:  $I_L$   
2A/div.  
CH2: SW2  
10V/div.  
CH1: SW1  
10V/div.

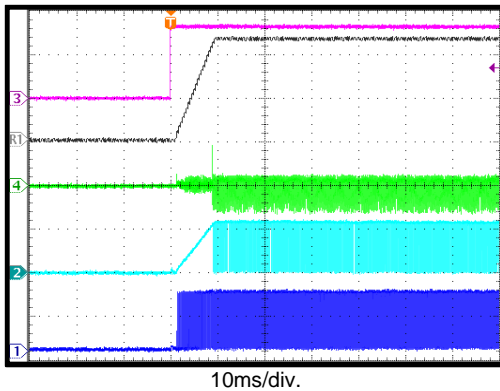

### Start-Up through EN

$I_{OUT} = 5A$

CH3: EN  
2V/div.  
 $V_{OUT}$   
5V/div.  
CH4:  $I_L$   
5A/div.  
CH2: SW2  
10V/div.  
CH1: SW1  
10V/div.

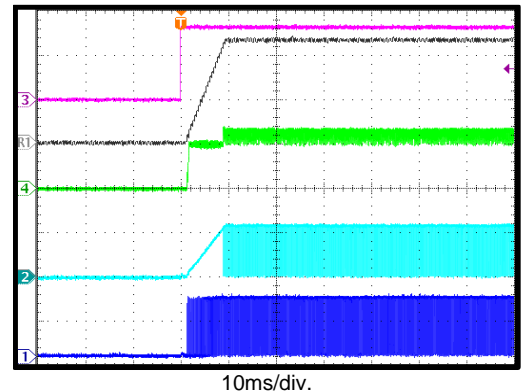

## TYPICAL PERFORMANCE CHARACTERISTICS (continued)

$V_{IN} = 13.5V$ ,  $V_{OUT} = 11.5V$ ,  $L = 10\mu H$ ,  $C_{OUT} = 40\mu F$ ,  $f_{SW} = 450kHz$ , FCCM,  $T_A = 25^\circ C$ , unless otherwise noted.

### Shutdown through EN

$I_{OUT} = 0A$

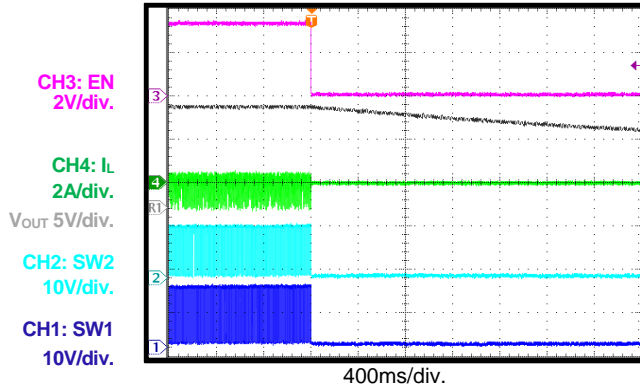

### Shutdown through EN

$I_{OUT} = 5A$

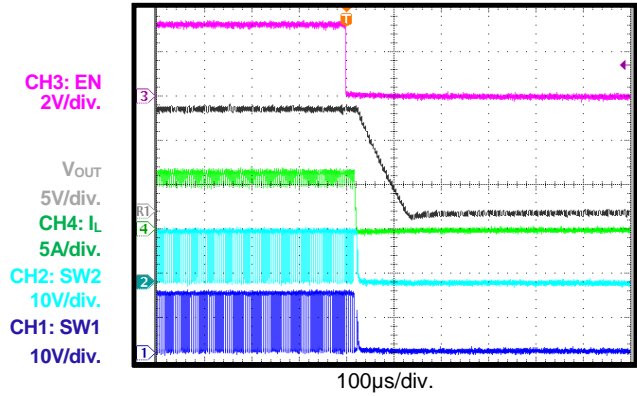

### SCP Steady State

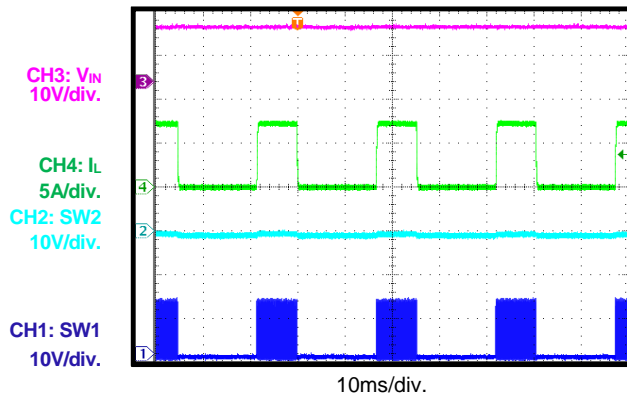

### SCP Entry

$I_{OUT} = 0$  to short circuit

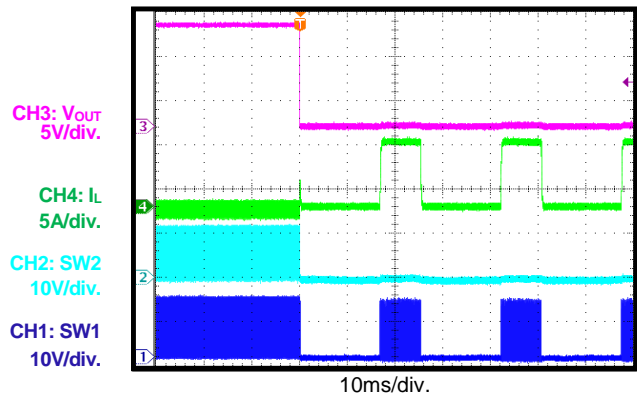

### SCP Entry

$I_{OUT} = 5A$  to short circuit

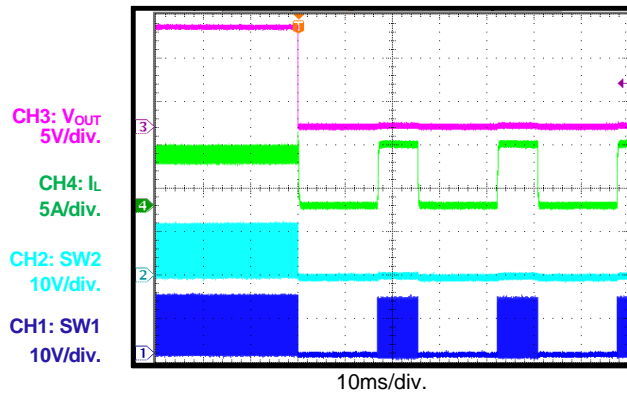

### SCP Recovery

Short circuit to  $I_{OUT} = 0$

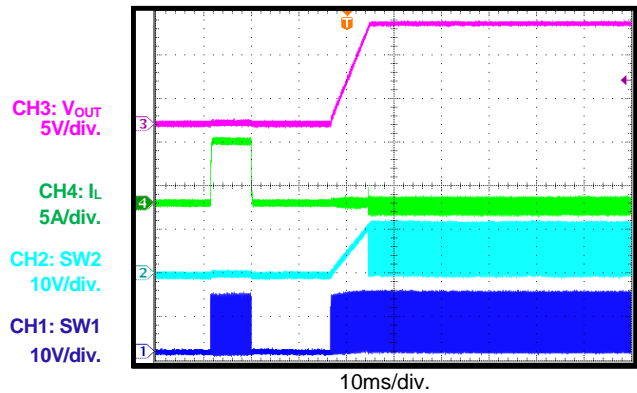

**TYPICAL PERFORMANCE CHARACTERISTICS (continued)**

$V_{IN} = 13.5V$ ,  $V_{OUT} = 11.5V$ ,  $L = 10\mu H$ ,  $C_{OUT} = 40\mu F$ ,  $f_{SW} = 450kHz$ , FCCM,  $T_A = 25^\circ C$ , unless otherwise noted.

**SCP Recovery**

Short circuit to  $I_{OUT} = 5A$

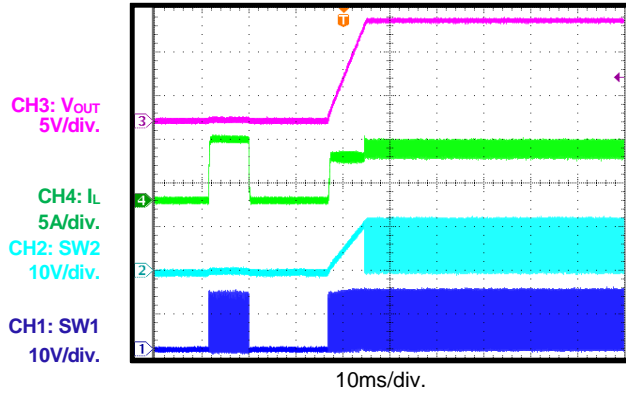
**Load Transient**

$I_{OUT} = 2.5A$  to  $5A$ ,  $1.6A/\mu s$

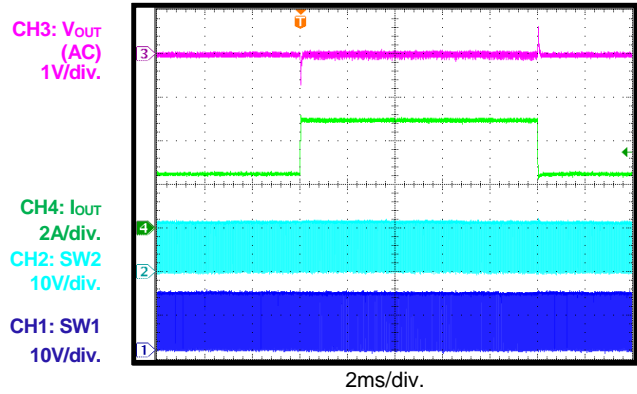
**Load Transient**

$I_{OUT} = 0A$  to  $2.5A$ ,  $1.6A/\mu s$

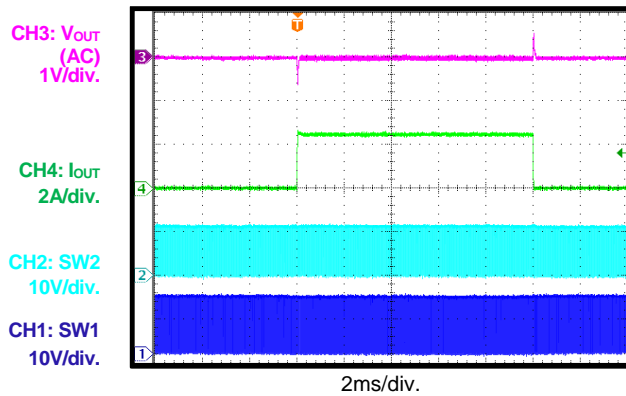
**Load Transient**

$I_{OUT} = 0A$  to  $5A$ ,  $1.6A/\mu s$

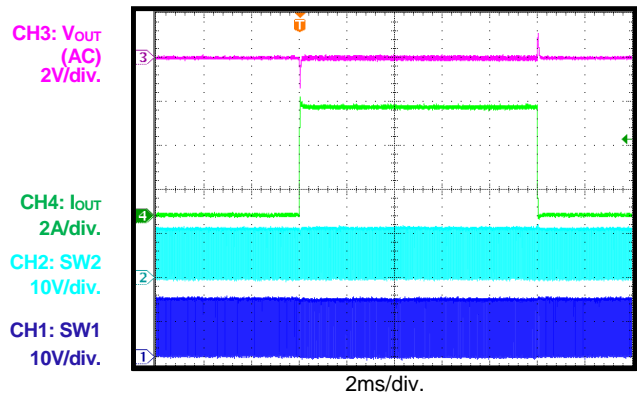
**Mode Transient between Boost and Buck-Boost**

$V_{IN} = 10V$  to  $12V$  to  $10V$ ,  $I_{OUT} = 0$

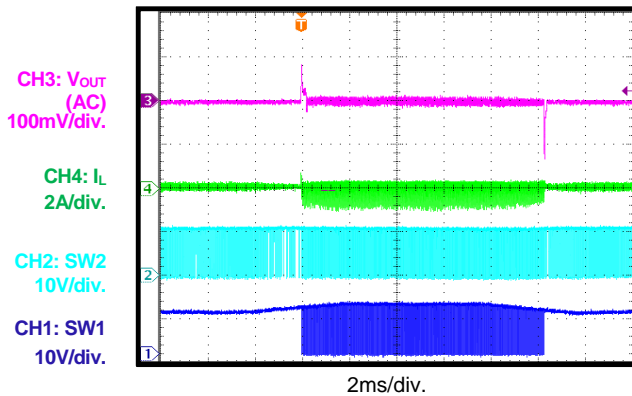
**Mode Transient between Boost and Buck-Boost**

$V_{IN} = 10V$  to  $12V$  to  $10V$ ,  $I_{OUT} = 5A$

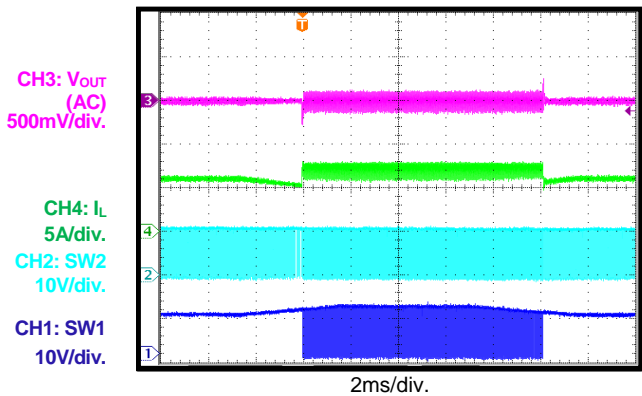

## TYPICAL PERFORMANCE CHARACTERISTICS (continued)

$V_{IN} = 13.5V$ ,  $V_{OUT} = 11.5V$ ,  $L = 10\mu H$ ,  $C_{OUT} = 40\mu F$ ,  $f_{SW} = 450kHz$ , FCCM,  $T_A = 25^\circ C$ , unless otherwise noted.

### Mode Transient between Boost and Buck-Boost

$V_{IN} = 10V$  to  $12V$  to  $10V$ ,  $I_{OUT} = 3A$

CH3:  $V_{OUT}$  (AC)  
100mV/div.

CH4:  $I_L$   
2A/div.  
CH2: SW2  
10V/div.

CH1: SW1  
10V/div.

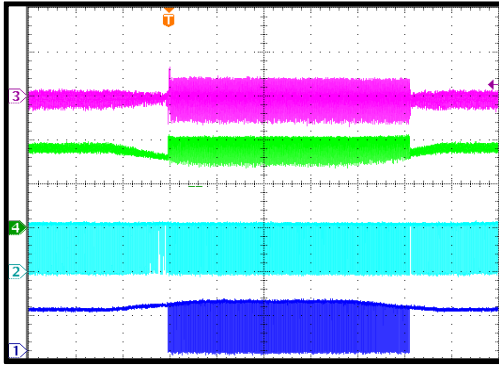

2ms/div.

### Mode Transient between Buck and Buck-Boost

$V_{IN} = 13.5V$  to  $15V$  to  $13.5V$ ,  $I_{OUT} = 0$

CH3:  $V_{OUT}$  (AC)  
200mV/div.

CH4:  $I_L$   
2A/div.

CH2: SW2  
10V/div.

CH1: SW1  
10V/div.

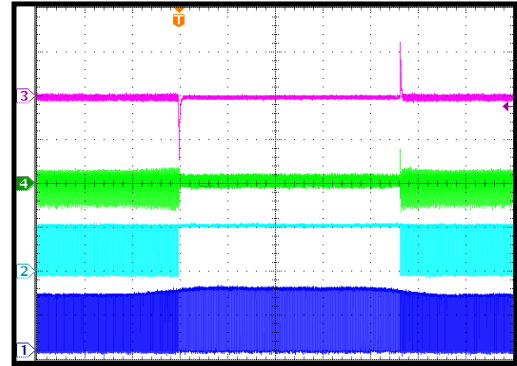

2ms/div.

### Mode Transient between Buck and Buck-Boost

$V_{IN} = 13.5V$  to  $15V$  to  $13.5V$ ,  $I_{OUT} = 5A$

CH3:  $V_{OUT}$  (AC)  
500mV/div.

CH4:  $I_L$   
5A/div.  
CH2: SW2  
10V/div.

CH1: SW1  
10V/div.

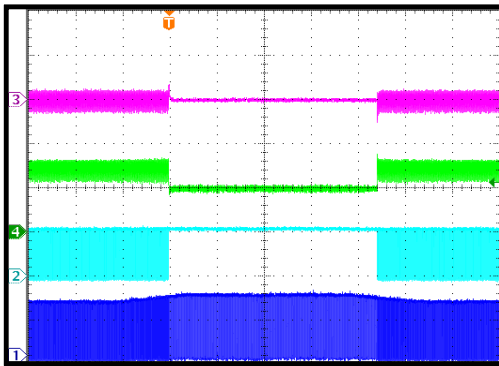

2ms/div.

### Load Dump

$I_{OUT} = 0$

CH3:  $V_{IN}$   
10V/div.

CH4:  $I_L$   
2A/div.

R1:  $V_{OUT}$   
5V/div.  
CH2: SW2  
10V/div.

CH1: SW1  
10V/div.

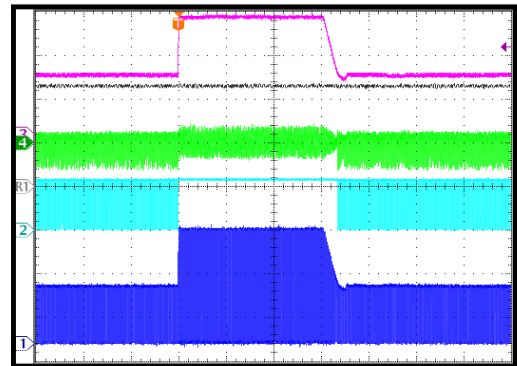

100ms/div.

### Load Dump

$I_{OUT} = 5A$

CH3:  $V_{IN}$   
10V/div.

CH4:  $I_L$   
5A/div.

R1:  $V_{OUT}$   
5V/div.  
CH2: SW2  
10V/div.

CH1: SW1  
10V/div.

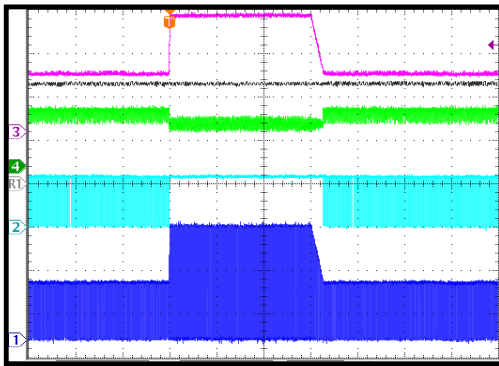

100ms/div.

### $V_{IN}$ Ramp Down and Up

$I_{OUT} = 0$

CH3:  $V_{IN}$   
10V/div.

R1:  $V_{OUT}$   
10V/div.

CH4:  $I_L$   
1A/div.

CH2: SW2  
10V/div.

CH1: SW1  
10V/div.

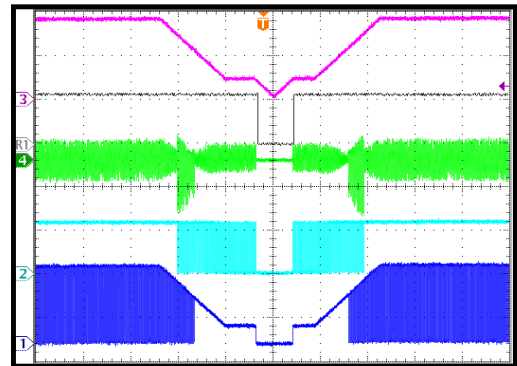

10s/div.

## TYPICAL PERFORMANCE CHARACTERISTICS (continued)

$V_{IN} = 13.5V$ ,  $V_{OUT} = 11.5V$ ,  $L = 10\mu H$ ,  $C_{OUT} = 40\mu F$ ,  $f_{SW} = 450kHz$ , FCCM,  $T_A = 25^\circ C$ , unless otherwise noted.

### $V_{IN}$ Ramp Down and Up

$I_{OUT} = 1A$

CH3:  $V_{IN}$   
10V/div.  
R1:  $V_{OUT}$   
10V/div.  
CH4:  $I_L$   
5A/div.  
CH2: SW2  
10V/div.  
CH1: SW1  
10V/div.

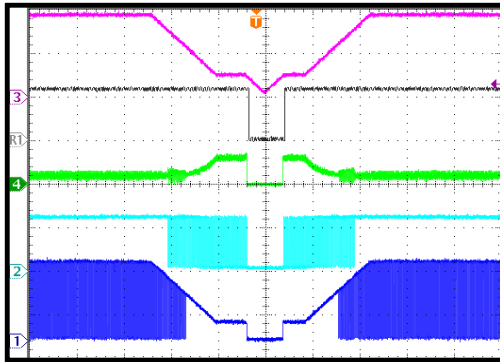

10s/div.

### Reset Behavior

$I_{OUT} = 0$

CH3:  $V_{IN}$   
5V/div.  
CH4:  $I_L$   
1A/div.  
R1:  $V_{OUT}$   
5V/div.  
CH2: SW2  
10V/div.  
CH1: SW1  
5V/div.

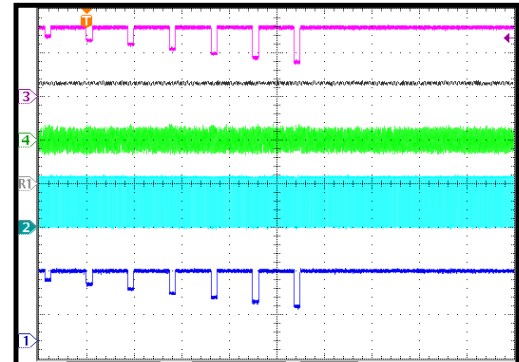

4s/div.

### Reset Behavior

$I_{OUT} = 1A$

CH3:  $V_{IN}$   
5V/div.  
CH4:  $I_L$   
2A/div.  
R1:  $V_{OUT}$   
5V/div.  
CH2: SW2  
10V/div.  
CH1: SW1  
5V/div.

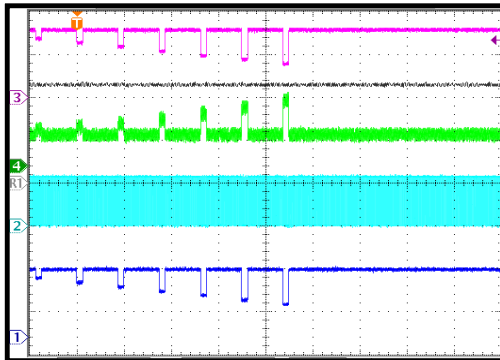

4s/div.

### Cold Crank

$I_{OUT} = 0$

CH3:  $V_{IN}$   
5V/div.  
CH4:  $I_L$   
1A/div.  
R1:  $V_{OUT}$   
5V/div.  
CH2: SW2  
10V/div.  
CH1: SW1  
10V/div.

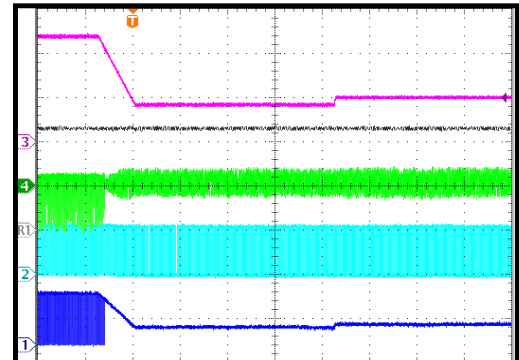

20ms/div.

### Cold Crank

$I_{OUT} = 1A$

CH3:  $V_{IN}$   
5V/div.  
CH4:  $I_L$   
5A/div.  
R1:  $V_{OUT}$   
5V/div.  
CH2: SW2  
10V/div.  
CH1: SW1  
10V/div.

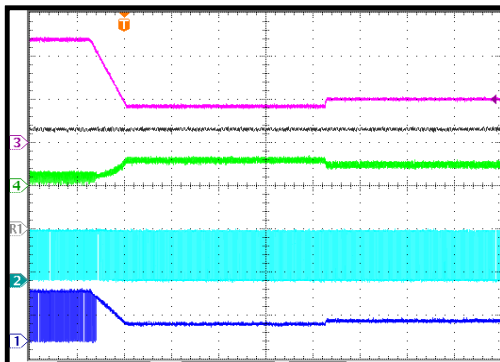

20ms/div.



## TYPICAL PERFORMANCE CHARACTERISTICS (continued)

V<sub>IN</sub> = 12V, V<sub>OUT</sub> = 11.5V, I<sub>OUT</sub> = 5A, L = 10μH, f<sub>SW</sub> = 450kHz, in buck-boost mode, with EMI filters and FSS enabled, T<sub>A</sub> = 25°C, unless otherwise noted. (8)

**CISPR25 Class 5 Peak Conducted Emissions**  
150kHz to 108MHz

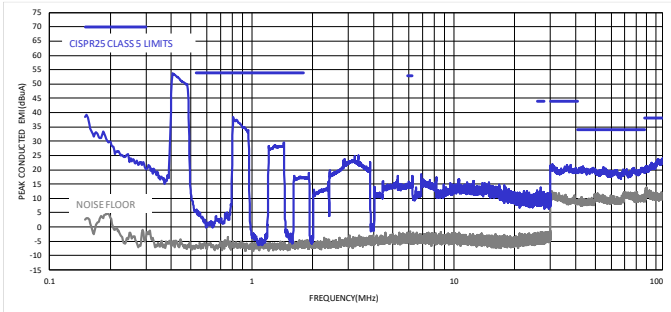

**CISPR25 Class 5 Average Conducted Emissions**  
150kHz to 108MHz

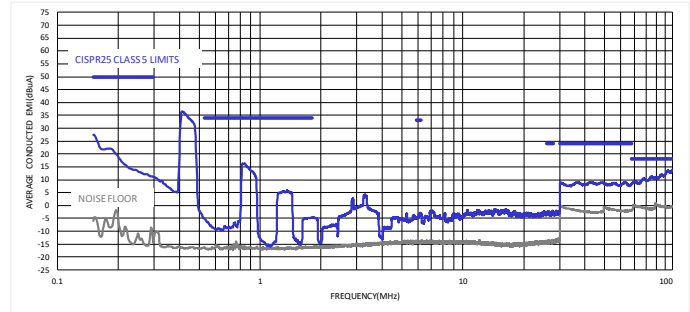

**CISPR25 Class 5 Peak Radiated Emissions**  
150kHz to 30MHz

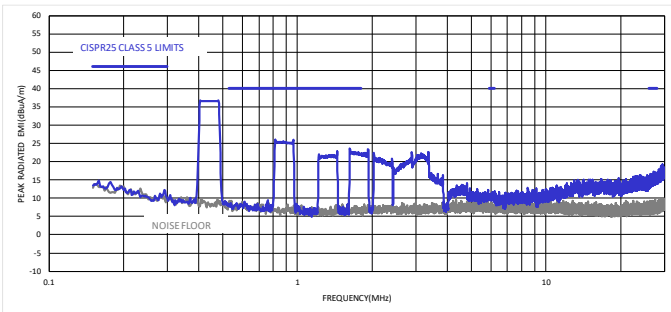

**CISPR25 Class 5 Average Radiated Emissions**  
150kHz to 30MHz

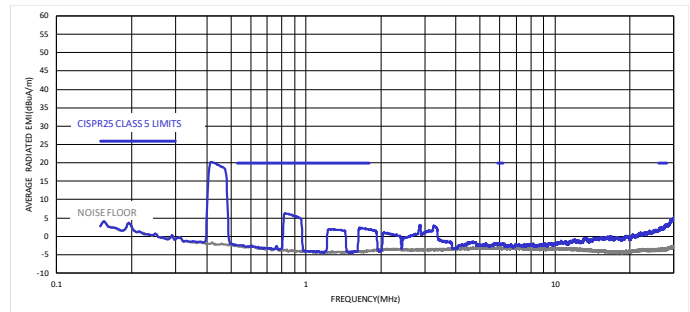

**CISPR25 Class 5 Peak Radiated Emissions**  
Horizontal, 30MHz to 200MHz

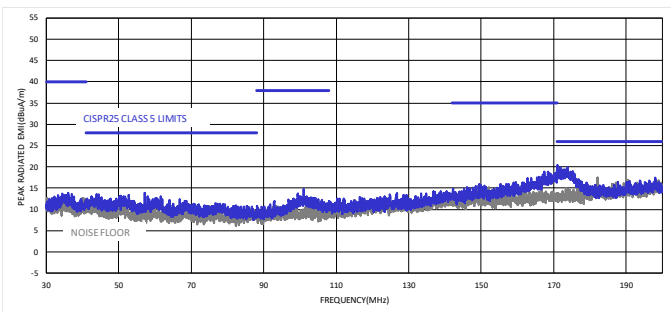

**CISPR25 Class 5 Average Radiated Emissions**  
Horizontal, 30MHz to 200MHz

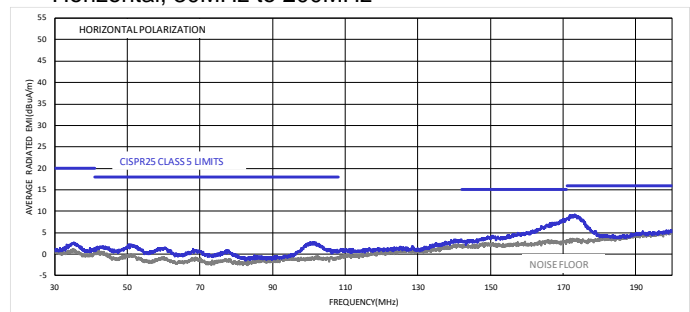

## TYPICAL PERFORMANCE CHARACTERISTICS (continued)

V<sub>IN</sub> = 12V, V<sub>OUT</sub> = 11.5V, I<sub>OUT</sub> = 5A, L = 10μH, f<sub>SW</sub> = 450kHz, in buck-boost mode, with EMI filters and FSS enabled, T<sub>A</sub> = 25°C, unless otherwise noted. (8)

**CISPR25 Class 5 Peak Radiated Emissions**  
Vertical, 30MHz to 200MHz

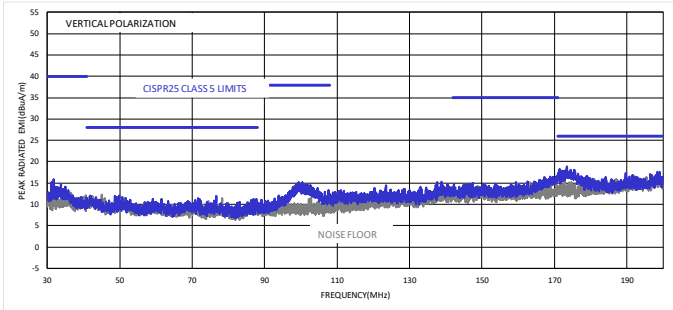

**CISPR25 Class 5 Average Radiated Emissions**  
Vertical, 30MHz to 200MHz

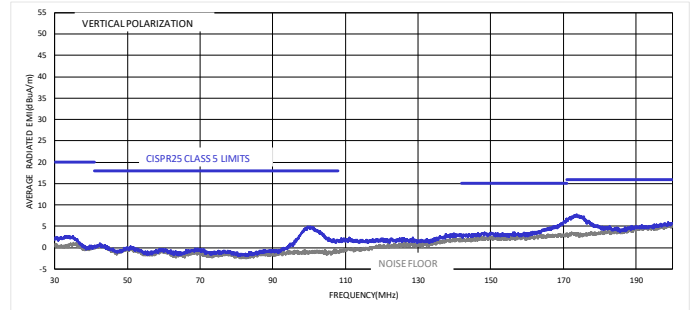

**CISPR25 Class 5 Peak Radiated Emissions**  
Horizontal, 200MHz to 1GHz

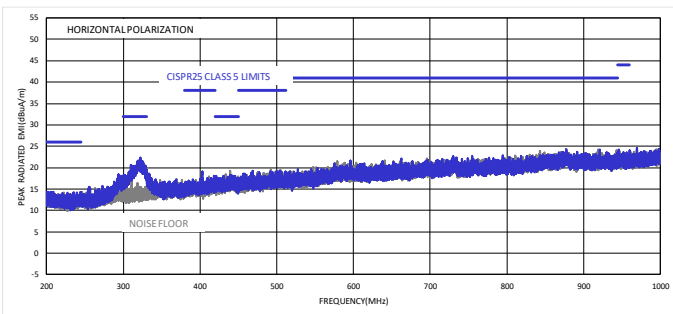

**CISPR25 Class 5 Average Radiated Emissions**  
Horizontal, 200MHz to 1GHz

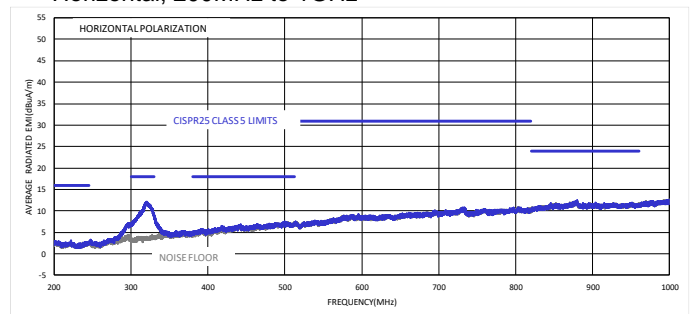

**CISPR25 Class 5 Peak Radiated Emissions**  
Vertical, 200MHz to 1GHz

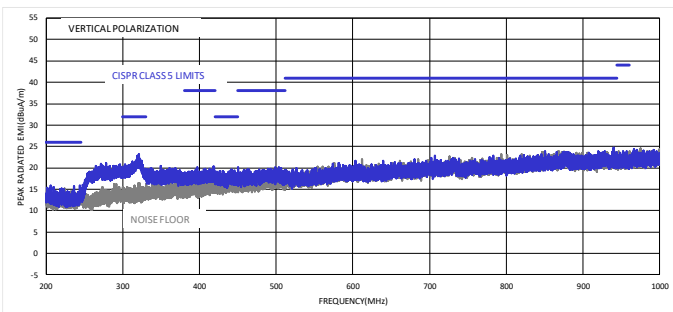

**CISPR25 Class 5 Average Radiated Emissions**  
Vertical, 200MHz to 1GHz

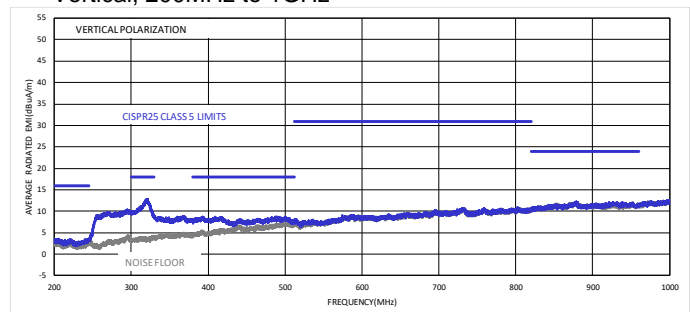

**Notes:**

8) All EMC test results are based on the application circuit with EMI filters (see Figure 34 on page 64).

# FUNCTIONAL BLOCK DIAGRAM

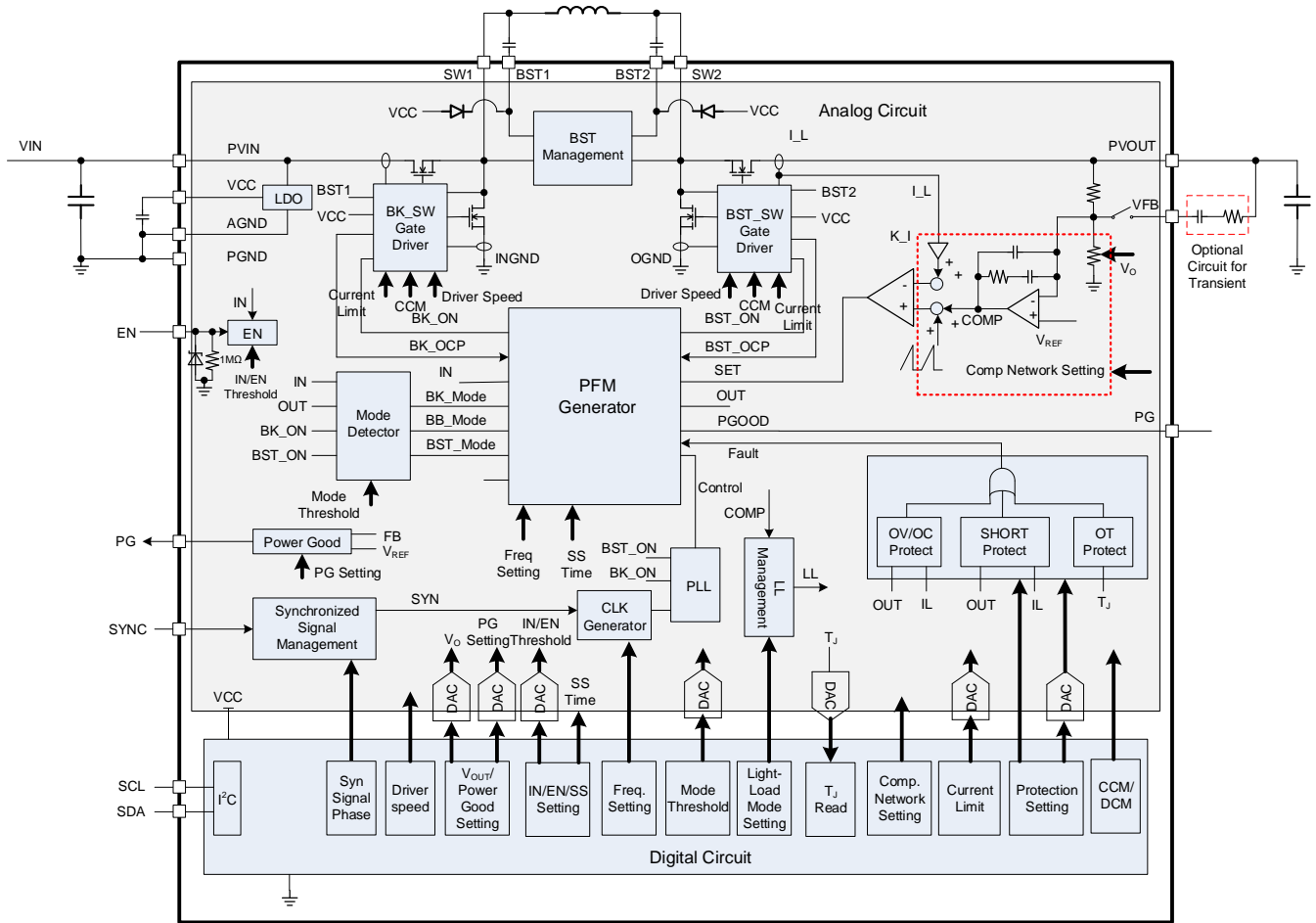

Figure 1: Functional Block Diagram

## OPERATION

The MPQ8875A is a 36V, monolithic, synchronous buck-boost DC/DC converter with a 2.2V to 36V input voltage range. The wide input voltage ( $V_{IN}$ ) range makes this device well-suited for multi-purpose automotive and industrial applications.

Four integrated, low-resistance N-channel MOSFETs minimize the size of the external circuitry. These N-channel MOSFETs also allow the converter to regulate the output voltage ( $V_{OUT}$ ) when  $V_{IN}$  is above, below, or equal to  $V_{OUT}$ . The flexible topology transitions reduce power losses to maximize efficiency.

In addition, the proprietary constant-on-time (COT) control algorithm ensures seamless transitions between the adjacent operational regions. The MPQ8875A can operate across a wide 200kHz to 1MHz switching frequency. This allows applications to be optimized for board size, efficiency, and electromagnetic compatibility (EMC). Most of the electrical characteristics can be configured by accessing the related internal registers via the device's I<sup>2</sup>C interface.

### VCC Regulator

In normal operation, an internal low-dropout (LDO) regulator outputs a nominal 5V VCC supply from PVIN. This supplies power to both control blocks and the four MOSFETs' gate drivers. The VCC regulator has a 60mA current limit to prevent short circuiting the VCC rail. Add a 1 $\mu$ F to 10 $\mu$ F, low-ESR ceramic capacitor to act as the bypass capacitor from VCC to AGND.

The VCC supply cannot maintain a 5V output once PVIN drops below 5V. If PVOUT is sufficient for the VCC power supply (e.g. in boost mode), the reserved 4.55V regulator takes over the VCC supply from PVOUT.

VCC must exceed 2.25V for applications where the input voltage goes down to 2.2V.

### Internal Under-Voltage Lockout (UVLO)

Under-voltage lockout (UVLO) is implemented to avoid the chip (or some blocks) from operating at an insufficient supply voltage. The MPQ8875A incorporates three internal, fixed UVLO comparators to monitor PVIN, VCC, and BST.

There are two PVIN input ranges that can be selected by the I<sup>2</sup>C interface: 4.5V to 36V for normal input mode, and 2.2V to 36V for low-input mode. The PVIN/VCC UVLO levels are not identical when there are different voltage ranges.

The chip is disabled immediately if either PVIN or VCC falls below its respective UVLO threshold. The I<sup>2</sup>C interface cannot work if VCC is not valid.

If  $V_{IN}$  falls below its UVLO threshold, all switching actions are disabled. Then the COMP voltage is pulled down until  $V_{IN}$  exceeds the start-up voltage threshold.

Similarly, if VCC drops below its UVLO threshold, the chip stops switching. Then the COMP voltage is pulled down until VCC rises again.

Since VCC is the internal LDO output from PVIN (or PVOUT in some cases), the actual VCC voltage is determined by  $V_{IN}$  and the dropout voltage of the VCC regulator. The dropout voltage depends on the load current drawn from VCC. In scenarios with a higher switching frequency or larger FET driving capacity demand, the VCC regulator dropout voltage can rise. This means that the VCC can reach its UVLO threshold before the PVIN pin drops below its UVLO threshold.

BST UVLO indicates that there is inadequate driving capacity for the high-side MOSFET (HS-FET). Under this circumstance, the chip stops the HS-FETs from switching and pulls down COMP. The bootstrap charger conducts the low-side MOSFETs (LS-FETs) to charge the BST voltage. The converter restarts with soft start when the BST voltage exceeds its UVLO threshold.

### On/Off Control and Custom Input Under-Voltage Lockout (UVLO)

When EN is driven above its logic threshold (typically 0.85V), the VCC regulator is activated. Once VCC exceeds the VCC UVLO threshold, it starts to provide power to the internal control circuitry. Then the integrated EN comparator begins working.

If the EN voltage exceeds the comparator’s upper threshold (typically 1.55V), the converter is enabled and soft start begins. If EN drops below the comparator’s lower threshold, the converter stops switching. The VCC regulator and control circuitry continue working until the EN pin is pulled below its logic threshold (<0.5V). Then the MPQ8875A shuts down and consumes very little input current. The total supply current is reduced to <25 $\mu$ A.

In addition to serving as normal on/off logic control, the integrated EN comparator can set the EN pin to a custom input UVLO threshold by adding an external resistor divider from PVIN to GND (see Figure 2).

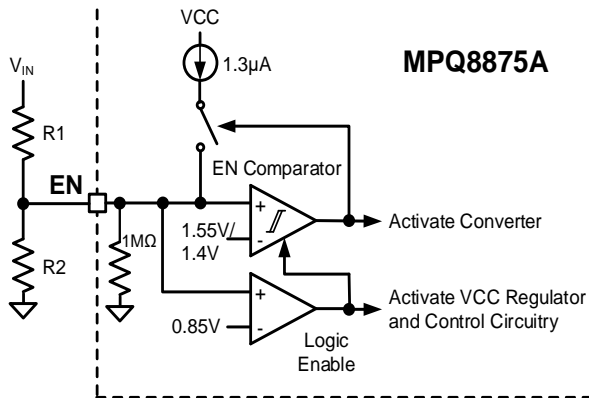

**Figure 2: Custom Input UVLO Set by EN**

The EN voltage is set via the resistor divider ratio from PVIN. When EN reaches 1.55V (the rising UVLO threshold of the integrated EN comparator), the converter starts switching. Meanwhile, an internal 1.3 $\mu$ A pull-up current source is enabled to source current from the EN pin.

To disable the converter when  $V_{IN}$  drops, the EN voltage must drop below the UVLO threshold of the EN comparator. This means  $V_{IN}$  must fall enough to overcome the hysteresis from the 1.3 $\mu$ A pull-up current, as well as the inherent 150mV hysteresis of the EN comparator. As a result, the actual hysteresis can be set independently without changing the rising UVLO threshold.

In addition to EN logic, the converter can be turned on/off via the I<sup>2</sup>C interface. Set register 01h, bit[7] to 1 to turn the MPQ8875A on; set it to 0 to turn the MPQ8875A off.

### Constant-On-Time (COT) Control

The MPQ8875A employs constant-on-time (COT) control to achieve fast load transient response. Figure 3 shows the COT control block diagram.

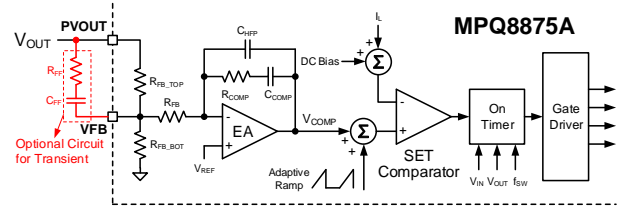

**Figure 3: COT Control**

The operational error amplifier (EA) corrects any error voltage between  $V_{FB}$  and  $V_{REF}$ . With the help of the EA, the MPQ8875A can provide excellent load regulation across the whole load range, regardless of whether the device operates in forced continuous conduction mode (FCCM) or discontinuous conduction mode (DCM). It also features internal ramp compensation. The adaptive internal ramp is optimized so that the converter is stable across the entire operating voltage range, with proper design of the external components. Figure 4 shows how the switching cycle is generated.

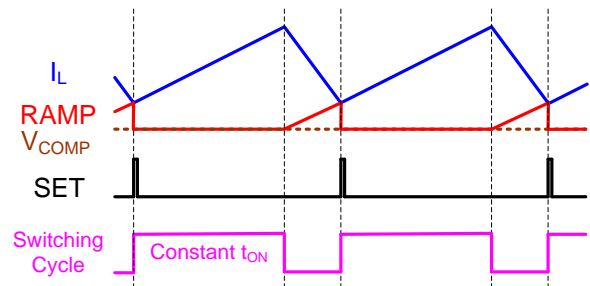

**Figure 4: Switching Cycle Generation**

The EA corrects the error between  $V_{FB}$  and  $V_{REF}$  to output a fairly smooth DC voltage ( $V_{COMP}$ ). The internal ramp compensation is added onto  $V_{COMP}$ . The combined  $V_{COMP}$  is compared to the inductor current-sense signal ( $I_L$ ).

When  $I_L$  drops below the combined  $V_{COMP}$ , the set comparator outputs a SET signal to begin a new switching cycle. The converter’s on time is fixed and determined by  $V_{IN}$ ,  $V_{OUT}$ , and the selected switching frequency. Once the on interval elapses, the main MOSFET turns off. Then the coupled synchronous rectifier (SR) switch turns on after a dead time to avoid shoot-through.

In FCCM, the SR switch remains on until the next SET signal comes or the reverse current limit is triggered. By repeating this operation, the MPQ8875A regulates  $V_{OUT}$ .

### Four-Switch Power Converter

Figure 5 shows the topology of the four-switch power converter, which is comprised of four N-channel MOSFETs. Q1 and Q3 work as the main switches, while Q2 and Q4 act as the SR switches. The switches are properly controlled so that transitions between buck, buck-boost, and boost mode is continuous according to  $V_{IN}$  and  $V_{OUT}$ .

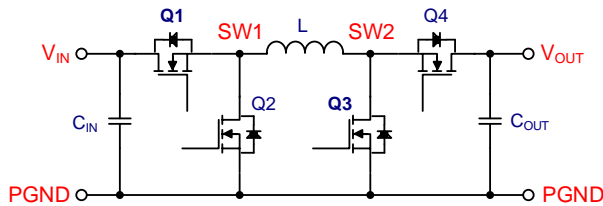

**Figure 5: Four-Switch Power Converter**

When stepping down from a higher  $V_{IN}$  to a lower  $V_{OUT}$ , the converter operates in buck mode (see Figure 6 and Figure 7). Q4 remains on and Q3 remains off for the entire switching cycle. Q1 and Q2 switch alternately, and behave like a typical synchronous buck converter. Q1's on time is fixed, and the off time can be adjusted via the control algorithm. Figure 6 shows buck mode in FCCM.

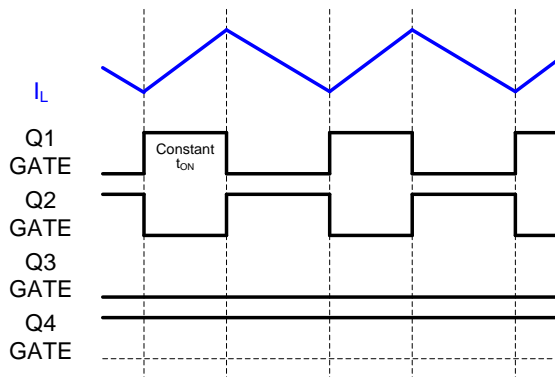

**Figure 6: Buck Mode in FCCM**

Figure 7 shows buck mode in DCM.

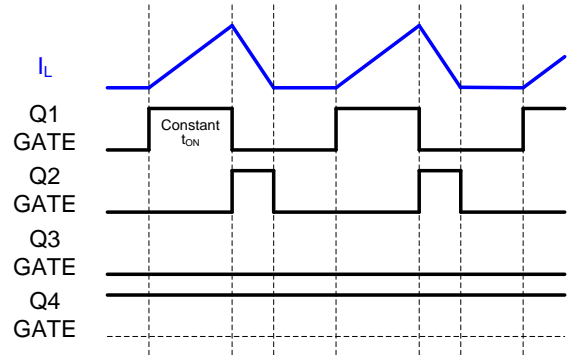
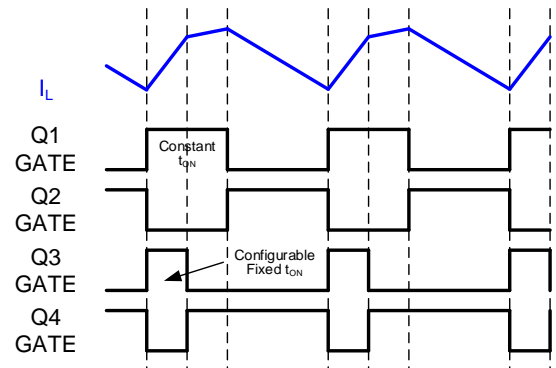

**Figure 7: Buck Mode in DCM**

If  $V_{IN}$  is close to  $V_{OUT}$ , the converter enters buck-boost mode (see Figure 8 and Figure 9). Q1 and Q2 still operate independently like a synchronous buck regulator. Q1's on time is fixed, and its off time can be adjusted by the control algorithm. Q3 switches on synchronously with Q1, and remains on for a constant duty cycle, which can be configured based on the switching frequency. Then Q3 turns off, and Q4 switches on.

When Q1 and Q4 are on at the same time, the voltage across inductor is the voltage difference between  $V_{IN}$  and  $V_{OUT}$ . This value is so low that the inductor current is smooth during this period.

Figure 8 shows buck-boost mode in FCCM when  $V_{IN}$  exceeds  $V_{OUT}$ .



**Figure 8: Buck-Boost Mode in Normal FCCM ( $V_{IN} > V_{OUT}$ )**

Figure 9 shows buck-boost mode in DCM when  $V_{IN}$  exceeds  $V_{OUT}$ .



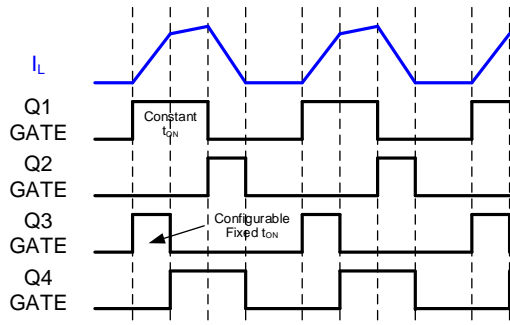

**Figure 9: Buck-Boost Mode in Normal DCM ( $V_{IN} > V_{OUT}$ )**

Figure 10 shows buck-boost mode in FCCM when  $V_{OUT}$  exceeds  $V_{IN}$ .

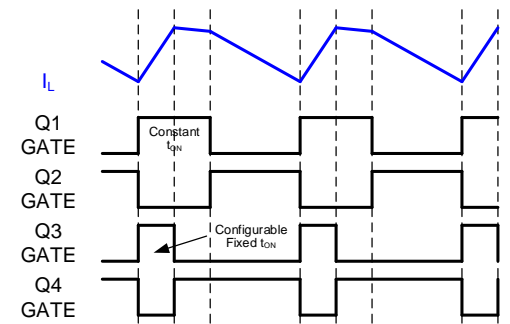

**Figure 10: Buck-Boost Mode in Normal FCCM ( $V_{IN} < V_{OUT}$ )**

Figure 11 shows buck-boost mode in FCCM when  $V_{OUT}$  exceeds  $V_{IN}$ .

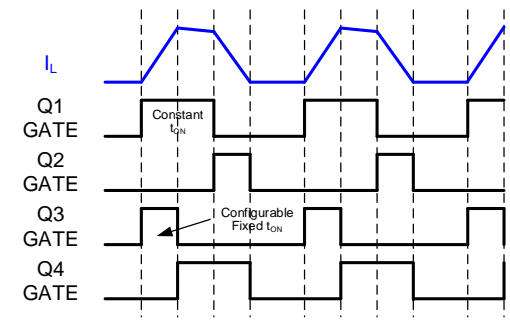

**Figure 11: Buck-Boost Mode in Normal DCM ( $V_{IN} < V_{OUT}$ )**

If  $V_{IN}$  is below  $V_{OUT}$ , the MPQ8875A operates in boost mode (see Figure 12 and Figure 13). Q1 remains on and Q2 remains off for the entire switching cycle. Q3 and Q4 are modulated to switch alternately, behaving like a typical synchronous boost regulator. Q3's on time is fixed, and its off time can be adjusted by the control algorithm.

Figure 12 shows boost mode in FCCM.

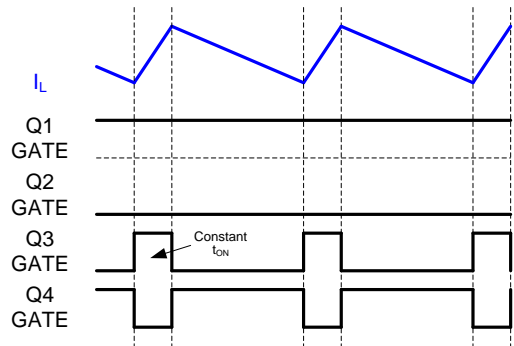

**Figure 12: Boost Mode in FCCM**

Figure 13 shows boost mode in DCM.

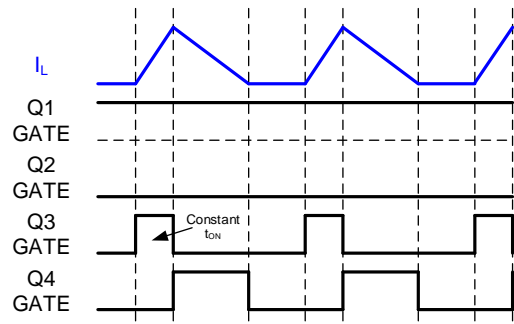

**Figure 13: Boost Mode in DCM**

The mode-to-mode transition is automatic by comparing the sensed  $V_{IN}$  and sensed  $V_{OUT}$ . Figure 14 shows the power converter's regions of operation.

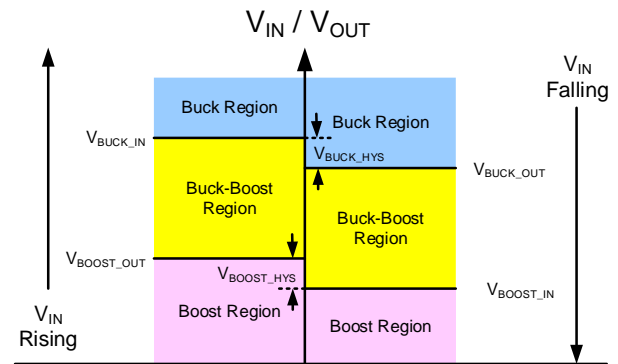

**Figure 14: Regions of Operation**

If  $V_{IN}$  is significantly lower than the sensed  $V_{OUT}$ , the MPQ8875A works in boost mode. When  $V_{IN}$  exceeds  $V_{BOOST\_OUT}$ , the device transitions into buck-boost mode. If  $V_{IN}$  reaches  $V_{BUCK\_IN}$ , then buck mode is activated. Alternately, if  $V_{IN}$  drops from a higher value to a lower one, the converter operates in buck mode, buck-boost mode, and boost mode successively.



To avoid unexpected, repetitive mode transitions when  $V_{IN}$  is close to the critical status between adjacent regions, there is a transition threshold hysteresis.

### Bootstrap and Floating Driver

The bootstrap circuitry drives the high-side N-channel MOSFETs (Q1 and Q4). The external flying capacitors are charged up to maintain a sufficient driving voltage above SW via the internal bootstrap regulators.

At start-up, the bootstrap pre-charge process starts before the converter is ready for normal operation. Both LS-FETs (Q2 and Q3) turn on to force SW1 and SW2 low, allowing the bootstrap regulators to charge the flying capacitors from the VCC supply via the BST1 and BST2 pins, respectively. If the current limit is triggered, the LS-FETs turn off. The LS-FETs may switch several times before building up enough driving voltage across the flying capacitors. Then soft start begins.

If the converter is operating in buck-boost mode, the flying BST capacitor can be charged while the corresponding LS-FET is conducted.

However, in buck mode and boost mode, one HS-FET remains on, and its relevant LS-FET remains off for the entire switching cycle. Under this condition, the BST capacitors can charge each other through the internal charge regulator.

### Error Amplifier

The MPQ8875A integrates a high-performance operational amplifier to implement control loop compensation for stable  $V_{OUT}$  regulation (see Figure 15).

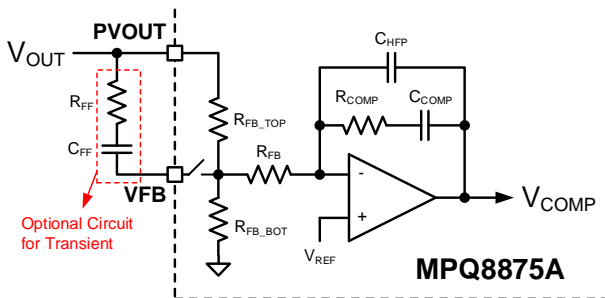

**Figure 15: Compensation Network**

Figure 15 shows the typical Type II compensation network that is fully integrated into the MPQ8875A. Component values can be configured via the I<sup>2</sup>C interface. An external  $V_{OUT}$  sensing resistor divider, as well as

compensation network components, are not required.

To optimize the converter’s transient response, a Type III compensation network is also available. The Type III compensation network is comprised of the internal, existing Type II compensation network, plus an external RC compensation network tied between the PVOUT and VFB pins (see Figure 15). If a Type III compensation network or an external output voltage sensing resistor divider is required, set 0Dh, bit[1] to 1.

### Oscillator and Synchronization Input/Output

The MPQ8875A converter’s switching frequency can be configured to be between 200kHz and 1MHz via the I<sup>2</sup>C interface. The COT control algorithm determines the on time based on  $V_{IN}$ ,  $V_{OUT}$ , and the operating switching frequency.

For EMI-sensitive applications, the switching clock can be synchronized to an external clock signal applied to the SYNC pin if synchronization input mode is enabled. The synchronization clock frequency ranges between 250kHz and 1MHz, and must be 20% greater than the configured frequency set in the one-time programmable (OTP) register. The square-wave amplitude should have a peak above 1.4V and a valley below 0.5V. The width of the synchronization pulse should be >200ns.

The MPQ8875A can operate in the designated switching frequency (via the I<sup>2</sup>C interface or external clock signal) in FCCM. Once the converter enters DCM, the switching frequency is self-adjusting based on the control algorithm.

The SYNC pin can also be configured to synchronized output mode. The MPQ8875A can output the internal clock with a 0° or 180° phase shift. For example, for a two-device system sharing a common input power supply, one MPQ8875A can output its clock signal with a 180° phase shift to synchronize to the other device’s switching clock.

As a result, both devices can operate in the same frequency, but with a 180° phase difference to reduce the total input voltage/current ripple.

This allows a lower-value input bypass capacitor to be used. The output synchronization clock's duty cycle is constant at 50%.

### Frequency Spread Spectrum (FSS)

To further optimize EMI performance, the MPQ8875A features frequency spread spectrum (FSS) (see Figure 16).

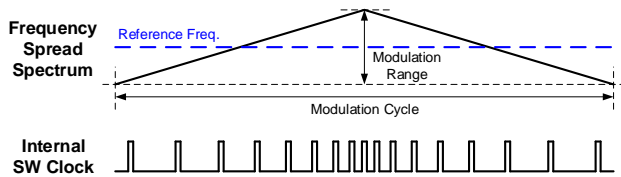

**Figure 16: Frequency Spread Spectrum**

The reference frequency, as well as the FSS modulation range and cycle, are all set via the I<sup>2</sup>C interface. Once FSS is enabled, triangular frequency modulation varies the switching frequency between the same ratio, which is both higher and lower than the reference value. During a full modulation cycle, the switching frequency varies from the lowest to the highest value, then drops back to the lowest value.

If an external clock signal is applied to the SYNC pin in synchronized input mode, the FSS mechanism is screened. That means FSS is unavailable in synchronization input mode.

### Discontinuous Conduction Mode (DCM) and Forced Continuous Conduction Mode (FCCM) under Light Loads

In normal operation, the converter works in forced continuous conduction mode (FCCM) under heavier loads. The inductor current ( $I_L$ ) never drops to 0A during the switching cycle. The switching frequency ( $f_{sw}$ ) is fairly constant, and it can be configured via the I<sup>2</sup>C interface.

When the load current drops or there is no load, the converter experiences a light-load or no-load condition. The MPQ8875A can operate in discontinuous conduction mode (DCM) or FCCM under light-load conditions.

DCM is applied to optimize efficiency under light-load or no-load conditions. While the synchronous rectifier (SR) turns on, the inductor current falls linearly. When the load current continues to decrease, the  $I_L$  valley reaches 0A. If DCM is employed, the active SR switch stops switching once  $I_L$  reaches 0A (see Figure 17).

This means that  $I_L$  cannot drop to the negative value, and the output capacitor cannot be discharged further.

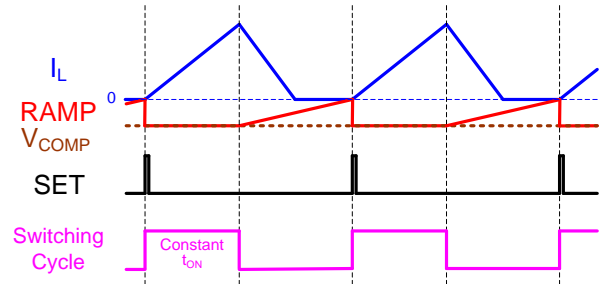

**Figure 17: DCM under Light-Load Conditions**

Based on the COT control algorithm,  $I_L$  stops falling, but the combined  $V_{COMP}$  can rise up continually with the ramp compensation. When the combined  $V_{COMP}$  reaches  $I_L$ , a SET signal initiates a new switching cycle. In DCM,  $f_{sw}$  is self-adjusting and does not follow the switching frequency setting until the converter resumes FCCM with load increments.

When FCCM is enabled,  $I_L$  can drop to the negative value as long as the reverse current limit is not triggered (see Figure 18). The converter acts as it would with a heavy load, and can maintain  $f_{sw}$  to regulate  $V_{OUT}$ , regardless of the output current. FCCM results in a smaller output ripple, but has lower efficiency under light-load conditions.

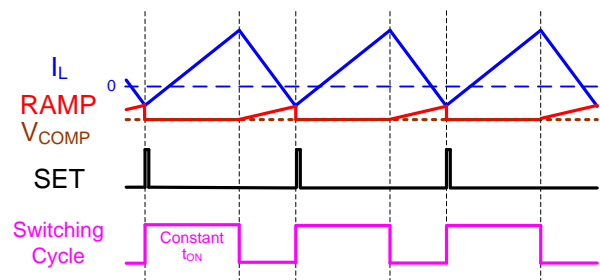

**Figure 18: FCCM under Light-Load Conditions**

### Soft Start (SS)

Once  $V_{IN}$ ,  $V_{CC}$ , and  $EN$  are all enabled, the converter begins switching, and the internal soft start is implemented.

The MPQ8875A's built-in soft start (SS) ramps up the internal reference voltage ( $V_{REF}$ ) from 0V to the expected value with a controlled slew rate. This slew rate can be configured via the I<sup>2</sup>C interface.  $V_{OUT}$  can ramp up slowly to prevent the converter's output voltage from overshooting during start-up.

### Dynamic Output Voltage Adjustment

If the MPQ8875A operates in its normal input range (4.5V to 36V),  $V_{REF}$  can be adjusted from 0.5V to 2.0V with a 10mV resolution. The converter features dynamic  $V_{OUT}$  adjustments by changing  $V_{REF}$  from the current value to the set value.  $V_{REF}$  falls and rises in 10mV steps (see Figure 19 and Figure 20).

By controlling the time between steps using the I<sup>2</sup>C interface, the reference voltage variation slew rate can be adjusted. A longer time between steps results in a slower slew rate. Conversely, the slew rate increases by using a shorter time between steps. Figure 19 shows how  $V_{REF}$  is adjusted while it increases.

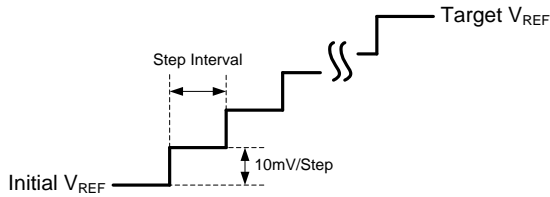

**Figure 19:  $V_{REF}$  Adjustment ( $V_{REF}$  Increasing)**

Figure 20 shows how  $V_{REF}$  is adjusted while it decreases.

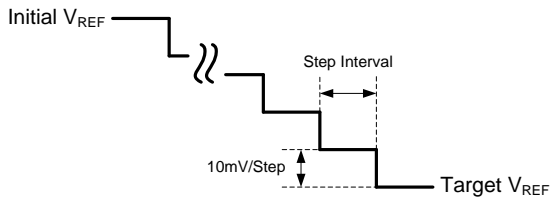

**Figure 20:  $V_{REF}$  Adjustment ( $V_{REF}$  Decreasing)**

$V_{OUT}$  regulation is implemented by the converter control loop. The  $V_{OUT}$  adjustment, like the  $V_{REF}$  alteration, is dependent on the control loop stability. A slower slew rate helps achieve a smooth, monotonic  $V_{OUT}$  adjustment.

### Power Good (PG) Indicator

The PG pin is connected to the open drain of an internal MOSFET. PG should be connected to a voltage source through an external pull-up resistor to act as the power good indicator. The PG pin is pulled down to ground during soft start, or if  $V_{OUT}$  is not within the allowable window. When  $V_{OUT}$  is in regulation, the PG MOSFET turns off, and the PG pin can be pulled high to indicate a good output status. There is a delay time of about 30 $\mu$ s if the PG status flip flops.

The PG threshold and hysteresis can be configured via the I<sup>2</sup>C interface.

### Input Over-Voltage Protection (OVP)

If input over-voltage protection (OVP) is required, the chip can provide an input OVP threshold at 11V, 22V, or 33V. Once  $V_{IN}$  exceeds this threshold, the converter stops switching immediately and sets the input OV fault flag. Once  $V_{IN}$  returns to within the normal range, the MPQ8875A automatically resumes normal operation.

The user can enable input OVP and select the threshold/recovery hysteresis via the I<sup>2</sup>C interface.

### Output Over-Voltage Protection (OVP)

The MPQ8875A monitors  $V_{OUT}$  with the PVOOUT pin. The VFB pin is connected to the tap of the internal output feedback resistor divider. If  $V_{OUT}$  exceeds the output over-voltage protection (OVP) threshold, the converter stops switching immediately, and an output OV fault is recorded.

There are two types of the optional output OVP modes: recoverable mode and latch-off mode.

The output OVP mode, threshold, and recovery hysteresis can be selected via the I<sup>2</sup>C interface.

### Over-Current Protection (OCP)

The MPQ8875A provides a peak/valley current limit scheme designed to limit the peak/valley inductor current to ensure that the switching currents remain within the device capabilities during overload conditions or during an output short circuit.

When the main power switch turns on, the chip monitors the increased  $I_L$  through the relevant operating main power switch. Once the peak  $I_L$  exceeds the peak current limit threshold, the relevant operating main power switch turns off immediately, and the relevant operating SR switch turns on to conduct and decrease  $I_L$ . The operating main power switch does not turn on again until  $I_L$  falls below the valley current limit threshold. This peak/valley current limit scheme ensures that  $I_L$  decreases sufficiently when the relevant operating main power switch is off. As a result, the average  $I_L$  is limited to a safe range.

If the internal EA's output level triggers the high clamp limit consecutively in a settled cycle, an over-current (OC) fault is recorded and OCP is

activated. There are three optional OCP modes: recoverable, latch-off, and no response mode. OCP is screened during soft start.

When the SR switch is conducting,  $I_L$  drops. In some conditions (e.g. FCCM under light loads), the converter can actively conduct current away from the output. When  $I_L$  falls below 0A, a reverse inductor current occurs. To prevent damage to the part due to excessive reverse current, the MPQ8875A monitors the current entering the relevant operating SR switch from the output. If this current exceeds the reverse current limit threshold, the relevant operating SR switch turns off and the relevant operating main switch conducts to reduce the reverse current.

The OCP mode, peak/valley current limit threshold, and reverse current limit threshold can be selected via the I<sup>2</sup>C interface.

### Under-Voltage (UV) and Short-Circuit Protection (SCP)

A short circuit is the worst overload condition. In addition to over-current protection, the MPQ8875A provides short-circuit protection (SCP) in the event of a hard output short. SCP is triggered if  $V_{OUT}$  falls below the under-voltage (UV) threshold for a set period. Then an output UV fault is triggered, and the converter stops immediately. There are three optional output SCP/UVP modes: recoverable, latch-off, and no response mode. Output UV detection does not work during soft start.

The output UVP mode, threshold, and detection time can be selected via the I<sup>2</sup>C interface.

### Thermal Protection

Thermal shutdown is implemented to prevent the MPQ8875A from operating at exceedingly high temperatures. If the silicon die temperature exceeds the thermal shutdown threshold, the over-temperature (OT) fault shuts down the whole chip. The thermal shutdown protection is auto-recoverable. Once the die temperature drops below its lower threshold, the chip starts up again and resumes normal operation.

The thermal shutdown threshold and recovery hysteresis can be selected via the I<sup>2</sup>C interface. In addition, the MPQ8875A provides instantaneous die temperature information by reading the relevant register.

### Fault Response

Once a fault status is confirmed, the converter turns off the main switches (Q1 and Q3) immediately after the minimum on time ends. The SR switches (Q2 and Q4) conduct  $I_L$  until it reaches 0A, regardless of whether the device is in DCM or FCCM. Finally, all four switches stop.

After a fault occurs, the converter operates based on the corresponding fault mode setting. There are three operating schemes: recoverable, latch-off, and no response mode.

In recoverable mode, the chip attempts to restart the converter. After the converter completely shuts down, a fault recovery timer starts. After a configurable delay time, the converter attempts to soft start automatically. If the fault condition is not removed, the converter reinitiates the fault protection and repeats the auto-recovery process in hiccup mode. If the fault condition is removed once soft start ends and the converter operates normally for a consecutive 30 $\mu$ s, then the fault status resets.

Latch-off mode stops the converter until the power on the input supply or EN is recycled.

For OCP and UVP, no response mode can be selected. In this mode, the converter maintains switching in the peak/valley current limit unless thermal shutdown is triggered.

### One-Time Programmable (OTP) Memory

The MPQ8875A provides a one-time programmable (OTP) memory function for setting the custom default parameters.

MPS provides a GUI and I<sup>2</sup>C tool to configure the MPQ8875A during the development process. To configure in applications, contact an MPS FAE via our website.

The OTP can be written three times, which means that there are three OTP pages. The OTPCNT bit records the remaining OTP pages.



## I<sup>2</sup>C INTERFACE

### I<sup>2</sup>C Serial Interface Description

The I<sup>2</sup>C bus is a two-wire, bidirectional serial interface, consisting of a serial data line (SDA) and a serial clock line (SCL). The lines are externally pulled to a bus voltage when they are idle.

When connected to the line, a master device generates the SCL signal and device address, then arranges the communication sequence. The MPQ8875A works as a slave-only device, which supports up to 400kbs of bidirectional data transfer in fast mode. This adds flexibility to the power supply solution. The output voltage, transition slew rate, and other converter parameters can be instantaneously controlled via the I<sup>2</sup>C interface.

The I<sup>2</sup>C interface uses VCC as its power source. If VCC cannot reach the under-voltage lockout (UVLO) threshold, the SDA and SCL lines are at a high-impedance status, and the I<sup>2</sup>C interface stops working.

### Data Validity

One clock pulse is generated for each data bit transferred. The data on the SDA line must be stable during the high period of the clock. The high or low state of the SDA line can only change when the clock signal on the SCL line is low (see Figure 21).

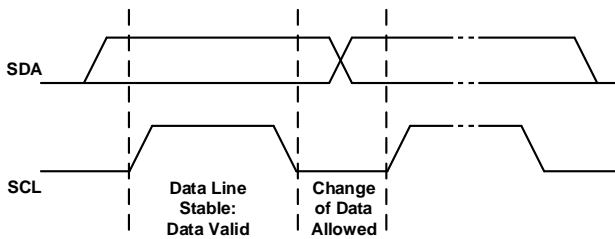

Figure 21: Bit Transfer on the I<sup>2</sup>C Bus

### Start and Stop Conditions

The start (S) and stop (P) conditions are signaled by the master device, which signifies the beginning and the end of the I<sup>2</sup>C transfer. The start condition is defined as the SDA signal transitioning from high to low while the SCL line is high. The stop condition is defined as the SDA signal transitioning from low to high while the SCL line is high (see Figure 22).

Start and stop conditions are always generated by the master. The bus is considered busy after

the start condition. The bus is considered free again after a delay following the stop condition. The bus stays busy if a repeated start (Sr) is generated instead of a stop condition. The start and repeated start conditions are functionally identical.

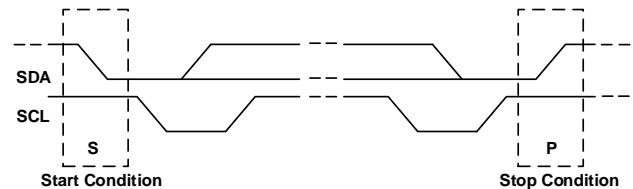

Figure 22: Start and Stop Conditions

### Transfer Data

Every byte put on the SDA line must be 8 bits long. Each byte must be followed by an acknowledge (ACK) bit. The acknowledge-related clock pulse is generated by the master. The transmitter releases the SDA line (high) during the acknowledge clock pulse. The receiver must pull down the SDA line during the acknowledge clock pulse, so that it remains stable (low) during the high period of the clock pulse.

Figure 23 shows the data transfer format. After the start condition, a slave address is sent. This address is 7 bits long, followed by an 8th data direction bit (R/W). A 0 indicates a write transmission, and a 1 indicates a read or a request for data. A data transfer is always terminated by a stop condition generated by the master. However, if a master must communicate on the bus, it can generate a repeated start condition (Sr) and address another slave without first generating a stop condition.

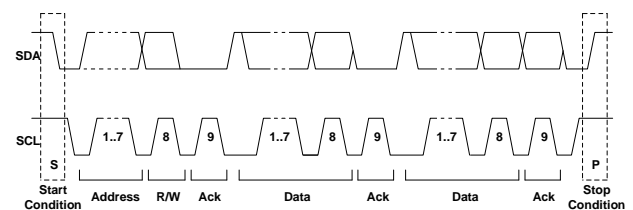

Figure 23: Complete Data Transfer

### Write Sequence

A write sequence for the MPQ8875A requires a start condition, a valid slave address, a register index byte, and a corresponding data byte for a single data update.

After receiving each byte, the MPQ8875A acknowledges this transfer by pulling the SDA line low during the high period of a single clock pulse. A valid I<sup>2</sup>C address selects the MPQ8875A. The MPQ8875A then performs an update on the falling edge of the LSB byte.

**Read Sequence**

The typical MPQ8875A read sequence is 4 bytes long. It begins with a start condition from the master, then a valid slave address followed by a register index byte. The read sequence differs from the write sequence in that a master’s start condition comes again. The bus direction then turns around with the rebroadcast of the slave address, with bit 1 indicating a read

cycle. The following 4th byte contains the data being returned by the MPQ8875A. That byte value in the data byte reflects the value of the register index that was queried before.

**Chip Address**

The MPQ8875A supports 16 different addresses from 00h to 0Fh, which can be preset in register 08h via the I<sup>2</sup>C bus.

When the master sends the address as an 8-bit value, the 7-bit address should be followed by a 0 or 1 to indicate a write or read operation, respectively. Figure 24 shows a write sequence, and Figure 25 shows a read sequence.

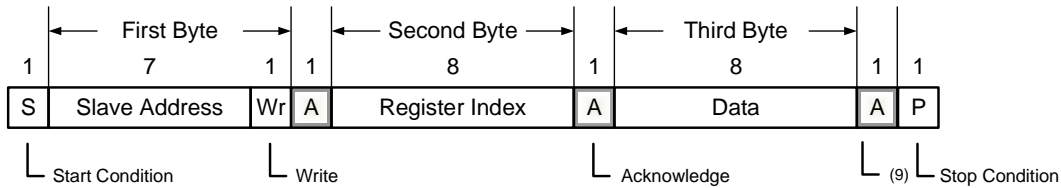

**Figure 24: Write Sequence** <sup>(9)</sup>

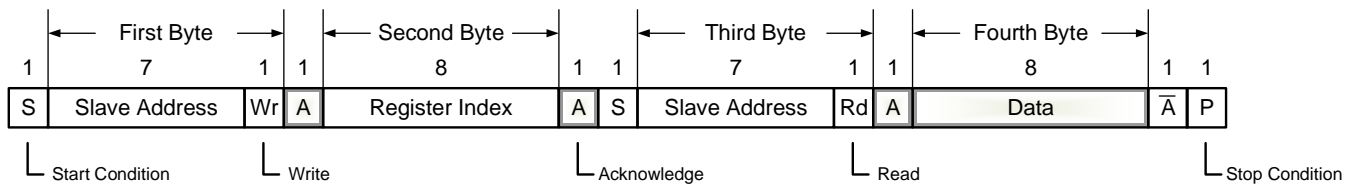

**Figure 25: Read Sequence** <sup>(9)</sup>

**Note:**

9) A dark gray outline indicates cycles in which the MPQ8875A owns or drives the SDA line. The master device drives all other cycles.

**Register Map**

Register Index	Default <sup>(10)</sup>	Bit 7	Bit 6	Bit 5	Bit 4	Bit 3	Bit 2	Bit 1	Bit 0	
<b>00h</b>	32h	Reference Voltage								
<b>01h</b>	84h	Power Converter On/Off	RSVD <sup>(11)</sup>	RSVD <sup>(11)</sup>	V <sub>OUT</sub> Dynamic Adjustment Step Time		V <sub>OUT</sub> Divider Ratio			
<b>02h</b>	00h	SW1 Switching Rising Slew Rate		SW1 Switching Falling Slew Rate		SW2 Switching Rising Slew Rate		SW2 Switching Falling Slew Rate		
<b>03h</b>	08h	Synchronization Mode			Switching Frequency					
<b>04h</b>	00h	Frequency Spread Spectrum On/Off	Frequency Spread Spectrum Modulation Range			RSVD <sup>(11)</sup>	Frequency Spread Spectrum Modulation Cycle			
<b>05h</b>	7Fh	DCM/FCCM	Reverse Current Limit	Valley Current Limit			Peak Current Limit			
<b>06h</b>	00h	Compensation Network R <sub>FB</sub>			Compensation Network R <sub>COMP</sub>					
<b>07h</b>	00h	Compensation Network C <sub>HFP</sub>			Compensation Network C <sub>COMP</sub>					
<b>08h</b>	00h	I <sup>2</sup> C Address				Cycle Extension in Buck-Boost On/Off	RSVD <sup>(11)</sup>	Constant-On-Time of Boost Switch in Buck-Boost Mode		
<b>09h</b>	EEh	Transition Hysteresis between Buck and Buck-Boost		Threshold of Buck-Boost Transiting to Buck		Transition Hysteresis between Boost and Buck-Boost		Threshold of Boost Transiting to Buck-Boost		
<b>0Ah</b>	00h	Gain for Inductor Current Sense	DC Bias for Inductor Current Sense		Ramp Compensation Peak to Valley		Ramp Compensation			
<b>0Bh</b>	00h	Power Good High Limit Hysteresis	Power Good High Limit	Power Good Low Limit Hysteresis	Power Good Low Limit	Over-Current Counter		OCP Mode		
<b>0Ch</b>	60h	Fault Protection Mode	Delay Time for Fault Recovery		FB Threshold for UVP	Under-Voltage Counter		UVP Mode		
<b>0Dh</b>	04h	V <sub>IN</sub> OVP Hysteresis	V <sub>IN</sub> Over-Voltage Threshold		V <sub>OUT</sub> OVP Hysteresis	V <sub>OUT</sub> Over-Voltage Threshold		ENFBO	OVP Mode	
<b>0Eh</b>	0Ah	RSVD <sup>(11)</sup>	Junction Temperature Range			Thermal Shutdown Hysteresis		Thermal Shutdown Threshold		
<b>0Fh</b>	00h	OTP Counter		Power Good Status	Input Over-Voltage Status	RSVD <sup>(11)</sup>	RSVD <sup>(11)</sup>	RSVD <sup>(11)</sup>	Thermal Shutdown Status	
<b>10h</b>		Manufacturer Code[4:0]					Silicon Rev[2:0]			

**Notes:**

10) Initial factory defaults. The default value can be redefined if the OTP function is available.

11) This bit is not defined, and is reserved for future use. Reserved bits always read as 0. For compatibility with future devices, reserved bits should be written to “0” if accessed.

## REGISTER DESCRIPTION

Register 00h							
Bit[7] (R/W)	Bit[6] (R/W)	Bit[5] (R/W)	Bit[4] (R/W)	Bit[3] (R/W)	Bit[2] (R/W)	Bit[1] (R/W)	Bit[0] (R/W)
REF7	REF6	REF5	REF4	REF3	REF2	REF1	REF0
Bit Field Definitions							
Bits	Field Name	Description					
7:0	REF[7:0]	Sets the reference voltage, calculated with the following equation: <b>In normal input mode:</b> 00h to 31h: Reserved 32h to C8h: $V_{REF} = REF[7:0] \times 10\text{mV}$ (resolution: 10mV) C9h to FFh: Reserved <b>In low input mode:</b> 00h to 31h: Reserved 32h to 78h: $V_{REF} = REF[6:0] \times 10\text{mV}$ (resolution: 10mV) 79h to FFh: Reserved In low input mode REF7 bit is invalid.					

Register 01h																					
Bit[7] (R/W)	Bit[6] (R/W)	Bit[5] (R/W)	Bit[4] (R/W)	Bit[3] (R/W)	Bit[2] (R/W)	Bit[1] (R/W)	Bit[0] (R/W)														
PWRCVTEN	INMD	RESERVED	DVSTEP1	DVSTEP0	FBDR2	FBDR1	FBDR0														
Bit Field Definitions																					
Bits	Field Name	Description																			
7	PWRCVTEN	This bit enables power converter on/off control. 0: Disabled 1: Enabled																			
6	INMD	Selects normal mode or low-input mode. 0: Normal input mode 1: Low-input mode																			
5	RESERVED	Reserved.																			
4:3	DVSTEP [1:0]	Sets the time of each step during soft start and output voltage dynamic adjustment mode (in $\mu\text{s}$ ). <table border="1" style="margin-left: 20px;"> <tr> <td>00h</td> <td>20</td> <td>01h</td> <td>41.67</td> </tr> <tr> <td>02h</td> <td>83.33</td> <td>03h</td> <td>166.67</td> </tr> </table>	00h	20	01h	41.67	02h	83.33	03h	166.67											
00h	20	01h	41.67																		
02h	83.33	03h	166.67																		
2:0	FBDR[2:0]	Sets the divider ratio of the reference voltage and output voltage. <table border="1" style="margin-left: 20px;"> <tr> <td>00h</td> <td>1</td> <td>01h</td> <td>1/2</td> </tr> <tr> <td>02h</td> <td>1/3</td> <td>03h</td> <td>1/5</td> </tr> <tr> <td>04h</td> <td>1/10</td> <td>05h</td> <td>1/20</td> </tr> <tr> <td>06h/07h</td> <td>1/30</td> <td>-</td> <td>-</td> </tr> </table> For example, if FBDR[2:0] = 04h, then $V_{FB} = 1/10 \times V_{OUT}$ .	00h	1	01h	1/2	02h	1/3	03h	1/5	04h	1/10	05h	1/20	06h/07h	1/30	-	-			
00h	1	01h	1/2																		
02h	1/3	03h	1/5																		
04h	1/10	05h	1/20																		
06h/07h	1/30	-	-																		



**REGISTER DESCRIPTION (continued)**

Register 02h							
Bit[7] (R/W)	Bit[6] (R/W)	Bit[5] (R/W)	Bit[4] (R/W)	Bit[3] (R/W)	Bit[2] (R/W)	Bit[1] (R/W)	Bit[0] (R/W)
SW1RSR1	SW1RSR0	SW1FSR1	SW1FSR0	SW2RSR1	SW2RSR0	SW2FSR1	SW2FSR0
Bit Field Definitions							
Bits	Field Name	Description					
[7:6]	SW1RSR [1:0]	These bits control the switching rising slew rate for SW1. 00h: 1V/ns 01h: 2V/ns 02h: Reserved 03h: Reserved					
[5:4]	SW1FSR [1:0]	These bits control the switching falling slew rate for SW1. 00h: 1V/ns 01h: 2V/ns 02h: Reserved 03h: Reserved					
[3:2]	SW2RSR [1:0]	These bits control the switching rising slew rate for SW2. 00h: 1V/ns 01h: 2V/ns 02h: Reserved 03h: Reserved					
[1:0]	SW2FSR [1:0]	These bits control the switching falling slew rate for SW2. 00h: 1V/ns 01h: 2V/ns 02h: Reserved 03h: Reserved					

Register 03h							
Bit[7] (R/W)	Bit[6] (R/W)	Bit[5] (R/W)	Bit[4] (R/W)	Bit[3] (R/W)	Bit[2] (R/W)	Bit[1] (R/W)	Bit[0] (R/W)
SYNC1	SYNC0	FSW5	FSW4	FSW3	FSW2	FSW1	FSW0
Bit Field Definitions							
Bits	Field Name	Description					
[7:6]	SYNC[1:0]	Sets the synchronization mode. 00h: Disable 01h: Synchronization clock input 02h: Synchronization clock output (with 0° phase shift) 03h: Synchronization clock output (with 180° phase shift)					
[5:0]	FSW[5:0]	Sets the switching frequency of the converter. Although FSW[5:0] can be set up to 2.2MHz, the maximum $f_{sw}$ supported by MPQ8875A is 1MHz. 00h to 03h: Reserved 04h to 2Ch: $f_{sw} = FSW[5:0] \times 50\text{kHz}$ (resolution: 50kHz) 2Dh to 3Fh: $f_{sw} = 2.2\text{MHz}$					

**REGISTER DESCRIPTION (continued)**

Register 04h																							
Bit[7] (R/W)	Bit[6] (R/W)	Bit[5] (R/W)	Bit[4] (R/W)	Bit[3]	Bit[2] (R/W)	Bit[1] (R/W)	Bit[0] (R/W)																
FSSSEN	FSSMR2	FSSMR1	FSSMR0	RESERVED	FSSMC2	FSSMC1	FSSMC0																
Bit Field Definitions																							
Bits	Field Name	Description																					
7	FSSSEN	This bit controls frequency spread spectrum (FSS). 0: Disabled 1: Enabled																					
[6:4]	FSSMR[2:0]	Sets the FSS modulation range (in 1% x f <sub>sw</sub> ). <table border="1" data-bbox="488 598 1161 766"> <tr> <td><b>00h</b></td> <td>±30</td> <td><b>01h</b></td> <td>±50</td> </tr> <tr> <td><b>02h</b></td> <td>±100</td> <td><b>03h</b></td> <td>±125</td> </tr> <tr> <td><b>04h</b></td> <td>±200</td> <td><b>05h</b></td> <td>Reserved</td> </tr> <tr> <td><b>06h/ 07h</b></td> <td>±300</td> <td>-</td> <td>-</td> </tr> </table> For example, if FSSMR[2:0] = 02h and the switching frequency is configured to 450kHz, FSS mode modulates the oscillator between 405kHz and 495kHz (±10% x f <sub>sw</sub> ).						<b>00h</b>	±30	<b>01h</b>	±50	<b>02h</b>	±100	<b>03h</b>	±125	<b>04h</b>	±200	<b>05h</b>	Reserved	<b>06h/ 07h</b>	±300	-	-
<b>00h</b>	±30	<b>01h</b>	±50																				
<b>02h</b>	±100	<b>03h</b>	±125																				
<b>04h</b>	±200	<b>05h</b>	Reserved																				
<b>06h/ 07h</b>	±300	-	-																				
3	RESERVED	Reserved.																					
[2:0]	FSSMC[2:0]	Sets the FSS modulation frequency (in Hz). <table border="1" data-bbox="488 955 1050 1094"> <tr> <td><b>00h</b></td> <td>250</td> <td><b>01h</b></td> <td>600</td> </tr> <tr> <td><b>02h</b></td> <td>1000</td> <td><b>03h</b></td> <td>1900</td> </tr> <tr> <td><b>04h</b></td> <td>2800</td> <td><b>05h</b></td> <td>3600</td> </tr> <tr> <td><b>06h</b></td> <td>7000</td> <td><b>07h</b></td> <td>8000</td> </tr> </table>						<b>00h</b>	250	<b>01h</b>	600	<b>02h</b>	1000	<b>03h</b>	1900	<b>04h</b>	2800	<b>05h</b>	3600	<b>06h</b>	7000	<b>07h</b>	8000
<b>00h</b>	250	<b>01h</b>	600																				
<b>02h</b>	1000	<b>03h</b>	1900																				
<b>04h</b>	2800	<b>05h</b>	3600																				
<b>06h</b>	7000	<b>07h</b>	8000																				

**REGISTER DESCRIPTION (continued)**

Register 05h																							
Bit[7] (R/W)	Bit[6] (R/W)	Bit[5] (R/W)	Bit[4] (R/W)	Bit[3] (R/W)	Bit[2] (R/W)	Bit[1] (R/W)	Bit[0] (R/W)																
CCMEN	RVCLMT	VLCLMT2	VLCLMT1	VLCLMT0	PKCLMT2	PKCLMT1	PKCLMT0																
Bit Field Definitions																							
Bits	Field Name	Description																					
7	CCMEN	Selects DCM or FCCM operation. 0: DCM 1: FCCM																					
6	RVCLMT	Sets the reverse current limit of the synchronous rectifier MOSFET (in A). The reverse current limit is disabled in DCM. 0: -2.5A 1: -4.7A																					
[5:3]	VLCLMT[2:0]	Sets the valley current limit (in A). <table border="1" data-bbox="488 747 1049 886"> <tr> <td>00h</td> <td>1</td> <td>01h</td> <td>2</td> </tr> <tr> <td>02h</td> <td>3</td> <td>03h</td> <td>4</td> </tr> <tr> <td>04h</td> <td>5</td> <td>05h</td> <td>6</td> </tr> <tr> <td>06h</td> <td>7</td> <td>07h</td> <td>8</td> </tr> </table> If the valley current limit set value exceeds the peak current limit, the valley current limit is invalid.						00h	1	01h	2	02h	3	03h	4	04h	5	05h	6	06h	7	07h	8
00h	1	01h	2																				
02h	3	03h	4																				
04h	5	05h	6																				
06h	7	07h	8																				
[2:0]	PKCLMT[2:0]	Sets the peak current limit (in A). <table border="1" data-bbox="488 1024 1049 1163"> <tr> <td>00h</td> <td>2</td> <td>01h</td> <td>3</td> </tr> <tr> <td>02h</td> <td>4</td> <td>03h</td> <td>5</td> </tr> <tr> <td>04h</td> <td>6</td> <td>05h</td> <td>7</td> </tr> <tr> <td>06h</td> <td>8</td> <td>07h</td> <td>9</td> </tr> </table>						00h	2	01h	3	02h	4	03h	5	04h	6	05h	7	06h	8	07h	9
00h	2	01h	3																				
02h	4	03h	5																				
04h	6	05h	7																				
06h	8	07h	9																				

**REGISTER DESCRIPTION (continued)**

Register 06h																																																																							
Bit[7] (R/W)	Bit[6] (R/W)	Bit[5] (R/W)	Bit[4] (R/W)	Bit[3] (R/W)	Bit[2] (R/W)	Bit[1] (R/W)	Bit[0] (R/W)																																																																
RFB2	RFB1	RFB0	RCOMP4	RCOMP3	RCOMP2	RCOMP1	RCOMP0																																																																
Bit Field Definitions																																																																							
Bits	Field Name	Description																																																																					
[7:5]	RFB[2:0]	Selects R <sub>FB</sub> , calculated with the following equation: $R_{FB} = 50k\Omega + RFB[2:0] \times 30k\Omega$																																																																					
[4:0]	RCOMP[4:0]	Selects R <sub>COMP</sub> (in kΩ). <table border="1" style="width: 100%; border-collapse: collapse; text-align: center;"> <tbody> <tr><td>00h</td><td>50</td><td>01h</td><td>173</td></tr> <tr><td>02h</td><td>297</td><td>03h</td><td>420</td></tr> <tr><td>04h</td><td>544</td><td>05h</td><td>667</td></tr> <tr><td>06h</td><td>791</td><td>07h</td><td>914</td></tr> <tr><td>08h</td><td>1038</td><td>09h</td><td>1161</td></tr> <tr><td>0Ah</td><td>1284</td><td>0Bh</td><td>1408</td></tr> <tr><td>0Ch</td><td>1531</td><td>0Dh</td><td>1655</td></tr> <tr><td>0Eh</td><td>1778</td><td>0Fh</td><td>1902</td></tr> <tr><td>10h</td><td>2025</td><td>11h</td><td>2148</td></tr> <tr><td>12h</td><td>2272</td><td>13h</td><td>2395</td></tr> <tr><td>14h</td><td>2519</td><td>15h</td><td>2642</td></tr> <tr><td>16h</td><td>2766</td><td>17h</td><td>2889</td></tr> <tr><td>18h</td><td>3012</td><td>19h</td><td>3136</td></tr> <tr><td>1Ah</td><td>3259</td><td>1Bh</td><td>3383</td></tr> <tr><td>1Ch</td><td>3506</td><td>1Dh</td><td>3630</td></tr> <tr><td>1Eh</td><td>3753</td><td>1Fh</td><td>3877</td></tr> </tbody> </table>						00h	50	01h	173	02h	297	03h	420	04h	544	05h	667	06h	791	07h	914	08h	1038	09h	1161	0Ah	1284	0Bh	1408	0Ch	1531	0Dh	1655	0Eh	1778	0Fh	1902	10h	2025	11h	2148	12h	2272	13h	2395	14h	2519	15h	2642	16h	2766	17h	2889	18h	3012	19h	3136	1Ah	3259	1Bh	3383	1Ch	3506	1Dh	3630	1Eh	3753	1Fh	3877
00h	50	01h	173																																																																				
02h	297	03h	420																																																																				
04h	544	05h	667																																																																				
06h	791	07h	914																																																																				
08h	1038	09h	1161																																																																				
0Ah	1284	0Bh	1408																																																																				
0Ch	1531	0Dh	1655																																																																				
0Eh	1778	0Fh	1902																																																																				
10h	2025	11h	2148																																																																				
12h	2272	13h	2395																																																																				
14h	2519	15h	2642																																																																				
16h	2766	17h	2889																																																																				
18h	3012	19h	3136																																																																				
1Ah	3259	1Bh	3383																																																																				
1Ch	3506	1Dh	3630																																																																				
1Eh	3753	1Fh	3877																																																																				

Figure 26 shows MPQ8875A control loop compensation network. Use Figure 26 to set values for register 06h and 07h.

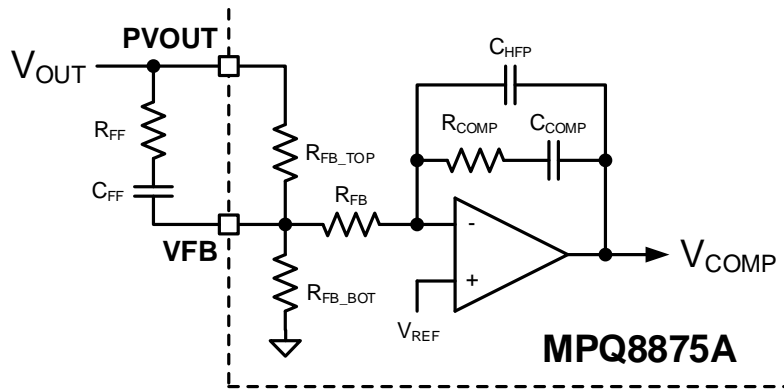

**Figure 26: Control Loop Compensation Network**

**REGISTER DESCRIPTION (continued)**

Register 07h							
Bit[7] (R/W)	Bit[6] (R/W)	Bit[5] (R/W)	Bit[4] (R/W)	Bit[3] (R/W)	Bit[2] (R/W)	Bit[1] (R/W)	Bit[0] (R/W)
CHFP2	CHFP1	CHFP0	CCOMP4	CCOMP3	CCOMP2	CCOMP1	CCOMP0
Bit Field Definitions							
Bits	Field Name	Description					
[7:5]	CHFP[2:0]	Selects CHFP (in pF).					
		00h	0.5	01h	1		
		02h	3	03h	5		
		04h	6	05h	8		
		06h	9	07h	10		
[4:0]	CCOMP[4:0]	Selects C <sub>COMP</sub> , which can be set between 5pF and 160pF. 00h to 1Fh: C <sub>COMP</sub> = (CCOMP[3:0] + 1) x 5pF					

Register 08h							
Bit[7] (R/W)	Bit[6] (R/W)	Bit[5] (R/W)	Bit[4] (R/W)	Bit[3] (R/W)	Bit[2] (R/W)	Bit[1] (R/W)	Bit[0] (R/W)
ADDR3	ADDR2	ADDR1	ADDR0	CYCEXTEN	RESERVED	BSTONT1	BSTONT0
Bit Field Definitions							
Bit#	Field Name	Description					
[7:4]	ADDR[3:0]	Sets the I <sup>2</sup> C bus address. The valid address is effective immediately once a write command is accepted.					
3	CYCEXTEN	This bit enables cycle extension in buck-boost mode. If this bit is enabled, the switching frequency is halved in buck-boost mode. 0: Disabled 1: Enabled					
2	RESERVED	Reserved.					
[1:0]	BSTONT[1:0]	Sets the constant-on-time percentage of the boost switch in buck-boost mode, which references to the switch's (Q3) duty cycle.					
		00h	20%	01h	30%		
		02h	40%	03h	50%		

**REGISTER DESCRIPTION (continued)**

Register 09h							
Bit[7] (R/W)	Bit[6] (R/W)	Bit[5] (R/W)	Bit[4] (R/W)	Bit[3] (R/W)	Bit[2] (R/W)	Bit[1] (R/W)	Bit[0] (R/W)
BKHYS1	BKHYS0	BKIN1	BKIN0	BSTHYS1	BSTHYS0	BSTOUT1	BSTOUT0
Bit Field Definitions							
Bits	Field Name	Description					
[7:6]	BKHYS[1:0]	Sets the transition hysteresis between buck and buck-boost mode. 00h: $V_{IN} = 5\%$ of $V_{OUT}$ 01h: $V_{IN} = 7.5\%$ of $V_{OUT}$ 02h: $V_{IN} = 10\%$ of $V_{OUT}$ (invalid when BKIN[1:0] is set to 00h) 03h: $V_{IN} = 12.5\%$ of $V_{OUT}$ (invalid when BKIN[1:0] is set to 00h)					
[5:4]	BKIN[1:0]	Sets the threshold at which buck-boost mode transitions to buck mode when $V_{IN}$ rises. 00h: $V_{IN} = 110\%$ of $V_{OUT}$ 01h: $V_{IN} = 120\%$ of $V_{OUT}$ 02h: $V_{IN} = 125\%$ of $V_{OUT}$ 03h: $V_{IN} = 130\%$ of $V_{OUT}$					
[3:2]	BSTHYS[1:0]	Sets the transition hysteresis between boost and buck-boost mode. 00h: $V_{IN} = 5\%$ of $V_{OUT}$ 01h: $V_{IN} = 7.5\%$ of $V_{OUT}$ 02h: $V_{IN} = 10\%$ of $V_{OUT}$ 03h: $V_{IN} = 12.5\%$ of $V_{OUT}$					
[1:0]	BSTOUT[1:0]	Sets the threshold at which boost mode transitions to buck-boost mode when $V_{IN}$ rises. 00h: $V_{IN} = 70\%$ of $V_{OUT}$ 01h: $V_{IN} = 80\%$ of $V_{OUT}$ 02h: $V_{IN} = 85\%$ of $V_{OUT}$ 03h: $V_{IN} = 90\%$ of $V_{OUT}$					

Figure 27 shows MPQ8875A regions of operation. Use Figure 27 to set the values for register 09h.

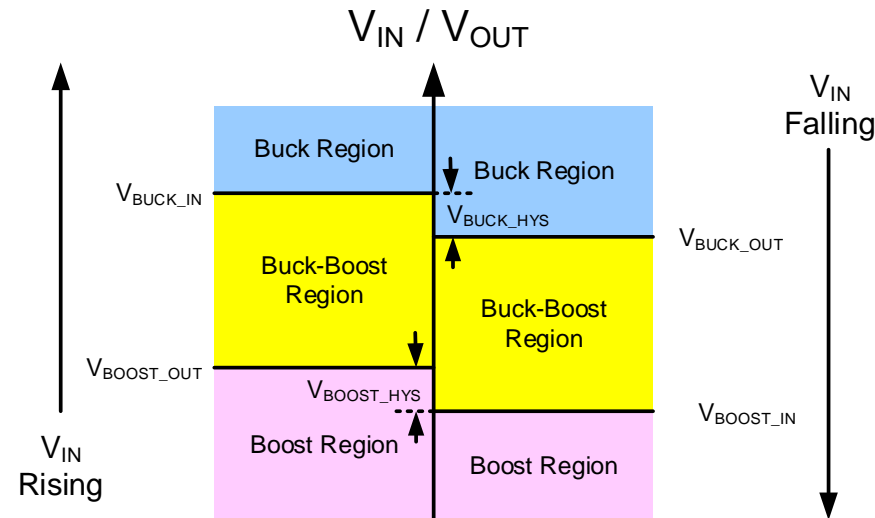

**Figure 27: Regions of Operation**

**REGISTER DESCRIPTION (continued)**

Register 0Ah							
Bit[7] (R/W)	Bit[6] (R/W)	Bit[5] (R/W)	Bit[4] (R/W)	Bit[3] (R/W)	Bit[2] (R/W)	Bit[1] (R/W)	Bit[0] (R/W)
ILGAIN	ILBIAS1	ILBIAS0	RAMPPV1	RAMPPV0	RAMP2	RAMP1	RAMP0
Bit Field Definitions							
Bits	Field Name	Description					
7	ILGAIN	Sets the gain for the inductor current sense. 0: 13A/V 1: 10.4A/V					
[6:5]	ILBIAS[1:0]	Sets the biased voltage for the inductor current sense (in mV).					
		<b>00h</b>	200	<b>01h</b>	260		
		<b>02h</b>	320	<b>03h</b>	380		
[4:3]	RAMPPV [1:0]	Sets the ramp compensation peak value to valley value (in mV).					
		<b>00h</b>	40	<b>01h</b>	60		
		<b>02h</b>	80	<b>03h</b>	100		
[2:0]	RAMP[2:0]	Sets the ramp compensation level (in mV/μs), calculated with the following equation: $\text{Ramp slope} = (f_{\text{sw}} \times 30) / (\text{RAMP}[2:0] + 1)$ Where $f_{\text{sw}}$ is the switching frequency (in MHz).					

**REGISTER DESCRIPTION (continued)**

Register 0Bh															
Bit[7] (R/W)	Bit[6] (R/W)	Bit[5] (R/W)	Bit[4] (R/W)	Bit[3] (R/W)	Bit[2] (R/W)	Bit[1] (R/W)	Bit[0] (R/W)								
PGVOHHYS	PGVOH	PGVOLHYS	PGVOL	OCCNT1	OCCNT0	OCPMD1	OCPMD0								
Bit Field Definitions															
Bits	Field Name	Description													
7	PGVOHHYS	Sets the power good high limit hysteresis. 0: 4% of V <sub>REF</sub> 1: 6% of V <sub>REF</sub>													
6	PGVOH	Sets the power good high limit (V <sub>OUT</sub> rising edge). 0: V <sub>FB</sub> = 112% of V <sub>REF</sub> 1: V <sub>FB</sub> = 117 of V <sub>REF</sub>													
5	PGVOLHYS	Sets the power good low limit hysteresis. 0: 4% of V <sub>REF</sub> 1: 6% of V <sub>REF</sub>													
4	PGVOL	Sets the power good low limit (V <sub>OUT</sub> falling edge). 0: V <sub>FB</sub> = 90% of V <sub>REF</sub> 1: V <sub>FB</sub> = 85% of V <sub>REF</sub>													
[3:2]	OCCNT[1:0]	Sets the over-current (OC) counter for an OC fault (in t <sub>sw</sub> , where t <sub>sw</sub> = 1/f <sub>sw</sub> ). <table border="1" style="margin-left: 20px;"> <tr> <td>00h</td> <td>32</td> <td>01h</td> <td>64</td> </tr> <tr> <td>02h</td> <td>128</td> <td>03h</td> <td>256</td> </tr> </table> The counter must count continuously. If the OC condition recovers while counting, the OC counter begins a recount. The OC counter is invalid during soft start, and the peak/valley current limit is valid.						00h	32	01h	64	02h	128	03h	256
00h	32	01h	64												
02h	128	03h	256												
[1:0]	OCPMD[1:0]	Selects the over-current protection (OCP) mode. 00h: Recoverable mode. If OCP is triggered, switching stops for some time (determined by the delay time set value). Then the part tries to soft start. If OCP is triggered again, the part enters hiccup mode 01h: Latch-off mode. If OCP is triggered, the part shuts down. The power on EN must be cycled to restart the part 02h or 03h: No response mode. The part keeps switching, and uses the peak/valley current limit unless over-temperature protection (OTP) occurs OCP mode selection is only valid when OCP is triggered. If under-voltage protection (UVP) and OCP are both triggered, UVP has a higher priority, and OCP is invalid. OCP is invalid during soft start, and the peak/valley current limit is valid.													



**REGISTER DESCRIPTION (continued)**

Register 0Ch															
Bit[7] (R/W)	Bit[6] (R/W)	Bit[5] (R/W)	Bit[4] (R/W)	Bit[3] (R/W)	Bit[2] (R/W)	Bit[1] (R/W)	Bit[0] (R/W)								
FLTMD	HCPTIME1	HCPTIME0	UVFB	UVCNT1	UVCNT0	UVPMD1	UVPMD0								
Bit Field Definitions															
Bits	Field Name	Description													
7	FLTMD	This bit selects the fault protection mode. 0: Auto-reset mode. Once the fault is removed, the fault bits in Register 0Fh reset after 30μs 1: Latch-off mode. The power on EN must be cycled to reset the fault bits													
[6:5]	HCPTIME [1:0]	Sets the delay time for fault recovery (in ms) <table border="1" data-bbox="488 600 1049 667"> <tr> <td>00h</td> <td>2</td> <td>01h</td> <td>4</td> </tr> <tr> <td>02h</td> <td>8</td> <td>03h</td> <td>16</td> </tr> </table> This is only valid in hiccup mode. All fault recoveries (e.g. OCP delay) must have a delay.						00h	2	01h	4	02h	8	03h	16
00h	2	01h	4												
02h	8	03h	16												
4	UVFB	Sets the value of V <sub>FB</sub> for under-voltage protection (UVP) (V <sub>OUT</sub> falling edge). 0: V <sub>FB</sub> = 50% of V <sub>REF</sub> 1: V <sub>FB</sub> = 75% of V <sub>REF</sub>													
[3:2]	UVCNT[1:0]	Sets the counter for under-voltage protection (UVP) (in t <sub>sw</sub> , where t <sub>sw</sub> = 1/f <sub>sw</sub> ). <table border="1" data-bbox="488 905 1049 972"> <tr> <td>00h</td> <td>2</td> <td>01h</td> <td>4</td> </tr> <tr> <td>02h</td> <td>8</td> <td>03h</td> <td>16</td> </tr> </table> The counter must count continuously. If the UV condition recovers while counting, the UV counter requires a recount. The UV counter should be shorter than the OC counter. UVP is invalid during soft start, and the peak/valley current limit is valid.						00h	2	01h	4	02h	8	03h	16
00h	2	01h	4												
02h	8	03h	16												
[1:0]	UVPMD[1:0]	Selects the UVP mode. 00h: Recoverable mode. If UVP is triggered, switching stops for some time (determined by the delay time set value). Then the part tries to soft start. If UVP is triggered again, the part enters hiccup mode 01h: Latch-off mode. If UVP is triggered, the part shuts down, and the power on EN must be cycled to restart the part 02h or 03h: No response mode. The part keeps switching, and uses the peak/valley current limit unless over-temperature protection (OTP) occurs OCP mode selection is only valid when OCP is triggered. If UVP and OCP are both triggered, UVP has a higher priority, and OCP is invalid.													

**REGISTER DESCRIPTION (continued)**

Register 0Dh															
Bit[7] (R/W)	Bit[6] (R/W)	Bit[5] (R/W)	Bit[4] (R/W)	Bit[3] (R/W)	Bit[2] (R/W)	Bit[1]	Bit[0] (R/W)								
VINOVHYS	VINOV1	VINOV0	VOUTOVHYS	VOUTOV1	VOUTOV0	ENFBO	OVPMD								
Bit Field Definitions															
Bits	Field Name	Description													
7	VINOVHYS	Sets the input voltage over-voltage (OV) hysteresis. 0: 3% of $V_{IN}$ 1: 5% of $V_{IN}$													
[6:5]	VINOV[1:0]	Sets the $V_{IN}$ OV threshold (rising edge) (in V). <table border="1" style="margin-left: 20px;"> <tr> <td>00h</td> <td>Disable</td> <td>01h</td> <td>11</td> </tr> <tr> <td>02h</td> <td>21</td> <td>03h</td> <td>33</td> </tr> </table>						00h	Disable	01h	11	02h	21	03h	33
00h	Disable	01h	11												
02h	21	03h	33												
4	VOUTOVHYS	Sets the $V_{OUT}$ OV recovery threshold. 0: 105% of $V_{REF}$ 1: 100% of $V_{REF}$													
[3:2]	VOUTOV [1:0]	Sets the $V_{OUT}$ OV threshold (rising edge) (in $V_{REF}$ ). <table border="1" style="margin-left: 20px;"> <tr> <td>00h</td> <td>110%</td> <td>01h</td> <td>115%</td> </tr> <tr> <td>02h</td> <td>120%</td> <td>03h</td> <td>130%</td> </tr> </table>						00h	110%	01h	115%	02h	120%	03h	130%
00h	110%	01h	115%												
02h	120%	03h	130%												
1	ENFBO	Selects the VFB pin connection mode. 0: Disconnected from the internal circuit 1: Connect VFB to the internal error amplifier's feedback input													
0	OVPMD	Selects the output over-voltage protection (OVP) mode. This bit is only valid for output OVP since input OVP recovers automatically. 0: Recoverable mode. If OVP is triggered, switching stops for a set time (determined by the delay time set value). Then the part tries to soft start. If OVP is triggered again, the part enters hiccup mode 1: Latch-off mode. If OVP is triggered, the part shuts down and the power on EN must be cycled before the part restarts													

**REGISTER DESCRIPTION (continued)**

Register 0Eh							
Bit[7]	Bit[6] (R)	Bit[5] (R)	Bit[4] (R)	Bit[3] (R/W)	Bit[2] (R/W)	Bit[1] (R/W)	Bit[0] (R/W)
RESERVED	TJ2	TJ1	TJ0	THSHYS1	THSHYS0	THSTEMP1	THSTEMP0
Bit Field Definitions							
Bits	Field Name	Description					
7	RESERVED	Reserved.					
[6:4]	TJ[2:0]	Sets the junction temperature (T <sub>J</sub> ) range (in °C). These bits are read-only.					
		<b>00h</b>	<25	<b>01h</b>	25 to 50		
		<b>02h</b>	50 to 75	<b>03h</b>	75 to 100		
		<b>04h</b>	100 to 125	<b>05h</b>	125 to 150		
		<b>06h</b>	150 to 160	<b>07h</b>	160 to 170		
[3:2]	THSHYS [1:0]	Sets the thermal shutdown (THS) hysteresis (in °C).					
		<b>00h</b>	25	<b>01h</b>	50		
		<b>02h/ 03h</b>	75	-	-		
[1:0]	THSTEMP [1:0]	Sets the THS T <sub>J</sub> threshold (rising edge) (in °C).					
		<b>00h</b>	150	<b>01h</b>	160		
		<b>02h/ 03h</b>	170	-	-		

**REGISTER DESCRIPTION (continued)**

Register 0Fh							
Bit[7] (R)	Bit[6] (R)	Bit[5] (R)	Bit[4] (R)	Bit[3] (R)	Bit[2] (R)	Bit[1] (R)	Bit[0] (R)
OTPCNT1	OTPCNT0	PGOOD	VINOVP	RESERVED	RESERVED	RESERVED	THS
Bit Field Definitions							
Bits	Field Name	Description					
[7:6]	OTPCNT [1:0]	These bits indicate the number of available one-time programmable (OTP) pages. These bits are read-only. 00h: 0 OTP pages available 01h: 1 OTP page available 02h: 2 OTP pages available 03h: 3 OTP pages available					
5	PGOOD	This bit indicates the power good status. This bit is read-only. 0: Power not good 1: Power good					
4	VINOVP	This bit indicates the V <sub>IN</sub> over-voltage (OV) status. This bit is read-only. 0: No V <sub>IN</sub> OV condition has occurred 1: A V <sub>IN</sub> OV condition has occurred					
[3:1]	RESERVED	Reserved.					
0	THS	This bit indicates the thermal shutdown (THS) status. This bit is read-only. 0: No THS has occurred 1: THS has occurred					

Register 10h							
Bit[7] (R)	Bit[6] (R)	Bit[5] (R)	Bit[4] (R)	Bit[3] (R)	Bit[2] (R)	Bit[1] (R)	Bit[0] (R)
MFG4	MFG3	MFG2	MFG1	MFG0	REV2	REV1	REV0
Bit Field Definitions							
Bits	Field Name	Description					
[7:3]	MFG[4:0]	Manufacturer code. These bits are read-only.					
[2:0]	REV[2:0]	Silicon revision code. These bits are read-only.					

## APPLICATION INFORMATION

Figure 28 shows MPQ8875A typical application circuit.

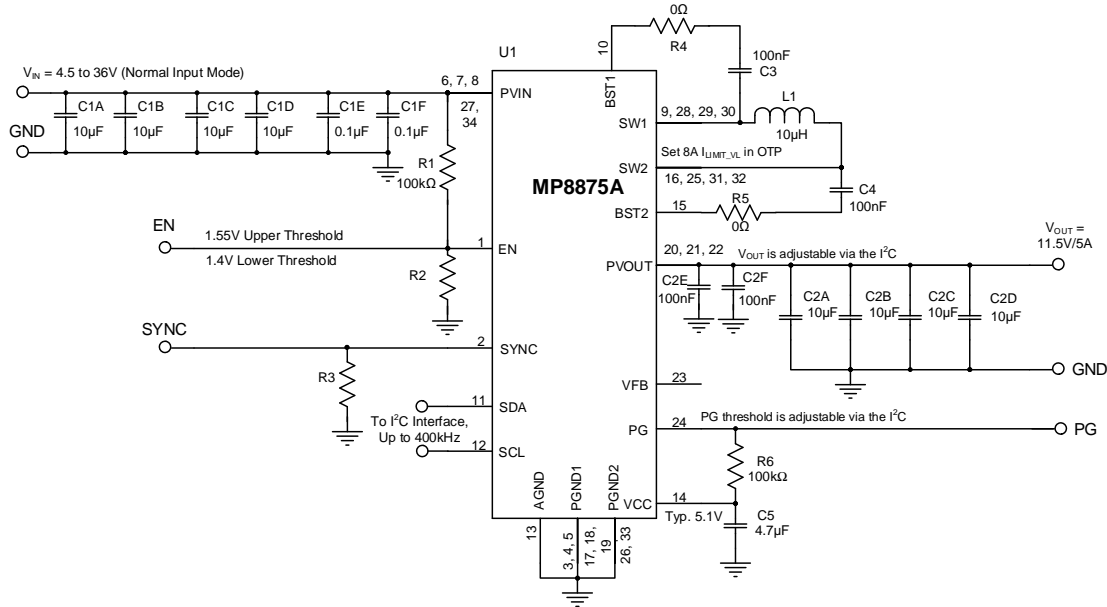

**Figure 28: Typical Application Circuit, V<sub>OUT</sub> = 11.5V, f<sub>sw</sub> = 450kHz**

Table 1 shows the design guide index. For more details, see Figure 28 above.

**Table 1: Design Guide Index**

Pin #	Name	Components	Design Guide Index
1	EN	R1	V <sub>IN</sub> Under-Voltage Lockout (UVLO) Setting (EN, Pin 1)
2	SYNC	-	Synchronization Input/Output (SYNC, Pin 2)
3, 4, 5	PGND1	-	GND Connection (PGND1, Pins 3, 4, and 5; AGND, Pin 13; PGND2, Pins 17, 18, 19, 26, and 33)
6, 7, 8, 27, 34	PVIN	C1A, C1B, C1C, C1D, C1E, C1F	Selecting the Input Capacitors (PVIN, Pins 6, 7, 8, 27, and 34)
9, 28, 29, 30	SW1	L1	Selecting the Inductor (SW1, Pins 9, 28, 29, and 30; SW2, Pins 16, 25, 31, and 32)
10	BST1	C3	Floating Driver and Bootstrap Charging (BST1, Pin 10; BST2, Pin 15)
11	SDA	-	I <sup>2</sup> C Interface (SDA, Pin 11; SCL, Pin 12)
12	SCL	-	I <sup>2</sup> C Interface (SDA, Pin 11; SCL, Pin 12)
13	AGND	-	GND Connection (PGND1, Pins 3, 4, 5; AGND, Pin 13; PGND2, Pins 17, 18, 19, 26, and 33)
14	VCC	C5	Pin 14 VCC, Internal VCC
15	BST2	C4	Floating Driver and Bootstrap Charging (BST1, Pin 10; BST2, Pin 15)
16, 25, 31, 32	SW2	L1	Selecting the Inductor (SW1, Pins 9, 28, 29, and 30; SW2, Pins 16, 25, 31, and 32)
17, 18, 19, 26, 33	PGND2	-	GND Connection (PGND1, Pins 3, 4, and 5; AGND, Pin 13; PGND2, Pins 17, 18, 19, 26, and 33)
20, 21, 22	PVOUT	C2A, C2B, C2C, C2D, C2E, C2F	Selecting the Output Capacitors (PVOUT, Pins 20, 21, and 22)
23	VFB	-	Internal VCC (VCC, Pin 14)
24	PG	R2	Power Good Indicator (PG, Pin 24)

### V<sub>IN</sub> Under-Voltage Lockout (UVLO) Setting (EN, Pin 1)

#### Enabled by External Logic High/Low Signal

EN is a digital control pin that turns the regulator on and off. Drive EN above its 0.85V logic threshold to activate the VCC regulator. Once VCC exceeds its under-voltage lockout (UVLO) threshold, VCC begins powering the internal control circuitry, and the integrated EN comparator works. Drive EN above its upper system threshold (1.55V) to enable the converter and initiate soft start. If EN is pulled below the lower system threshold (1.4V), the converter stops switching. The VCC regulator and control circuitry continue working until EN is pulled below its logic threshold (<0.5V).

Since EN has a 1MΩ pull-down resistor, float EN to shut down the chip. EN can be connected to a high-voltage bus (e.g. the PVIN pin) through a pull-up resistor. EN's maximum sink current is about 400μA, and it is recommended to use a 100kΩ pull-up resistor.

#### Configurable V<sub>IN</sub> Under-Voltage Lockout (UVLO) Threshold

The MPQ8875A has an internal, fixed under-voltage lockout (UVLO) threshold. In the normal input range, the rising threshold is about 3.6V, while the falling threshold is about 3.35V. For applications that require a higher UVLO point, place an external resistor divider between the PVIN and EN pins to raise the equivalent UVLO threshold (see Figure 29).

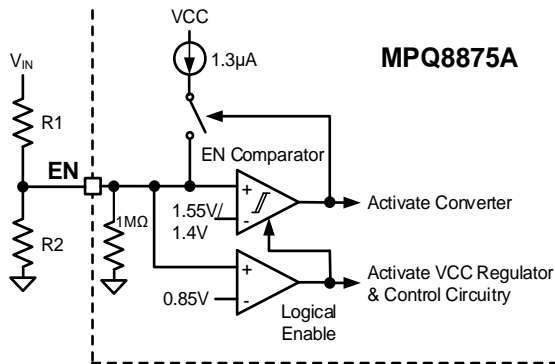

**Figure 29: Adjustable UVLO Using EN Divider**

The UVLO rising and falling thresholds can be calculated with Equation (12) and Equation (13), respectively:

$$V_{IN\_R} = \left( 1 + \frac{R_1}{R_2 \parallel 1M\Omega} \right) \times V_{EN\_R} \quad (12)$$

$$V_{IN\_F} = \left( 1 + \frac{R_1}{R_2 \parallel 1M\Omega} \right) \times V_{EN\_F} - 1.3\mu A \times R_1 \quad (13)$$

Where  $V_{EN\_R} = 1.55V$ , and  $V_{EN\_F} = 1.4V$ .

#### Synchronization Input/Output (SYNC, Pin 2)

The SYNC pin can be configured to synchronized input mode, synchronized output mode, or no response mode by Reg03h, bits[7:6]. If the SYNC pin is not used, float SYNC or pull it down to GND via a resistor (e.g. 100kΩ).

If synchronized input mode is enabled, the synchronization clock frequency ranges between 250kHz and 1MHz, and it must be 20% greater than the configured frequency set in the OTP register. The square-wave amplitude should have a peak above 1.4V, and a valley below 0.5V. The width of the synchronization pulse should exceed 200ns.

If synchronized output mode is enabled, the MPQ8875A can output the internal clock with a 0° or 180° phase shift. The output synchronization clock's duty cycle is constant at 50%.

#### Selecting the Input Capacitors (PVIN, Pins 6, 7, 8, 27, and 34)

The converter has a discontinuous input current when it operates in buck and buck-boost mode, and requires a capacitor to supply AC current to the converter while maintaining the DC input voltage. For the best performance, use low-ESR capacitors. Ceramic capacitors with X5R or X7R dielectrics are highly recommended because of their low ESR and small temperature coefficients.

It is strongly recommended to use two other, lower-value capacitors (e.g. 0.1μF) with a small package size (0603) to absorb high-frequency switching noise. Place the small-sized capacitor as close to PVIN and GND as possible. Place two bypass capacitors on pins 6, 8, and 27.

Since C<sub>IN</sub> absorbs the input switching current, it requires an adequate ripple current rating.

The RMS current in the input capacitor for buck mode and buck-boost mode can be estimated with Equation (14) and Equation (15), respectively:

$$I_{CINRMS\_BUCK} = I_{LOAD} \times \sqrt{\frac{V_{OUT}}{V_{IN}} \times \left(1 - \frac{V_{OUT}}{V_{IN}}\right)} \quad (14)$$

$$I_{CINRMS\_BUCK-BOOST} = I_{LOAD} \times \sqrt{\frac{V_{OUT}}{V_{IN}} \times \left(\frac{1}{1-D_{Q3}} - \frac{V_{OUT}}{V_{IN}}\right)} \quad (15)$$

Where  $D_{Q3}$  is the Q3 switch duty cycle.  $D_{Q3}$  is a fixed value set in register 08h.

The maximum RMS current for buck mode and buck-boost mode can be calculated with Equation (16) and Equation (17), respectively:

$$I_{CINRMS\_BUCK\_MAX} = \frac{I_{LOAD}}{2} \quad (16)$$

$$I_{CINRMS\_BUCK-BOOST\_MAX} = \frac{I_{LOAD}}{2 \times \sqrt{1-D_{Q3}}} \quad (17)$$

For simplification, choose an input capacitor with an RMS current rating greater than three fourths of the maximum load current.

The input capacitor can be electrolytic, tantalum, or ceramic. When using electrolytic or tantalum capacitors, add a small, high-quality ceramic capacitor (e.g. 0.1 $\mu$ F) as close to the IC as possible. When using ceramic capacitors, ensure that they have enough capacitance to provide a sufficient charge to prevent excessive voltage ripple at the input. The input voltage ripple caused by the capacitance for buck mode and buck-boost mode can be estimated with Equation (18) and (19), respectively:

$$\Delta V_{IN\_BUCK} = \frac{I_{LOAD}}{f_{SW} \times C_{IN}} \times \frac{V_{OUT}}{V_{IN}} \times \left(1 - \frac{V_{OUT}}{V_{IN}}\right) \quad (18)$$

$$\Delta V_{IN\_BUCK-BOOST} = \frac{I_{LOAD}}{f_{SW} \times C_{IN}} \times \frac{V_{OUT}}{V_{IN}} \times \left(1 - \frac{V_{OUT}}{V_{IN}} \times (1-D_{Q3})\right) \quad (19)$$

### Selecting the Output Capacitors (P<sub>VOUT</sub>, Pins 20, 21, and 22)

The converter has a discontinuous output current in boost and buck-boost mode, and requires a capacitor to supply AC current to the load while maintaining the DC output voltage. Use ceramic, tantalum, or low-ESR electrolytic capacitors. The output capacitor's

characteristics also affect the regulator control system's stability. For the best results, use low-ESR capacitors to keep the output voltage ripple low. It is strongly recommended to use other, lower-value capacitors (e.g. 0.1 $\mu$ F) with a small package size (0603) to absorb high-frequency switching noise. Place the small-sized capacitors as close to the P<sub>VOUT</sub> and GND pins as possible.

For ceramic capacitors, the capacitance dominates the impedance at the switching frequency and causes the majority of the output voltage ripple. For simplification, the output voltage ripple for boost mode and buck-boost mode can be estimated with Equation (20) and Equation (21), respectively:

$$\Delta V_{OUT\_BOOST} = I_{LOAD} \times \frac{1 - \frac{V_{IN}}{V_{OUT}}}{f_{SW} \times C_{OUT}} \quad (20)$$

$$\Delta V_{OUT\_BUCK-BOOST} = I_{LOAD} \times \frac{D_{Q3}}{f_{SW} \times C_{OUT}} \quad (21)$$

Where  $D_{Q3}$  is the Q3 switch duty cycle.  $D_{Q3}$  is a fixed value set in register 08h.

For tantalum or electrolytic capacitors, the ESR dominates the impedance at the switching frequency. The output ripple for boost mode and buck-boost mode can be estimated with Equation (22) and Equation (23), respectively:

$$\Delta V_{OUT\_BOOST} = I_{LOAD} \times \left( \frac{1 - \frac{V_{IN}}{V_{OUT}}}{f_{SW} \times C_{OUT}} + \frac{V_{OUT}}{V_{IN}} \times R_{ESR} \right) \quad (22)$$

$$\Delta V_{OUT\_BUCK-BOOST} = I_{LOAD} \times \left( \frac{D_{Q3}}{f_{SW} \times C_{OUT}} + \frac{1}{1-D_{Q3}} \times R_{ESR} \right) \quad (23)$$

Since  $C_{OUT}$  absorbs the output switching current, it requires an adequate ripple current rating. The RMS current in the output capacitor for boost mode and buck-boost mode can be estimated with Equation (24) and Equation (25), respectively:

$$I_{COUTRMS\_BOOST} = I_{LOAD} \times \sqrt{\frac{V_{OUT}}{V_{IN}} - 1} \quad (24)$$

$$I_{COUTRMS\_BUCK-BOOST} = I_{LOAD} \times \sqrt{\frac{D_{Q3}}{1-D_{Q3}}} \quad (25)$$



### Selecting the Inductor (SW1, Pins 9, 28, 29, and 30; SW2, Pins 16, 25, 31, and 32)

Connect an inductor between SW1 and SW2. A 1μH to 10μH inductor with a DC current rating at least 25% greater than the maximum inductor current is recommended for most applications. For higher efficiency, choose an inductor with a lower DC resistance. A larger-value inductor results in less ripple current and a lower output ripple voltage; however, they also have a larger physical size, higher series resistance, and lower saturation current.

A good rule to determine the proper inductance value is to make the inductor ripple current approximately 30% of the maximum average inductor current. The inductance values for buck and boost can be calculated with Equation (26) and Equation (27), respectively:

$$L_{\text{BUCK}} = \frac{V_{\text{OUT}}}{f_{\text{SW}} \times \Delta I_L} \times \left(1 - \frac{V_{\text{OUT}}}{V_{\text{IN}}}\right) \quad (26)$$

$$L_{\text{BOOST}} = \frac{V_{\text{IN}} \times (V_{\text{OUT}} - V_{\text{IN}})}{V_{\text{OUT}} \times f_{\text{SW}} \times \Delta I_L} \quad (27)$$

The inductance value for buck-boost mode when  $V_{\text{IN}} \geq V_{\text{OUT}}$  can be calculated with Equation (28):

$$L_{\text{BUCK-BOOST}, V_{\text{IN}} \geq V_{\text{OUT}}} = \frac{V_{\text{OUT}}}{f_{\text{SW}} \times \Delta I_L} \times (1 - t_1 \times f_{\text{SW}}) \quad (28)$$

The inductance value for buck-boost mode when  $V_{\text{IN}} < V_{\text{OUT}}$  can be calculated with Equation (29):

$$L_{\text{BUCK-BOOST}, V_{\text{IN}} < V_{\text{OUT}}} = \frac{V_{\text{IN}}}{f_{\text{SW}} \times \Delta I_L} \times t_3 \times f_{\text{SW}} \quad (29)$$

Where  $\Delta I_L$  is the peak-to-peak inductor ripple current,  $t_1$  is the MOSFET Q1 turn-on time, and  $t_3$  is the MOSFET Q3 turn-on time.

Choose the largest calculated result from the above equations to use as the inductance value.

The MPQ8875A's internal peak current limit should be considered when selecting the power inductor. Select the inductor for the saturation current ( $I_{\text{SAT}}$ ) with a minimum value that exceeds the peak current limit, so that the inductor is never saturated.

### Floating Driver and Bootstrap Charging (BST1, Pin 10; BST2, Pin 15)

The BST1 and BST2 capacitors (C3 and C4) range between 0.1μF and 1μF. A 0.1μF ceramic capacitor with a 0603 package size is recommended for most applications.

Place a resistor in series with the BST capacitor to reduce the SW rising rate and voltage spikes. This enhances EMI performance and reduces voltage stress at a high  $V_{\text{IN}}$ . A greater resistance is better for switching spike reduction but compromises efficiency. A tradeoff should be made between EMI and efficiency.

### I<sup>2</sup>C Interface (SDA, Pin 11; SCL, Pin 12)

The MPQ8875A works as a slave-only device, which supports up to 400kbs of bidirectional data transfer in fast mode, adding flexibility to the power supply solution. Refer to the I<sup>2</sup>C Interface section on page 41 for details.

If the I<sup>2</sup>C interface is not used, it is recommended to connect these pins to the VCC pin through a resistor (e.g. 100kΩ).

### Internal VCC (VCC, Pin 14)

The VCC capacitor (C5) should be between 1μF and 10μF. Generally, a 2.2μF or 4.7μF ceramic capacitor is recommended.

Most of the internal circuitry is powered by the internal 5V VCC regulator. This regulator uses  $V_{\text{IN}}$  as its input and operates across the full  $V_{\text{IN}}$  range. When  $V_{\text{IN}}$  exceeds 5V, VCC is in full regulation and supplied by  $V_{\text{IN}}$ . When  $V_{\text{IN}}$  is below 5V, but  $V_{\text{OUT}}$  exceeds 5V, VCC is supplied by  $V_{\text{OUT}}$ , and regulates to about 4.85V. When both  $V_{\text{IN}}$  and  $V_{\text{OUT}}$  are below 5V, the VCC output drops.

### Setting the Output Voltage

The MPQ8875A does not require an external resistor divider to set the output voltage. The OTP registers 00h and 01h set the output voltage (see the Register Description section on page 44).

The MPQ8875A's  $V_{\text{REF}}$  is configured in register 00h, REF[7:0]. The  $V_{\text{OUT}}$  divider ratio is configured in register 01h, bits FBDR[2:0].  $V_{\text{OUT}}$  can be calculated with Equation (30):

$$V_{\text{OUT}} = \frac{\text{REF}[7:0] \times 10\text{mV}}{\text{FBDR}[2:0]} \quad (30)$$



For example, if REF[7:0] is set to 73h and FBDR[2:0] is set to 04h, then  $V_{OUT} = 115 \times 10\text{mV} / (1/10) = 11.5\text{V}$ .

### Setting the Feedback (VFB, Pin 23)

The VFB pin is disconnected from the internal circuit by default. Float VFB if it is not used.

VFB optimizes the converter's transient response. Set register 0Dh, bit[1] to 1, then VFB is connected to the tap of the internal FB resistor divider.

A Type III compensation network is comprised of the internal existing Type II compensation network and an external RC compensation network tied between the PVOOUT and VFB pins (see Figure 30). The external RC network value is based on the detailed application and internal Type II compensation set-up.

Even if VFB is enabled and connected to the internal EA,  $V_{OUT}$  can only be set by changing the I<sup>2</sup>C register, and cannot be set by adding an external resistor divider to the VFB pin. This is because the  $V_{OUT} / V_{FB}$  divider ratio changes after adding an external resistor divider. The MPQ8875A's converter mode transition, power good (PG), over-voltage protection (OVP), and under-voltage protection (UVP) functions are related to the FB divider ratio. If the ratio is changed externally, the MPQ8875A cannot operate normally.

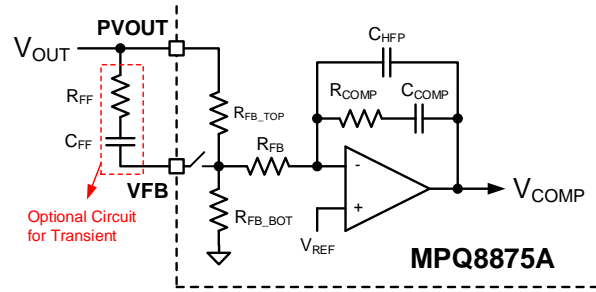

**Figure 30: Control Loop Compensation Network**

### Power Good Indicator (PG, Pin 24)

The  $R_{PG}$  resistance ( $R_2$ ) value is recommended to be about 100k $\Omega$ .

The PG pin is connected to the open drain of an internal MOSFET. It should also be connected to a voltage source through an external pull-up resistor for power good indication. The PG pin is pulled down to ground during soft start, or if  $V_{OUT}$  is not within the allowable window. The PG threshold and hysteresis can be programmed via the I<sup>2</sup>C interface.

Float PG if it is not used.

### GND Connection (PGND1, Pins 3, 4, and 5; AGND, Pin 13; PGND2, Pins 17, 18, 19, 26, and 33)

See the PCB Layout Guidelines section on page 62 for more details.

### PCB Layout Guidelines <sup>(12)</sup>

Efficient PCB layout (especially for input capacitor placement) is critical for stable operation. A 4-layer layout is strongly recommended to improve thermal performance. For the best results, refer to Figure 31 and follow the guidelines below:

1. Place symmetric input/output capacitors as close as possible to the PVIN and GND pins.
2. Use a large ground plane to connect directly to PGND. If the bottom layer is a ground plane, add vias near PGND.
3. Ensure that the high-current paths (e.g. PGND and PVIN/PVOUT) have short, direct, and wide traces.
4. Place the ceramic input capacitor, especially the small package size (0603) input/output bypass capacitor, as close as possible to the PVIN/PVOUT and PGND pins to minimize high-frequency noise.
5. Keep the connection between the input/output capacitor and PVIN/PVOUT as short and wide as possible.
6. Place a bypass capacitor close to pins 6 and 8 (PVIN), pin 27 (PVIN), and all PVOOUT pins.
7. Place the VCC capacitor as close to the VCC and GND pins as possible.
8. Route SW and BST away from sensitive analog areas, such as FB.
9. Use multiple vias to connect the power planes to the internal layers.

**Note:**

12) The recommended PCB layout is based on the typical application circuit (see Figure 32 on page 63).

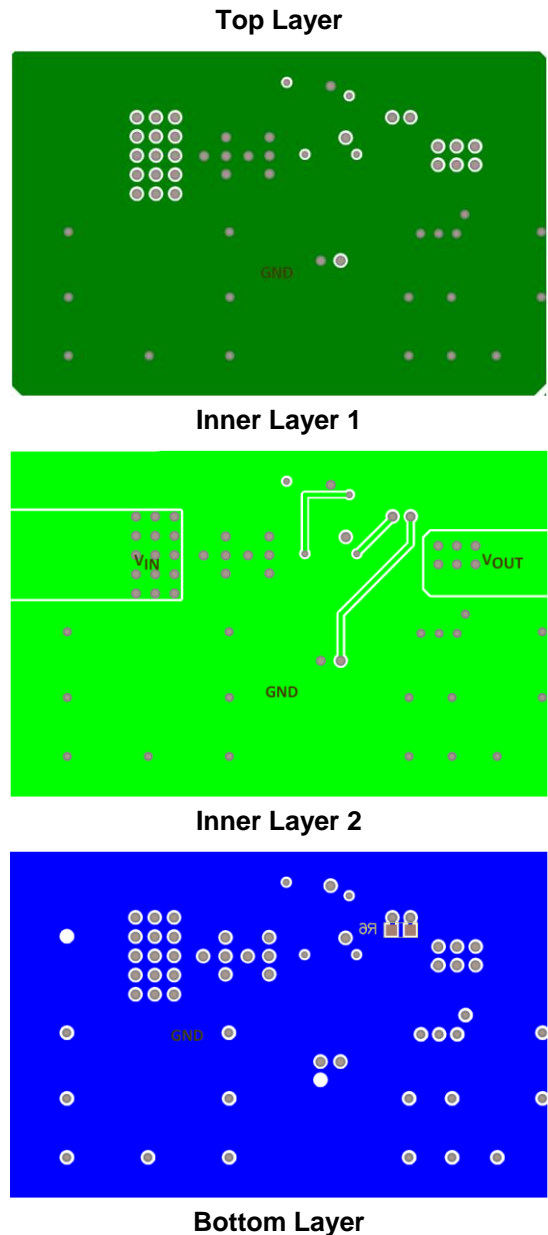

**Figure 31: Recommended PCB Layout**

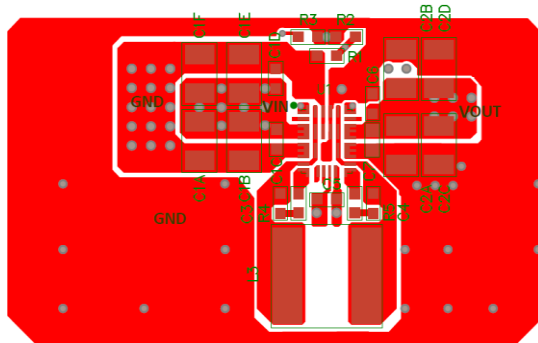

## TYPICAL APPLICATION CIRCUITS

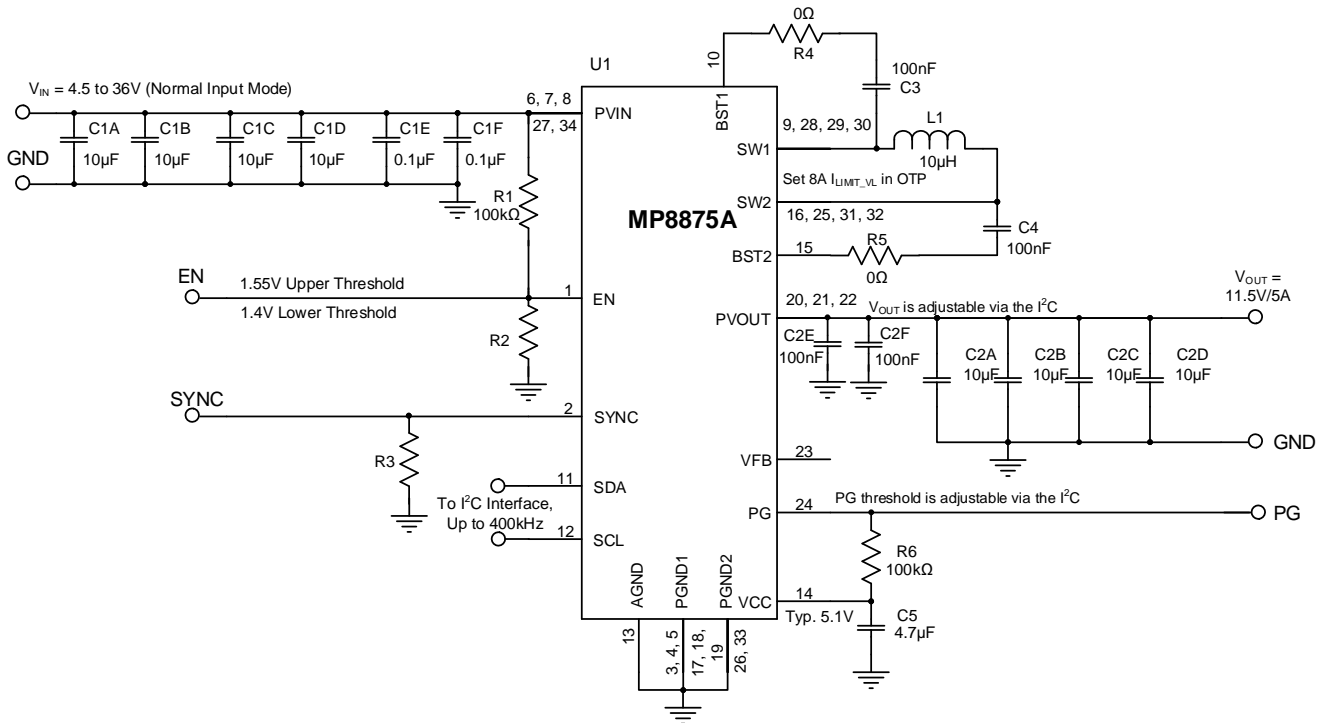

Figure 32:  $V_{OUT} = 11.5V$ ,  $f_{sw} = 450kHz$

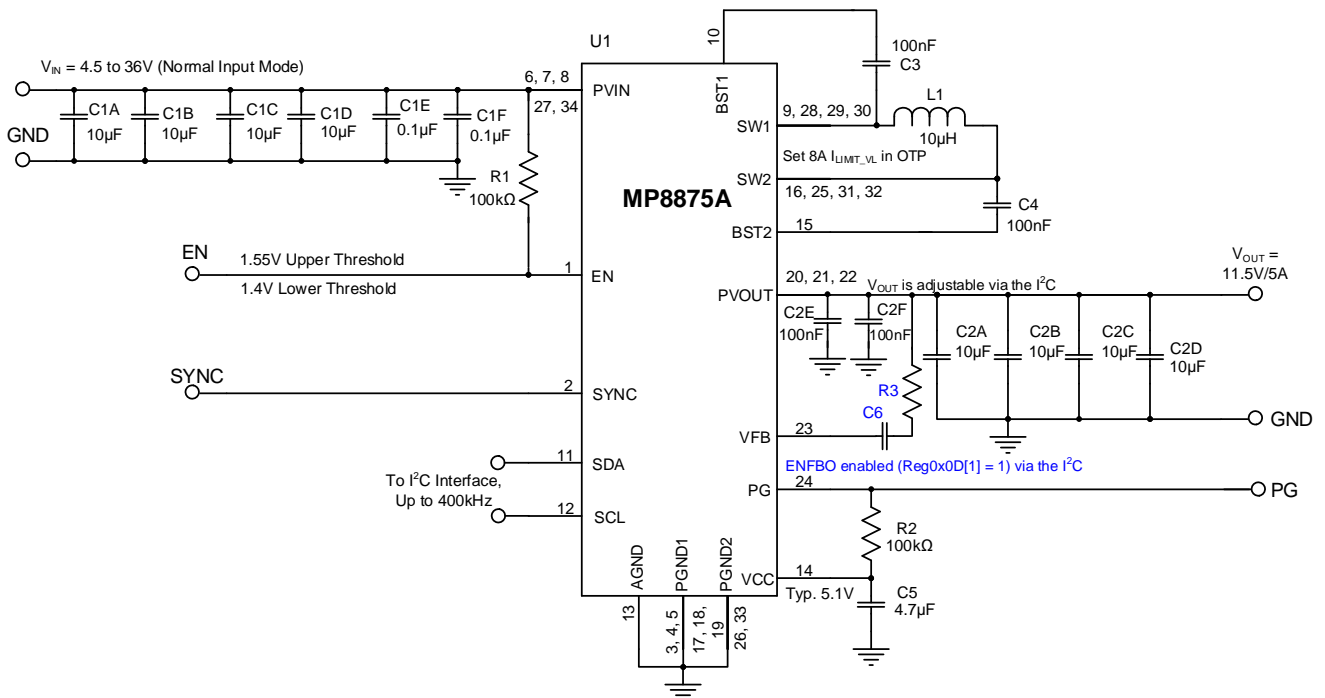

Figure 33:  $V_{OUT} = 11.5V$ ,  $f_{sw} = 450kHz$  with External Forward RC Compensation

TYPICAL APPLICATION CIRCUITS (continued)

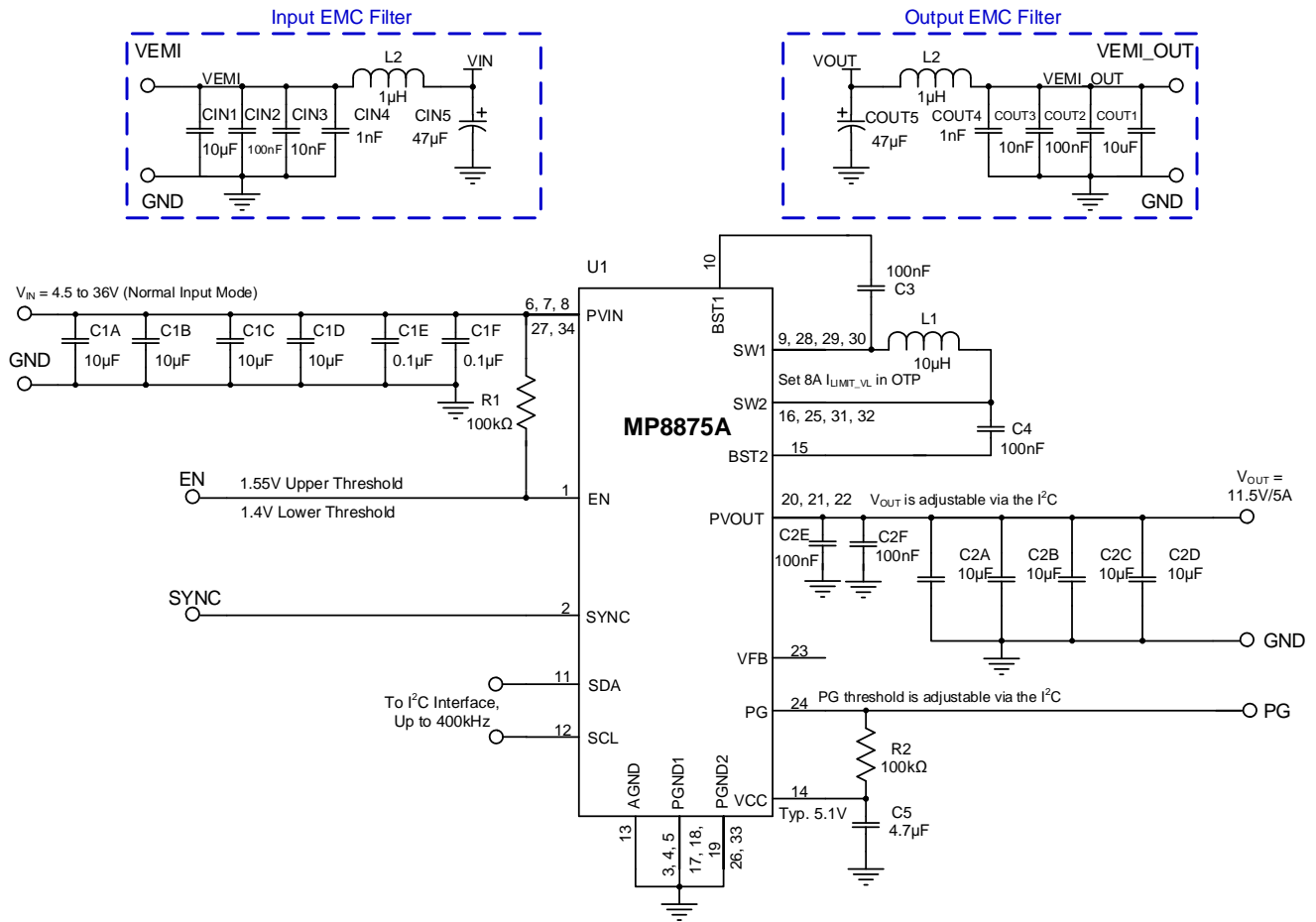
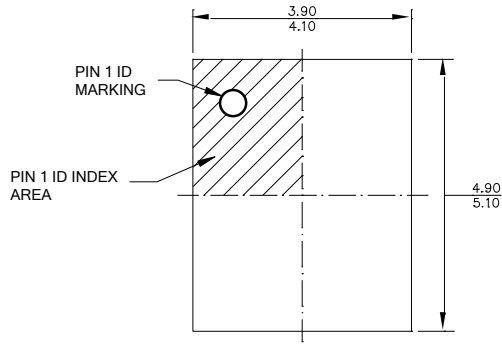

Figure 34: V<sub>OUT</sub> = 11.5V, f<sub>sw</sub> = 450kHz, with EMI Filters

# PACKAGE INFORMATION

## QFN-34 (4mmx5mm) Wettable Flank



TOP VIEW

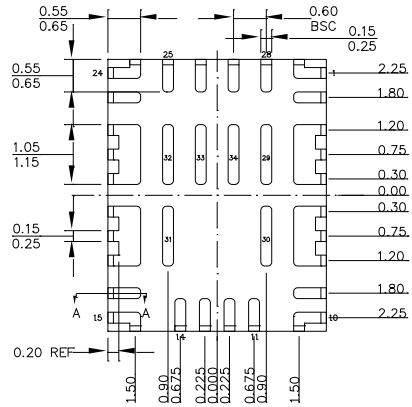

BOTTOM VIEW

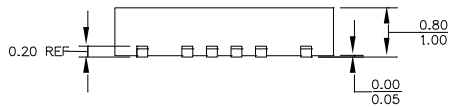

SIDE VIEW

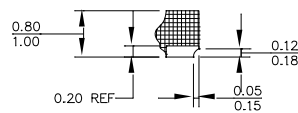

SECTION A-A

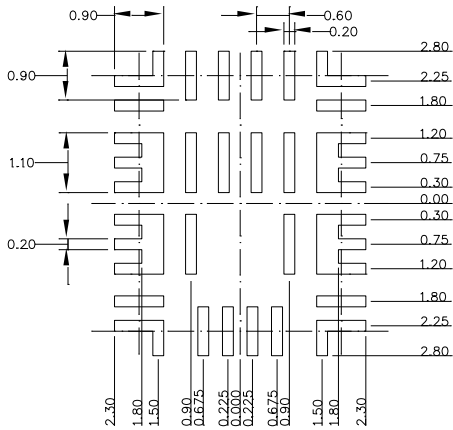

RECOMMENDED LAND PATTERN

**NOTE:**

- 1) ALL DIMENSIONS ARE IN MILLIMETERS.
- 2) LEAD COPLANARITY SHALL BE 0.08 MILLIMETERS MAX.
- 3) JEDEC REFERENCE IS MO-220.
- 4) DRAWING IS NOT TO SCALE.

### CARRIER INFORMATION

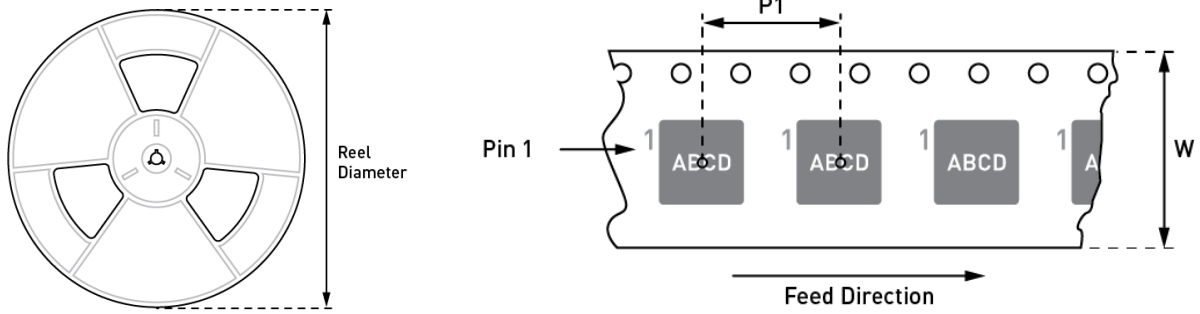

Part Number	Package Description	Quantity/ Reel	Reel Diameter	Carrier Tape Width	Carrier Tape Pitch
MPQ8875AGVE-xxxx-Z	QFN-34 (4mmx5mm)	5000	13in	12mm	8mm
MPQ8875AGVE-xxxx-AEC1-Z					

## REVISION HISTORY

Revision #	Revision Date	Description	Pages Updated
1.0	1/4/2021	Initial Release	-

**Notice:** The information in this document is subject to change without notice. Users should warrant and guarantee that third-party Intellectual Property rights are not infringed upon when integrating MPS products into any application. MPS will not assume any legal responsibility for any said applications.