

- CMOSens[®] technology
- Unbeatable price/performance ratio
- High output data speed (up to 200 Hz)
- Wide dynamic range (1:100 with 3% m.v. accuracy)
- Various maximum flow ranges: up to 200 l/min (FS)
- Digitally calibrated & temperature compensated
- RS232 interface
- RoHS compliant



v 3.0/ March 2009

CMOSens[®] EM1 Product Summary

The CMOSens[®] EM1 Mass Flow Meter (MFM) enables fast and economical measurement of gas flows over a very wide dynamic range. Its leading price/performance ratio is based on Sensirion's unsurpassed CMOSens[®] sensor technology which combines a sensor element with the amplification and A/D converter circuit on one single CMOS chip. This results in good performance, fast response time and large dynamic range at very attractive cost. All measurement data is fully calibrated and temperature compensated by means of an internal micro controller.

Mounted in rugged, chemically inert housing the CMOSens[®] EM1 Mass Flow Meter is suitable for a wide range of applications. Such include mass flow metering for process control, medical applications and fuel cells.

The sensor housing provides two inlets for measuring the gas flow and withstands overpressures of 8 bar (116 psi).

The CMOSens[®] EM1 Mass Flow Meter requires a supply voltage of 7-18 Vdc and provides an RS232 electrical interface.

EM1 is RoHS compliant.

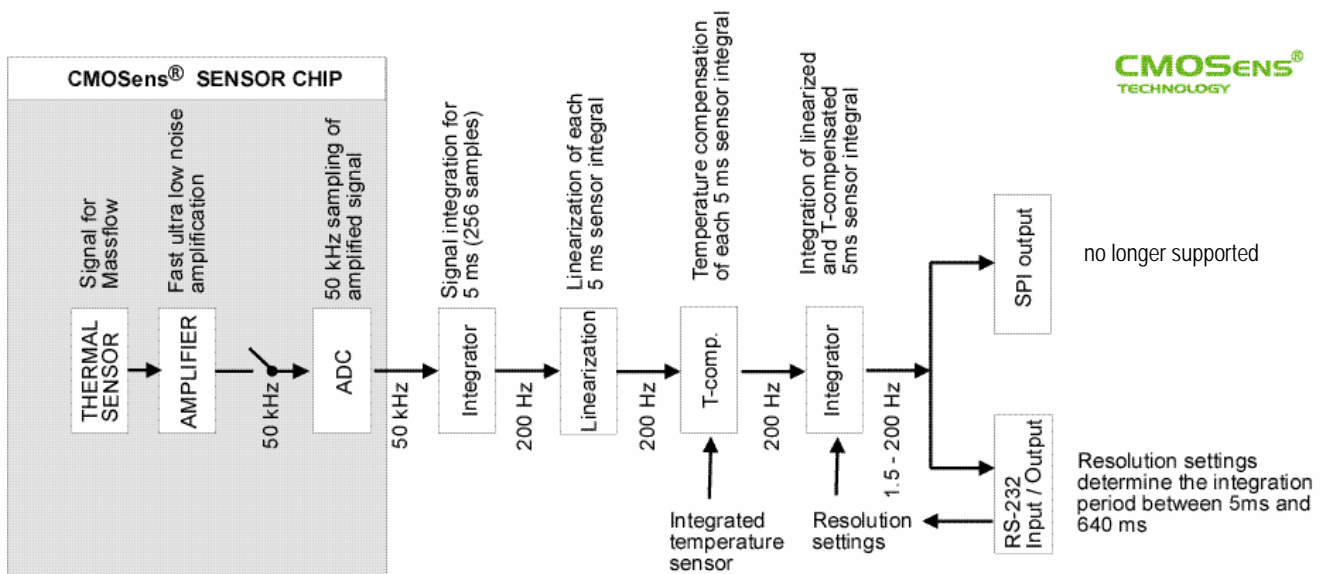

Figure 1: Block Diagram CMOSens[®] EM1 Mass Flow Meter.

Introductory Description

The heart of the CMOSens[®] Mass Flow Meter is powered by Sensirion's unsurpassed CMOSens[®] sensor technology. The CMOSens[®] EM1 Mass Flow Meter therefore provides unbeatable performance at very attractive system cost. One single device covers a range of 0.05 l/min up to 200 l/min .

The CMOSens[®] EM1 runs with an internal flow integration time of 5ms. This allows correct measurement and display of fast changing signals. But very often a precise total flow over a longer period is of higher interest than a fast single measurement. For this purpose the CMOSens[®] EM1 Mass Flow Meter can be set to slower read out times (see

Table 4). The sensor internally still integrates in 5 ms slices and recognizes fast signal changes but for the read out the total flow over the whole period is calculated. The CMOSens[®] Mass Flow Meter therefore is exceptionally well suited for difficult measurement conditions when fast changing gas flows must be monitored and summed up precisely.

The CMOSens[®] EM1 Mass Flow Meter measures true mass flow independent of the ambient temperature and pressure changes. You simply connect the gas to be measured to the CMOSens[®] EM1 device to get an instantaneous gas mass flow integral with a selectable integration time between 5 ms and 640 ms. Depending on the type a flow range between 0.1 l/min and up to 200 l/min can directly be measured by connecting the CMOSens[®] EM1 Mass Flow Meter.

In addition to mass flow, the CMOSens[®] EM1 device provides information about the temperature on the CMOSens[®] sensor element. Both mass flow and temperature data are accessed through an RS232 interface. The RS232 interface allows you to directly connect the CMOSens[®] EM1 Mass Flow Meter to a PC. If a special interface such as 4-20 mA current output or other or another flow range is required, contact Sensirion for a customer specific solution.

Please contact Sensirion before using any corrosive, toxic or explosive gas types (see also section 1.6 and 1.7). However, the standard calibration gas is nitrogen. Please contact Sensirion, if you would like to use the sensor for applications with other gases.

A free PC software to read out the CMOSens[®] EM1 Mass Flow Meter can be downloaded from www.sensirion.com.

CMOSens[®] sensor technology

CMOSens[®] is the base technology for all Sensirion multi sensor modules and sensor systems. The unification of semiconductor chip and sensor technology serves as a platform for highly integrated system solutions with excellent sensor precision and reliability. With CMOSens[®], the on-chip sensor element forms an integrated whole with a high-end amplification and A/D converter circuit. Due to the compact single-chip design, CMOSens[®] based sensors are very resistant to electromagnetic disturbances (EMC), another important technical advantage of this state of the art sensor technology. As a result, CMOSens[®] based multi sensor modules offer excellent sensor precision, fast response time and a very large dynamic measurement range. In addition, the digital intelligence of the CMOSens[®] sensor technology enables digital interfaces that permit an easy link with the system of the customer, a real advantage and benefit that results in ready-to-use problem solutions.

1 CMOSens® EM1 Mass Flow Meter Performance

Table 1: Specifications of EM1 Mass Flow Meter – low flow ranges.

All data unless otherwise noted apply for calib. cond: 20°C, N₂, 1013 mbar absolute pressure, horizontal mounting position, straight inlet fitting (length min. 5 x Ø)

Specification	Condition	Value		Unit
Model Number		EM1_H...	EM1_L...	
Flow Range ¹		0-0.05	0 – 0.5	l _n /min
Performance				
Accuracy ^{2,3}	2.5 - 100% FS ⁴		3.0	% m.v. ⁵
	<2.5 % FS		0.075	% FS.
	10 - 100% FS	5.0		% m.v.
	<10 % FS	0.5		% FS
Repeatability	2.5 - 100% FS		0.3	% m.v.
	<2.5 % FS		0.02	% FS
	10 - 100% FS	0.5		% m.v.
	<10 % FS	0.05		% FS
Offset		<0.5	< 0.1	% FS
Standard Calibration Gas ⁶		N ₂		
Dynamic Range		>= 1:100		
Operating Temperature Ambient/Gas		0 – 50 / 32 – 122		°C / °F
Temp. Coeff. Zero		0.01		%FS / °C
Temp. Coeff. Span		0.1		% m.v. / °C
Position Sensitivity correction	<5% FS	0.1		% FS
Pressure Coefficient		0.15% / bar – 0.01 % / psi		
Pressure Drop at Full Flow ⁷	straight inlet	<2 / 0.029	2 / 0.029	mbar / psi

Table 2: Specifications of EM1 Mass Flow Meter – medium and high flow ranges.

All data unless otherwise noted apply for calib. cond.: 20°C, N₂, 1013 mbar absolute pressure, horizontal mounting position, straight inlet fitting (length min. 5 x Ø)

Specification	Condition	Value		Unit
Model Number		EM1_R...	EM1_V...	
Flow Range ⁸		0 – 20	0 – 200	l _n /min
Performance				
Accuracy ^{9,10}	1 - 100% FS ¹¹	3	5	% m.v. ¹²
	<1 % FS	0.03	0.05	% FS
Repeatability	10-100% FS	0.3	0.5	% m.v.
	<10% FS	0.02	0.02	% FS
Offset		< 0.03	< 0.03	% FS
Standard Calibration Gas ¹³		Air		
Dynamic Range		>= 1:100		
Operating Temperature Ambient/Gas		0 – 50 / 32 – 122		°C / °F
Temp. Coeff. Zero		0.01		%FS / °C
Temp. Coeff. Span		0.1		% m.v. / °C
Position Sensitivity correction	<5% FS	0.1		% FS
Pressure Coefficient		0.15% / bar – 0.01 % / psi		
Pressure Drop at Full Flow ¹⁴	straight inlet	20 / 0.29	100 / 1.45	mbar / psi

¹ Other ranges for volume applications on request² Including Offset, Non-Linearity, Hysteresis³ Better accuracy available on request⁴ In % of full scale (FS)⁵ In % of measured value (m.v.) = of rate = of reading⁶ Other gases for volume applications on request⁷ All data for 1'013 mbar, 1 bar = 100 000 Pa = 401.9 inch H₂O = 14.5 psi. Lower pressure drop available for volume applications on request.⁸ Other ranges for volume applications on request⁹ Including Offset, Non-Linearity, Hysteresis¹⁰ Better accuracy available on request¹¹ In % of full scale (FS)¹² In % of measured value (m.v.) = of rate = of reading¹³ Other gases for volume applications on request¹⁴ All data for 1'013 mbar, 1 bar = 100 000 Pa = 401.9 inch H₂O = 14.5 psi. Lower pressure drop available for volume applications on request.

Table 3: Additional Specifications of EM1 Mass Flow Meter – all flow ranges.

Specification	Condition	Value	Unit
Temperature Sensor (measured media)			
Dynamic Range		0 – 60 / 32 – 140	°C / °F
Resolution		0.1	K
Accuracy		2	K
Electrical			
Output		RS 232	
Supply Voltage		+ 7 – + 18	VDC
Electrical Connector		Molex	
Mechanical			
Length		13.6 / 5.35	cm / inch
Width		4.4 / 1.73	cm / inch
Height		8.18 / 3.2	cm / inch
Weight (straight / angle connector)		165 / 105	g
Mechanical Connector		G 3/8	inch
Maximum Operating Pressure ¹		8 / 116	bar / psi
Burst Pressure		40 / 580	bar / psi
Leak-Integrity		1 x 10 e-4	mbar l/s He
Material			
Wetted Materials		Si, Si ₃ N ₄ , SiOx, Gold, Viton®, Epoxy, Glob Top, Polycarbonate	
RoHS / WEEE compliance		Yes.	

Table 4: CMOSens® EM1 Mass Flow Meter Resolution (EM1_V) at different Flow Levels and integration time.

Flow Level	Readout Frequency 200 Hz	Readout Frequency 50 Hz	Readout Frequency 12.5 Hz	Readout Frequency 1.56 Hz
Flow Level				
200 l/min	13 l/min	3.5 l/min	0.9 l/min	0.11 l/min
50 l/min	4.0 l/min	1.0 l/min	0.3 l/min	0.03 l/min
< 5 l/min	1.0 l/min	0.25 l/min	0.06 l/min	0.0143 l/min
Mass Flow Integration Time				
	5 ms	20 ms	80 ms	640 ms

¹ 12.0 bar / 174 psi for short time operation, higher values for volume applications on request

1.1 Gas Flow Characteristics

Figure 2 shows the applied gas flow vs. the digital output of the CMOSens[®] EM1 Mass Flow Meter for the 200 l/min version.

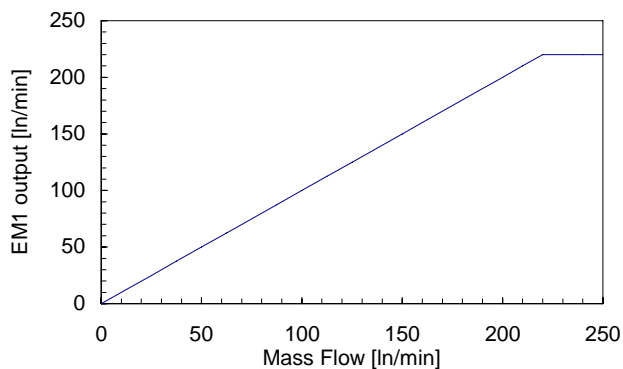

Figure 2: Typical CMOSens[®] EM1 Mass Flow Meter transfer characteristics.

The CMOSens[®] EM1 Mass Flow Meter is calibrated from 0 l/min up to a flow of 200 l/min (depending on the actual type). Between 200 l/min and 220 l/min flow is displayed, but with reduced accuracy. Two types of overflows are reported outside of this expanded range:

1. 'Peak Overflow' if the measured flow was only partly above i.e. 220 l/min. In this context it has to be remembered that the CMOSens[®] EM1 Mass Flow Meter averages the flow over a eligible integration time. It can be that the average flow is small but that it periodically exceeds the maximum of 220 l/min and no precise measurement of the average can be guaranteed anymore. This can be checked with a sensor readout at 200 Hz.
2. 'Overflow' if the measured flow is always above the limit of 220 l/min

1.2 Sensor Principle and Gas Types

The CMOSens[®] EM1 Mass Flow Meter detects mass gas flow by measuring heat transfer. A heating resistor on a thermally insulated membrane is kept above ambient temperature. In the presence of gas flow, the temperature distribution up- and downstream is disturbed. This asymmetry is then measured. Due to the minimal thermal mass of the membrane, symmetrical arrangement, and accurate temperature measurement, the very good specifications of the CMOSens[®] EM1 Mass Flow Meter are achieved.

The above mentioned thermal principle requires information about the gas type to be measured. The

CMOSens[®] EM1 is available for air and nitrogen. Other gas types are available on request.

In Figure 3 the repeatability of the CMOSens[®] EM1 devices is compared with the repeatability of a typical Mass Flow Controller (MFC). It emphasizes the superior performance of the CMOSens[®] EM1 Mass Flow Meter.

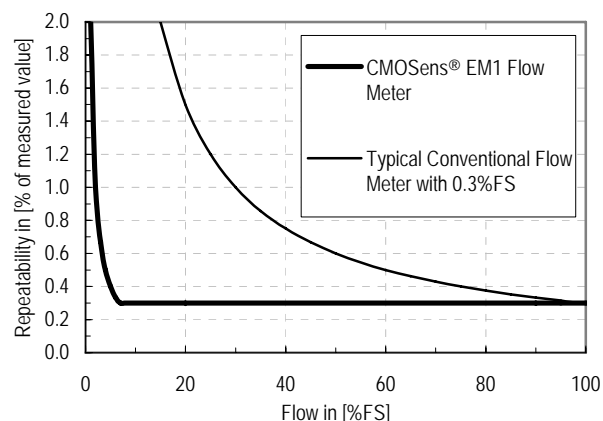

Figure 3: Comparison of the repeatability of the CMOSens[®] EM1 compared to a typical Mass Flow Controller (MFC).

1.3 Temperature Compensation

The CMOSens[®] EM1 Mass Flow Meter has an automatic temperature compensation implemented. The flow measurement must be suspended for the duration of each update of the temperature measurement. Since these interrupts of the flow measurement shall be short the temperature measurements are only done with a reduced accuracy. They can vary between different measurements and reduce the accuracy of the temperature compensated flow output. The duration of the temperature update is 45 ms which gives a variation of the output of the compensated flow by 0.1% of measured value (for N₂). Advanced users can choose duration and accuracy of the temperature updates and reduce the inaccuracy of the temperature compensation even more.

The moment of a temperature update can be controlled in two modes:

- a) Automatically
The temperature measurements are updated automatically in fixed periods which can be set by the command INT (see 0).
- b) By Hand
For highest accuracy it is recommended to set INT=0 and initiate the updates through the RS232 interface with UPDATETEMP (see 0). For such measurements it also makes sense to use the option for advanced users to set the

duration and accuracy of the temperature update to the maximum.

By default temperature updates are done automatically every 60 seconds (INT=12000).

1.4 Gas Flow and Pressure Difference

The CMOSens[®] EM1 is calibrated for mass flow measurement. However, there is a well defined relation between mass flow and pressure drop. This relation is shown in Figure 4.

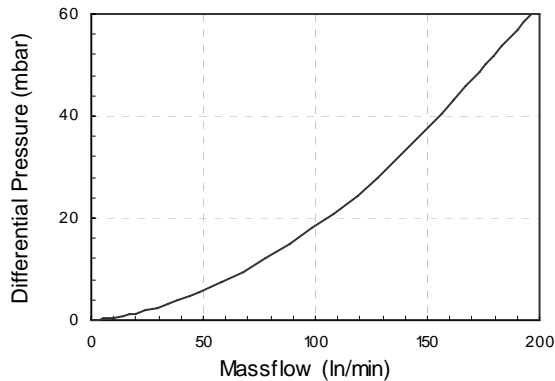

Figure 4: Differential Pressure vs. Mass Flow of CMOSens[®] EM1 Device.

Table 5: Overview of Wetted Materials

Part	Wetted Material
Body	Polycarbonate
Sensor element	Silicon (Si) Silicon oxide (SiO _x) Silicon nitride (Si ₃ N ₄) Glob Top Epoxy Gold
Sealing	Viton [®]

1.5 Wetted Materials & Compatibility

The construction ensures that a minimum number of materials is wetted by the gas which is measured by the CMOSens[®] EM1 Mass Flow Meter.

The following Table 5 gives an overview of the materials wetted by the gas.

1.6 Operation with different gas types

The CMOSens[®] EM1 mass flow sensor is available in different versions. For all versions the safety restrictions in chapter 1.7 must be observed.

For standard applications a cost effective Nitrogen (N₂) calibrated off the shelf version is the best choice. This also ensures short lead times at comparably low costs. For the use of these devices with other gases, detailed conversion functions are available. Please check also www.sensirion.com for further details.

For volume customers other gas type calibrations are available on request and availability. Please contact Sensirion for further details if this option is applicable to you.

1.7 Safety Restrictions

The packaging method of the CMOSens[®] chip together with the inert housing and the sealing materials ensure a tight and highly resistant sealing of the device. Please be aware that aggressive and corrosive gases can influence the sensor element and may even destroy the Viton[®] sealing or the polycarbonate body.

Please also be careful with the use of explosive or toxic gases. Any leakage even outside the controller can be dangerous. The CMOSens[®] sensor element is tested according to EN 50020 chapter 6.2.4 b) for the safe use of gases of class T4 or group 1 (as mixtures of air with hydrogen or hydrocarbons).

For the above reasons, Sensirion guarantees the safe use of the CMOSens[®] EM1 Mass Flow Meter for inert, in-explosive and non-toxic gases only.

2 Pins and Electrical Interfaces

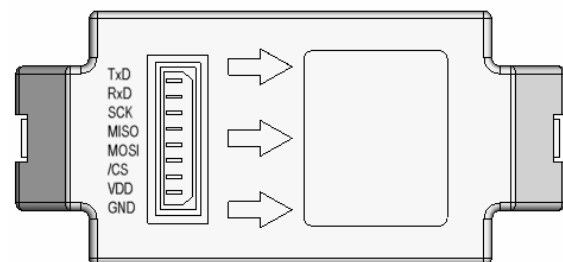

Figure 5: CMOSens[®] EM1 pin out.

2.1 Electrical Connector

The electrical connector on the cover of the CMOSens[®] EM1 is a Molex PN 53014-0810 (straight header, male, 8Pin). You need a Molex PN 51004-0800 connector housing (female, 8 Pin) with crimp contacts Molex PN 50011-8100 to connect the sensor. Please check the Molex homepage for details (<http://www.molex.com>).

2.2 Power supply

The CMOSens[®] EM1 Mass Flow Meter requires a voltage supply between 7V and 18 V. Since this voltage is internally regulated, there are no stringent requirements as far as ripple and stability are concerned.

2.3 Digital Interface

The CMOSens[®] EM1 Mass Flow Meter has a bidirectional RS232 to set configuration and to get flow or temperature values. The in earlier versions available SPI interface is no longer specified, due to changed specifications of electronic components. If you require the SPI functionality contact Sensirion.

2.4 Dataformat and Interpretation

The received value is a 16 bit signed integer in the two's complement representation. The calibrated data is multiplied by a constant factor and then rounded to the next smaller integer in order to transfer also fractions of a unit through the integer protocol.

Product	Flow scale factor	Temp. scale factor
EM1NH	1/100 ml _n /min	0.01 °C
EM1NL	1/50 ml _n /min	0.01 °C
EM1NR	1 ml _n /min	0.01 °C
EM1NV	1/128 l _n /min	0.01 °C

Example for EM1NV: a received value of +1234 (dec) corresponds either to 9.641 l_n/min in flow mode or 12.34 °C in temperature mode. An explanation of the overflow modes can be found in section 1.1.

received value (hex)	received value (dec)	flow [l _n /min]	temperature [°C]
0x7852	30802	overflow	--
0x7851	30801	peak overflow	--
0x7850	30800	+240.600	+308.00*
⋮	⋮	⋮	⋮
0x0001	1	+0.007813	0.01
0x0000	0	0.000000	0.00
0xFFFF	-1	-0.007813	-0.01
⋮	⋮	⋮	⋮
0x87B0	-30800	-240.600	-308.00*

*not possible value, just to show the principle

Figure 6: Interpretation of Integer values

2.5 RS232 Interface

All configurations (see also Section 3) for the CMOSens[®] EM1 can be set using its RS232 interface.

The following pins are required to communicate with the CMOSens[®] MFM via RS232:

RxD (Receiving Data Line)
TxD (Transmitting Data Line)
GND (Ground)

The RS232 protocol of the CMOSens[®] MFM is configured as follows:

Baudrate 19200
Data Bits 8
Stop Bits 1
Parity none
Protocol none
Echo the sensor generates an echo

With these settings, the CMOSens[®] EM1 device can be connected to any PC or device with an RS232 interface. The commands have to be sent in ASCII format, the measurement values are provided as a 16 bit signed integer in binary format with 2 bytes synchronization preceding.

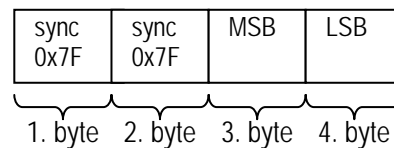

Figure 7: Byte sequence of one value

Because of the maximum range of 0x7852, the high byte never will contain 0x7F. Therefore the worst case is, if the lower byte contains 0x7F. In this special case, 0x7F appears three times in a row.

Example (val=7C 7F):

received string: 7F 7F 7C 7F 7F 7F 7C 7F
right sync: 7F 7F 7C 7F 7F 7F 7C 7F
wrong sync: 7F 7F 7F 7C

The best approach to find the sync in pseudo code:

if (buffer[i]=7F and buffer[i+1]=7F and buffer[i+2] <> 7F)
then buffer[i] and buffer[i+1] are sync bytes.

3 Configuration and Commands

3.1 Device Configuration

The CMOSens[®] EM1 device accepts a set of commands. They can only be sent through its RS232 interface (see Table 6 for valid commands; for correct settings of the RS232 refer to Section 2.1). This allows the user to configure the CMOSens[®] EM1 device. Since the configuration is stored in the internal EEPROM, it is maintained after power interruptions.

Table 6: RS232 Interface commands

With the exception of the stop *s* command, all commands have to be sent in the ASCII-format and terminated by the return key (\downarrow , ASCII #10 or #13). After completion of a command, the CMOSens[®] MFM returns *ok* and is ready to take a new instruction. Before entering a command, it may be necessary to clear the buffer by means of using \downarrow .

Command	Output	Description	EEPROM Write Access
help \downarrow	commands	Lists all available commands	
ver \downarrow	version	Provides type of sensor, software, hardware and customer version	
info \downarrow	calibration	Unit / Factor Flow / Overflow / Sensitivity / Factor Temperature	
data \downarrow	serial ID	Sensor Serial Number	
go \downarrow		Starts series of measurements	YES
s	stop	Stops series of measurements	YES
get \downarrow		Start single measurement	YES
mod=F T \downarrow	mode	Selects Flow- (F) or Temperature mode (T), (mod? = Status)	YES
res=0..7 \downarrow	resolution	Sets resolution: 0 -> 8 bits; 7 -> 15 bits, see Table 7, (res? = Status)	YES
int=x \downarrow		Interval between automatic internal temperature measurements for an internal update of the temperature compensation. 0=never, $\{1..2*10^9\}$. INT is measured in units of 5 ms. INT = 12000 therefore is an update every 60 sec. The duration of an update is 45 ms. Attention: Flow is not measured during this internal temperature update! (INT? = Status).	YES
updatetemp \downarrow		Manual command for an internal temperature measurement for internal update of the temperature compensation. Used with int=0	YES
rdatax \downarrow		reads 4 user defined bytes at the address $x=\{0,...,9\}$	
wdatax=yyyy \downarrow		writes a maximum of 4 user defined bytes at the address $x=\{0,...,9\}$	YES
test \downarrow		Sensor Selftest	YES
reset \downarrow		Resets CMOSens [®] EM1 device	

Important Notes:

- The commands are not case sensitive.
- In order to send a new command to the EM1 Mass Flow Meter make sure the EM1 is not in measurement mode. Issue therefore a stop command *s* first. After this, any instruction can be given to the EM1 Mass Flow Meter and a new series of measurement can be started by *go* \downarrow .
- The EEPROM on the EM1 has limited write cycles allowed on a memory cell (as true for every EEPROM). The EEPROM on the EM1 is specified for a minimum of 1 mio. write cycles on a single memory cell. Some commands rewrite EM1 registers in the EEPROM. These commands are marked in the column 'EEPROM Write Access'. Therefore excessive use of one of these commands e.g. for reconfiguration should be avoided. E.g. using the GET command every 5 seconds would reduce the guaranteed life time of the EEPROM to $10e7 / (60/5*60*24) = 60$ days.

3.2 Measurement frequency vs. resolution

There is a trade-off between resolution and measurement time. Possible settings are listed in Table 7. Choosing 12 bit results in a measurement interval of 80 ms. With the max resolution of 15 bit, a new measurement is provided every 640 ms.

Table 7: Resolution settings using the *res=value* command and corresponding response times

res=	Resolution [bit]	Internal signal integration time [ms]	Data rate [Hz]
0	8	5	200
1	9	10	100
2	10	20	50
3	11	40	25
4	12	80	12.5
5	13	160	6.25
6	14	320	3.125
7	15	640	1.56

Table 8: Error Codes

Error Code	Description	Notes
ERROR 01	Invalid command	
ERROR 02	Wrong syntax	
ERROR 03	Value out of range	
ERROR 04	Not allowed mode	
ERROR 05	No permission	
ERROR 06	No permission	
ERROR 50	Invalid EEPROM	
ERROR 99	Internal error	

3.3 Measurement Strategy

As mentioned in paragraph 3.1 (Important Notes) excessive EEPROM write cycles should be avoided. Sensirion therefore recommends to use the EM1 in PUSH-mode strategy: The EM1 is set to constant measurement mode and is pushing a new measurement once it becomes available. Check Table 7 for the update rate (data rate).

When using the EM1 in GET-mode strategy a measurement is started after the GET command only. At each GET command the same EEPROM memory cells are rewritten.

4 Specifications CMOSens[®] EM1 Mass Flow Meter

4.1 Absolute Maximum Ratings

Ambient storage temperature:	-40°C to 100°C / -40°F to 212°F
Ambient operating temperature:	0°C to 60°C / 32 °F to 140°F
Maximum operating pressure:	8.0 bar / 116 psi for steady operation, 12.0 bar / 174 psi for short time operation
Burst pressure:	40.0 bar / 580 psi

4.2 Electrical Specifications

Table 9: CMOSens[®] EM1 Characteristics.

Parameter	Conditions	Min.	Typ.	Max.	Units
Power Supply DC	DC	7	9	18	V
Operating Current	VDD = 9 V, no load		19		mA
	VDD = 9 V, 3k Ω at RS232 output		24		mA
Power Dissipation	VDD = 9 V, no load		171		mW

Table 10: CMOSens[®] EM1 RS232 Characteristics.

Parameter	Conditions	Min.	Typ.	Max.	Units
RS232 Output					
Output Voltage Swing	Transmitter output loaded with 3k Ω	\pm 5	\pm 9		V
Power-Off Output Resistance		300			Ω
Output Short Circuit Current			\pm 18		mA
RS232 Input					
Voltage Range		-15		15	V
Voltage Threshold					
Low		0.8	1.2		V
High			1.7	2.4	V
Hysteresis		0.2	0.5	1.0	V
Resistance		3	5	7	k Ω

Note: Free PC Software supporting serial RS232 communication can be downloaded from <http://www.sensirion.com>

5 Physical Dimensions and Mounting Information

5.1 Housing

The CMOSens[®] EM1 Mass Flow Meter is mounted in chemically inert polycarbonate housing. The rugged package has been designed to withstand overpressures of up to 8 bars (116 psi).

Physical dimensions and mounting information are provided in Figure 8 and Table 3.

5.2 Flow Connection

For flow connection a G3/8 thread (BSPP=British Standard Pipe Parallel, metric!) in an aluminum flange is provided on both sides of the EM1 device.

Only use connectors with a parallel external thread of correct size.

Do not use connectors with tapered external thread.

For best measurement results Sensirion advises strongly the use of straight inlet and outlet connectors.

5.3 Recommended connector types

Sensirion recommends the following connector types:

Metallic: Legris (www.legris.com)

No. 3101 0617 ; G3/8; Tube OD=6mm

No. 3101 0817 ; G3/8; Tube OD=8mm

No. 3101 1017 ; G3/8; Tube OD=10mm

No. 3101 1217 ; G3/8; Tube OD=12mm

No. 3101 1417 ; G3/8; Tube OD=14mm

Plastics: Hausmann (www.hausammann.com)

No. 38.129; G3/8; Tube ID=6mm

No. 38.130; G3/8; Tube ID=8mm

No. 38.131; G3/8; Tube ID=10mm

No. 38.132; G3/8; Tube ID=13mm

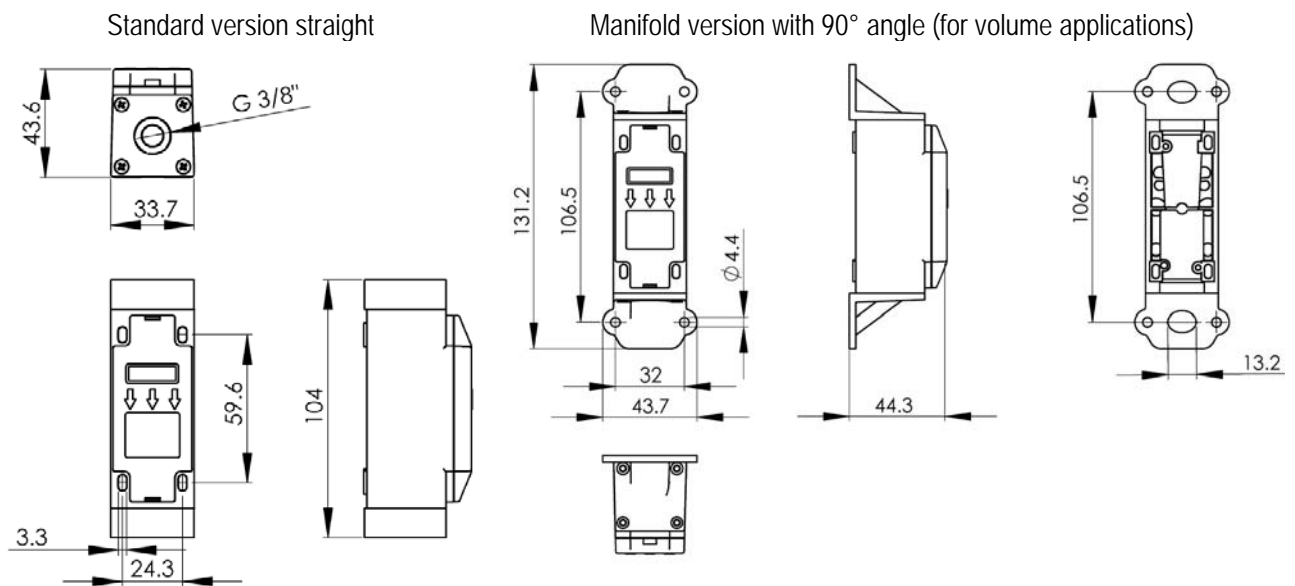

Figure 8: Physical dimensions and mounting information of the CMOSens[®] EM1. All units are in [mm]

6 Ordering Information

When ordering CMOSens® EM1 series devices please refer to the following part numbers. For the latest product information access Sensirion's website on <http://www.sensirion.com>

Table 11: Overview ordering information

Calibrated for Gas Type	Range	Connection	Code
Air	0 – 200 l/min	Straight/no connector	EM1NV4R0V_1A
Air	0 – 20 l/min	straight/no connector	EM1NR4R0V_1A
N ₂	0 – 0.5 l/min	straight/no connector	EM1NL4R0V_1N
N ₂	0 – 0.05 l/min	straight/no connector	EM1NH4R0V_1N
Other gas types on request			-

6.1 Supported Flow Units

Table 12: Units for gas flow rates

Typical flow unit	Reference condition	
	Gas Temperature	Gas Pressure
ml/min (norm milliliter per minute)	0 °C / 32° F	1013 mbar / 14.69 psi
l/min (norm liter per minute)		
sccm (standard cubic centimeter per minute)	20 °C / 68° F	
slm (standard liter per minute)		

Example: Relationship for N₂ between:

l/min (0°C, 1013 mbar)	and	slm (20°C / 68°F, 1013 mbar / 14.69)
1 l/min	=	1.073 slm
10 l/min	=	10.73 slm

7 Revision history

Table 13: Revision history

Date	Version	Page(s)	Changes
August 2002	Preliminary	all	First public release
March 2004	V2.2	all	Specifications, typos, various small modifications
March 2005	V2.3	all	Specifications, typos, various small modifications
June-August 2006	V2.5	1-5,9,10, 13-16	General update. I.e. EEPROM write access recommendation, new disclaimer, new model (Typ. EM1NH), change to aluminum flanges, introduction of revision history
October 2006	V2.6	1,16	RoHS compliance
August 2007	V2.8	all	Microprocessor EOL. Change of microprocessor. SPI Interface removed
November 2008	V2.9	12,14	order information
March 2009	V3.0	3,13,14	Flowunit corrected, Address Sensirion China

Notes:

Important Notices

Warning, personal injury

Do not use this product as safety or emergency stop devices or in any other application where failure of the product could result in personal injury. Do not use this product for applications other than its intended and authorized use. Before installing, handling, using or servicing this product, please consult the data sheet and application notes. Failure to comply with these instructions could result in death or serious injury.

If the Buyer shall purchase or use SENSIRION products for any unintended or unauthorized application, Buyer shall defend, indemnify and hold harmless SENSIRION and its officers, employees, subsidiaries, affiliates and distributors against all claims, costs, damages and expenses, and reasonable attorney fees arising out of, directly or indirectly, any claim of personal injury or death associated with such unintended or unauthorized use, even if SENSIRION shall be allegedly negligent with respect to the design or the manufacture of the product.

ESD Precautions

The inherent design of this component causes it to be sensitive to electrostatic discharge (ESD). To prevent ESD-induced damage and/or degradation, take customary and statutory ESD precautions when handling this product.

See application note "ESD, Latchup and EMC" for more information.

Warranty

SENSIRION warrants solely to the original purchaser of this product for a period of 12 months (one year) from the date of delivery that this product shall be of the quality, material and workmanship defined in SENSIRION's published specifications of the product. Within such period, if proven to be defective, SENSIRION shall repair and/or replace this product, in SENSIRION's discretion, free of charge to the Buyer, provided that:

- notice in writing describing the defects shall be given to SENSIRION within fourteen (14) days after their appearance;
- such defects shall be found, to SENSIRION's reasonable satisfaction, to have arisen from SENSIRION's faulty design, material, or workmanship;
- the defective product shall be returned to SENSIRION's factory at the Buyer's expense; and

- the warranty period for any repaired or replaced product shall be limited to the unexpired portion of the original period.

This warranty does not apply to any equipment which has not been installed and used within the specifications recommended by SENSIRION for the intended and proper use of the equipment. EXCEPT FOR THE WARRANTIES EXPRESSLY SET FORTH HEREIN, SENSIRION MAKES NO WARRANTIES, EITHER EXPRESS OR IMPLIED, WITH RESPECT TO THE PRODUCT. ANY AND ALL WARRANTIES, INCLUDING WITHOUT LIMITATION, WARRANTIES OF MERCHANTABILITY OR FITNESS FOR A PARTICULAR PURPOSE, ARE EXPRESSLY EXCLUDED AND DECLINED.

SENSIRION is only liable for defects of this product arising under the conditions of operation provided for in the data sheet and proper use of the goods. SENSIRION explicitly disclaims all warranties, express or implied, for any period during which the goods are operated or stored not in accordance with the technical specifications.

SENSIRION does not assume any liability arising out of any application or use of any product or circuit and specifically disclaims any and all liability, including without limitation consequential or incidental damages. All operating parameters, including without limitation recommended parameters, must be validated for each customer's applications by customer's technical experts. Recommended parameters can and do vary in different applications.

SENSIRION reserves the right, without further notice, (i) to change the product specifications and/or the information in this document and (ii) to improve reliability, functions and design of this product.

Copyright© 2001-2008, SENSIRION.

CMOSens® is a trademark of Sensirion

All rights reserved

FCC and CE Statement

The EM1 product has been tested and found to comply with the limits for a Class B digital device, pursuant to part 15 of the FCC Rules (FCC CFR 47). These limits are designed to provide reasonable protection against harmful interference in a residential installation. This equipment generates, uses and can radiate radio frequency energy and, if not installed and used in accordance with the instructions, may cause harmful interference to radio communications. However, there is no guarantee that interference will not occur in a particular installation. If this equipment does cause harmful interference to radio or television reception, which can be determined by turning the equipment off

and on, the user is encouraged to try to correct the interference by one or more of the following measures:

- Reorient or relocate the receiving antenna.
- Increase the separation between the equipment and the receiver
- Connect the equipment into an outlet on a circuit different from that to which the receiver is connected.
- Consult a dealer or an experienced radio/TV technician for help.



The CMOSens® EM1 device fully complies with norm EN 61000-6-1 to EN 61000-6-4 (Immunity and Emission Test Series).

RoHS and WEEE Statement

The EM1 family complies with requirements of the following directives:

- EU Directive 2002/96/EC on waste electrical and electronic equipment (WEEE), OJ13.02.2003; esp. its Article 6 (1) with Annex II.
- EU Directive 2002/95/EC on the restriction of the use of certain hazardous substances in electrical and electronic equipment (RoHS), OJ 13.02.2003; esp. its Article 4.
- The CMOSens® EM1 device fully complies with norm EN 61000-6-1 to EN 61000-6-4 (Immunity and Emission Test Series).

Headquarters and Sales Office

Sensirion AG
 Laubisruetistrasse 50
 CH-8712 Staefa ZH
 Switzerland

Phone: + 41 44 306 40 00
 Fax: + 41 44 306 40 30
 e-mail: info@sensirion.com
 Web: www.sensirion.com



Sales Office USA (for North American customers only)

SENSIRION Inc
 Westlake Pl. Ctr. I, suite 204
 2801 Townsgate Road
 Westlake Village, CA 91361
 USA

Phone: +1 805-409 4900
 Fax: +1 805-435 0467
 e-mail: michael.karst@sensirion.com
 Web: www.sensirion.com

Sales Office Korea (for Korean customers only)

Sensirion Korea Co. Ltd.
 #1414, Anyang Construction Twr B/D
 1112-1, Bisan-dong, Anyang-city
 Gyeonggi-Province,
 South Korea

Phone: +82 31-440-9925~27
 Fax: +82 31-440-9927
 e-mail: info@sensirion.co.kr
 Web: www.sensirion.co.kr

Sales Office Japan (for Japanese customers only)

Sensirion Japan Co. Ltd
 Representative Director: Keiichi Hasegawa
 Shinagawa Station Bldg. 7F, 4-23-5, Takanawa,
 Minato-ku, Tokyo, Japan

Tel : +81 3-3444-4940
 Fax: +81 3-3444-4939
 e-mail: info@sensirion.co.jp
 Web: www.sensirion.co.jp

Sales Office China (for Chinese customers only)

SENSIRION China Co. Ltd.
 Room 2411, Main Tower
 Jin Zhong Huan Business Building,
 Futian District, Shenzhen, PR China

Tel: +86 (755) 8252 1591
 Fax: +86 (411) 82520100
 e-mail: info@sensirion.com.cn
 Web: www.sensirion.com.cn