

# ecoSwitch™

## Advanced Load Management

### Controlled Load Switch with Low $R_{ON}$

## NCP45650, NCP45651

The NCP4565x series of load management devices provide a component and area-reducing solution for efficient power domain switching with inrush current limit via soft start. These devices are designed to integrate control and driver functionality with a high performance low on-resistance power MOSFET in a single package. This cost effective solution is ideal for power management and disconnect functions in USB ports requiring low power consumption in a small footprint.

### Features

- Advanced Controller with Charge Pump
- Integrated N-Channel MOSFET with Low  $R_{ON}$
- Soft-Start via Controlled Slew Rate
- Adjustable Slew Rate Control
- Power Good Output
- Thermal Shutdown
- Under Voltage Lockout
- Over Current Protection
- Input Voltage Range 1 V to 13.5 V
- Extremely Low Standby Current
- Load Bleed (NCP45650) – No Load Bleed (NCP45651)
- This is a Pb-Free Device

### Typical Applications

- Notebook and Tablet Computers
- Handheld & Mobile Electronics
- Portable Medical Devices
- Hard Drives
- Peripheral Ports

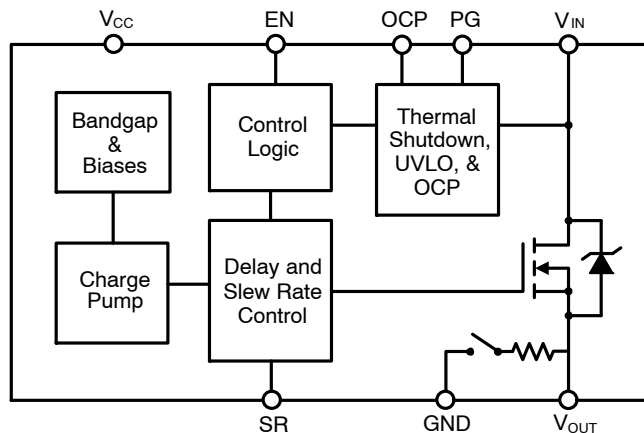

Figure 1. Block Diagram



ON Semiconductor®

[www.onsemi.com](http://www.onsemi.com)

$R_{ON}$ TYP	$V_{CC}$	$V_{IN}$	DC $I_{MAX}^*$
5.0 m $\Omega$	3.3 V	1.0 V	14 A
5.3 m $\Omega$	3.3 V	5.0 V	
6.0 m $\Omega$	3.3 V	12 V	

\* $I_{MAX}$  is defined as the maximum steady state current the load switch can pass at room ambient temperature without entering thermal lockout



DFN12, 3x3  
CASE 506DY

### MARKING DIAGRAM

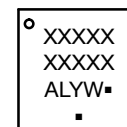

XXXXX = Specific Device Code  
A = Assembly Location  
L = Wafer Lot  
Y = Year  
W = Work Week  
▪ = Pb-Free Package

(Note: Microdot may be in either location)

### PIN CONFIGURATION

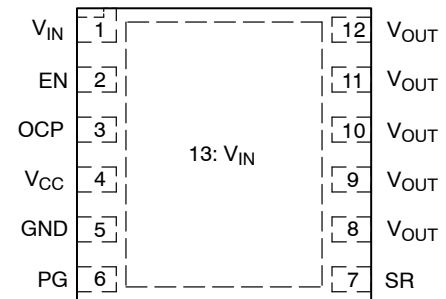

(Top View)

### ORDERING INFORMATION

Device	Package	Shipping
NCP45650IMNTWG	DFN12	3000 / Tape and Reel
NCP45651IMNTWG		

†For information on tape and reel specifications, including part orientation and tape sizes, please refer to our Tape and Reel Packaging Specification Brochure, BRD8011/D.

# NCP45650, NCP45651

**Table 1. PIN DESCRIPTION**

Pin	Name	Function
1, 13	V <sub>IN</sub>	Input voltage (1.5 V – 13.5 V)
2	EN	Active–high digital input used to turn on the MOSFET driver, pin has an internal pull down resistor to GND
3	OCP	Over–current protection trip point adjustment made with a voltage applied (0 V – 1.0 V), pin has an internal pull up resistor (250 kΩ +/-20%) to EN; float if over–current protection is not needed
4	V <sub>CC</sub>	Driver supply voltage (3.0 V – 5.5 V)
5	GND	Driver ground
6	PG	Active–high, open–drain output that indicates when the gate of the MOSFET is fully charged, external pull up resistor ≥ 100 kΩ to an external voltage source required; float if not used.
7	SR	Slew rate adjustment made with an external capacitor to GND; float if not used
8 – 12	V <sub>OUT</sub>	Source of MOSFET connected to load. Includes an internal bleed resistor to GND

**Table 2. ABSOLUTE MAXIMUM RATINGS**

Rating	Symbol	Value	Unit
Supply Voltage Range	V <sub>CC</sub>	–0.3 to 6	V
Input Voltage Range	V <sub>IN</sub>	–0.3 to 18	V
Output Voltage Range	V <sub>OUT</sub>	–0.3 to 18	V
EN Input Voltage Range	V <sub>EN</sub>	–0.3 to (V <sub>CC</sub> + 0.3)	V
PG Output Voltage Range (Note 1)	V <sub>PG</sub>	–0.3 to 6	V
OCP Input Voltage Range	V <sub>OCP</sub>	–0.3 to 6	V
Thermal Resistance, Junction–to–Ambient, Steady State (Note 2)	R <sub>θJA</sub>	44.3	°C/W
Thermal Resistance, Junction–to–Case (V <sub>IN</sub> Paddle)	R <sub>θJC</sub>	3.4	°C/W
Continuous MOSFET Current @ T <sub>A</sub> = 25°C (Note 2)	I <sub>MAX</sub>	24	A
Total Power Dissipation @ T <sub>A</sub> = 25°C (Note 2) Derate above T <sub>A</sub> = 25°C	P <sub>D</sub>	3.49 34.9	W mW/°C
Storage Temperature Range	T <sub>STG</sub>	–40 to 150	°C
Lead Temperature, Soldering (10 sec.)	T <sub>SLD</sub>	260	°C
ESD Capability, Human Body Model (Notes 3 and 4)	ESD <sub>HBM</sub>	2.0	kV
ESD Capability, Charged Device Model (Note 3)	ESD <sub>CDM</sub>	1.0	kV
Latch–up Current Immunity (Notes 3 and 4)	LU	100	mA
OFF to ON Transition Energy Dissipation Limit (See Application Section)	E <sub>TRANS</sub>	100	mJ

Stresses exceeding those listed in the Maximum Ratings table may damage the device. If any of these limits are exceeded, device functionality should not be assumed, damage may occur and reliability may be affected.

1. PG is an open–drain output that requires an external pull up resistor ≥ 1 kΩ to an external voltage source.
2. Surface–mounted on FR4 board using the minimum recommended pad size, 1 oz Cu. SC protection will engage before max current is reached.
3. Tested by the following methods @ T<sub>A</sub> = 25°C:  
 ESD Human Body Model tested per JESD22–A114  
 ESD Charged Device Model per ESD STM5.3.1  
 Latch–up Current tested per JESD78
4. Rating is for all pins except for V<sub>IN</sub> and V<sub>OUT</sub> which are tied to the internal MOSFET's Drain and Source. Typical MOSFET ESD performance for V<sub>IN</sub> and V<sub>OUT</sub> should be expected and these devices should be treated as ESD sensitive.

**Table 3. OPERATING RANGES**

Rating	Symbol	Min	Max	Unit
Supply Voltage	V <sub>CC</sub>	3	5.5	V
Input Voltage	V <sub>IN</sub>	1	13.5	V
OCP Input Voltage	V <sub>OCP</sub>	0	1	V
Ground	GND		0	V
Ambient Temperature	T <sub>A</sub>	–40	85	°C
Junction Temperature	T <sub>J</sub>	–40	125	°C

Functional operation above the stresses listed in the Recommended Operating Ranges is not implied. Extended exposure to stresses beyond the Recommended Operating Ranges limits may affect device reliability.

# NCP45650, NCP45651

**Table 4. ELECTRICAL CHARACTERISTICS** ( $T_J = 25^\circ\text{C}$ ,  $V_{CC} = 3\text{ V} - 5.5\text{ V}$ , unless otherwise specified)

Parameter	Conditions	Symbol	Min	Typ	Max	Unit
<b>MOSFET</b>						
On-Resistance	$V_{CC} = 3.3\text{ V}; V_{IN} = 1\text{ V}$	$R_{ON}$		5.0	6.5	m $\Omega$
	$V_{CC} = 3.3\text{ V}; V_{IN} = 5\text{ V}$			5.3	6.9	
	$V_{CC} = 3.3\text{ V}; V_{IN} = 12\text{ V}$			6.0	7.5	
	$V_{CC} = 3.3\text{ V}; V_{IN} = 13.5\text{ V}$			6.7	8.5	
Leakage Current (Note 5)	$V_{EN} = 0\text{ V}; V_{IN} = 13.5\text{ V}$	$I_{LEAK}$		10	100	nA

## CONTROLLER

Supply Standby Current (Note 6)	$V_{EN} = 0\text{ V}$	$I_{STBY}$		2.7	5	$\mu\text{A}$
Supply Dynamic Current (Note 7)	$V_{EN} = V_{CC} = 3\text{ V}; V_{IN} = 12\text{ V}$	$I_{DYN}$		450	750	$\mu\text{A}$
	$V_{EN} = V_{CC} = 5.5\text{ V}; V_{IN} = 1\text{ V}$			740	1000	
Internal Load Bleed Resistance (Note 8)	$V_{EN} = 0\text{ V}$	$R_{BLEED}$	300	600	1000	$\Omega$
Internal Bleed Leakage Current		$I_{BLEED}$		15	80	$\mu\text{A}$
EN Input High Voltage		$V_{IH}$	2			V
EN Input Low Voltage		$V_{IL}$			0.8	V
EN Pull Down Resistance		$R_{PD}$	80	100	120	k $\Omega$
PG Output Low Voltage	$I_{SINK} = 5\text{ mA}$	$V_{OL}$		0.12	0.2	V
PG Output Leakage Current	$V_{TERM} = 3.3\text{ V}$	$I_{OH}$		5	100	nA
Slew Rate Control Constant (Note 9)	$V_{IN} = 5\text{ V}; V_{CC} = 3\text{ V}$	$K_{SR}$	25	33	41	$\mu\text{A}$

## FAULT PROTECTIONS

Thermal Shutdown Threshold (Note 10)		$T_{SDT}$		155		$^\circ\text{C}$
Thermal Shutdown Hysteresis (Note 10)		$T_{HYS}$		20		$^\circ\text{C}$
$V_{IN}$ Under Voltage Lockout Threshold	$V_{IN}$ falling; $V_{CC} = 3\text{ V}$	$V_{UVLO}$	670	710	750	mV
$V_{IN}$ Under Voltage Lockout Threshold	$V_{IN}$ rising; $V_{CC} = 3\text{ V}$	$V_{UVLO\_RISE}$	755	795	840	mV
Over-Current Protection Trip Current (Note 12)	$V_{OCP} = 0\text{ V}$	$I_{TRIP\_OCP}$		7.5		A
Over-Current Protection Blanking Time	$V_{CC} = 3\text{ V}$	$t_{OCP}$	2	3.4	5	ms
OCP Pull Up Resistance (Note 11)		$R_{OCP}$	200	250	300	k $\Omega$
Short-Circuit Protection Trip Voltage	$V_{IN} < 4.5\text{ V}$	$V_{SC\_LVIN}$	110	150	190	mV
	$V_{IN} > 4.5\text{ V}$	$V_{SC\_HVIN}$	135	160	190	mV

Product parametric performance is indicated in the Electrical Characteristics for the listed test conditions, unless otherwise noted. Product performance may not be indicated by the Electrical Characteristics if operated under different conditions.

5. Average current from  $V_{IN}$  to  $V_{OUT}$  with MOSFET turned off.

6. Average current from  $V_{CC}$  to GND with MOSFET turned off and  $V_{in}$  is 13.5 V.

7. Average current from  $V_{CC}$  to GND after MOSFET gate is charged.

8. Resistance from  $V_{OUT}$  to GND when the MOSFET driver is disabled. The NCP45651 has no bleed and will have high impedance.

9. See Applications Information section for details on how to adjust the gate slew rate.

10. Operation above  $T_J = 125^\circ\text{C}$  is not guaranteed.

11. Internal resistor from OCP to EN used to pull up on OCP pin if not driven.

12. Min and max trip OCP trip currents are not guaranteed but typically are accurate within  $\pm 1.5\text{ A}$ .

# NCP45650, NCP45651

**Table 5. SWITCHING CHARACTERISTICS** ( $T_J = 25^\circ\text{C}$  unless otherwise specified) (Notes 13 and 14)

Parameter	Conditions	Symbol	Min	Typ	Max	Unit
Output Slew Rate – Default	$V_{CC} = 3.0\text{ V}; V_{IN} = 1.0\text{ V}$	SR		19		V/ms
	$V_{CC} = 5.0\text{ V}; V_{IN} = 1.0\text{ V}$			19		
	$V_{CC} = 3.0\text{ V}; V_{IN} = 5.0\text{ V}$		13	20	27	
	$V_{CC} = 3.0\text{ V}; V_{IN} = 13.5\text{ V}$			21		
	$V_{CC} = 5.0\text{ V}; V_{IN} = 13.5\text{ V}$			22		
Output Turn-on Delay	$V_{CC} = 3.0\text{ V}; V_{IN} = 1.0\text{ V}$	$T_{ON}$		130		$\mu\text{s}$
	$V_{CC} = 5.0\text{ V}; V_{IN} = 1.0\text{ V}$			110		
	$V_{CC} = 3.0\text{ V}; V_{IN} = 5.0\text{ V}$		50	162	230	
	$V_{CC} = 3.0\text{ V}; V_{IN} = 13.5\text{ V}$			190		
	$V_{CC} = 5.0\text{ V}; V_{IN} = 13.5\text{ V}$			185		
Output Turn-off Delay	$V_{CC} = 3.0\text{ V}; V_{IN} = 1.0\text{ V}$	$T_{OFF}$		17.5		$\mu\text{s}$
	$V_{CC} = 5.0\text{ V}; V_{IN} = 1.0\text{ V}$			5.86		
	$V_{CC} = 3.0\text{ V}; V_{IN} = 13.5\text{ V}$			14.2		
	$V_{CC} = 5.0\text{ V}; V_{IN} = 13.5\text{ V}$			2.3		
Power Good Turn-on Time	$V_{CC} = 3.0\text{ V}; V_{IN} = 1.0\text{ V}$	$T_{PG,ON}$		1.10		ms
	$V_{CC} = 5.0\text{ V}; V_{IN} = 1.0\text{ V}$			0.67		
	$V_{CC} = 3.0\text{ V}; V_{IN} = 5.0\text{ V}$		0.4	1.3	1.8	
	$V_{CC} = 3.0\text{ V}; V_{IN} = 13.5\text{ V}$			2.30		
	$V_{CC} = 5.0\text{ V}; V_{IN} = 13.5\text{ V}$			0.89		
Power Good Turn-off Time	$V_{CC} = 3.0\text{ V}; V_{IN} = 1.0\text{ V}$	$T_{PG,OFF}$		10		$\mu\text{s}$
	$V_{CC} = 5.0\text{ V}; V_{IN} = 1.0\text{ V}$			1		
	$V_{CC} = 3.0\text{ V}; V_{IN} = 13.5\text{ V}$			10		
	$V_{CC} = 5.0\text{ V}; V_{IN} = 13.5\text{ V}$			1		

13. See below figure for Test Circuit and Timing Diagram.

14. Tested with the following conditions:  $V_{TERM} = V_{CC}$ ;  $R_{PG} = 100\text{ k}\Omega$ ;  $R_L = 10\ \Omega$ ;  $C_L = 0.1\ \mu\text{F}$ .

# NCP45650, NCP45651

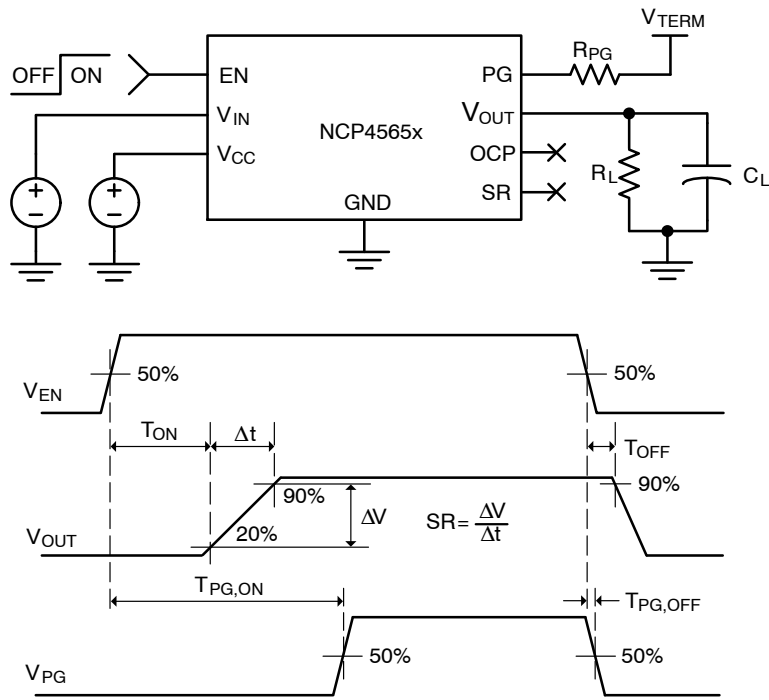
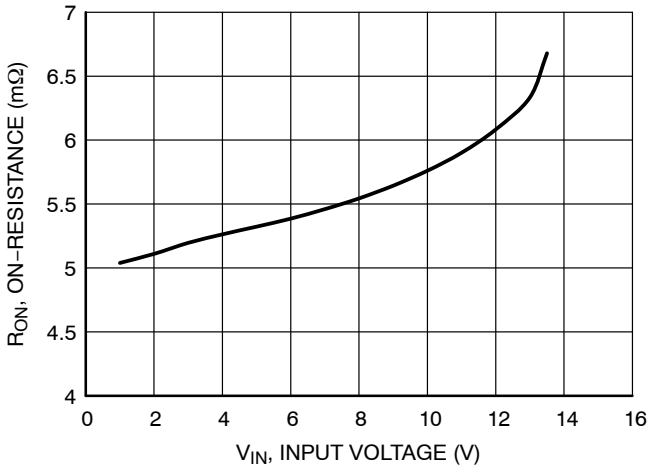

**Figure 2. Switching Characteristics Test Circuit and Timing Diagrams**

# NCP45650, NCP45651

## TYPICAL CHARACTERISTICS

( $T_J = 25^\circ\text{C}$  unless otherwise specified)



**Figure 3. On-Resistance vs. Input Voltage**

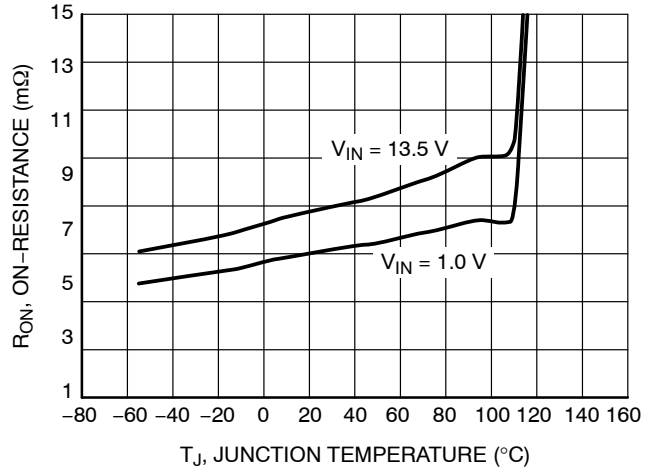

**Figure 4. On-Resistance vs. Temperature**

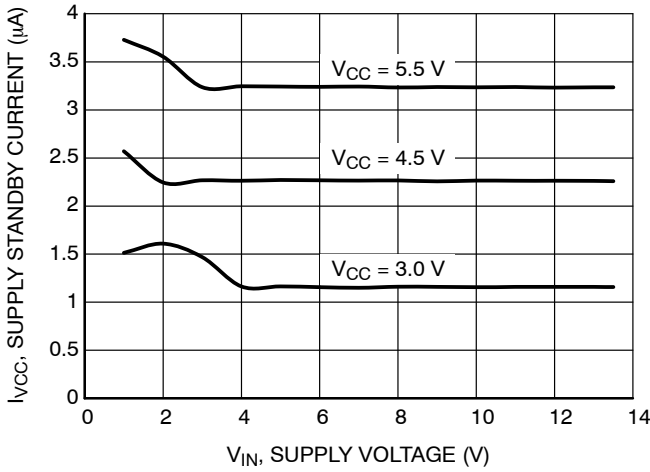

**Figure 5. Supply Standby Current vs. Supply Voltage**

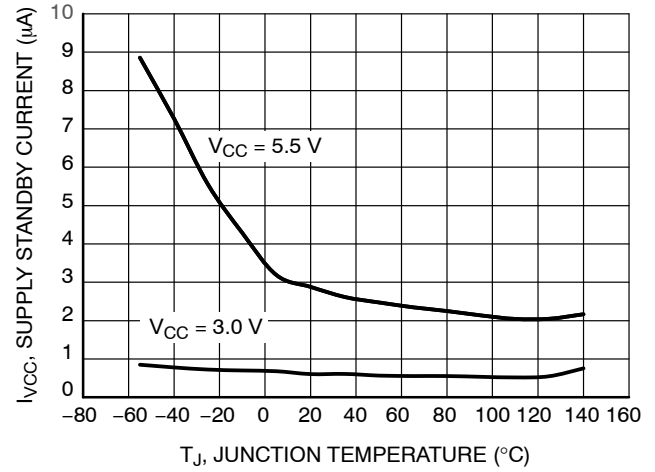

**Figure 6. Supply Standby Current vs. Temperature**

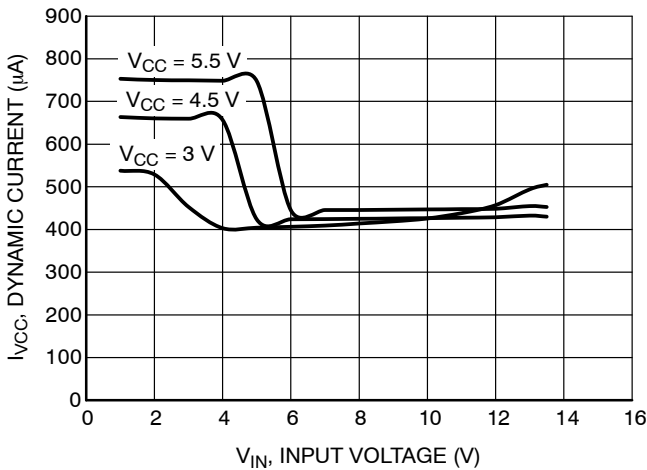

**Figure 7. Dynamic Current vs. Input Voltage**

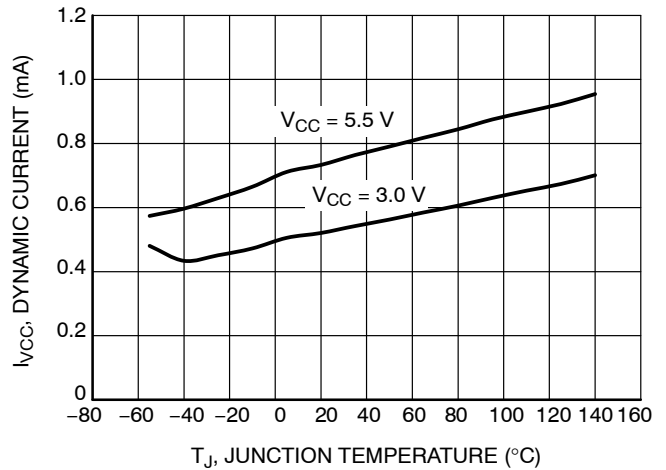

**Figure 8. Dynamic Current vs. Temperature**

# NCP45650, NCP45651

## TYPICAL CHARACTERISTICS

( $T_J = 25^\circ\text{C}$  unless otherwise specified)

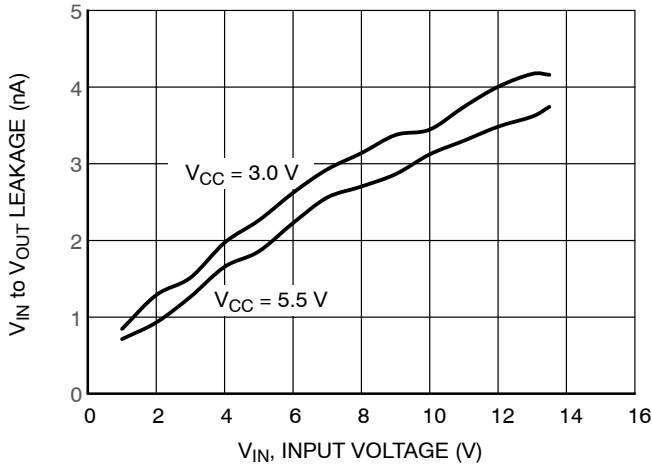

Figure 9.  $V_{IN}$  to  $V_{OUT}$  Leakage with  $EN = 0\text{ V}$

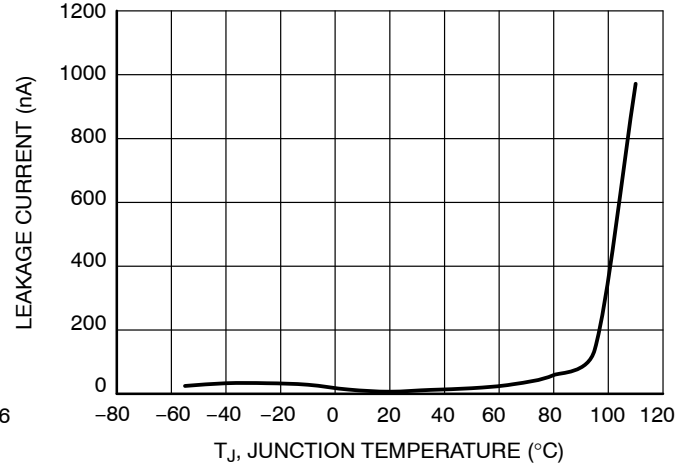

Figure 10.  $V_{IN}$  to  $V_{OUT}$  Leakage Over Temperature ( $EN = 0\text{ V}$ )

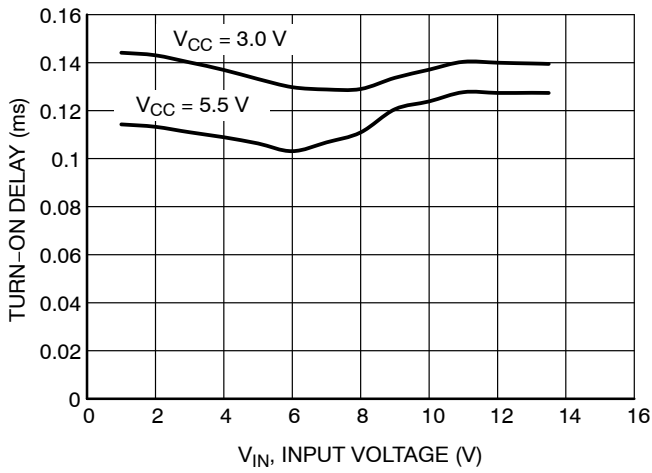

Figure 11. Output Turn-on Delay vs. Input Voltage

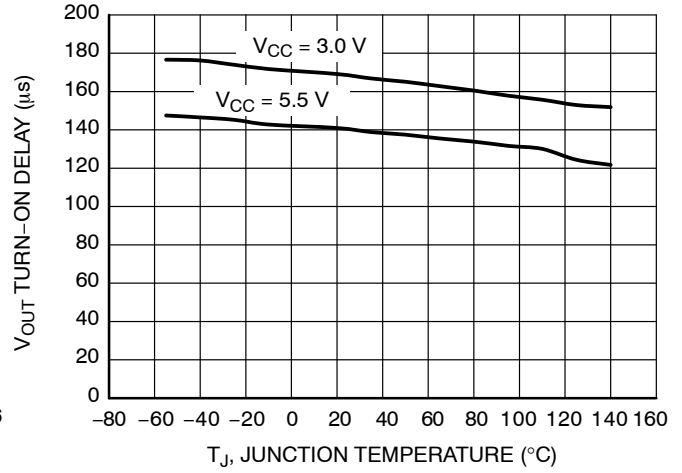
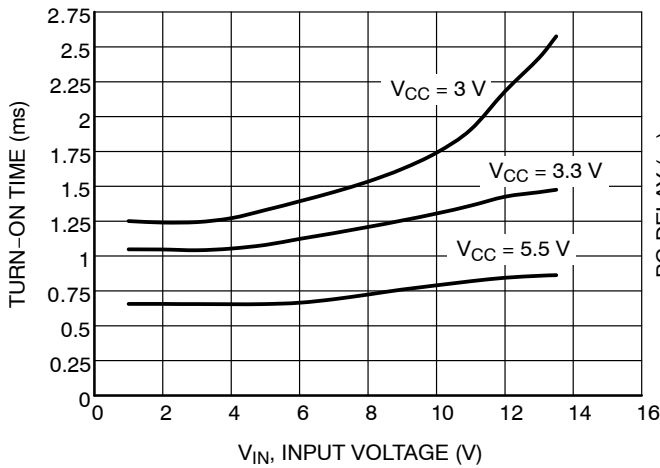

Figure 12. Output Turn-on Delay vs. Temperature ( $V_{IN} = 5.0\text{ V}$ )

# NCP45650, NCP45651

## TYPICAL CHARACTERISTICS

( $T_J = 25^\circ\text{C}$  unless otherwise specified)



**Figure 13. Power Good Turn On Turn vs. Input Voltage**

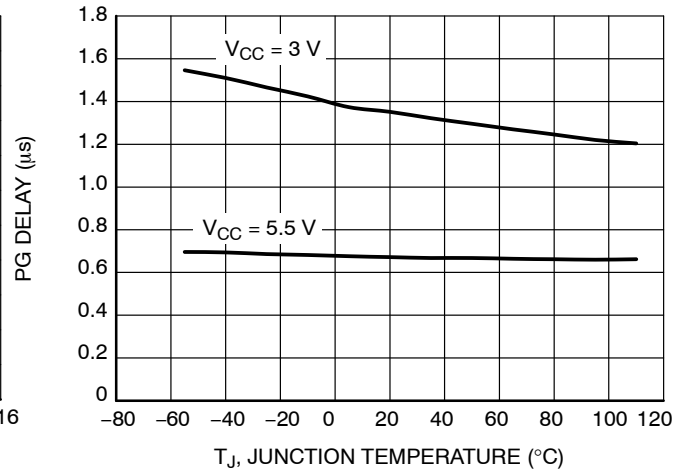

**Figure 14. Power Good Turn-on Delay vs. Temperature ( $V_{IN} = 5.0\text{V}$ )**

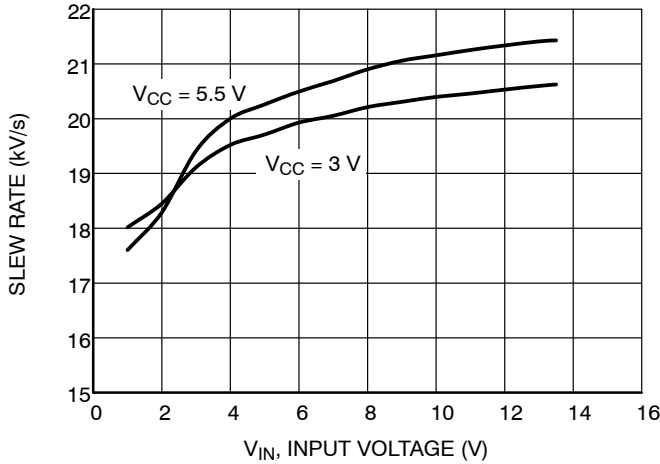

**Figure 15. Default Slew Rate vs. Input Voltage (SR pin = Floating)**

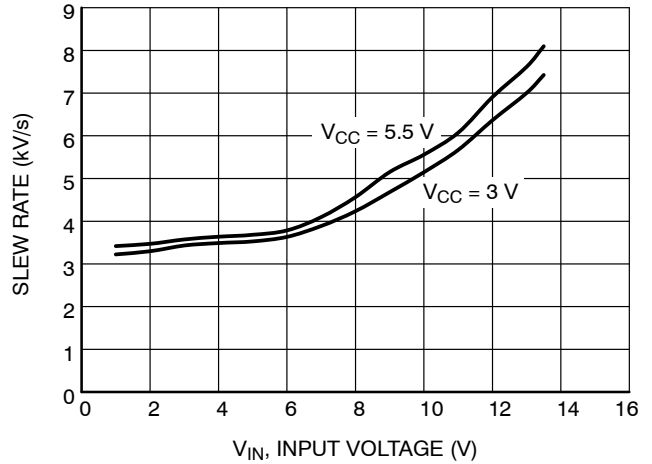

**Figure 16. Slew Rate vs. Input Voltage (SR Pin = 10 nF to GND)**

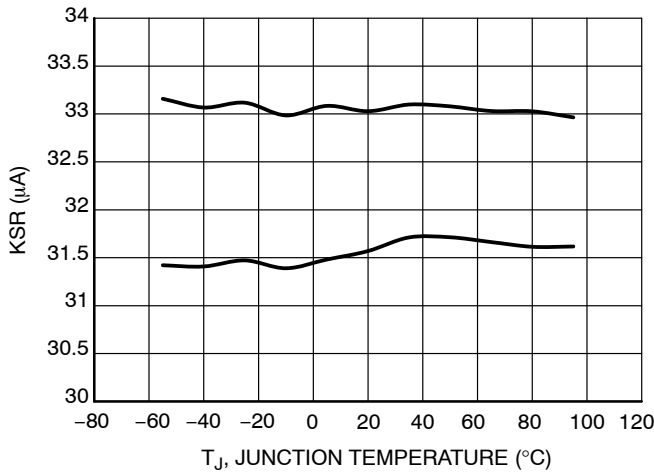

**Figure 17. KSR vs. Temperature ( $V_{IN} = 5.0\text{V}$ )**

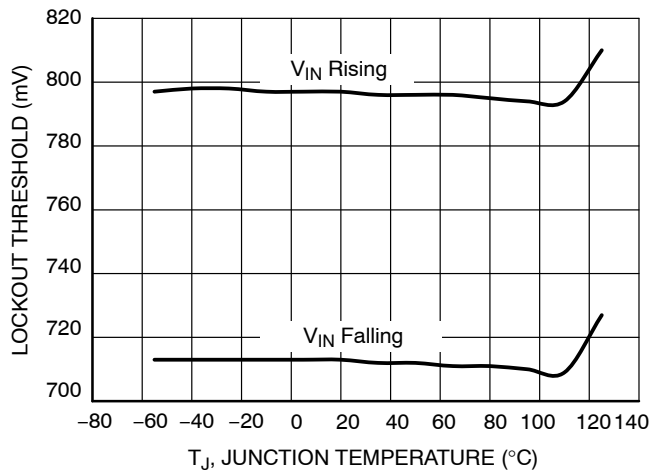

**Figure 18. UVLO Trip Voltage vs. Temperature**



## APPLICATIONS INFORMATION

### Power Sequencing

The NCP4565x will function with any power sequence, but the output turn-on delay and slew rate performance may vary from what is specified. To achieve the specified performance, there are two recommended power sequences:

1.  $V_{CC} \rightarrow V_{IN} \rightarrow V_{EN}$
2.  $V_{IN} \rightarrow V_{CC} \rightarrow V_{EN}$

$V_{CC}$  must be at 2 V or higher when EN is asserted to ensure proper operation.

### Enable Control

The NCP4565x allows for enabling the MOSFET in an active-high configuration. When the EN pin is at a logic high level and the  $V_{CC}$  supply pin has an adequate voltage applied, the MOSFET will be enabled. Similarly, when the EN pin is at a logic low level, the MOSFET will be disabled. After disabling the NCP4565x at least 400 ms must pass before EN is enabled again to ensure proper slew rate. An internal pull down resistor to ground on the EN pin ensures that the MOSFET will be disabled when not being driven.

### Load Bleed

The NCP45650 device has an on-chip bleed resistor that is used to bleed the charge off of the load to ground after the MOSFET has been disabled. In series with the bleed resistor is a bleed switch that is enabled whenever the MOSFET is disabled. Delays are added to the enable of this switch to ensure that both the MOSFET and the bleed switch are not concurrently active. The NCP45651 does not include the load bleed function.

### Over-Current and Short-Circuit Protection

The NCP4565x devices are equipped with short-circuit protection and an optional over-current protection that are used to help protect the part and the system from a sudden high-current event, such as the output,  $V_{OUT}$ , being shorted to ground. This circuitry is only active when the gate of the MOSFET is fully driven.

Once active, the circuitry monitors the difference in the voltage on the  $V_{IN}$  pin and the voltage on the  $V_{OUT}$  pin. When the difference is equal to the short-circuit protection threshold voltage, the MOSFET is immediately turned off and for the NCP45650 the load bleed is activated. The part remains latched in this off state until the  $V_{CC}$  supply voltage is cycled. When latched off the behavior of the part if EN is toggled is not defined. After the  $V_{CC}$  supply voltage is cycled and EN is high, the MOSFET will be turned on in a controlled fashion with the normal output turn-on delay and slew rate.

The over-current trip point can be enabled to allow for protection before the short-circuit threshold. If this lower threshold is not needed, then OCP can be left floating. By tying the OCP pin to ground the NCP4565x will enable the over-current protection. In the event the OCP threshold is exceeded, the MOSFET will shut down after the blanking time if the voltage difference remains greater than the

threshold. Like the short-circuit protection, the part remains latched in this off state until the  $V_{CC}$  supply voltage is cycled. When latched off the behavior of the part if EN is toggled is not defined. After the  $V_{CC}$  supply voltage is cycled and EN is high, the MOSFET will be turned on in a controlled fashion with the normal output turn-on delay and slew rate.

### Thermal Shutdown

The thermal shutdown of the NCP4565x devices protect the part from internally or externally generated excessive temperatures. This circuitry is disabled when EN is not active to reduce standby current. When an over-temperature condition is detected, the MOSFET is immediately turned off and the load bleed is activated.

The part comes out of thermal shutdown when the junction temperature decreases to a safe operating temperature as dictated by the thermal hysteresis. Upon exiting a thermal shutdown state, and if EN remains active, the MOSFET will be turned on in a controlled fashion with the normal output turn-on delay and slew rate.

### Under Voltage Lockout

The under voltage lockout of the NCP45655x devices turn the MOSFET off and activate the load bleed when the input voltage,  $V_{IN}$ , drops below the under voltage lockout threshold. This circuitry is disabled when EN is not active to reduce standby current.

If the  $V_{IN}$  voltage rises above the under voltage lockout threshold, and EN remains active, the MOSFET will be turned on in a controlled fashion with the normal output turn-on delay and slew rate.

### Power Good

The NCP4565x devices have a power good output (PG) that can be used to indicate when the gate of the MOSFET is fully charged. The PG pin is an active-high, open-drain output that requires an external pull up resistor,  $R_{PG}$ , greater than or equal to 1k to an external voltage source that is compatible with input levels of all devices connected to this pin.

The power good output can be used as the enable signal for other active-high devices in the system. This allows for guaranteed by design power sequencing and reduces the number of enable signals needed from the system controller. If the power good feature is not used in the application, the PG pin should be tied to GND.

### Slew Rate Control

The NCP4565x devices are equipped with controlled output slew rate which provides soft start functionality. This limits the inrush current caused by capacitor charging and enables these devices to be used in hot swapping applications.

The slew rate can be decreased with an external capacitor added between the SR pin and ground. With an external

capacitor present, the slew rate can be determined by the following equation:

$$\text{Slew Rate} = \frac{K_{SR}}{C_{SR}} \text{ [V/s]} \quad (\text{eq. 1})$$

Where  $K_{SR}$  is the specified slew rate control constant, found on page 3, and  $C_{SR}$  is the capacitor added between the SR pin and ground. Note that the slew rate of the device will always be the lower of the default slew rate and the adjusted slew rate. Therefore, if the  $C_{SR}$  is not large enough to decrease the slew rate more than the specified default value, the slew rate of the device will be the default value.

### Capacitive Load

The peak in-rush current associated with the initial charging of the application load capacitance needs to stay below the specified  $I_{max}$ . CL (capacitive load) should be less than  $C_{max}$  as defined by the following equation:

$$C_{max} = \frac{I_{max}}{SR_{typ}}$$

Where  $I_{max}$  is the maximum load current, and  $SR_{typ}$  is the typical default slew rate when no external load capacitor is added to the SR pin.

### OFF to ON Transition Energy Dissipation

The energy dissipation due to load current traveling from VIN to VOUT is very low during steady state operation due to the low RON. When the EN signal is asserted high, the load switch transitions from an OFF state to an ON state. During this time, the resistance from VIN to VOUT transitions from high impedance to RON, and additional energy is dissipated in the device for a short period of time. The worst case energy dissipated during the OFF to ON transition can be approximated by the following equation:

$$E = 0.5 \cdot V_{IN} \cdot (I_{INRUSH} + 0.8 \cdot I_{LOAD}) \cdot dt \quad (\text{eq. 2})$$

Where  $V_{IN}$  is the voltage on the VIN pin,  $I_{INRUSH}$  is the inrush current caused by capacitive loading on VOUT, and dt is the time it takes VOUT to rise from 0 V to VIN.  $I_{INRUSH}$  can be calculated using the following equation:

$$I_{INRUSH} = \frac{dv}{dt} \cdot C_L \quad (\text{eq. 3})$$

Where dv/dt is the programmed slew rate, and  $C_L$  is the capacitive loading on VOUT. To prevent thermal lockout or damage to the device, the energy dissipated during the OFF to ON transition should be limited to  $E_{TRANS}$  listed in Absolute Maximum Ratings.

## ecoSWITCH LAYOUT GUIDELINES

### Electrical Layout Considerations

Correct physical PCB layout is important for proper low noise accurate operation of all ecoSWITCH products.

**Power Planes:** The ecoSWITCH is optimized for extremely low Ron resistance, however, improper PCB layout can substantially increase source to load series resistance by adding PCB board parasitic resistance. Solid connections to the VIN and VOUT pins of the ecoSWITCH to copper planes should be used to achieve low series resistance and good thermal dissipation. The ecoSWITCH requires ample heat dissipation for correct thermal lockout operation. The internal FET dissipates load condition dependent amounts of power in the milliseconds following the rising edge of enable, and providing good thermal conduction from the packaging to the board is critical. Direct coupling of VIN to VOUT should be avoided, as this will adversely affect slew rates.

# MECHANICAL CASE OUTLINE

## PACKAGE DIMENSIONS

ON Semiconductor®



SCALE 2:1

DFN12 3x3, 0.5P  
CASE 506DY  
ISSUE O

DATE 22 AUG 2017

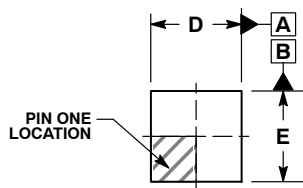

TOP VIEW

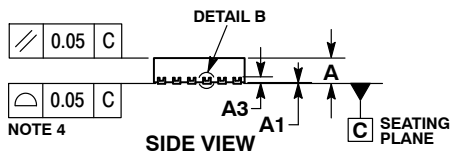

SIDE VIEW

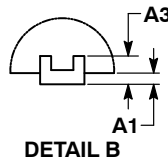

DETAIL B

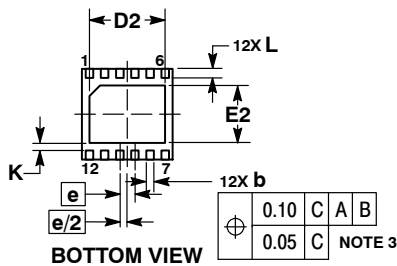

BOTTOM VIEW

### RECOMMENDED SOLDERING FOOTPRINT

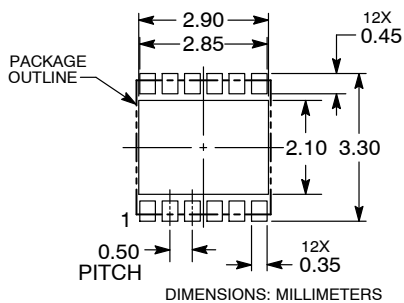

NOTES:

1. DIMENSIONING AND TOLERANCING PER ASME Y14.5M, 1994.
2. CONTROLLING DIMENSION: MILLIMETERS.
3. DIMENSION b APPLIES TO PLATED TERMINAL AND IS MEASURED BETWEEN 0.15 AND 0.30 MM FROM THE TERMINAL TIP.
4. COPLANARITY APPLIES TO THE EXPOSED PAD AS WELL AS THE TERMINALS.

MILLIMETERS			
DIM	MIN	NOM	MAX
A	0.80	0.90	1.00
A1	---	---	0.05
A3		0.20 REF	
b	0.20	0.25	0.30
D	2.90	3.00	3.10
D2	2.40	2.50	2.60
E	2.90	3.00	3.10
E2	1.80	1.90	2.00
e		0.50 BSC	
K		0.25 REF	
L	0.20	0.30	0.40

### GENERIC MARKING DIAGRAM\*

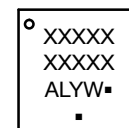

- XXXXXX = Specific Device Code
- A = Assembly Location
- L = Wafer Lot
- Y = Year
- W = Work Week
- = Pb-Free Package

(Note: Microdot may be in either location)

\*This information is generic. Please refer to device data sheet for actual part marking. Pb-Free indicator, "G" or microdot "▪", may or may not be present. Some products may not follow the Generic Marking.

\*For additional information on our Pb-Free strategy and soldering details, please download the ON Semiconductor Soldering and Mounting Techniques Reference Manual, SOLDERRM/D.

DOCUMENT NUMBER:	98AON65584G	Electronic versions are uncontrolled except when accessed directly from the Document Repository. Printed versions are uncontrolled except when stamped "CONTROLLED COPY" in red.
DESCRIPTION:	DFN12 3X3, 0.5P	PAGE 1 OF 1

ON Semiconductor and are trademarks of Semiconductor Components Industries, LLC dba ON Semiconductor or its subsidiaries in the United States and/or other countries. ON Semiconductor reserves the right to make changes without further notice to any products herein. ON Semiconductor makes no warranty, representation or guarantee regarding the suitability of its products for any particular purpose, nor does ON Semiconductor assume any liability arising out of the application or use of any product or circuit, and specifically disclaims any and all liability, including without limitation special, consequential or incidental damages. ON Semiconductor does not convey any license under its patent rights nor the rights of others.

ON Semiconductor and  are trademarks of Semiconductor Components Industries, LLC dba ON Semiconductor or its subsidiaries in the United States and/or other countries. ON Semiconductor owns the rights to a number of patents, trademarks, copyrights, trade secrets, and other intellectual property. A listing of ON Semiconductor's product/patent coverage may be accessed at [www.onsemi.com/site/pdf/Patent-Marking.pdf](http://www.onsemi.com/site/pdf/Patent-Marking.pdf). ON Semiconductor reserves the right to make changes without further notice to any products herein. ON Semiconductor makes no warranty, representation or guarantee regarding the suitability of its products for any particular purpose, nor does ON Semiconductor assume any liability arising out of the application or use of any product or circuit, and specifically disclaims any and all liability, including without limitation special, consequential or incidental damages. Buyer is responsible for its products and applications using ON Semiconductor products, including compliance with all laws, regulations and safety requirements or standards, regardless of any support or applications information provided by ON Semiconductor. "Typical" parameters which may be provided in ON Semiconductor data sheets and/or specifications can and do vary in different applications and actual performance may vary over time. All operating parameters, including "Typicals" must be validated for each customer application by customer's technical experts. ON Semiconductor does not convey any license under its patent rights nor the rights of others. ON Semiconductor products are not designed, intended, or authorized for use as a critical component in life support systems or any FDA Class 3 medical devices or medical devices with a same or similar classification in a foreign jurisdiction or any devices intended for implantation in the human body. Should Buyer purchase or use ON Semiconductor products for any such unintended or unauthorized application, Buyer shall indemnify and hold ON Semiconductor and its officers, employees, subsidiaries, affiliates, and distributors harmless against all claims, costs, damages, and expenses, and reasonable attorney fees arising out of, directly or indirectly, any claim of personal injury or death associated with such unintended or unauthorized use, even if such claim alleges that ON Semiconductor was negligent regarding the design or manufacture of the part. ON Semiconductor is an Equal Opportunity/Affirmative Action Employer. This literature is subject to all applicable copyright laws and is not for resale in any manner.

## PUBLICATION ORDERING INFORMATION

### LITERATURE FULFILLMENT:

Email Requests to: [orderlit@onsemi.com](mailto:orderlit@onsemi.com)

ON Semiconductor Website: [www.onsemi.com](http://www.onsemi.com)

### TECHNICAL SUPPORT

North American Technical Support:  
Voice Mail: 1 800-282-9855 Toll Free USA/Canada  
Phone: 011 421 33 790 2910

### Europe, Middle East and Africa Technical Support:

Phone: 00421 33 790 2910

For additional information, please contact your local Sales Representative