



Connectors > Rectangular Connectors > Rectangular Connector Hoods & Bases



Hood & Base Connector Product Type: **Hood**

Cable Entry Location: **Side**

Hood & Base Locking Device Type: **Locking**

Sealable: **Yes**

Circuit Application: **Power & Signal**

Features

Product Type Features

Product Size	8
Hood & Base Connector Product Type	Hood
Sealable	Yes

Body Features

Material	Die Cast Aluminum
Cable Entry Location	Side

Mechanical Attachment

Locking Device Location	Hood
Screw & Hole Thread Size	PG21
Hood & Base Locking Device Type	Locking

Dimensions

Width	43 mm
Length	120 mm

Usage Conditions

Corrosion Protected	Yes
---------------------	-----

Operation/Application

Circuit Application	Power & Signal
---------------------	----------------

Packaging Features

Packaging Method

Box

Product Compliance

[For compliance documentation, visit the product page on TE.com>](#)

EU RoHS Directive 2011/65/EU

Compliant

EU ELV Directive 2000/53/EC

Compliant

China RoHS 2 Directive MIIT Order No 32, 2016

No Restricted Materials Above Threshold

EU REACH Regulation (EC) No. 1907/2006

Current ECHA Candidate List: JAN 2021 (211)
 Candidate List Declared Against: JAN 2020 (205)
 SVHC > Threshold:
 Not Yet Reviewed

Halogen Content

Not Yet Reviewed for halogen content

Solder Process Capability

Not reviewed for solder process capability

Product Compliance Disclaimer

This information is provided based on reasonable inquiry of our suppliers and represents our current actual knowledge based on the information they provided. This information is subject to change. The part numbers that TE has identified as EU RoHS compliant have a maximum concentration of 0.1% by weight in homogenous materials for lead, hexavalent chromium, mercury, PBB, PBDE, DBP, BBP, DEHP, DIBP, and 0.01% for cadmium, or qualify for an exemption to these limits as defined in the Annexes of Directive 2011/65/EU (RoHS2). Finished electrical and electronic equipment products will be CE marked as required by Directive 2011/65/EU. Components may not be CE marked. Additionally, the part numbers that TE has identified as EU ELV compliant have a maximum concentration of 0.1% by weight in homogenous materials for lead, hexavalent chromium, and mercury, and 0.01% for cadmium, or qualify for an exemption to these limits as defined in the Annexes of Directive 2000/53/EC (ELV). Regarding the REACH Regulation, the information TE provides on SVHC in articles for this part number is based on the latest European Chemicals Agency (ECHA) 'Guidance on requirements for substances in articles' posted at this URL: <https://echa.europa.eu/guidance-documents/guidance-on-reach>

Compatible Parts



Also in the Series | [HDC IP65](#)



Rectangular Connector Hoods & Bases (1258)

Customers Also Bought



TE Part #1-917657-5
DYNAMIC 3200 HDR ASSY



TE Part #640250-1
3.96mm Wire-to-board housing: receptacle, with mating alignment, SL 156



TE Part #1473203-1
TH/.025 CONNECTOR SYSTEM, HOUSING



TE Part #1-480708-9
12P UMNL PLUG HSG BLK



TE Part #T0931003003-000
CODING-PIN-M3

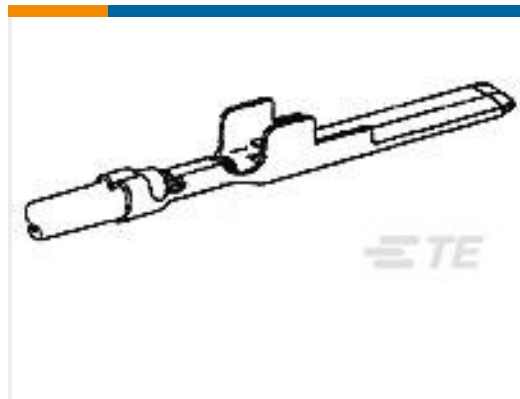

TE Part #170221-3
TAB WITH LANCE FOR M.I.C.



TE Part #1-480711-9
15P UMNL CAP HSG BLK

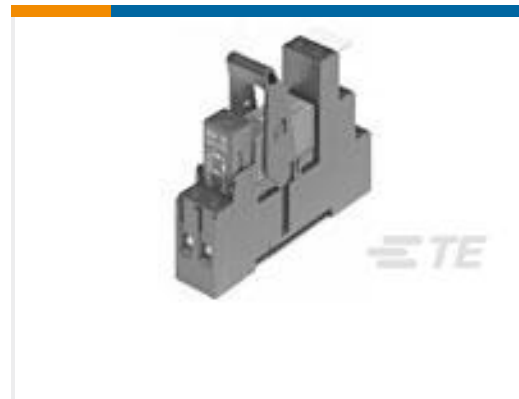

TE Part #5-1415073-1
RT3S4R24



TE Part #T1610062120-000
H6B-SGRS-M20



TE Part #T2120100219-000
ZGG-10DSTK,1-7,2-8,3-9,4-6,5-10

Documents

Product Drawings

[H24B-TS-PG21](#)

English

CAD Files

[3D PDF](#)

[3D](#)

Customer View Model

[ENG_CVM_CVM_T1210241121-000_A.2d_dxf.zip](#)



English

Customer View Model

[ENG_CVM_CVM_T1210241121-000_A.3d_igs.zip](#)

English

Customer View Model

[ENG_CVM_CVM_T1210241121-000_A.3d_stp.zip](#)

English

By downloading the CAD file I accept and agree to the [Terms and Conditions](#) of use.

Datasheets & Catalog Pages

HEAVY DUTY CONNECTORS

English

Product Specifications

Application Specification

English