

Device connector, front mounting - M17-3ES1N8AW500S/1,5 - 1069500

Please be informed that the data shown in this PDF Document is generated from our Online Catalog. Please find the complete data in the user's documentation. Our General Terms of Use for Downloads are valid (<http://phoenixcontact.com/download>)



Device connector, front mounting, straight, for standard and ONECLICK fast locking system, M17, No. of pos.: 3+PE, Crimp connection, flange dimensions: 26 mm x 26 mm, coding:N

Your advantages

- ✓ Solutions with cross-manufacturer compatibility for standard and fast locking systems
- ✓ Modern, consistent design for highly convenient operation
- ✓ Crimping connection: vibration- and temperature-resistant assembly
- ✓ All housing can be fitted with pin or socket contacts
- ✓ Safe use in the field, thanks to high degree of protection



Key Commercial Data

Packing unit	1 pc
Custom tariff number	85366990
Country of origin	Germany

Technical data

Temperature range

Ambient temperature	-40 °C ... 105 °C (see derating curve)
---------------------	--

Standards and Regulations

Safety note	WARNING: The connectors may not be plugged in or disconnected under load. Ignoring the warning or improper use may damage persons and/or property.
	• WARNING: Commission properly functioning products only. The products must be regularly inspected for damage. Decommission defective products immediately. Replace damaged products. Repairs are not possible.
	• WARNING: Only electrically qualified personnel may install and operate the product. They must observe the following safety notes. The qualified personnel must be familiar with the basics of electrical engineering. They

Device connector, front mounting - M17-3ES1N8AW500S/1,5 - 1069500

Technical data

Standards and Regulations

	must be able to recognize and prevent danger. The relevant symbol on the packaging indicates that only personnel familiar with electrical engineering are allowed to install and operate the product.
	<ul style="list-style-type: none"> • The products are suitable for applications in plant, controller, and electrical device engineering.
	<ul style="list-style-type: none"> • When operating the connectors in outdoor applications, they must be separately protected against environmental influences.
	<ul style="list-style-type: none"> • Assembled products may not be manipulated or improperly opened.
	<ul style="list-style-type: none"> • Only use mating connectors that are specified in the technical data of the standards listed (e.g. the ones listed in the product accessories online at phoenixcontact.com/products).
	<ul style="list-style-type: none"> • When using the product in direct connection with third-party manufacturers, the user is responsible.
	<ul style="list-style-type: none"> • For operating voltages > 50 V AC, conductive connector housings must be grounded
	<ul style="list-style-type: none"> • Ensure that the protective or functional ground has been properly connected.
	<ul style="list-style-type: none"> • VDE 0100/1.97 § 411.1.3.2 and DIN EN 60 204/11.98 § 14.1.3 are applicable when combining several circuits in a cable and/or connector
	<ul style="list-style-type: none"> • Only use tools recommended by Phoenix Contact
	<ul style="list-style-type: none"> • The installation notes/Design In documents online on the download page at phoenixcontact.com/products must be observed for this product.
	<ul style="list-style-type: none"> • Operate the connector only when it is fully plugged in and interlocked.
	<ul style="list-style-type: none"> • Ensure that when laying the cable, the tensile load on the connectors does not exceed the upper limit specified in the standards.
	<ul style="list-style-type: none"> • Observe the minimum bending radius of the cable. Lay the cable without twisting it.
	<ul style="list-style-type: none"> • The connector warms up in normal operation. Depending on the ambient conditions, the surface of the connector can continue to warm up. In this case, the user is responsible for posting warnings (e.g. DIN EN ISO 13732-1:2008-12).

Data of the insulating body

Coding	N
Insulator material	PA 6.6
Insertion/withdrawal cycles mechanical	100
Contact connection method	Crimp connection
Application	Power
Number of positions	4
Contact diameter of power contacts	1.5 mm
Litz wire cross section of power contacts min.	0.25 mm ²
Litz wire cross section of power contacts max.	2.5 mm ²
Rated current for power contacts	20 A

Device connector, front mounting - M17-3ES1N8AW500S/1,5 - 1069500

Technical data

Data of the insulating body

Note	for max. connection cross section
Rated voltage	630 V
Rated surge voltage	6 kV
Overvoltage category	III
Degree of pollution	3
Contact diameter of signal contacts	1.5 mm
Litz wire cross section of signal contacts min.	0.25 mm ²
Litz wire cross section of signal contacts max.	2.5 mm ²
Installation height	3000 m

Housing data

Housing material	GD-Zn
Flange dimensions	26 mm x 26 mm
Type of locking	for standard and ONECLICK fast locking system
Degree of protection (when plugged in)	IP67
	IP68, 24 h / 2 m
Thread type	M17

Environmental Product Compliance

China RoHS	Environmentally friendly use period: unlimited = EFUP-e
	No hazardous substances above threshold values

Drawings

Schematic diagram

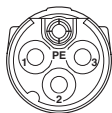

Connector pin assignment

Dimensional drawing

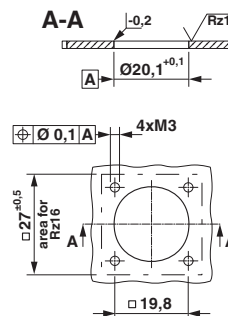

Installation dimensions

Device connector, front mounting - M17-3ES1N8AW500S/1,5 - 1069500

Diagram

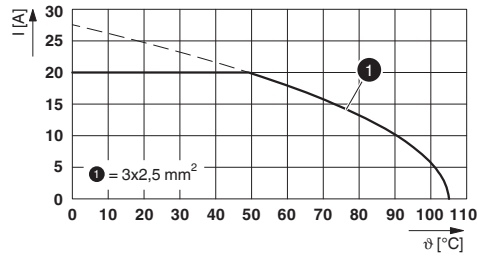

I = current strength, ϑ = ambient temperature, 3x 20 A

Dimensional drawing

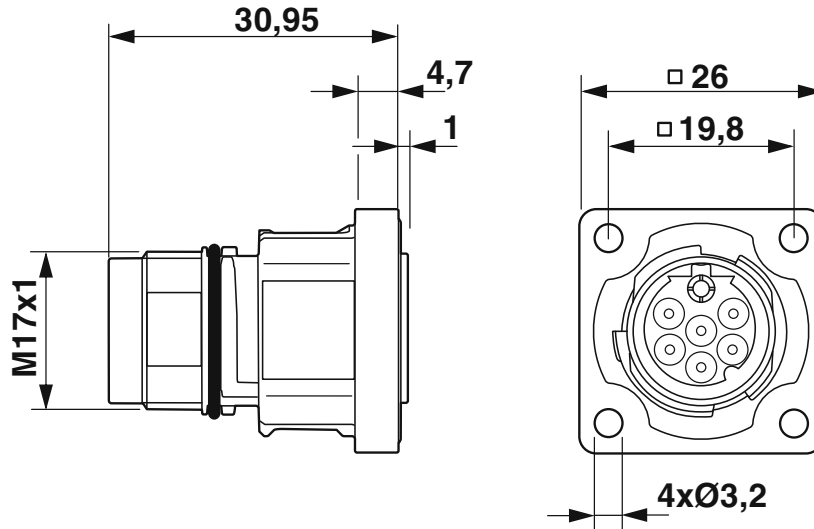

Dimensional drawing

Classifications

eCl@ss

eCl@ss 10.0.1	27440102
eCl@ss 11.0	27440102
eCl@ss 9.0	27440102

ETIM

ETIM 7.0	EC002635
----------	----------

UNSPSC

UNSPSC 18.0	39121413
-------------	----------

Device connector, front mounting - M17-3ES1N8AW500S/1,5 - 1069500

Classifications

UNSPSC

UNSPSC 19.0	39121413
UNSPSC 20.0	39121413
UNSPSC 21.0	39121413

Accessories

Accessories

Crimp contact

Crimp contact - ST-15KS0,25-2,50 - 1213854



Crimp contact

Protective cover

Metal protective cap - ST-Z0014 - 1616069



Metal protection cap for connectors with M17 external thread

Metal protective cap - ST-Z0013 - 1616068



Metal protection cap with steel wire for connectors with M17 external thread