

Data sheet | Item number: 2086-1129

THR PCB terminal block; push-button; 1.5 mm²; Pin spacing 3.5 mm; 9-pole;
Push-in CAGE CLAMP®; 1,50 mm²; black

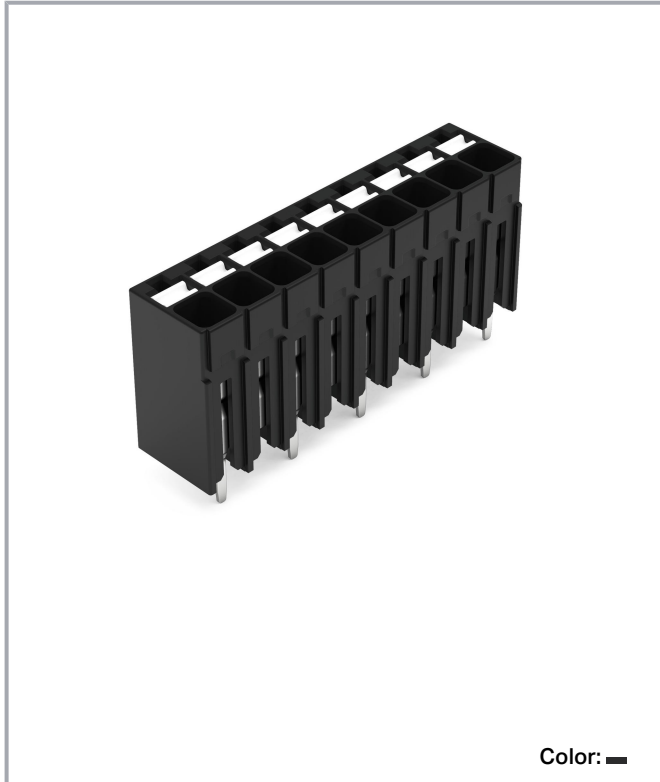

www.wago.com/2086-1129



Subject to changes. Please also observe the further product documentation!

WAGO Kontakttechnik GmbH & Co. KG
Hansastr. 27
32423 Minden
Phone: +49571 887-0 | Fax: +49571 887-169
Email: info.de@wago.com | Web: www.wago.com

Do you have any questions about our products?
We are always happy to take your call at 01788 568 008.

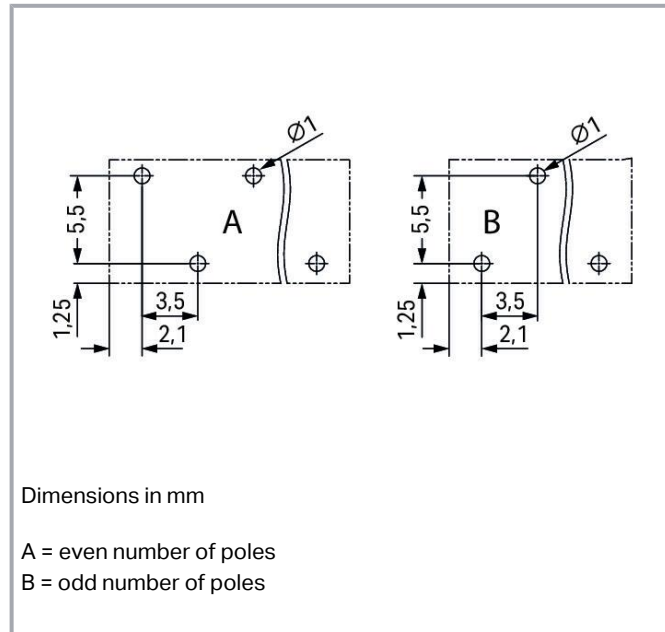
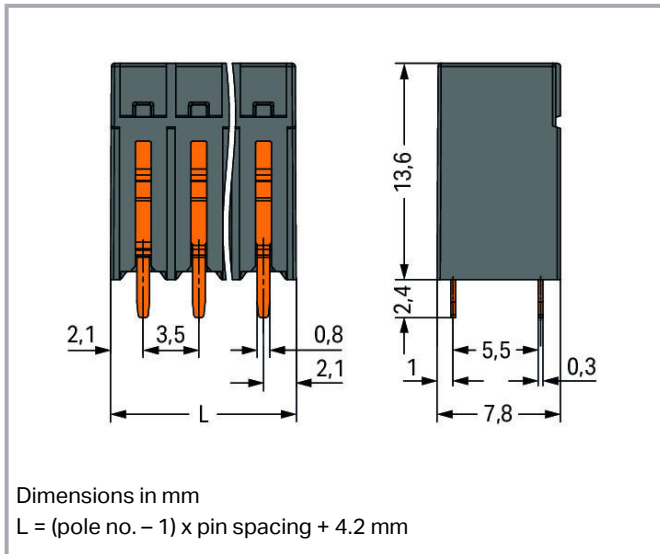

Item description

- Ideal for compact device connection, panel feedthrough and tight spaces
- Push-in CAGE CLAMP® allows push-in termination of solid and fine-stranded conductors with ferrules
- SMD and THR variants available
- Delivery in tape-and-reel packaging for full integration into SMT soldering process
- Push-button moves in direction of conductor connection
- Conductor connection and mating direction both parallel and perpendicular to the PCB
- Choice of double pin spacing or alternating pin spacing, 3.5 and 5 mm pin spacing

Data

Electrical data

Ratings per IEC/EN

| Ratings per | IEC/EN 60664-1 |
|-----------------------------|----------------|
| Nominal voltage (III/3) | 250 V |
| Rated surge voltage (III/3) | 4 kV |
| Rated voltage (III/2) | 320 V |
| Rated surge voltage (III/2) | 4 kV |
| Nominal voltage (II/2) | 630 V |
| Rated surge voltage (II/2) | 4 kV |

Subject to changes. Please also observe the further product documentation!

WAGO Kontakttechnik GmbH & Co. KG
 Hansastr. 27
 32423 Minden
 Phone: +49571 887-0 | Fax: +49571 887-169
 Email: info.de@wago.com | Web: www.wago.com

Do you have any questions about our products?
 We are always happy to take your call at 01788 568 008.

| | |
|------------------|---|
| Rated current | 17.5 A |
| Legend (ratings) | (III / 2) $\hat{=}$ Overvoltage category III / Pollution degree 2 |

Ratings per UL

| | |
|--------------------------------|---------|
| Approvals per | UL 1059 |
| Rated voltage UL (Use Group B) | 300 V |
| Rated current UL (Use Group B) | 10 A |
| Rated voltage UL (Use Group C) | 300 V |
| Rated current UL (Use Group C) | 10 A |
| Rated voltage UL (Use Group D) | 300 V |
| Rated current UL (Use Group D) | 10 A |

Ratings per CSA

| | |
|---------------------------------|-------|
| Approvals per | CSA |
| Rated voltage CSA (Use Group B) | 300 V |
| Rated current CSA (Use Group B) | 10 A |
| Rated voltage CSA (Use Group D) | 300 V |
| Rated current CSA (Use Group D) | 10 A |

Connection data

| | |
|----------------------------|---|
| Total number of potentials | 9 |
| Number of connection types | 1 |
| Number of levels | 1 |

Connection 1

| | |
|---|--|
| Connection technology | Push-in CAGE CLAMP [®] |
| Actuation type | Push-button |
| Solid conductor | 0.14 ... 1.5 mm ² / 24 ... 16 AWG |
| Fine-stranded conductor | 0.14 ... 1.5 mm ² / 24 ... 16 AWG |
| Fine-stranded conductor; with insulated ferrule | 0.25 ... 0.75 mm ² |
| Fine-stranded conductor; with uninsulated ferrule | 0.25 ... 1.5 mm ² |
| Conductor diameter | 24 ... 16 AWG |
| Strip length | 8 ... 9 mm / 0.31 ... 0.35 inch |
| Conductor connection direction to PCB | 90° |
| Pole No. | 9 |

Subject to changes. Please also observe the further product documentation!



Physical data

| | |
|------------------------------------|------------------------|
| Pin spacing | 3.5 mm / 0.138 inch |
| Width | 32.2 mm / 1.268 inch |
| Height | 16 mm / 0.63 inch |
| Height from the surface | 13.6 mm / 0.535 inch |
| Depth | 7.8 mm / 0.307 inch |
| Solder pin length | 2.4 mm |
| Solder pin dimensions | 0.3 x 0.8 mm |
| Plated through-hole diameter (THR) | 1 ^(+0.1) mm |

PCB contact

| | |
|-------------------------------------|--|
| PCB Contact | THR |
| Solder pin arrangement | over the entire terminal strip (staggered) |
| Number of solder pins per potential | 1 |

Material data

| | |
|-----------------------------|--|
| Color | black |
| Insulation material | Polyphthalamide (PPA GF) |
| Flammability class per UL94 | V0 |
| Clamping spring material | Chrome nickel spring steel (CrNi) |
| Contact material | Electrolytic copper (E _{Cu}) |
| Contact plating | tin-plated |
| Weight | 4.3 g |

Environmental requirements

| | |
|-------------------------|-----------------|
| Limit temperature range | -60 ... +105 °C |
|-------------------------|-----------------|

Commercial data

| | |
|-----------------------|---------------|
| PU (SPU) | 96 Stück |
| Packaging type | BOX |
| Country of origin | CH |
| GTIN | 4055144089356 |
| Customs tariff number | 85369010000 |



Subject to changes. Please also observe the further product documentation!

WAGO Kontakttechnik GmbH & Co. KG
 Hansastr. 27
 32423 Minden
 Phone: +49571 887-0 | Fax: +49571 887-169
 Email: info.de@wago.com | Web: www.wago.com

Do you have any questions about our products?
 We are always happy to take your call at 01788 568 008.

Approvals / Certificates



Country specific Approvals

| Logo | Approval | Additional Approval Text | Certificate name |
|--|--|--------------------------|------------------|
| | CB DEKRA Certification B.V. | IEC 60947-7-4 | NL-74022 |
|  | CSA DEKRA Certification B.V. | C22.2 | 80060692 |
|  | KEMA/KEUR DEKRA Certification B.V. | EN 60947-7-4 | 71- 119449 |

Optional accessories







Testing and measuring

Testing accessories

| | | |
|--|--|--|
|  | Item no.: 735-500 Test pin; 1 mm Ø; with solder connection for test wire | www.wago.com/735-500 |
|  | Item no.: 859-500 Test pin; 1 mm Ø; with solder connection for test wire | www.wago.com/859-500 |

Ferrule

Ferrule

| | | |
|---|--|--|
|  | Item no.: 216-101 Ferrule; Sleeve for 0.5 mm ² / AWG 22; uninsulated; electro-tin plated; silver-colored | www.wago.com/216-101 |
|  | Item no.: 216-104 Ferrule; Sleeve for 1.5 mm ² / AWG 16; uninsulated; electro-tin plated; silver-colored | www.wago.com/216-104 |
|  | Item no.: 216-102 Ferrule; Sleeve for 0.75 mm ² / AWG 20; uninsulated; electro-tin plated; silver-colored | www.wago.com/216-102 |
|  | Item no.: 216-103 Ferrule; Sleeve for 1 mm ² / AWG 18; uninsulated; electro-tin plated | www.wago.com/216-103 |
|  | Item no.: 216-142 Ferrule; Sleeve for 0.75 mm ² / 18 AWG; uninsulated; electro-tin plated; electrolytic copper; gastight crimped; acc. to DIN 46228, Part 1/08.92 | www.wago.com/216-142 |
|  | Item no.: 216-132 Ferrule; Sleeve for 0.34 mm ² / AWG 24; uninsulated; electro-tin plated | www.wago.com/216-132 |

Subject to changes. Please also observe the further product documentation!

| | | |
|----------------|---|--|
| | Item no.: 216-121 Ferrule; Sleeve for 0.5 mm ² / AWG 22; uninsulated; electro-tin plated; silver-colored | www.wago.com/216-121 |
| | Item no.: 216-143 Ferrule; Sleeve for 1 mm ² / AWG 18; uninsulated; electro-tin plated; electrolytic copper; gastight crimped; acc. to DIN 46228, Part 1/08.92 | www.wago.com/216-143 |
| | Item no.: 216-131 Ferrule; Sleeve for 0.25 mm ² / AWG 24; uninsulated; electro-tin plated; silver-colored | www.wago.com/216-131 |
| | Item no.: 216-141 Ferrule; Sleeve for 0.5 mm ² / 20 AWG; uninsulated; electro-tin plated; electrolytic copper; gastight crimped; acc. to DIN 46228, Part 1/08.92 | www.wago.com/216-141 |
| | Item no.: 216-152 Ferrule; Sleeve for 0.34 mm ² / AWG 24; uninsulated; electro-tin plated | www.wago.com/216-152 |
| | Item no.: 216-202 Ferrule; Sleeve for 0.75 mm ² / 18 AWG; insulated; electro-tin plated; gray | www.wago.com/216-202 |
| | Item no.: 216-151 Ferrule; Sleeve for 0.25 mm ² / AWG 24; uninsulated; electro-tin plated | www.wago.com/216-151 |
| | Item no.: 216-144 Ferrule; Sleeve for 1.5 mm ² / AWG 16; uninsulated; electro-tin plated; electrolytic copper; gastight crimped; acc. to DIN 46228, Part 1/08.92; silver-colored | www.wago.com/216-144 |
| | Item no.: 216-201 Ferrule; Sleeve for 0.5 mm ² / 20 AWG; insulated; electro-tin plated; white | www.wago.com/216-201 |
| | Item no.: 216-241 Ferrule; Sleeve for 0.5 mm ² / 20 AWG; insulated; electro-tin plated; electrolytic copper; gastight crimped; acc. to DIN 46228, Part 4/09.90; white | www.wago.com/216-241 |
| | Item no.: 216-242 Ferrule; Sleeve for 0.75 mm ² / 18 AWG; insulated; electro-tin plated; electrolytic copper; gastight crimped; acc. to DIN 46228, Part 4/09.90; gray | www.wago.com/216-242 |
| | Item no.: 216-301 Ferrule; Sleeve for 0.25 mm ² / AWG 24; insulated; electro-tin plated; yellow | www.wago.com/216-301 |
| | Item no.: 216-302 Ferrule; Sleeve for 0.34 mm ² / 22 AWG; insulated; electro-tin plated; green | www.wago.com/216-302 |
| Tool | | |
| Operating tool | | |
| | Item no.: 210-719 Operating tool; Blade: 2.5 x 0.4 mm; with a partially insulated shaft | www.wago.com/210-719 |

Downloads

Documentation

Additional Information

| | | | |
|------------------------|-------------|---------------|----------|
| Technical explanations | Apr 3, 2019 | pdf 2.0 MB | Download |
|------------------------|-------------|---------------|----------|

Subject to changes. Please also observe the further product documentation!

THR Soldering Process

pdf
548.2 kB

[Download](#)

CAD/CAE-Data

CAD data

2D/3D Models 2086-1129

[URL](#)

[Download](#)

CAE data

ZUKEN Portal 2086-1129

[URL](#)

[Download](#)

Environmental Product Compliance

Compliance Search

Environmental Product Compliance 2086-1129

[URL](#)

[Download](#)

THR PCB terminal block; push-button; 1.5 mm²; Pin spacing 3.5 mm; 9-pole; Push-in CAGE CLAMP®; 1,50 mm²; black

Installation Notes

Conductor termination



Inserting solid conductor via push-in termination.

Conductor removal

Subject to changes. Please also observe the further product documentation!



Removing fine-stranded conductors via push-buttons.

Conductor termination



Inserting and removing fine-stranded conductors via push-buttons.

Testing



Testing via 1 mm Ø test pin.

Touch contact with current bar.

Marking

Subject to changes. Please also observe the further product documentation!



Pole marking via direct marking
perpendicular to conductor entry.

Subject to changes. Please also observe the further product documentation!