

Data sheet | Item number: 2086-3105/700-000/997-607

SMD PCB terminal block; push-button; 1.5 mm<sup>2</sup>; Pin spacing 5 mm; 5-pole;  
Push-in CAGE CLAMP®; 1,50 mm<sup>2</sup>; black

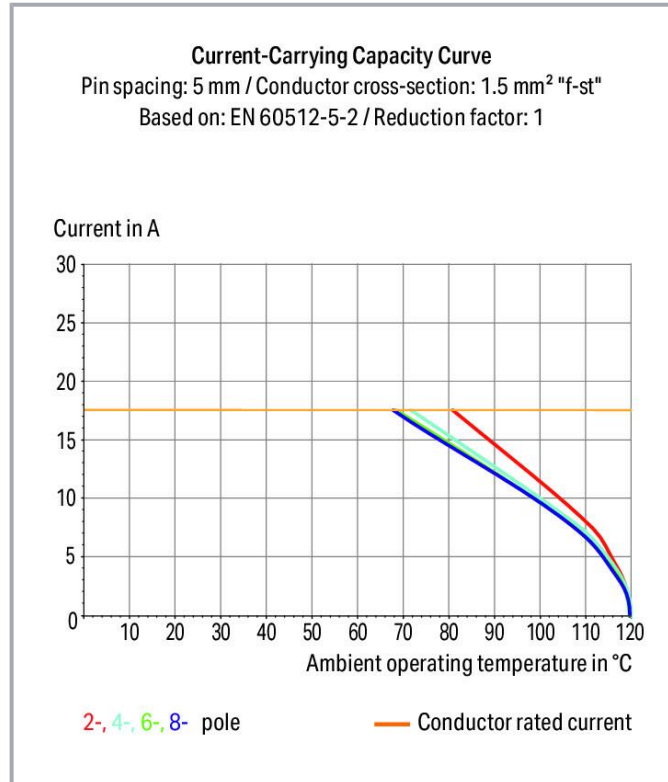

[www.wago.com/2086-3105/700-000/997-607](http://www.wago.com/2086-3105/700-000/997-607)



Subject to changes. Please also observe the further product documentation!

WAGO Kontakttechnik GmbH & Co. KG  
Hansastr. 27  
32423 Minden  
Phone: +49571 887-0 | Fax: +49571 887-169  
Email: [info.de@wago.com](mailto:info.de@wago.com) | Web: [www.wago.com](http://www.wago.com)

Do you have any questions about our products?  
We are always happy to take your call at 01788 568 008.

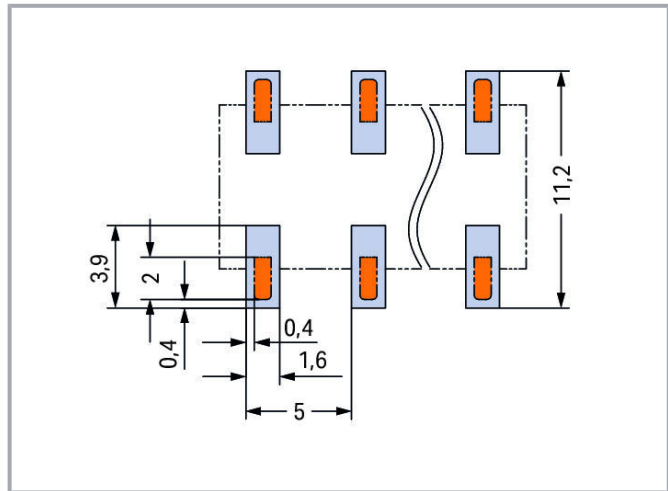
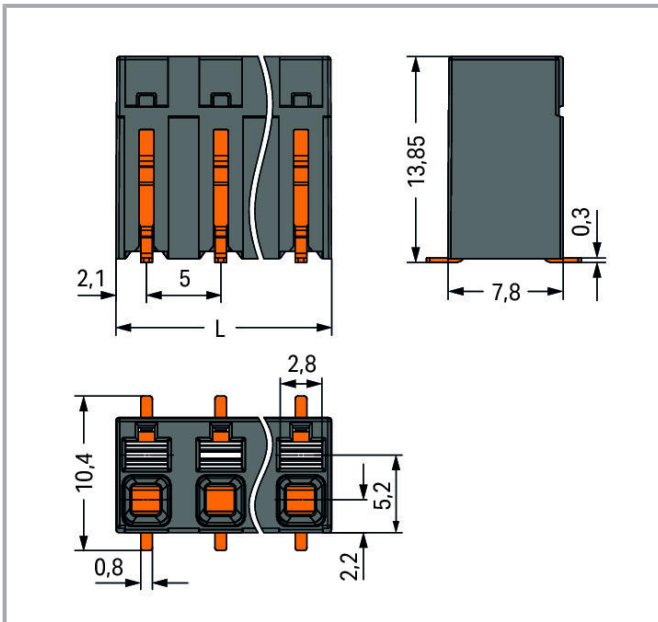

Dimensions in mm

$L = (\text{pole no.} - 1) \times \text{pin spacing} + 4.2 \text{ mm}$

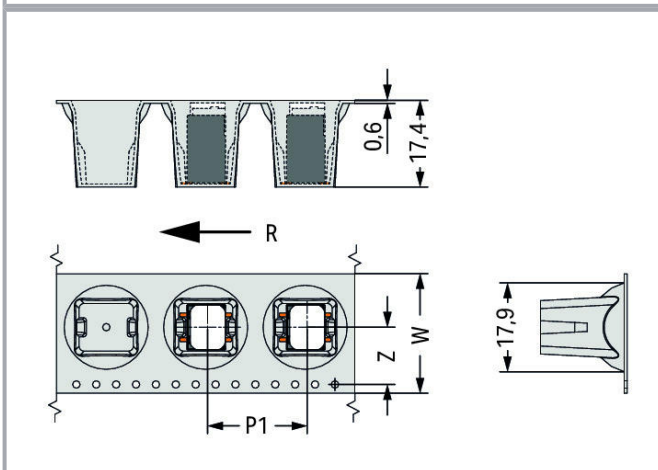

Dimensions in mm

W = Tape width

R = Feed direction

Pole No. 2: Z = 11.5 mm

Pole No. 3; 4: Z = 14.2 mm

Pole No. 5; 6; 7; 8: Z = 26.2 mm

## Item description

- Ideal for compact device connection, panel feedthrough and tight spaces
- Push-in CAGE CLAMP® allows push-in termination of solid and fine-stranded conductors with ferrules

Subject to changes. Please also observe the further product documentation!

WAGO Kontakttechnik GmbH & Co. KG

Hansastr. 27

32423 Minden

Phone: +49571 887-0 | Fax: +49571 887-169

Email: [info.de@wago.com](mailto:info.de@wago.com) | Web: [www.wago.com](http://www.wago.com)

Do you have any questions about our products?

We are always happy to take your call at 01788 568 008.



- SMD and THR variants available
- Delivery in tape-and-reel packaging for full integration into SMT soldering process
- Push-button moves in direction of conductor connection
- Conductor connection and mating direction both parallel and perpendicular to the PCB

## Data

### Electrical data

#### Ratings per IEC/EN

Ratings per	IEC/EN 60664-1
Nominal voltage (III/3)	320 V
Rated surge voltage (III/3)	4 kV
Rated voltage (III/2)	320 V
Rated surge voltage (III/2)	4 kV
Nominal voltage (II/2)	630 V
Rated surge voltage (II/2)	4 kV
Rated current	17.5 A
Legend (ratings)	(III / 2) ≙ Overvoltage category III / Pollution degree 2

#### Ratings per UL

Approvals per	UL 1059
Rated voltage UL (Use Group B)	300 V
Rated current UL (Use Group B)	10 A
Rated voltage UL (Use Group C)	300 V
Rated current UL (Use Group C)	10 A
Rated voltage UL (Use Group D)	300 V
Rated current UL (Use Group D)	10 A

#### Ratings per CSA

Approvals per	CSA
Rated voltage CSA (Use Group B)	300 V
Rated current CSA (Use Group B)	10 A
Rated voltage CSA (Use Group D)	300 V
Rated current CSA (Use Group D)	10 A

Subject to changes. Please also observe the further product documentation!

WAGO Kontakttechnik GmbH & Co. KG  
 Hansastr. 27  
 32423 Minden  
 Phone: +49571 887-0 | Fax: +49571 887-169  
 Email: [info.de@wago.com](mailto:info.de@wago.com) | Web: [www.wago.com](http://www.wago.com)

Do you have any questions about our products?  
 We are always happy to take your call at 01788 568 008.



## Connection data

Total number of potentials	5
Number of connection types	1
Number of levels	1

## Connection 1

Connection technology	Push-in CAGE CLAMP®
Actuation type	Push-button
Solid conductor	0.14 ... 1.5 mm <sup>2</sup> / 24 ... 16 AWG
Fine-stranded conductor	0.14 ... 1.5 mm <sup>2</sup> / 24 ... 16 AWG
Fine-stranded conductor; with insulated ferrule	0.25 ... 0.75 mm <sup>2</sup>
Fine-stranded conductor; with uninsulated ferrule	0.25 ... 1.5 mm <sup>2</sup>
Conductor diameter	24 ... 16 AWG
Strip length	8 ... 9 mm / 0.31 ... 0.35 inch
Conductor connection direction to PCB	90°
Pole No.	5

## Physical data

Pin spacing	5 mm / 0.197 inch
Width	24.2 mm / 0.953 inch
Height	13.85 mm / 0.545 inch
Depth	7.8 mm / 0.307 inch
Reel diameter of tape-and-reel packaging	380 mm
Tape width	56 mm

## PCB contact

PCB Contact	SMD
Solder pin arrangement	Over the entire terminal strip (in-line)
Number of solder pins per potential	2

## Material data

Color	black
Insulation material	Polyphthalamide (PPA GF)
Clamping spring material	Chrome nickel spring steel (CrNi)
Contact material	

Subject to changes. Please also observe the further product documentation!



	Electrolytic copper (E <sub>Cu</sub> )
Contact plating	Tin-plated
Fire load	0.004 MJ
Weight	5.3 g

## Environmental requirements

Limit temperature range	-60 ... +105 °C
-------------------------	-----------------

## Commercial data







PU (SPU)	1080 (270) Stück
Packaging type	box
Country of origin	CH
GTIN	4055144108309
Customs tariff number	85369010000

## Optional accessories











### Tool

Operating tool		
	<b>Item no.: 210-719</b> Operating tool; Blade: 2.5 x 0.4 mm; with a partially insulated shaft	<a href="http://www.wago.com/210-719">www.wago.com/210-719</a>

### Ferrule

Ferrule		
	<b>Item no.: 216-101</b> Ferrule; Sleeve for 0.5 mm <sup>2</sup> / AWG 22; uninsulated; electro-tin plated; silver-colored	<a href="http://www.wago.com/216-101">www.wago.com/216-101</a>
	<b>Item no.: 216-104</b> Ferrule; Sleeve for 1.5 mm <sup>2</sup> / AWG 16; uninsulated; electro-tin plated; silver-colored	<a href="http://www.wago.com/216-104">www.wago.com/216-104</a>
	<b>Item no.: 216-102</b> Ferrule; Sleeve for 0.75 mm <sup>2</sup> / AWG 20; uninsulated; electro-tin plated; silver-colored	<a href="http://www.wago.com/216-102">www.wago.com/216-102</a>
	<b>Item no.: 216-103</b> Ferrule; Sleeve for 1 mm <sup>2</sup> / AWG 18; uninsulated; electro-tin plated	<a href="http://www.wago.com/216-103">www.wago.com/216-103</a>
	<b>Item no.: 216-142</b> Ferrule; Sleeve for 0.75 mm <sup>2</sup> / 18 AWG; uninsulated; electro-tin plated; electrolytic copper; gastight crimped; acc. to DIN 46228, Part 1/08.92	<a href="http://www.wago.com/216-142">www.wago.com/216-142</a>
	<b>Item no.: 216-132</b> Ferrule; Sleeve for 0.34 mm <sup>2</sup> / AWG 24; uninsulated; electro-tin plated	<a href="http://www.wago.com/216-132">www.wago.com/216-132</a>
	<b>Item no.: 216-121</b> Ferrule; Sleeve for 0.5 mm <sup>2</sup> / AWG 22; uninsulated; electro-tin plated; silver-colored	<a href="http://www.wago.com/216-121">www.wago.com/216-121</a>

Subject to changes. Please also observe the further product documentation!

	<b>Item no.: 216-143</b> Ferrule; Sleeve for 1 mm <sup>2</sup> / AWG 18; uninsulated; electro-tin plated; electrolytic copper; gastight crimped; acc. to DIN 46228, Part 1/08.92	<a href="http://www.wago.com/216-143">www.wago.com/216-143</a>
	<b>Item no.: 216-131</b> Ferrule; Sleeve for 0.25 mm <sup>2</sup> / AWG 24; uninsulated; electro-tin plated; silver-colored	<a href="http://www.wago.com/216-131">www.wago.com/216-131</a>
	<b>Item no.: 216-141</b> Ferrule; Sleeve for 0.5 mm <sup>2</sup> / 20 AWG; uninsulated; electro-tin plated; electrolytic copper; gastight crimped; acc. to DIN 46228, Part 1/08.92	<a href="http://www.wago.com/216-141">www.wago.com/216-141</a>
	<b>Item no.: 216-152</b> Ferrule; Sleeve for 0.34 mm <sup>2</sup> / AWG 24; uninsulated; electro-tin plated	<a href="http://www.wago.com/216-152">www.wago.com/216-152</a>
	<b>Item no.: 216-202</b> Ferrule; Sleeve for 0.75 mm <sup>2</sup> / 18 AWG; insulated; electro-tin plated; gray	<a href="http://www.wago.com/216-202">www.wago.com/216-202</a>
	<b>Item no.: 216-151</b> Ferrule; Sleeve for 0.25 mm <sup>2</sup> / AWG 24; uninsulated; electro-tin plated	<a href="http://www.wago.com/216-151">www.wago.com/216-151</a>
	<b>Item no.: 216-144</b> Ferrule; Sleeve for 1.5 mm <sup>2</sup> / AWG 16; uninsulated; electro-tin plated; electrolytic copper; gastight crimped; acc. to DIN 46228, Part 1/08.92; silver-colored	<a href="http://www.wago.com/216-144">www.wago.com/216-144</a>
	<b>Item no.: 216-201</b> Ferrule; Sleeve for 0.5 mm <sup>2</sup> / 20 AWG; insulated; electro-tin plated; white	<a href="http://www.wago.com/216-201">www.wago.com/216-201</a>
	<b>Item no.: 216-241</b> Ferrule; Sleeve for 0.5 mm <sup>2</sup> / 20 AWG; insulated; electro-tin plated; electrolytic copper; gastight crimped; acc. to DIN 46228, Part 4/09.90; white	<a href="http://www.wago.com/216-241">www.wago.com/216-241</a>
	<b>Item no.: 216-242</b> Ferrule; Sleeve for 0.75 mm <sup>2</sup> / 18 AWG; insulated; electro-tin plated; electrolytic copper; gastight crimped; acc. to DIN 46228, Part 4/09.90; gray	<a href="http://www.wago.com/216-242">www.wago.com/216-242</a>
	<b>Item no.: 216-301</b> Ferrule; Sleeve for 0.25 mm <sup>2</sup> / AWG 24; insulated; electro-tin plated; yellow	<a href="http://www.wago.com/216-301">www.wago.com/216-301</a>
	<b>Item no.: 216-302</b> Ferrule; Sleeve for 0.34 mm <sup>2</sup> / 22 AWG; insulated; electro-tin plated; green	<a href="http://www.wago.com/216-302">www.wago.com/216-302</a>

## Testing and measuring

### Testing accessories

	<b>Item no.: 735-500</b> Test pin; 1 mm Ø; with solder connection for test wire	<a href="http://www.wago.com/735-500">www.wago.com/735-500</a>
	<b>Item no.: 859-500</b> Test pin; 1 mm Ø; with solder connection for test wire	<a href="http://www.wago.com/859-500">www.wago.com/859-500</a>

## Downloads

### Documentation

#### Additional Information

Technical explanations	Apr 3, 2019	pdf	Download
------------------------	-------------	-----	----------

Subject to changes. Please also observe the further product documentation!

## Environmental Product Compliance

### Compliance Search

Environmental Product Compliance 2086-3105/700-000/997-607

[URL](#)

[Download](#)

SMD PCB terminal block; push-button; 1.5 mm<sup>2</sup>; Pin spacing 5 mm; 5-pole; Push-in  
CAGE CLAMP®; 1,50 mm<sup>2</sup>; black

## Installation Notes

### Conductor termination



Inserting solid conductor via push-in termination.

### Conductor removal



Removing fine-stranded conductors via push-buttons.

### Conductor termination

Subject to changes. Please also observe the further product documentation!



Inserting and removing fine-stranded conductors via push-buttons.

### Testing

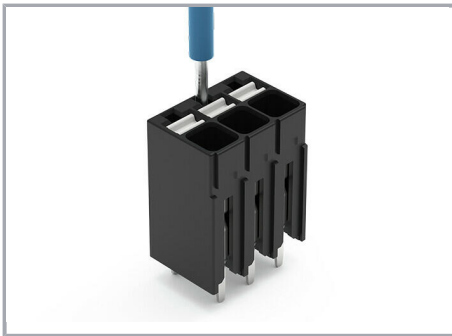

Testing via 1 mm Ø test pin.

Touch contact with current bar.

### Marking



Pole marking via direct marking perpendicular to conductor entry.

Subject to changes. Please also observe the further product documentation!