

CTlaser Mechanical accessories

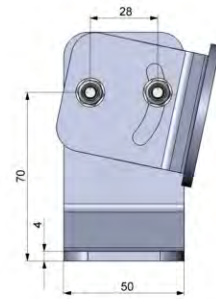
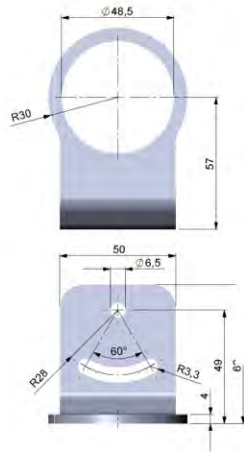

ACCTLAB

CTlaser with water cooled housing and air purge collar

Mounting bracket (fixed) for CTlaser

Mounting bracket (adjustable) for CTlaser

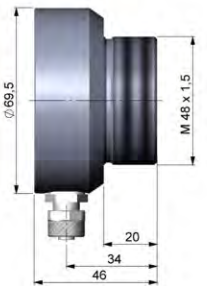
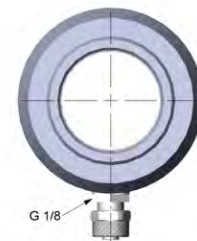
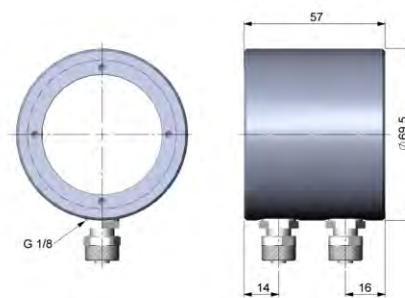

ACCTLW

Water cooled housing for CTlaser



ACCTLAP

Air purge collar for CTlaser

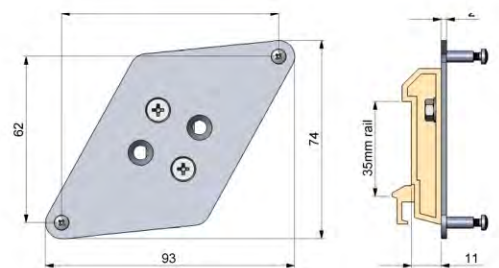
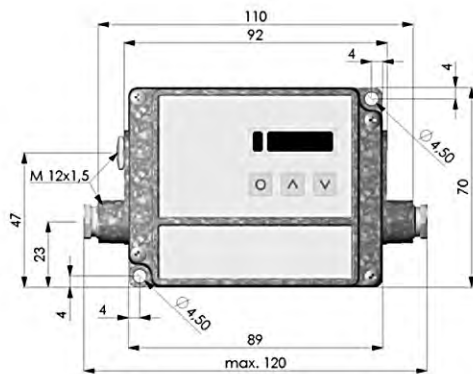

Electronics for CTlaser

DIN rail mount adaptor for CT electronics