

Technical Datasheet

[Preliminary]

Lamp LEDs are effective in hot thermal and humid condition. This high brightness and weather-resistant packaging design makes these Lamp LEDs ideal for outdoor applications such as traffic signals, variable message signs and backlighting for transparent sign panels



Features

- High luminous white emission
- Non-standoff leads
- 5mm package
- Viewing angle : 20 °
- Color Coordinates : x=0.45 y=0.41

Applications

- Electronic signs and signals
- Specialty lighting
- Small area illumination
- Torches and head lamps
- Interior lighting
- Outdoor displays



Outline Dimensions

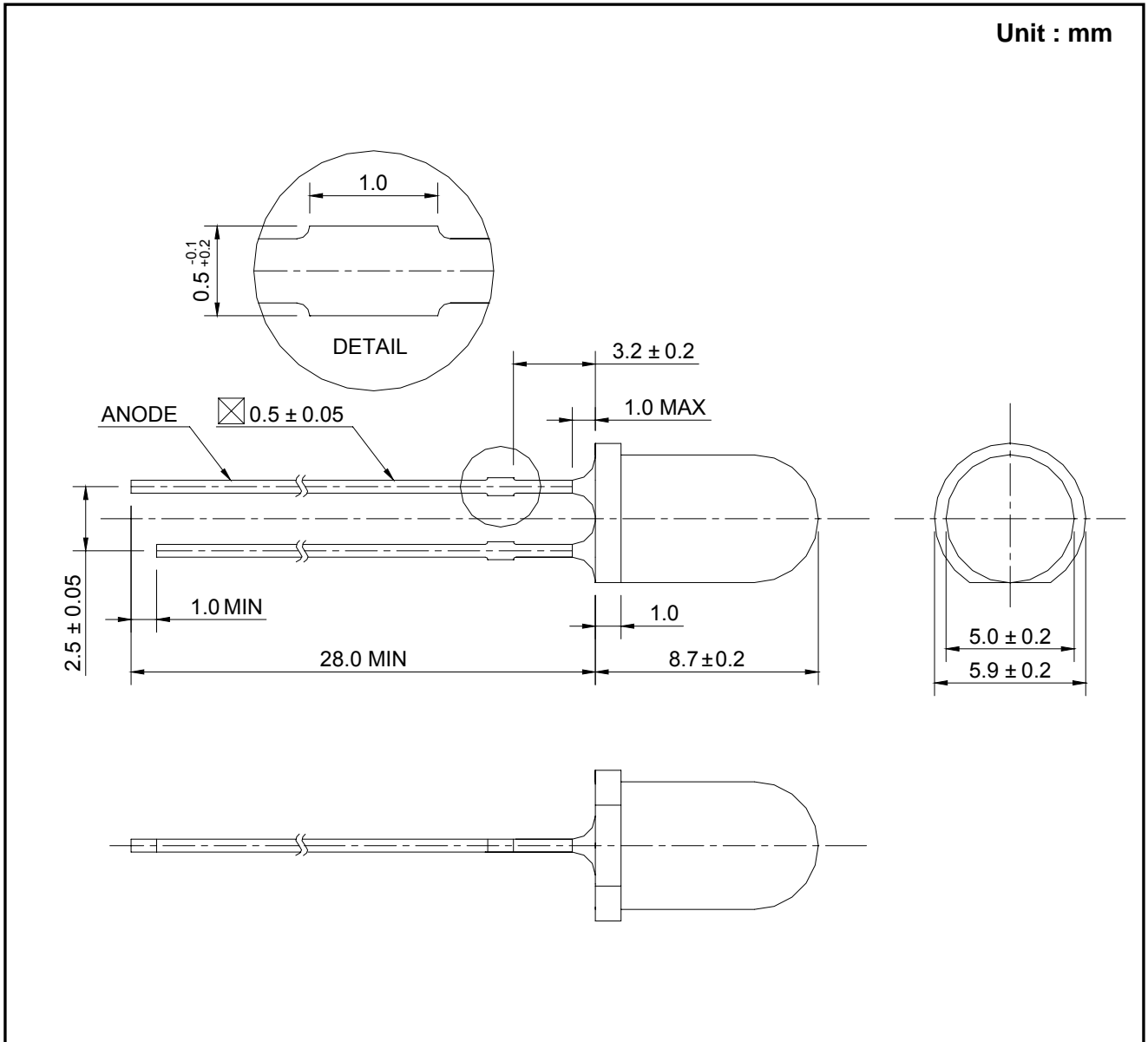

Notes : Protruded epoxy is 1.0mm maximum.

Electro-Optical Characteristics ($T_a = 25^{\circ}\text{C}$, $I_F=20\text{mA}$)

Item	Symbol	Value			Unit
		Min.	Typ.	Max.	
Luminous Intensity ^[1]	I_V ^[2]	5000	7000	-	mcd
Luminous Flux	Φ_V	-	2.7	-	lm
Chromaticity Coordinate ^[3]	x, y	x=0.45, y=0.41			-
Forward Voltage ^[4]	V_F	-	3.2	3.8	V
View Angle	$2\theta_{1/2}$	20			deg.
Thermal Resistance	$R\theta_{J-A}$	285			$^{\circ}\text{C}/\text{W}$
Optical Efficiency	η_{lc}	-	42	-	lm/W
Reverse Current (at $V_R = 5\text{V}$)	I_R	-	-	5	μA

Absolute Maximum Ratings ($T_a = 25^{\circ}\text{C}$)

Item	Symbol	Value	Unit
DC Forward Current	I_F	30	mA
Forward Peak Pulse Current	I_{FP} ^[5]	100	mA
Reverse Voltage	V_R	5	V
Power Dissipation	P_D	114	mW
Operating Temperature	T_{opr}	-30 ~ 85	$^{\circ}\text{C}$
Storage Temperature	T_{stg}	-40 ~ 100	$^{\circ}\text{C}$
Solder Temperature	T_s	260 $^{\circ}\text{C}$ for 10seconds ^[6]	$^{\circ}\text{C}$

Notes :

[1] SSC maintains a tolerance of $\pm 10\%$ on intensity and power measurements.

[2] I_V is the luminous intensity output as measured with a cylinder.

[3] Correlated Color Temperature is derived from the CIE 1931 Chromaticity diagram.

Color Coordinates Measurement allowance is ± 0.01

[4] A tolerance of $\pm 0.05\text{V}$ on forward voltage measurements

[5] $t \leq 0.1\text{ms}$, $D = 1/10$

[6] No lower than 3mm from the base of the epoxy bulb.

Reliability Tests

Item	Condition	Note	Failures
Life Test	$T_a = RT, I_F = 30mA$	1000hrs	0/22
High Temperature Operating	$T_a = 85^{\circ}C, I_F = 8mA$	1000hrs	0/22
Low Temperature Operating	$T_a = -30^{\circ}C, I_F = 20mA$	1000hrs	0/22
Thermal Shock	$T_a = -40^{\circ}C$ (30min) ~ 100° (30min) (Transfer time : 10sec, 1Cycle = 1hr)	100 cycles	0/40
Resistance to soldering Heat	$T_s = 255 \pm 5^{\circ}C, t = 10sec$	1 time	0/22
ESD (Human Body Model)	1kV, 1.5k Ω ; 100pF	1 time	0/22
High Temperature Storage	$T_a = 100^{\circ}C$	1000hrs	0/22
Low Temperature Storage	$T_a = -40^{\circ}C$	1000hrs	0/22
Temperature Humidity Storage	$T_a = 85^{\circ}C, RH = 85\%$	1000hrs	0/22
Temperature Humidity Operating	$T_a = 85^{\circ}C, RH = 85\%, I_F = 8mA$	100hrs	0/22

< Judging Criteria For Reliability Tests >

V_F	USL ^[1] X 1.2
I_R	USL X 2.0
Φ_V	LSL ^[2] X 0.5

Notes :

[1] USL : Upper Standard Level

[2] LSL : Lower Standard Level.

Characteristic Diagrams

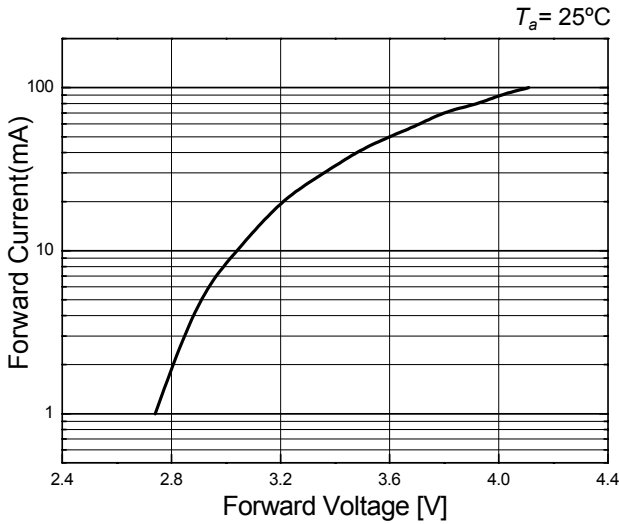

Forward Voltage vs. Forward Current

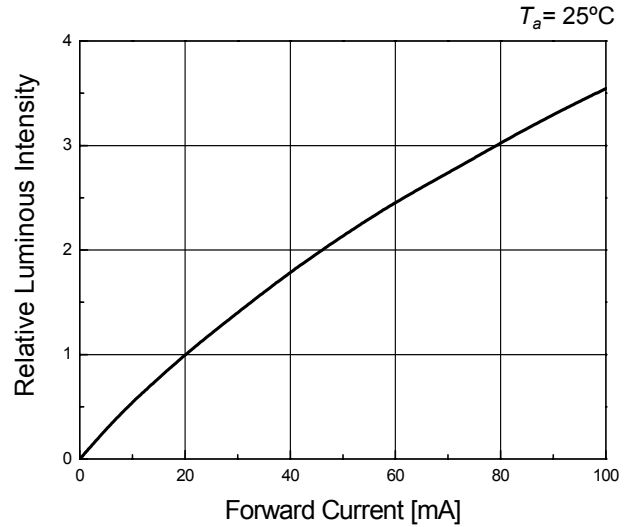

Forward Current vs. Relative Intensity

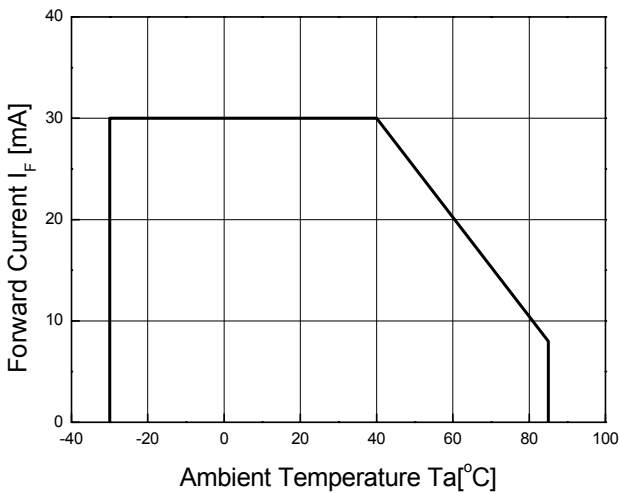

Ambient Temperature vs. Maximum Forward Current

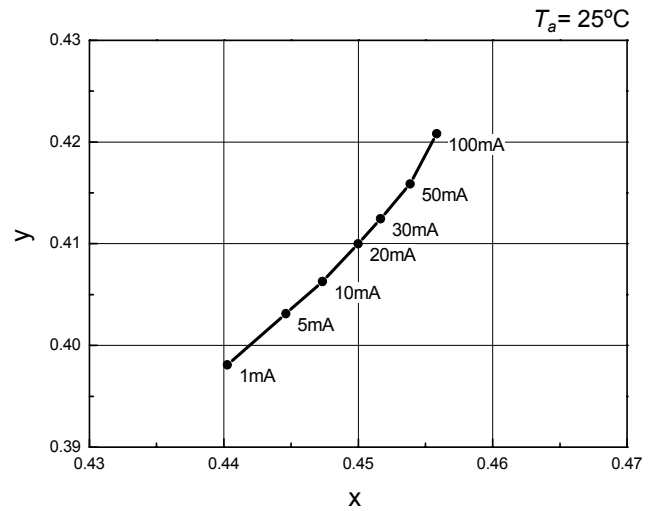

Forward Current vs. Chromaticity Coordinate

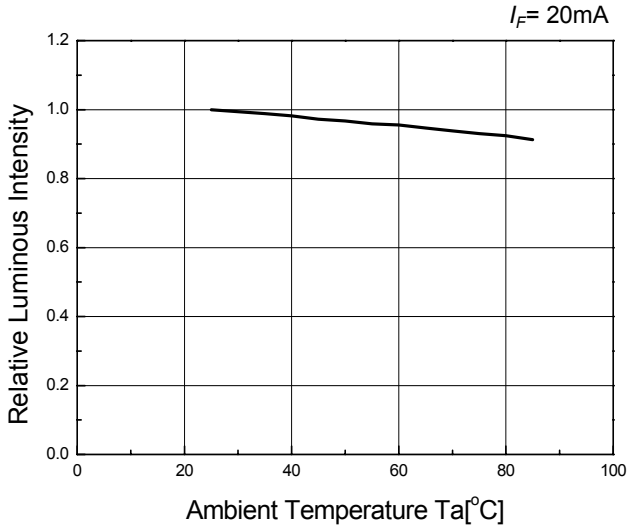

Ambient Temperature vs. Relative Intensity

Ambient Temperature vs. Forward Voltage

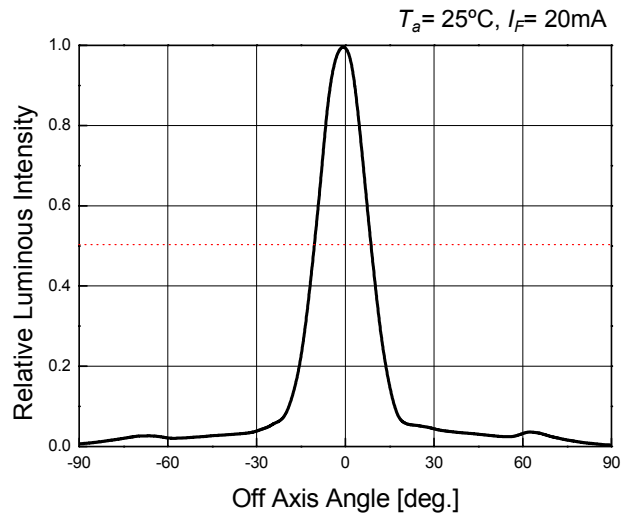
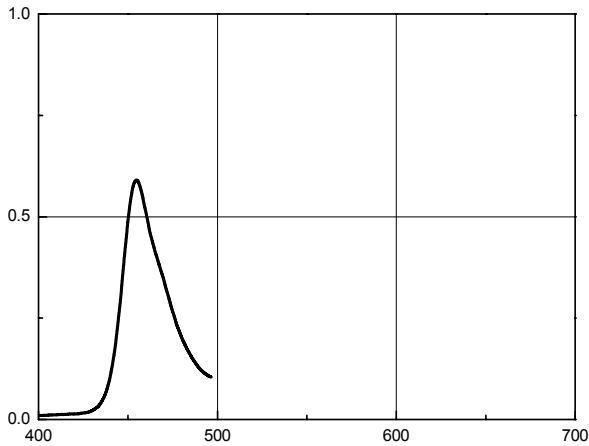

Directivity

Color Ranks

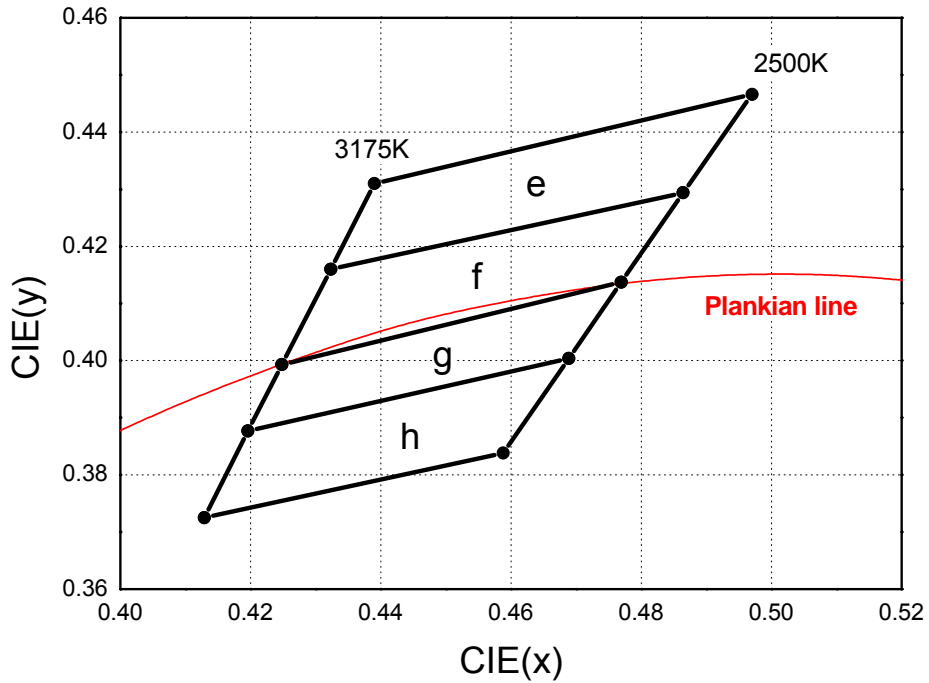

Rank e				
x	0.4390	0.4323	0.4864	0.4970
y	0.4310	0.4160	0.4294	0.4466

Rank f				
x	0.4323	0.4248	0.4769	0.4864
y	0.4160	0.3993	0.4137	0.4294

Rank g				
x	0.4248	0.4196	0.4689	0.4769
y	0.3993	0.3877	0.4004	0.4137

Rank h				
x	0.4196	0.4129	0.4588	0.4689
y	0.3877	0.3725	0.3838	0.4004

Note : Color Coordinates Measurement allowance is ± 0.01

Bin Code Description

Bin Code		
Luminous Intensity	CIE	Forward Voltage
Q	f	4

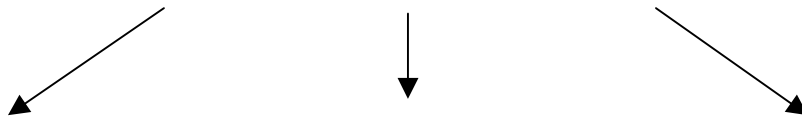

Luminous Intensity (mcd) @ $I_F = 20\text{mA}$		
Bin Code	Min.	Max.
Q	5000	7000
R	7000	10000
S	10000	14000

Color Rank @ $I_F = 20\text{mA}$
e
f
g
h

Forward Voltage (V) @ $I_F = 20\text{mA}$		
Bin Code	Min.	Max.
1	2.4	2.6
2	2.6	2.8
3	2.8	3.0
4	3.0	3.2
5	3.2	3.4
6	3.4	3.6
7	3.6	3.8

Not yet available ranks

Packing

Unit : mm

* Antistatic poly bag

LXXXX	
QTY : 500pcs	RANK
LOT : 200X.XX.XX XXX	000
 SEOUL SEMICONDUCTOR CO., LTD	

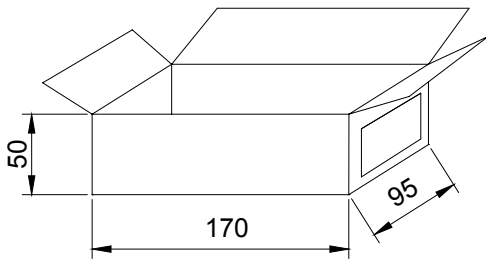

Inner box
(1bag max/box)

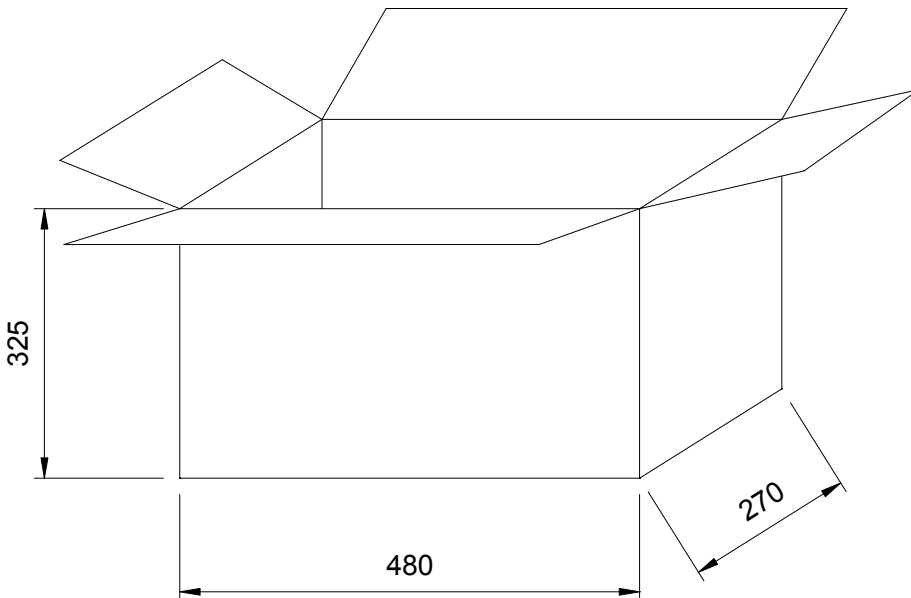

Soldering Profile

1) Wave Soldering Conditions / Profile

- Preliminary heating to be at 85°C(120 °C max) for 20 seconds(60 seconds max).
- Soldering heat to be at 255 °C (260°C max) for 10 seconds
- Soak time above 200 °C is 5 seconds

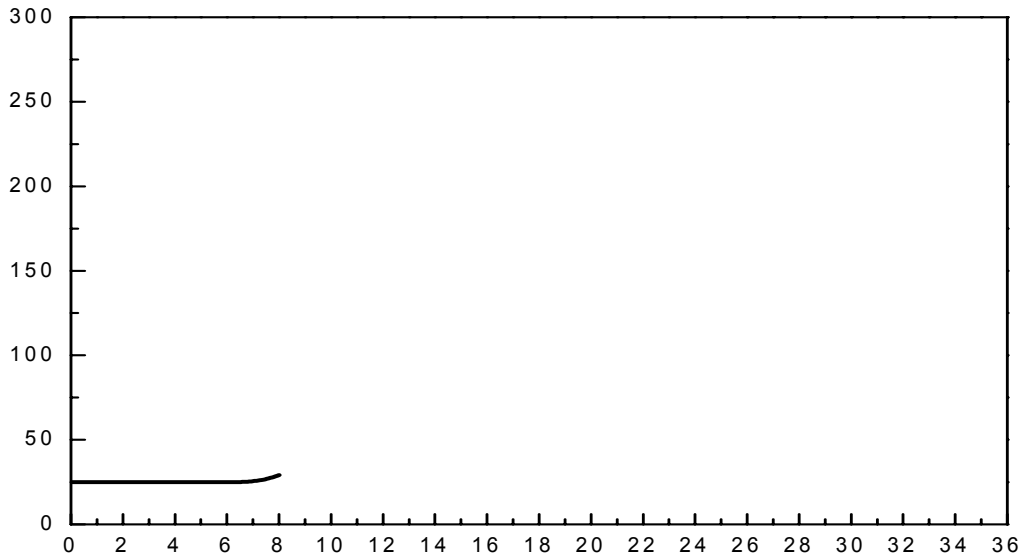

2) Hand Soldering conditions

- Not more than 3 seconds at max. 350°C, under Soldering iron.

3) Caution

- The LEDs must not be repositioned after soldering.
- Do not apply any stress to the lead particularly when heat.

Precaution for Use

1) Storage

- Before opening the package
 - a. Avoid the absorption of moisture, we recommended to store the LEDs in a dry box(or desiccator) with a desiccant . Otherwise, store them in the following environment:
Temperature : 5℃~30℃ Humidity : 50% max.
 - b. The products should be used in 3 months. It is recommended that the LEDs be used as soon as possible.
- After opening the package
 - a. Soldering should be done right after opening the package(within 24Hrs).
 - b. Keeping of a fraction
 - Sealing
 - Temperature : 5 ~ 40℃, Humidity : less than 30%
 - c. If the package has been opened more than 1week or the color of desiccant changes, Components should be dried for 10-12hr at 60±5℃
- Any mechanical force or any excess vibration shall not be accepted to apply during cooling process to normal temp. after soldering.
- Avoid quick cooling
- Leadframes are silver plated SPCC. The silver plate surface may be affected by environments which contains corrosive substances. Please avoid conditions which may cause the LEDs to corrode, tarnish or discolor.

2) Lead Forming

- When the lead forming is required before soldering , care must be taken to avoid any bending and mechanical stress. The stress to the base may damage the LEDs.
- When mounting the LEDs onto a PCB, the holes on the circuit board should be exactly aligned with the leads of the LEDs.
- It is recommended that tooling made to precisely form and cut the leads to length rather than rely on hand operating.

3) Static Electricity

- Static Electricity and surge voltage damage the LEDs. So it is recommended that a wrist band or an anti-electrostatic glove be used when handling the LEDs.
- All devices, equipment and machinery must be grounded properly. It is recommended that precautions should be taken against surge voltage to the equipment that mounts the LEDs.

4) Heat Generation

- Thermal is one of the important parameters to design the end product. Please consider the heat generation of the LEDs.
- The operating current should be decided after considering the ambient maximum temperature of LEDs.

5) Others

- The color of the LEDs is changed slightly an operating current and thermal.
- Anti radioactive ray design is not considered for the products listed here.
- Gallium arsenide is used in some of the products listed in this publication. These products are dangerous if they are burned or smashed in the process of disposal. It is also dangerous to drink the liquid or inhale the gas generated by such products when chemically disposed.
- This device should not be used in any type of fluid such as water, oil, organic solvent and etc. When washing is required, IPA(Isopropyl Alcohol) should be used.
- When the LEDs are illuminating, operating current should be decided after considering the junction temperature.
Cf.) Please refer *Ambient temperature vs. Forward Current* graph on page 5
- The appearance and specifications of the product may be modified for improvement without notice.

SEOUL SEMICONDUCTOR CO., LTD.

148-29, Kasan-Dong, Keumchun-Gu, Seoul, Korea

TEL : +82-2-3281-6269 FAX :+82-2-858-5537

Homepage : www.seoulsemicon.com www.zled.com

E-Store : www.zledstore.com

E-mail : sscsale@seoulsemicon.com