

**Dimensions: [mm]**

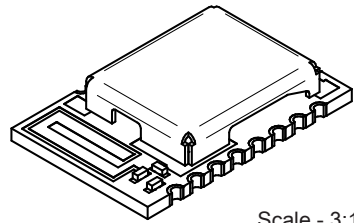

Scale - 3:1

**Recommended Land Pattern: [mm]**

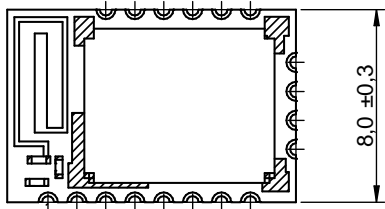
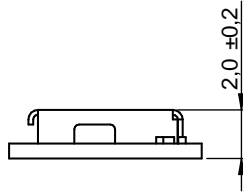
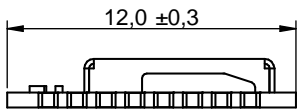
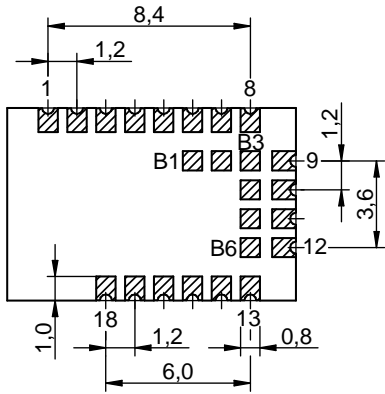
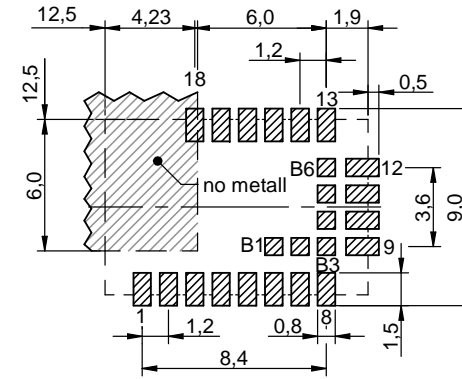

Scale - 3:1

**Product Specific Pinning:**

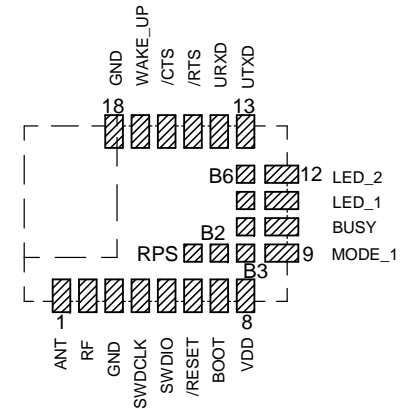

Scale - 3:1



Würth Elektronik eiSos GmbH & Co. KG  
EMC & Inductive Solutions  
Max-Eyth-Str. 1  
74638 Waldenburg  
Germany  
Tel. +49 (0) 79 42 945 - 0  
www.we-online.com  
eiSos@we-online.com

CHECKED JaC	REVISION 001.000	DATE (YYYY-MM-DD) 2021-06-22	GENERAL TOLERANCE DIN ISO 2768-1m	PROJECTION METHOD 
DESCRIPTION <b>WIRL-COMB Setebos-I Combined Proprietary 2.4GHz &amp; BTLE module T&amp;R</b>				ORDER CODE <b>2611011024020</b>
BUSINESS UNIT eiSmart			STATUS Valid	PAGE 1/7

This electronic component has been designed and developed for usage in general electronic equipment only. This product is not authorized for use in equipment where a higher safety standard and reliability standard is especially required or where a failure of the product is reasonably expected to cause severe personal injury or death, unless the parties have executed an agreement specifically governing such use. Moreover Würth Elektronik eiSos GmbH & Co KG products are neither designed nor intended for use in areas such as military, aerospace, aviation, nuclear control, submarine, transportation (automotive control, train control, ship control), transportation signal, disaster prevention, medical, public information network etc. Würth Elektronik eiSos GmbH & Co KG must be informed about the intent of such usage before the design-in stage. In addition, sufficient reliability evaluation checks for safety must be performed on every electronic component which is used in electrical circuits that require high safety and reliability functions or performance.

## General Properties:

Properties	Test conditions		Value	Unit
<b>Communication Protocol/ Standard</b>	Proprietary (P2P, star, mesh) / Bluetooth Low Energy 5.1			
<b>Antenna Connector Type</b>	ANT <sub>Conn</sub>		RF pad and internal antenna	
<b>Radio Chipset</b>	RF-IC		Nordic - nRF52840	
<b>Memory Size (Flash)</b>			1048576	B
<b>Memory Size (RAM)</b>			262144	B
<b>Channels</b>	40			
<b>Interface 1</b>	IO <sub>1</sub>	latest FW revision	UART	
<b>Interface 1 Bitrate Range</b>	IO <sub>1</sub> Bitrate	latest FW revision	115.2	kbps
<b>Number of I/O Ports</b>	IO <sub>Ports</sub>	latest FW revision	5	

## Electrical Properties:

Properties	Test conditions		Value	Unit
<b>Operating Supply Voltage Min.</b>	V <sub>DD min.</sub>	TAMB = 25 °C, RH = 60 %	1.8	V
<b>Operating Supply Voltage Max.</b>	V <sub>DD max.</sub>	TAMB = 25 °C, RH = 60 %	3.6	V
<b>Recommended Supply Voltage</b>	V <sub>DD typ</sub>	TAMB = 25 °C, RH = 60 %	3	V
<b>Supply Current Sleep</b>	I <sub>sleep</sub>	TAMB = 25 °C, RH = 60 %	0.4	µA

## Additional General Information:

<b>Operating Temperature</b>	-40 up to +85 °C
<b>Storage Conditions (in original packaging)</b>	< 40 °C ; < 90 % RH
<b>Moisture Sensitivity Level (MSL)</b>	3

## RF-Electrical Properties:

Properties	Test conditions		Value	Unit
<b>Frequency min.</b>	f <sub>min.</sub>	VDD = 3 V, TAMB = 25 °C, RH = 60 %	2402	MHz
<b>Frequency max.</b>	f <sub>max.</sub>	VDD = 3 V, TAMB = 25 °C, RH = 60 %	2480	MHz

## RF-Electrical Properties:



Properties	Test conditions		Value	Unit
<b>Line of Sight Range</b>		Two-ray ground-reflection model, antenna height = 2 m, TX and RX antenna gain = 0 dB, P <sub>TX</sub> , 50 Ω, R <sub>Xsens</sub> , 50 Ω	600	m
<b>RF Bitrate max.</b>	R <sub>b, max.</sub>	latest FW revision	2000	kbps
<b>Supply Current Transmitting</b>	I <sub>TX</sub>	VDD = 3 V, TAMB = 25 °C, RH = 60 %, PTX = 8 dBm	18.9	mA
<b>Supply Current Receiving</b>	I <sub>RX</sub>	VDD = 3 V, TAMB = 25 °C, RH = 60 %	7.7	mA
<b>Output Power 50 Ohm</b>	P <sub>TX, 50 Ω</sub>	TAMB = 25 °C, RH = 60 %, conducted	6	dBm
<b>Output Power e.r.p.</b>	P <sub>TX, e.r.p.</sub>	TAMB = 25 °C, RH = 60 %, radiated	4	dBm
<b>RX Sensitivity 50 Ohm</b>	R <sub>Xsens, 50 Ω</sub>	TAMB = 25 °C, RH = 60 %, Bitrate = 125 kbps, conducted, BER = 0.1%	-100	dBm
<b>RX sensitivity e.r.p.</b>	R <sub>Xsens, e.r.p.</sub>	TAMB = 25 °C, RH = 60 %, Bitrate = 125 kbps, radiated, BER = 0.1%	-98	dBm

## Certification:

<b>RoHS Approval</b>	Compliant [2011/65/EU&2015/863]
<b>REACH Approval</b>	Conform or declared [(EC)1907/2006]





## Product Specific Pinning:

Pin	Pad	Description	I/O
ANT	1	RF connection to PCB antenna	RF
RF	2	50 Ohm RF connection to transceiver	RF
GND	3	Ground	Supply
SWDCLK	4	Serial wire clock (SWD Interface)	SWD
SWDIO	5	Serial wire data (SWD Interface)	SWD
/RESET	6	Reset	Input
BOOT	7	Boot	Input
VDD	8	Positive supply voltage	Supply

	CHECKED	REVISION	DATE (YYYY-MM-DD)	GENERAL TOLERANCE	PROJECTION METHOD
	JaC	001.000	2021-06-22	DIN ISO 2768-1m	
	WÜRTH ELEKTRONIK eiSos GmbH & Co. KG EMC & Inductive Solutions Max-Eyth-Str. 1 74638 Waldenburg Germany Tel. +49 (0) 79 42 945 - 0 www.we-online.com eiSos@we-online.com				DESCRIPTION <b>WIRL-COMB Setebos-I Combined Proprietary 2.4GHz &amp; BTLE module T&amp;R</b>
	BUSINESS UNIT eiSmart			ORDER CODE <b>2611011024020</b>	STATUS Valid

## Product Specific Pinning:

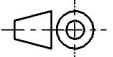
Pin	Pad	Description	I/O
MODE_1	9	Operation mode pin	Input
BUSY	10	Busy pin	Output
LED_1	11	RF transmit indication	Output
LED_2	12	RF receive indication	Output
UTXD	13	UART transmit	Output
URXD	14	UART receive	Input
/RTS	15	Request to send	Output
/CTS	16	Clear to send	Input
WAKE_UP	17	Wake-up from sleep	Input
GND	18	Negative supply voltage	Supply
RPS	B1	Radio protocol selection (Proprietary or Bluetooth Low Energy 5.1)	Input
B2	B2	Programmable GPIO	I/O
B3	B3	Programmable GPIO	I/O
B4	B4	Programmable GPIO	I/O
B5	B5	Programmable GPIO	I/O
B6	B6	Programmable GPIO	I/O

  	CHECKED JaC	REVISION 001.000	DATE (YYYY-MM-DD) 2021-06-22	GENERAL TOLERANCE DIN ISO 2768-1m	PROJECTION METHOD 	
	DESCRIPTION <b>WIRL-COMB Setebos-I Combined Proprietary 2.4GHz &amp; BTLE module T&amp;R</b>				ORDER CODE <b>2611011024020</b>	
	Würth Elektronik eiSos GmbH & Co. KG EMC & Inductive Solutions Max-Eyth-Str. 1 74638 Waldenburg Germany Tel. +49 (0) 79 42 945 - 0 www.we-online.com eiSos@we-online.com			BUSINESS UNIT eiSmart	STATUS Valid	PAGE 3/7

# Packaging Specification - Tape and Reel: [mm]

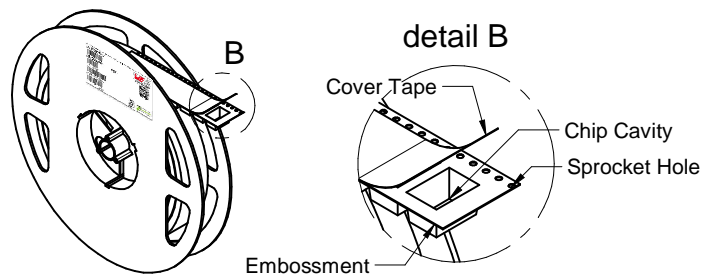
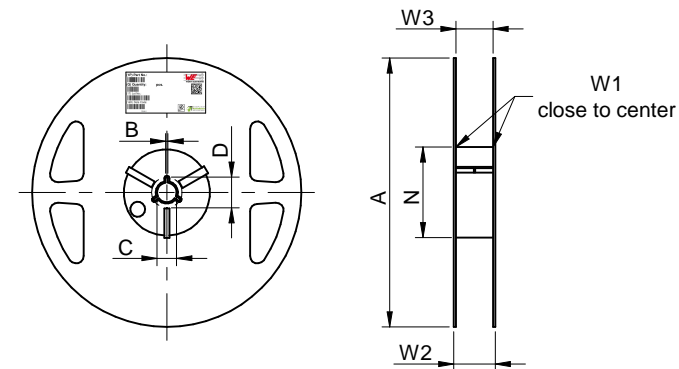
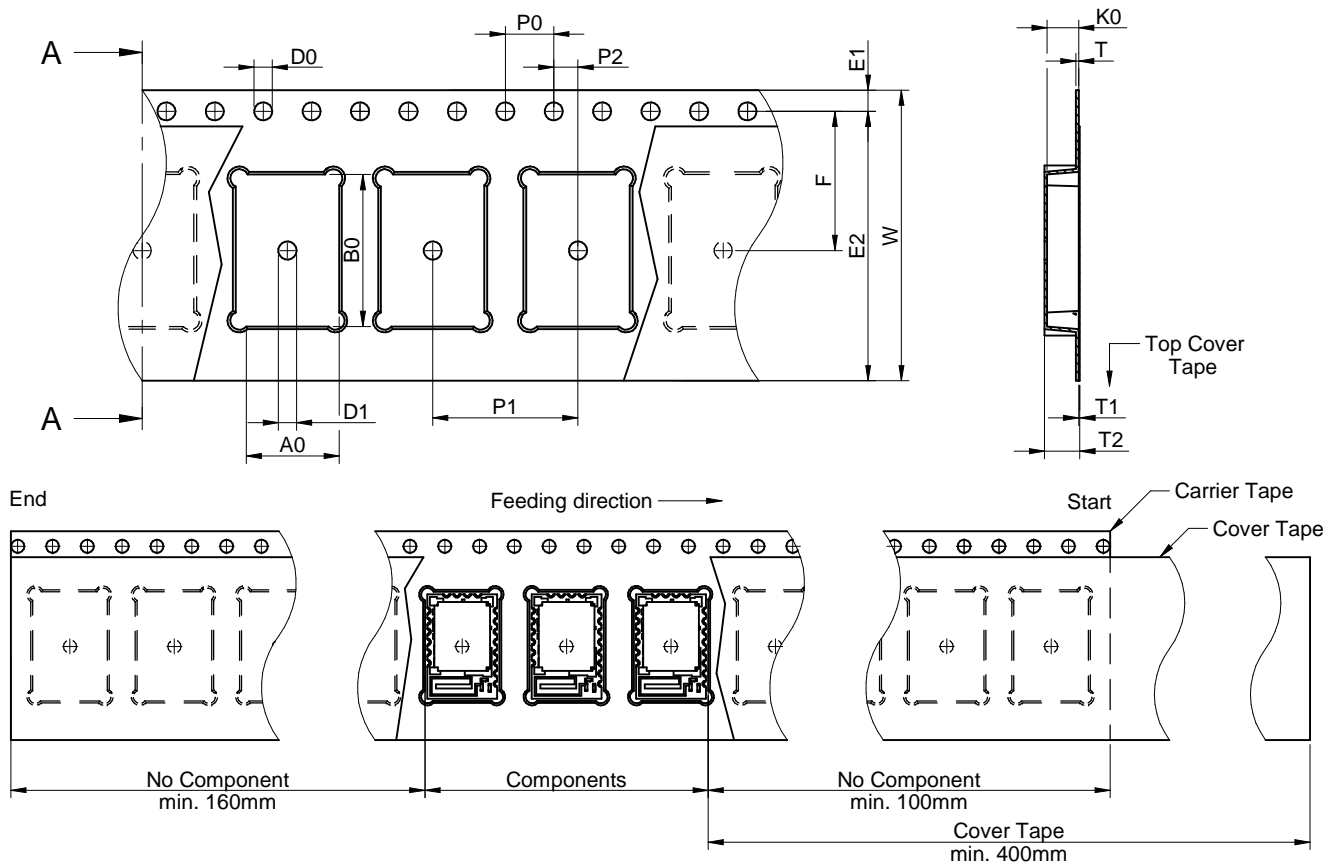

	Tape Type	A0 (mm)	B0 (mm)	W (mm)	T (mm)	T1 (mm)	T2 (mm)	K0 (mm)	P0 (mm)	P1 (mm)	P2 (mm)	D0 (mm)	D1 (mm)	E1 (mm)	E2 (mm)	F (mm)	Material	Qty. (pcs.)
Tolerance		±0.1	±0.1	+0.3/-0.1	±0.03	ref.	typ.	±0.1	±0.1	±0.1	±0.1	+0.1/-0.0	min.	±0.1	min.	±0.1		
Value	2a	8,55	12,55	24,00	0,30	0,10	3,00	2,60	4,00	12,00	2,00	1,50	1,50	1,75	22,25	11,50	Polystyrene	

	A (mm)	B (mm)	C (mm)	D (mm)	N (mm)	W1 (mm)	W2 (mm)	W3 (mm)	W3 (mm)	Material
Tolerance	± 2,0	min.	min.	min.	min.	+ 2,0	max.	min.	max.	
Value	178,00	1,50	12,80	20,20	60,00	24,40	30,40	23,90	27,40	Polystyrene

RoHS COMPLIANT  
REACH COMPLIANT

**WÜRTH ELEKTRONIK**

Würth Elektronik eiSos GmbH & Co. KG  
EMC & Inductive Solutions  
Max-Eyth-Str. 1  
74638 Waldenburg  
Germany  
Tel. +49 (0) 79 42 945 - 0  
www.we-online.com  
eiSos@we-online.com

CHECKED JaC	REVISION 001.000	DATE (YYYY-MM-DD) 2021-06-22	GENERAL TOLERANCE DIN ISO 2768-1m	PROJECTION METHOD 
DESCRIPTION <b>WIRL-COMB Setebos-I Combined Proprietary 2.4GHz &amp; BTLE module T&amp;R</b>			ORDER CODE <b>2611011024020</b>	
BUSINESS UNIT eiSmart		STATUS Valid	PAGE 4/7	

This electronic component has been designed and developed for usage in general electronic equipment only. This product is not authorized for use in equipment where a higher safety standard and reliability standard is especially required or where a failure of the product is reasonably expected to cause severe personal injury or death, unless the parties have executed an agreement specifically governing such use. Moreover Würth Elektronik eiSos GmbH & Co KG products are neither designed nor intended for use in areas such as military, aerospace, aviation, nuclear control, submarine, transportation (automotive control, train control, ship control), transportation signal, disaster prevention, medical, public information network etc. Würth Elektronik eiSos GmbH & Co KG must be informed about the intent of such usage before the design-in stage. In addition, sufficient reliability evaluation checks for safety must be performed on every electronic component which is used in electrical circuits that require high safety and reliability functions or performance.

## Classification Reflow Profile for SMT components:



## Classification Reflow Soldering Profile:

Profile Feature		Value
Preheat Temperature Min	$T_{s \text{ min}}$	150 °C
Preheat Temperature Max	$T_{s \text{ max}}$	200 °C
Preheat Time $t_s$ from $T_{s \text{ min}}$ to $T_{s \text{ max}}$	$t_s$	60 - 120 seconds
Ramp-up Rate ( $T_L$ to $T_p$ )		3 °C/ second max.
Liquidous Temperature	$T_L$	217 °C
Time $t_L$ maintained above $T_L$	$t_L$	60 - 150 seconds
Peak package body temperature	$T_p$	260 °C
Time within 5°C of actual peak temperature	$t_p$	20 - 30 seconds
Ramp-down Rate ( $T_p$ to $T_L$ )		6 °C/ second max.
Time 25°C to peak temperature		8 minutes max.

refer to IPC/ JEDEC J-STD-020E

	CHECKED	REVISION	DATE (YYYY-MM-DD)	GENERAL TOLERANCE	PROJECTION METHOD
	JaC	001.000	2021-06-22	DIN ISO 2768-1m	
	DESCRIPTION				ORDER CODE
	<b>WIRL-COMB Setebos-I Combined Proprietary 2.4GHz &amp; BTLE module T&amp;R</b>				<b>2611011024020</b>
WÜRTH Elektronik eiSos GmbH & Co. KG EMC & Inductive Solutions Max-Eyth-Str. 1 74638 Waldenburg Germany Tel. +49 (0) 79 42 945 - 0 www.we-online.com eiSos@we-online.com			BUSINESS UNIT	STATUS	PAGE
			eiSmart	Valid	5/7

## Cautions and Warnings:

### The following conditions apply to all goods within the product series of wireless connectivity of Würth Elektronik eiSos GmbH & Co. KG:

#### General:

- This electronic component is designed and developed with the intention for use in general electronic equipment.
- Würth Elektronik must be asked for written approval (following the PPAP procedure) before incorporating the components into any equipment in fields such as military, aerospace, aviation, nuclear control, submarine, transportation (automotive control, train control, ship control), transportation signal, disaster prevention, medical, public information network, etc. where higher safety and reliability are especially required and/or if there is the possibility of direct damage or human injury.
- Electronic components that will be used in safety-critical or high-reliability applications, should be pre-evaluated by the customer.
- The component is designed and manufactured to be used within the datasheet specified values. If the usage and operation conditions specified in the datasheet are not met, the wire insulation may be damaged or dissolved.
- Do not drop or impact the components, the component may be damaged.
- Würth Elektronik products are qualified according to international standards, which are listed in each product reliability report. Würth Elektronik does not guarantee any customer qualified product characteristics beyond Würth Elektronik's specifications, for its validity and sustainability over time.
- The responsibility for the applicability of the customer specific products and use in a particular customer design is always within the authority of the customer. All technical specifications for standard products also apply to customer specific products.

#### Product specific:

#### Soldering:

- The solder profile must comply with the technical product specifications. All other profiles will void the warranty.
- All other soldering methods are at the customer's own risk.

#### Cleaning and Washing:

- Washing agents used during the production to clean the customer application might damage or change the characteristics of the component. Washing agents may have a negative effect on the long-term functionality of the product.
- Using a brush during the cleaning process could break the module. Therefore, we do not recommend using a brush during the PCB cleaning process.

#### Potting and Coating:

- If the product is potted in the customer application, the potting material might shrink or expand during and after hardening. Shrinking could lead to an incomplete seal, allowing contaminants into the component. Expansion could damage components. We recommend a manual inspection after potting to avoid these effects.

- Conformal coating or potting results in loss of warranty.
- The RF shield will not protect the part from low-viscosity coatings and potting. An undefined amount of coating and potting will enter inside the shielding.
- Conformal coating and potting will influence the parts of the radio front end and consequently influence the radio performance.
- Potting will influence the temperature behaviour of the device. This might be critical for components with high power.

#### Storage Conditions:



- A storage of Würth Elektronik products for longer than 12 months is not recommended. Within other effects, the terminals may suffer degradation, resulting in bad solderability. Therefore, all products shall be used within the period of 12 months based on the day of shipment.
- Do not expose the components to direct sunlight.
- The storage conditions in the original packaging are defined according to DIN EN 61760-2.
- If there is a moisture sensitive component, the storage condition in the original packaging is defined according to IPC/JEDEC-J-STD-033. It is also recommended to return the component to the original moisture proof bag and reseal the moisture proof bag again.
- ESD prevention methods need to be followed for manual handling and processing by machinery.
- The storage conditions stated in the original packaging apply to the storage time and not to the transportation time of the components.

#### Handling:

- Violation of the technical product specifications such as exceeding the nominal rated current, will void the warranty.
- Violation of the technical product specifications such as but not limited to exceeding the absolute maximum ratings will void the conformance to regulatory requirements.
- The edge castellation is designed and made for prototyping, i.e. hand soldering purposes only.
- Non-antenna modules must be equipped with a proper antenna having specific characteristics.
- The applicable country regulations and specific environmental regulations must be observed.
- Do not disassemble the product. Evidence of tampering will void the warranty.
- The temperature rise of the component must be taken into consideration. The operating temperature is comprised of ambient temperature and temperature rise of the component. The operating temperature of the component shall not exceed the maximum temperature specified.

These cautions and warnings comply with the state of the scientific and technical knowledge and are believed to be accurate and reliable. However, no responsibility is assumed for inaccuracies or incompleteness.

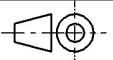
All topics are described in a more detailed manner in the manual for each product.

	CHECKED	REVISION	DATE (YYYY-MM-DD)	GENERAL TOLERANCE	PROJECTION METHOD	
	JaC	001.000	2021-06-22	DIN ISO 2768-1m		
	DESCRIPTION				ORDER CODE	
	<b>WIRL-COMB Setebos-I Combined Proprietary 2.4GHz &amp; BTLE module T&amp;R</b>				<b>2611011024020</b>	
Würth Elektronik eiSos GmbH & Co. KG EMC & Inductive Solutions Max-Eyth-Str. 1 74638 Waldenburg Germany Tel. +49 (0) 79 42 945 - 0 www.we-online.com eiSos@we-online.com			BUSINESS UNIT	STATUS	PAGE	
			eiSmart	Valid	6/7	

## Important Notes

The following conditions apply to all goods within the product range of Würth Elektronik eiSos GmbH & Co. KG:

### 1. General Customer Responsibility

Some goods within the product range of Würth Elektronik eiSos GmbH & Co. KG contain statements regarding general suitability for certain application areas. These statements about suitability are based on our knowledge and experience of typical requirements concerning the areas, serve as general guidance and cannot be estimated as binding statements about the suitability for a customer application. The responsibility for the applicability and use in a particular customer design is always solely within the authority of the customer. Due to this fact it is up to the customer to evaluate, where appropriate to investigate and decide whether the device with the specific product characteristics described in the product specification is valid and suitable for the respective customer application or not.

### 2. Customer Responsibility related to Specific, in particular Safety-Relevant Applications

It has to be clearly pointed out that the possibility of a malfunction of electronic components or failure before the end of the usual lifetime cannot be completely eliminated in the current state of the art, even if the products are operated within the range of the specifications. In certain customer applications requiring a very high level of safety and especially in customer applications in which the malfunction or failure of an electronic component could endanger human life or health it must be ensured by most advanced technological aid of suitable design of the customer application that no injury or damage is caused to third parties in the event of malfunction or failure of an electronic component. Therefore, customer is cautioned to verify that data sheets are current before placing orders. The current data sheets can be downloaded at [www.we-online.com](http://www.we-online.com).

### 3. Best Care and Attention

Any product-specific notes, cautions and warnings must be strictly observed. Any disregard will result in the loss of warranty.

### 4. Customer Support for Product Specifications

Some products within the product range may contain substances which are subject to restrictions in certain jurisdictions in order to serve specific technical requirements. Necessary information is available on request. In this case the field sales engineer or the internal sales person in charge should be contacted who will be happy to support in this matter.

### 5. Product R&D

Due to constant product improvement product specifications may change from time to time. As a standard reporting procedure of the Product Change Notification (PCN) according to the JEDEC-Standard inform about minor and major changes. In case of further queries regarding the PCN, the field sales engineer or the internal sales person in charge should be contacted. The basic responsibility of the customer as per Section 1 and 2 remains unaffected.

## 6. Product Life Cycle



Due to technical progress and economical evaluation we also reserve the right to discontinue production and delivery of products. As a standard reporting procedure of the Product Termination Notification (PTN) according to the JEDEC-Standard we will inform at an early stage about inevitable product discontinuance. According to this we cannot guarantee that all products within our product range will always be available. Therefore it needs to be verified with the field sales engineer or the internal sales person in charge about the current product availability expectancy before or when the product for application design-in disposal is considered. The approach named above does not apply in the case of individual agreements deviating from the foregoing for customer-specific products.

## 7. Property Rights

All the rights for contractual products produced by Würth Elektronik eiSos GmbH & Co. KG on the basis of ideas, development contracts as well as models or templates that are subject to copyright, patent or commercial protection supplied to the customer will remain with Würth Elektronik eiSos GmbH & Co. KG. Würth Elektronik eiSos GmbH & Co. KG does not warrant or represent that any license, either expressed or implied, is granted under any patent right, copyright, mask work right, or other intellectual property right relating to any combination, application, or process in which Würth Elektronik eiSos GmbH & Co. KG components or services are used.

## 8. General Terms and Conditions

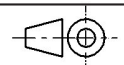
Unless otherwise agreed in individual contracts, all orders are subject to the current version of the "General Terms and Conditions of Würth Elektronik eiSos Group", last version available at [www.we-online.com](http://www.we-online.com).

	CHECKED	REVISION	DATE (YYYY-MM-DD)	GENERAL TOLERANCE	PROJECTION METHOD	
	JaC	001.000	2021-06-22	DIN ISO 2768-1m		
	<b>WIRL-COMB Setebos-I Combined Proprietary 2.4GHz &amp; BTLE module T&amp;R</b>				ORDER CODE	
	Würth Elektronik eiSos GmbH & Co. KG EMC & Inductive Solutions Max-Eyth-Str. 1 74638 Waldenburg Germany Tel. +49 (0) 79 42 945 - 0 <a href="http://www.we-online.com">www.we-online.com</a> <a href="mailto:eiSos@we-online.com">eiSos@we-online.com</a>				<b>2611011024020</b>	
				BUSINESS UNIT	STATUS	PAGE
				eiSmart	Valid	7/7