

# Agilent HCPL-181 Phototransistor Optocoupler SMD Mini-Flat Type Data Sheet

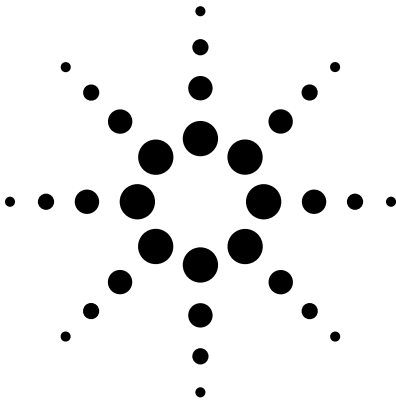

## Description

The HCPL-181 contains a light emitting diode optically coupled to a phototransistor. It is packaged in a 4-pin mini-flat SMD package with a 2.0 mm profile. The small dimension of this product allows significant space saving. The package volume is 30% smaller than that of conventional DIP type. Input-output isolation voltage is 3750 Vrms. Response time,  $t_r$ , is typically 4  $\mu$ s and minimum CTR is 50% at input current of 5 mA.

## Ordering Information

Specify part number followed by Option Number (if desired).

HCPL-181-XXXXE

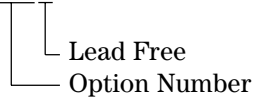

- 000 = No Options
- 060 = IEC/EN/DIN EN 60747-5-2 Option
- 00A = Rank Mark A
- 00B = Rank Mark B
- 00C = Rank Mark C
- 00D = Rank Mark D

## Features

- **Current Transfer Ratio**  
(CTR: min. 50% at  $I_F = 5$  mA,  $V_{CE} = 5$  V)
- **High input-output isolation voltage**  
( $V_{iso} = 3750$  Vrms)
- **High collector-emitter voltage** ( $V_{CEO} = 80$  V)
- **Response time** ( $t_r$ : typ., 4  $\mu$ s at  $V_{CE} = 2$  V,  $I_C = 2$  mA,  $R_L = 100 \Omega$ )
- **Mini-flat package (2.0 mm profile) in tape and reel package**
- **UL approved**
- **CSA approved**
- **IEC/EN/DIN EN 60747-5-2 approved**
- **Options available:**  
– IEC/EN/DIN EN 60747-5-2 approvals (060)

## Functional Diagram

PIN NO. AND INTERNAL CONNECTION DIAGRAM

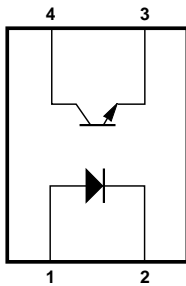

- 1. ANODE      3. EMITTER
- 2. CATHODE    4. COLLECTOR

## Schematic

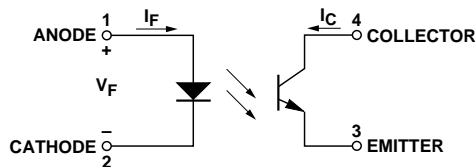

## Applications

- I/O interfaces for computers
- System appliances, measuring instruments
- Signal transmission between circuits of different potentials and impedances
- Feedback circuit in power supply

**CAUTION:** It is advised that normal static precautions be taken in handling and assembly of this component to prevent damage and/or degradation which may be induced by ESD.

## Package Outline Drawings

### HCPL-181-000E

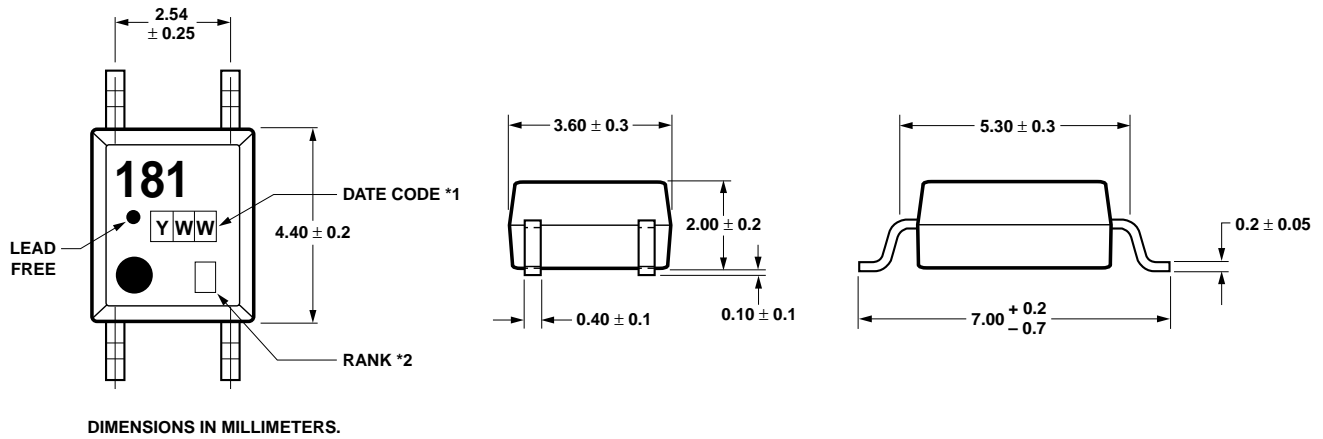

### HCPL-181-060E

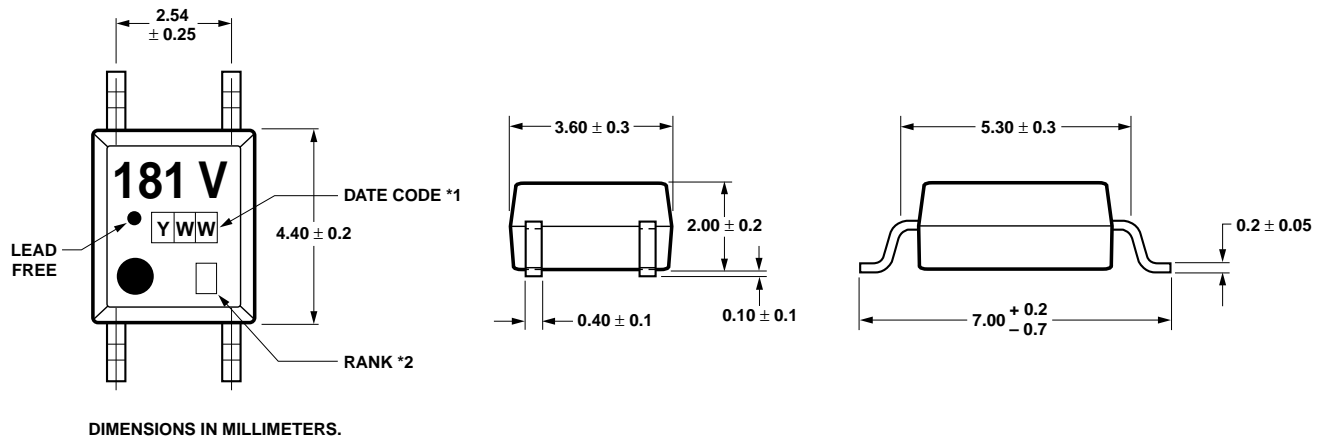

## Solder Reflow Temperature Profile

- 1) One-time soldering reflow is recommended within the condition of temperature and time profile shown at right.
- 2) When using another soldering method such as infrared ray lamp, the temperature may rise partially in the mold of the device. Keep the temperature on the package of the device within the condition of (1) above.

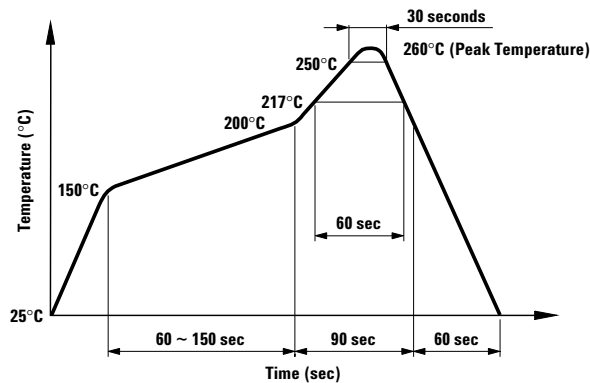

### Absolute Maximum Ratings (T<sub>A</sub> = 25°C)

Storage Temperature, T <sub>S</sub>	-55°C to +155°C
Operating Temperature, T <sub>A</sub>	-55°C to +100°C
Lead Solder Temperature, max. (1.6 mm below seating plane)	260°C for 10 s
Average Forward Current, I <sub>F</sub>	50 mA
Reverse Input Voltage, V <sub>R</sub>	6 V
Input Power Dissipation, P <sub>I</sub>	70 mW
Collector Current, I <sub>C</sub>	50 mA
Collector-Emitter Voltage, V <sub>CE0</sub>	80 V
Emitter-Collector Voltage, V <sub>ECO</sub>	6 V
Collector Power Dissipation	150 mW
Total Power Dissipation	170 mW
Isolation Voltage, V <sub>iso</sub> (AC for 1 minute, R.H. = 40 ~ 60%)	3750 Vrms

Rank Mark	CTR (%)	Conditions
A	80 ~ 160	I <sub>F</sub> = 5 mA, V <sub>CE</sub> = 5 V, T <sub>A</sub> = 25°C
B	130 ~ 260	
C	200 ~ 400	
D	300 ~ 600	

### Electrical Specifications (T<sub>A</sub> = 25°C)

Parameter	Symbol	Min.	Typ.	Max.	Units	Test Conditions
Forward Voltage	V <sub>F</sub>	—	1.2	1.4	V	I <sub>F</sub> = 20 mA
Reverse Current	I <sub>R</sub>	—	—	10	μA	V <sub>R</sub> = 4 V
Terminal Capacitance	C <sub>t</sub>	—	30	250	pF	V = 0, f = 1 KHz
Collector Dark Current	I <sub>CEO</sub>	—	—	100	nA	V <sub>CE</sub> = 20 V
Collector-Emitter Breakdown Voltage	BV <sub>CEO</sub>	80	—	—	V	I <sub>C</sub> = 0.1 mA, I <sub>F</sub> = 0
Emitter-Collector Breakdown Voltage	BV <sub>ECO</sub>	6	—	—	V	I <sub>E</sub> = 10 μA, I <sub>F</sub> = 0
Collector Current	I <sub>C</sub>	2.5	—	30	mA	I <sub>F</sub> = 5 mA, V <sub>CE</sub> = 5 V
*Current Transfer Ratio	CTR	50	—	600	%	
Collector-Emitter Saturation Voltage	V <sub>CE(sat)</sub>	—	—	0.2	V	I <sub>F</sub> = 20 mA, I <sub>C</sub> = 1 mA
Response Time (Rise)	t <sub>r</sub>	—	4	18	μs	V <sub>CC</sub> = 2 V, I <sub>C</sub> = 2 mA
Response Time (Fall)	t <sub>f</sub>	—	3	18	μs	R <sub>L</sub> = 100 Ω
Isolation Resistance	R <sub>iso</sub>	5 × 10 <sup>10</sup>	1 × 10 <sup>11</sup>	—	Ω	DC 500 V 40 ~ 60% R.H.
Floating Capacitance	C <sub>f</sub>	—	0.6	1.0	pF	V = 0, f = 1 MHz

$$* \text{CTR} = \frac{I_C}{I_F} \times 100\%$$

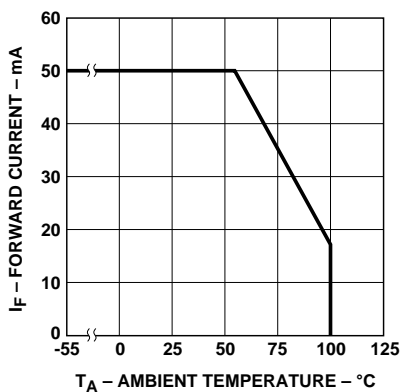

Figure 1. Forward current vs. temperature.

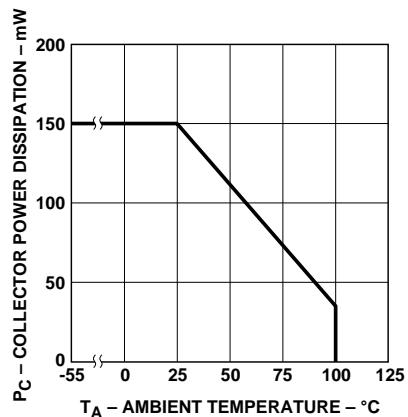

Figure 2. Collector power dissipation vs. temperature.

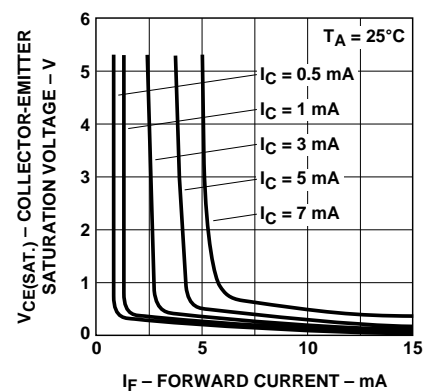

Figure 3. Collector-emitter saturation voltage vs. forward current.

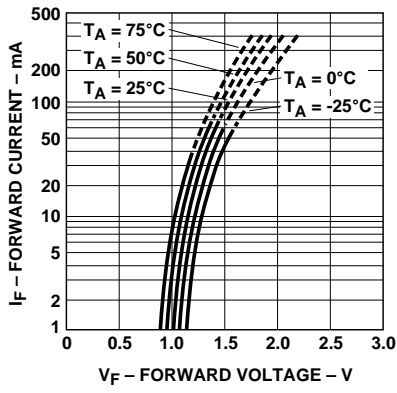

Figure 4. Forward current vs. forward voltage.

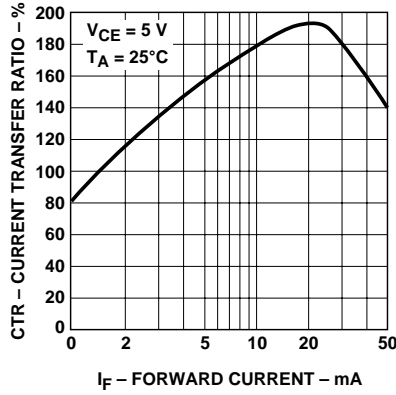

Figure 5. Current transfer ratio vs. forward current.

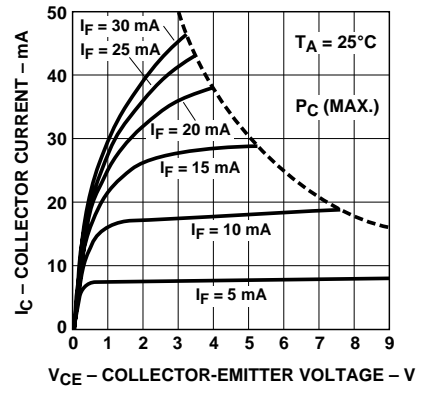

Figure 6. Collector current vs. collector-emitter voltage.

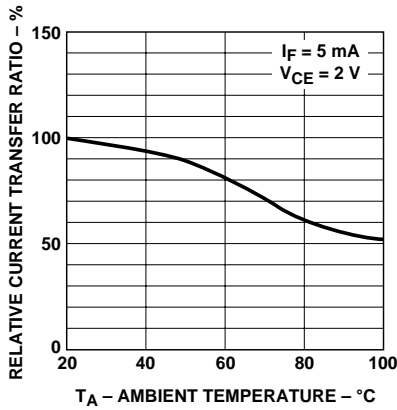

Figure 7. Relative current transfer ratio vs. temperature.

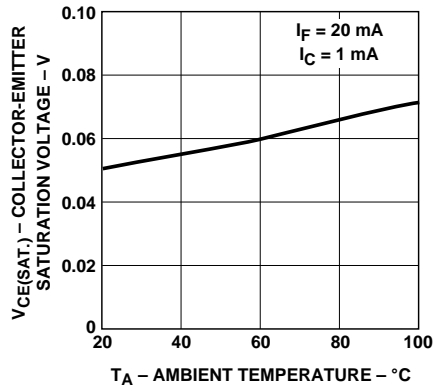

Figure 8. Collector-emitter saturation voltage vs. temperature.

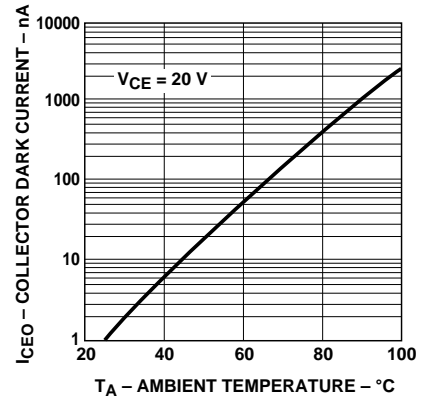

Figure 9. Collector dark current vs. temperature.

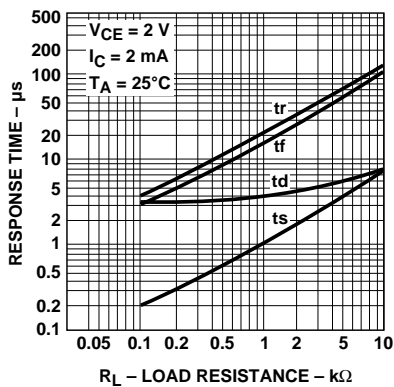

Figure 10. Response time vs. load resistance.

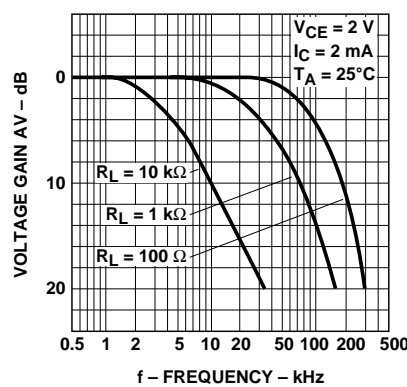
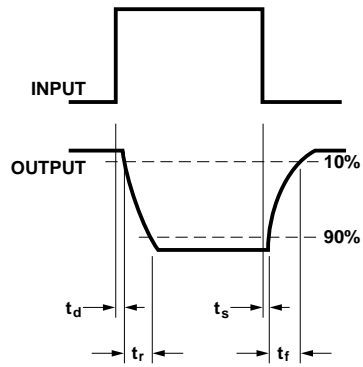
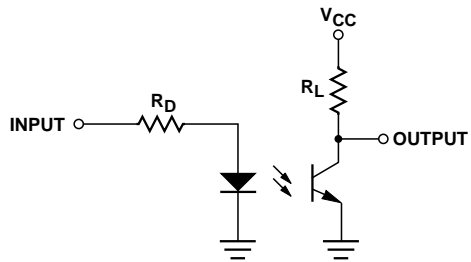
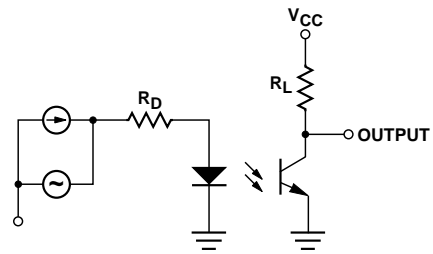

Figure 11. Frequency response.

### Test Circuit for Response Time



### Test Circuit for Frequency Response



**[www.agilent.com/semiconductors](http://www.agilent.com/semiconductors)**

For product information and a complete list of distributors, please go to our web site.

For technical assistance call:

Americas/Canada: +1 (800) 235-0312 or (916) 788-6763

Europe: +49 (0) 6441 92460

China: 10800 650 0017

Hong Kong: (+65) 6756 2394

India, Australia, New Zealand: (+65) 6755 1939

Japan: (+81 3) 3335-8152 (Domestic/International), or 0120-61-1280 (Domestic Only)

Korea: (+65) 6755 1989

Singapore, Malaysia, Vietnam, Thailand, Philippines, Indonesia: (+65) 6755 2044

Taiwan: (+65) 6755 1843

Data subject to change.

Copyright © 2004 Agilent Technologies, Inc.

Obsoletes 5989-0306EN

October 27, 2004

5989-1738EN



**Agilent Technologies**