

Features:

- 10W Small Compact SIP style AC-DC converter
- Wide AC & DC Input 85V to 305VAC, 70-430VDC
- Temperature Range -40°C to +85°C
- EMC Compliant with external components
- Output Range: 3.3V - 24VDC
- Low Standby Power 0.1W
- Fully Isolated Pri - Sec >3000Vrms
- Safety: Class II
- Materials: UL94-V0
- IEC/EN/UL62368, IEC/EN61558, IEC/EN60335
- 3 Year Warranty



Description

VTX-215-010-0## is a compact SIP style AC-DC power converter. It They feature wide input range accepting either AC or DC voltage, high efficiency, low power consumption and CLASS II reinforced insulation. All models are particularly suitable for industrial control, electric power, instrumentation and smart home applications which don't have high requirement for dimension. A variety of EMC external circuits meet the needs of multiple industries we recommend using the application circuit show in this Datasheet or contact our Technical team for further support.

Selection Guide

Part Number	Power Rating Watts	Output Voltage (VDC)	Output Current (mA)	Capacitive Load (uF)	Ambient Temp. (°C)	Efficiency Typical	Input Range
VTX-215-010-003	6.6	3.3	2000	1500	85°C	>73%	85 - 305VAC (70 - 430VDC)
VTX-215-010-005	10	5	2000	1500			
VTX-215-010-009	10	9	1100	1000			
VTX-215-010-012	10	12	830	680			
VTX-215-010-015	10	15	670	470			
VTX-215-010-024	10	24	420	330			
Note: Other output voltages are available upon request.							

Please contact Vigortronix for any enquiries. Products can be altered to suit custom requirements.
The information contained in this document is subject to change without notice.

Input Specification					
Item	Conditions	Min	Typical	Max	Unit
Input Voltage	AC Input	85	-	305	VAC
	DC Input	70	-	430	VDC
Input Frequency		47	-	63	Hz
Input Current	115VAC	-	-	0.3	A
	230VAC	-	-	0.18	
Inrush Current	115VAC	-	15	-	
	230VAC	-	30	-	
External Input Fuse		1Amp Slow Blow Fuse			

Output Specification					
Item	Conditions	Min	Typical	Max	Unit
Output Voltage	10% - 100% Load	-	+/-3	-	%
Line Regulation	Full Load	-	+/-1	-	
Load Regulation	10% - 100% Load	-	+/-1.5	-	
Ripple / Noise	20MHz Bandwidth (Peak to Peak Value)	-	80	150	mV
Stand by Power	230VAC	-	0.10	0.15	W
Temp. Coefficient		-	+/-0.15	-	%/°C
Short Circuit Protection		Hiccup, Continuous, Self-recovery			
Over Current Protection		>110 Load, Self-recovery			
Minimum Load		0	-	-	%
Hold-up Time	230VAC Input	150	180	-	mS

Please contact Vigortronix for any enquiries. Products can be altered to suit custom requirements.
The information contained in this document is subject to change without notice.

General Specification					
Item	Conditions	Min	Typical	Max	Unit
Dielectric Strength	Input to Output (1Min, 5mA)	3600	-	-	VAC
Insulation Resistance	Input to Output (500VDC)	100			M.Ohm
Operating Temperature		-40	-	+85	°C
Storage Temperature		-40	-	+105	
Storage Humidity		-	-	+95	%RH
Switching Frequency		-	-	-	KHz
Safety Class		CLASS II			
MTBF		>1,000KHrs @ 25°C (MIL-HDBK-217F)			
Safety Approvals		IEC/EN/UL62368 Compliant: IEC/EN61558, IEC/EN60335			
Cooling Method		Free air convection			
Dimensions		32.0 x 17.20 x 15.05mm			
Weight		8.2g			

EMC Specification		
Emissions	CE /RE	CISPR32 / EN55032 CLASS A/B EN55014-1
Immunity	ESD	IEC/EN 61000-4-2 CONTACT +/-6KV EN55014-2
	RS	IEC/EN 61000-4-3 10V/m EN55014-2
	EFT	IEC/EN 61000-4-4
	SURGE	IEC/EN 61000-4-5, EN55014-2
	CS	IEC/EN 61000-4-6 10V/r.m.s. EN55014-2
	Voltage Variation	IEC/EN 61000-4-11, EN55014-2

Please contact Vigortronix for any enquiries. Products can be altered to suit custom requirements.
The information contained in this document is subject to change without notice.

Derating Graphs

Temperature Derating Graph

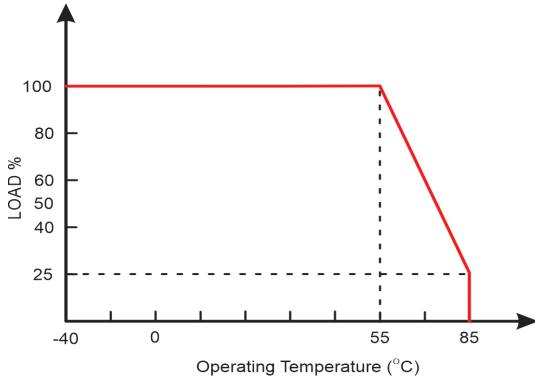

Input Voltage Derating Graph

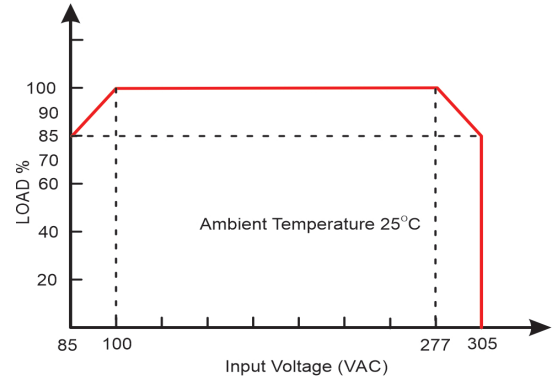

Application Schematic for EMC

Typical Application

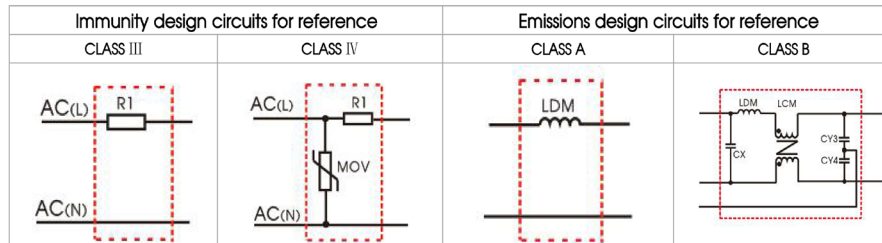
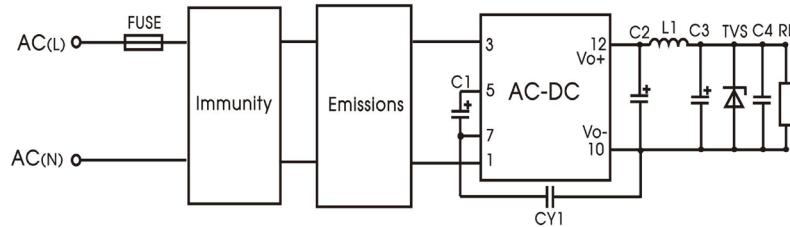

Part Number	C1	C2 (Solid State)	L1	C3	C4	CY1	TVS	Fuse	MOV
VTX-215-010-003	22uF/ 450V	820uF/6.3V	2.2uH Max 15m Ω	150uF/ 35V	0.1uF/ 50V	1.0nF/ 400V	SMBJ7.0A	1Amp/ 300V Slow Blow	S14K350
VTX-215-010-005		820uF/16V					SMBJ7.0A		
VTX-215-010-009		270uF/16V					SMBJ12A		
VTX-215-010-012		270uF/16V		SMBJ20A					
VTX-215-010-015		470uF/35V		SMBJ20A					
VTX-215-010-024		470uF/35V		SMBJ30A					

Note: For additional filtering requirements, contact technical support

- C1 is used as filter capacitor with AC input (must be connected externally) and as EMC filter capacitor with DC input (must be connected), and it is recommended to use the capacitor with ripple current >300mA@100KHz.
- We recommend using an electrolytic capacitor with high frequency and low ESR (ESR of C3 at low temperature of -40°C≤1.1Ω) rating for C3 (refer to manufacture's datasheet), electrolytic capacitor can be used for C2 when applied in normal and high temperature environments. Combined with C2, L1, they form a pi-type filter circuit. Choose a capacitor voltage rating with at least 20% margin, in other words not exceeding 80%. C4 is a ceramic capacitor, used for filtering high frequency noise.
- A suppressor diode (TVS) is recommended to protect the application in case of converter failure and specification should be 1.2 times of the output voltage.

Please contact Vigortronix for any enquiries. Products can be altered to suit custom requirements.

The information contained in this document is subject to change without notice.

Dimensions

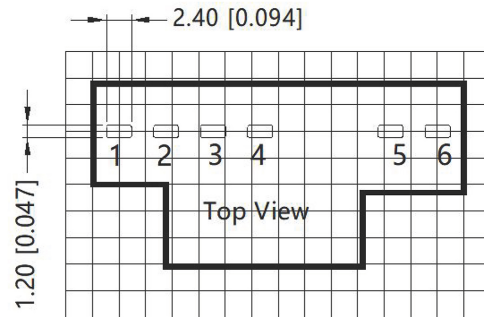
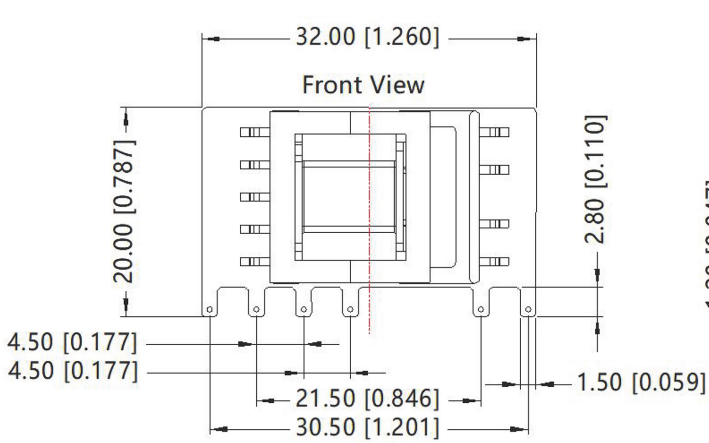

Note: Grid 2.54*2.54mm

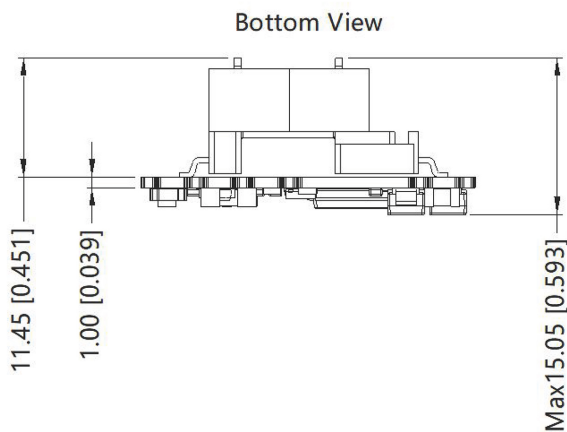

Pin-Out	
Pin	Mark
1	AC(N)
2	AC(L)
3	+V(CAP)
4	-V(CAP)
5	-Vo
6	+Vo

Note:
 Unit: mm[inch]
 General tolerances: $\pm 1.00[\pm 0.039]$
 The layout of the device is for reference only, please refer to the actual product

Please contact Vigortronix for any enquiries. Products can be altered to suit custom requirements.
 The information contained in this document is subject to change without notice.