



Polamco | Polamco Braid Tail Backshell

TE Internal #: BAE0164-00

Polamco Braid Tail Backshell, Ruggedized Backshells & Adapters, Aluminum, Cadmium, Cable Diameter Range 0 – 6.3 mm, 90, Braided

[View on TE.com >](#)

Connectors > Connector Backshells & Adapters > Ruggedized Backshells & Adapters



Backshell Material: **Aluminum**  
 Adapter Plating Material: **Cadmium**  
 Cable Diameter Range: **0 – 6.3 mm**  
 Adapter Angle: **90**  
 Termination Device Type: **Braided**

**Features**

**Product Type Features**

Adapter Angle	90
Termination Device Type	Braided
Connector Shell Size	11

**Body Features**

Color	Olive Drab
Backshell Material	Aluminum
Adapter Plating Material	Cadmium
Adapter Entry Size	04

**Dimensions**

Cable Diameter Range	0 – 6.3 mm
----------------------	------------

**Usage Conditions**

Salt Spray Resistance	500 Hr
Operating Temperature Range	-65 – 175 °C[-85 – 347 °F]



## Product Compliance

[For compliance documentation, visit the product page on TE.com>](#)

EU RoHS Directive 2011/65/EU	Not Yet Reviewed
EU ELV Directive 2000/53/EC	Not Yet Reviewed
China RoHS 2 Directive MIIT Order No 32, 2016	Not reviewed for China RoHS compliance
EU REACH Regulation (EC) No. 1907/2006	<p>Current ECHA Candidate List: JUL 2021 (219)</p> <p>Candidate List Declared Against: JUL 2021 (219)</p> <p>SVHC &gt; Threshold:</p> <p>Pb (.3% in BODY &amp; NUT)</p> <p>Cd (3% in BODY &amp; NUT)</p> <p><b>Article Safe Usage Statements:</b>                      Use personal protective equipment as required. Do not eat, drink or smoke when using this product. Wash thoroughly after handling. Recycle if possible and dispose of the article by following all applicable governmental regulations relevant to your geographic location.</p>
Halogen Content	Not Yet Reviewed for halogen content
Solder Process Capability	Not reviewed for solder process capability

### Product Compliance Disclaimer

This information is provided based on reasonable inquiry of our suppliers and represents our current actual knowledge based on the information they provided. This information is subject to change. The part numbers that TE has identified as EU RoHS compliant have a maximum concentration of 0.1% by weight in homogenous materials for lead, hexavalent chromium, mercury, PBB, PBDE, DBP, BBP, DEHP, DIBP, and 0.01% for cadmium, or qualify for an exemption to these limits as defined in the Annexes of Directive 2011/65/EU (RoHS2). Finished electrical and electronic equipment products will be CE marked as required by Directive 2011/65/EU. Components may not be CE marked. Additionally, the part numbers that TE has identified as EU ELV compliant have a maximum concentration of 0.1% by weight in homogenous materials for lead, hexavalent chromium, and mercury, and 0.01% for cadmium, or qualify for an exemption to these limits as defined in the Annexes of Directive 2000/53/EC (ELV). Regarding the REACH Regulation, the information TE provides on SVHC in articles for this part number is based on the latest European Chemicals Agency (ECHA) 'Guidance on requirements for substances in articles' posted at this URL: <https://echa.europa.eu/guidance-documents/guidance-on-reach>

## Compatible Parts



Also in the Series | [Polamco Braid Tail Backshell](#)



Ruggedized Backshells & Adapters(78)

## Customers Also Bought

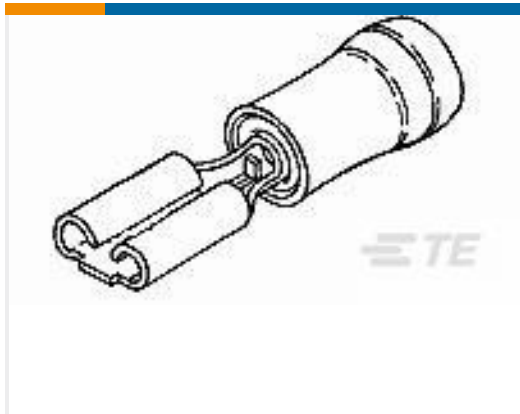

TE Part #165616-5  
110 PIDG FASTON REC



TE Part #7-1676123-7  
1/2W SM M/OX 5% 1K2



TE Part #7-1676123-9  
1/2W SM M/OX 5% 1K5



TE Part #6-1676123-0  
1/2W SM M/OX 5% 240R

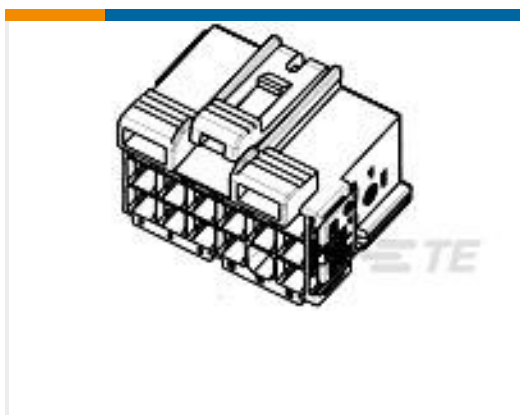

TE Part #1241581-2  
JUN-POW-TIM GEH 17P



TE Part #926647-2  
15P UN-MNL AUFN-GEH



TE Part #YAFD54-12-10SNC127  
RECP ASSY



TE Part #YAFD57-12-10PNC127  
PLUG ASSY



TE Part #5054324002  
RNF-100-1-1/2-3-SP

## Documents

### Product Drawings

[70H3-11-04-1-B-SE](#)

English

### Datasheets & Catalog Pages

[MATERIAL AND FINISH DETAILS](#)

English