



3D Printing Brass Nozzle 1 PCS

Smooth inner wall without glitches, smoother filament-pushing

Nose with chamfer, Round nozzle

MFR: 4004020008

Item Number: D6-0.5mm

3D PRINTING BRASS NOZZLE

Delicate workmanship | Smooth filament–pushing | Precise molding



International brass

Better thermal conductivity
higher hardness



Narrow-nosed nozzle

Chamfering Craft



Smooth inner wall

Without glitches



Even filament–pushing

No more and no less



High–end Craft

Excellent quality



All Series

Various models available

Nozzle anatomy

Name: Brass nozzle

Material: International brass

Size: 6mm*13mm

Compatible filament size:1.75

Compatible nozzle tip size: 0.1,0.2,0.3,0.4,0.5,0.6,0.8,1.0,1.2mm

1.75mm filament apply to nozzle of 2.0mm inner diameter

3.0mm filament apply to nozzle of 3.2mm inner diameter

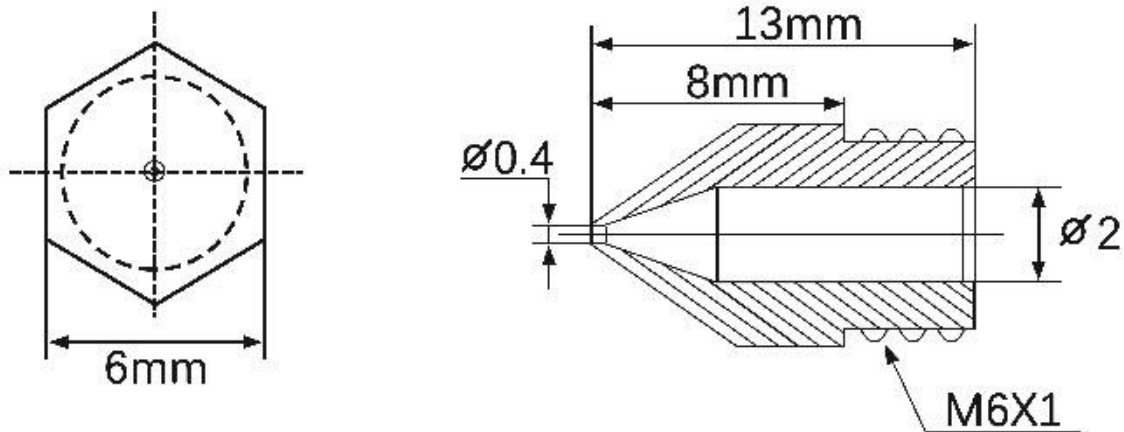

International brass craft Better thermal conductivity, higher hardness

Print better quality with excellent thermal conductivity and wear-resistant

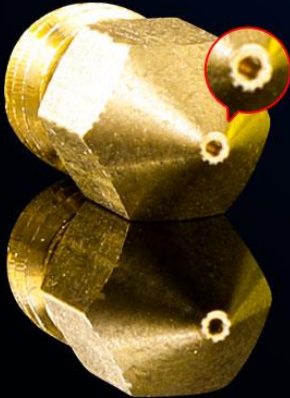

Common nozzle ❌



International brass nozzle ✅



Most flaws is appeared if model printed with common nozzle



VS



Smooth surface if model printed with international brass nozzle



Smooth inner wall without glitches Smoother filament–pushing

Smooth inner wall without glitches, low viscosity, and smoother filament–hopper
Meanwhile, the craft that the model printed with common nozzle is not mature enough
Rough inner wall and concave convex surface make filament come out unsmoothly

Smooth inner wall
smoother filament–pushing

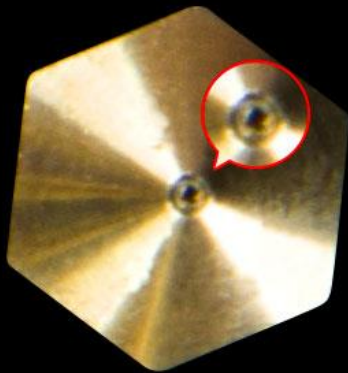
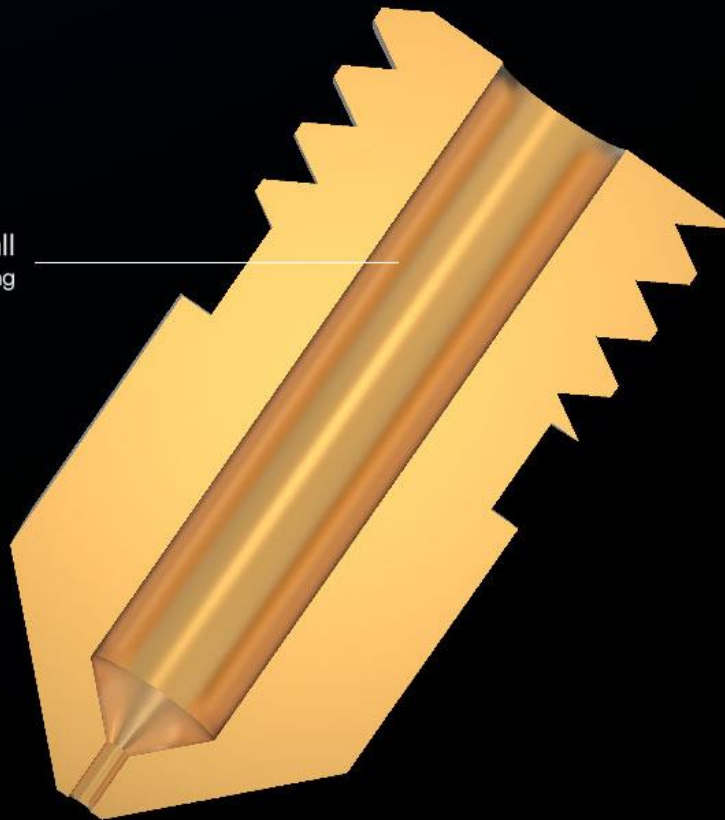

Common nozzle ❌

VS

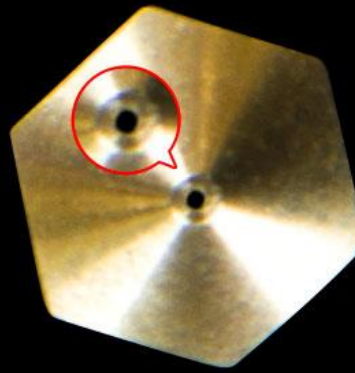

International brass nozzle ✅

Nose with chamfer Round nozzle

Chamfer craft and smooth surface reduce the resistance to filament so that the filament come out smoothly, feed in easier and rarely block the nozzle



Common nozzle ❌

International brass nozzle ✅

Seamless junction



Seamless junction prevents filament leakage from nozzle head



Product Picture

