



# MPQ4418

0.6A, 36V, High-Efficiency, Low  $R_{DS(ON)}$ , Synchronous, Step-Down Converter, AEC-Q100 Qualified

## DESCRIPTION

The MPQ4418 is a high-efficiency, synchronous, rectified, switch-mode, step-down converter with built-in internal power MOSFETs. It can deliver up to 0.6A of continuous output current across a wide input voltage range (4V to 36V), with excellent load and line regulation.

Synchronous mode offers high efficiency across the entire output current load range. Current control mode provides fast transient response and improved loop stabilization.

The MPQ4418's protection features include over-current protection (OCP) and thermal shutdown (TSD).

The MPQ4418 is a compact solution that requires a minimal number of readily available, standard external components, and is available in a small TSOT23-8 package.

## FEATURES

- Wide 4V to 36V Operating Input Range
- Configurable Output from 0.8V
- Internal Low  $R_{DS(ON)}$  90m $\Omega$  High-Side MOSFET (HS-FET) and 55m $\Omega$  Low-Side MOSFET (LS-FET)
- High-Efficiency Synchronous Mode Operation
- 410kHz Default Switching Frequency ( $f_{sw}$ )
- 200kHz to 2.2MHz Synchronized External Clock
- High Duty Cycle for Automotive Cold Crank
- Forced Continuous Conduction Mode (FCCM)
- Internal Soft Start (SS)
- Power Good (PG)
- Over-Current Protection (OCP) with Hiccup Mode
- Thermal Shutdown (TSD)
- Available in a TSOT23-8 Package
- Available in AEC-Q100 Grade 1

## APPLICATIONS

- Automotive
- Industrial Control System
- Distributed Power Systems

All MPS parts are lead-free, halogen-free, and adhere to the RoHS directive. For MPS green status, please visit the MPS website under Quality Assurance. "MPS", the MPS logo, and "Simple, Easy Solutions" are trademarks of Monolithic Power Systems, Inc. or its subsidiaries.

## TYPICAL APPLICATION

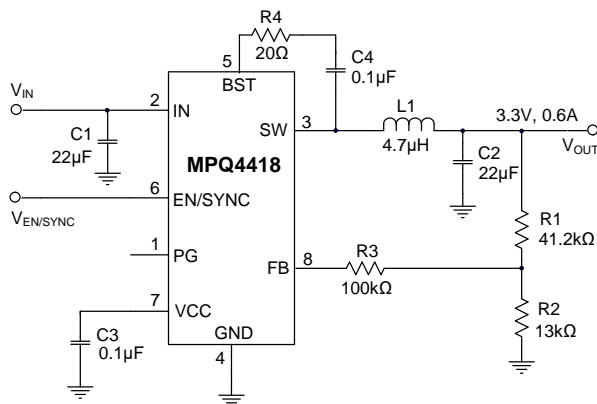

Efficiency vs. Load Current  
 $V_{OUT} = 3.3V$

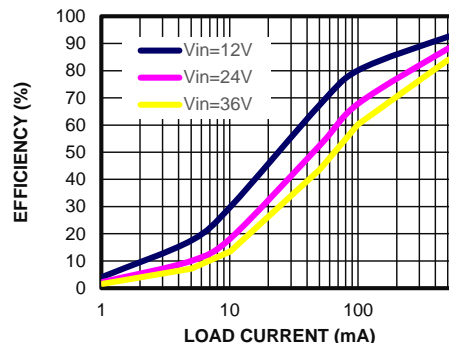

### ORDERING INFORMATION

Part Number*	Package	Top Marking	MSL Rating**
MPQ4418GJ-AEC1	TSOT23-8	See Below	1

\* For Tape & Reel, add suffix -Z (e.g. MPQ4418GJ-AEC1-Z).  
 \*\* Moisture sensitivity level rating.

### TOP MARKING

**| BUGY**

BUG: Product code  
 Y: Year code

### PACKAGE REFERENCE

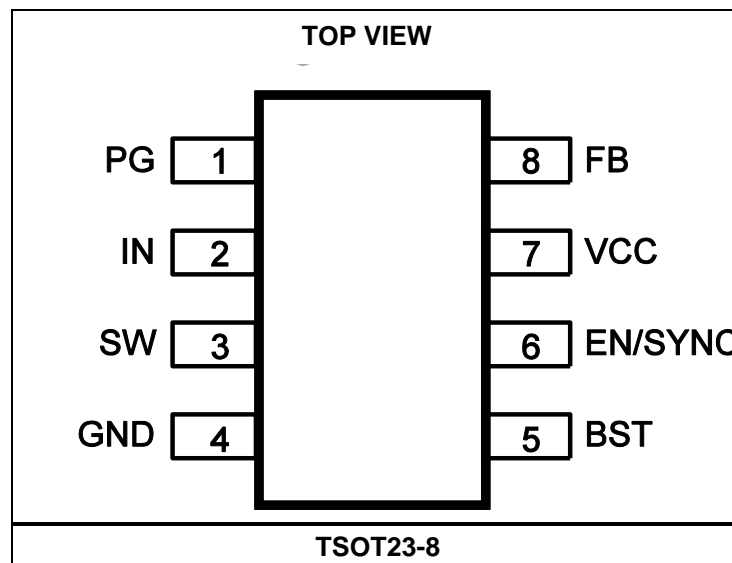

## PIN FUNCTIONS

Pin #	Name	Description
1	PG	<b>Power good.</b> The PG pin is an open-drain output. If the output voltage ( $V_{OUT}$ ) exceeds 90% of the nominal voltage, PG is pulled high.
2	IN	<b>Supply voltage.</b> The MPQ4418 operates from a 4V to 36V input rail. An input capacitor (C1) is required to decouple the input rail. To minimize switching spikes, use an input capacitor (C1) connected to GND to decouple the input rail. Place C1 as close to IN as possible.
3	SW	<b>Switch output.</b> The SW pin is the output of the internal power switch.
4	GND	<b>Reference system ground.</b> The GND pin is critical to PCB layout design. GND is the reference ground of the regulated $V_{OUT}$ . Use copper traces and vias to connect GND to system ground.
5	BST	<b>Bootstrap.</b> Connect a capacitor between the SW and BST pins to form a floating supply across the high-side MOSFET (HS-FET) driver. To reduce SW voltage spikes, it is recommended to place a 20 $\Omega$ resistor between SW and BST.
6	EN/SYNC	<b>Enable/synchronous.</b> To turn on the MPQ4418, drive the EN/SYNC pin high. To configure the switching frequency ( $f_{SW}$ ), apply an external clock to EN/SYNC.
7	VCC	<b>Bias supply.</b> Use a 0.1 $\mu$ F to 0.22 $\mu$ F capacitor to decouple the VCC pin. This capacitor must not exceed 0.22 $\mu$ F.
8	FB	<b>Feedback.</b> To set $V_{OUT}$ , connect the FB pin to the tap of an external resistor divider from the output to GND. If the FB voltage ( $V_{FB}$ ) drops below 660mV, the frequency foldback comparator reduces the oscillator frequency to prevent current limit runaway during a short-circuit fault condition.

### ABSOLUTE MAXIMUM RATINGS <sup>(1)</sup>

$V_{IN}$ .....	-0.3V to +40V
$V_{SW}$ .....	-0.3V to +41V
$V_{BS}$ .....	$V_{SW} + 6V$
All other pins .....	-0.3V to +6V <sup>(2)</sup>
Continuous power dissipation ( $T_A = 25^\circ C$ ) <sup>(3)</sup>	
TSOT23-8 .....	1.25W
Junction temperature .....	150 $^\circ C$
Lead temperature .....	260 $^\circ C$
Storage temperature .....	-65 $^\circ C$ to +150 $^\circ C$

### ESD Ratings

Human body model (HBM) .....	$\pm 2000V$
Charged device model (CDM) .....	$\pm 750V$

### Recommended Operating Conditions

Continuous supply voltage ( $V_{IN}$ ) .....	4V to 36V
Output voltage ( $V_{OUT}$ ) .....	0.8V to 0.9 x $V_{IN}$
Operating junction temp ( $T_J$ ) .....	-40 $^\circ C$ to +125 $^\circ C$

<b>Thermal Resistance <sup>(4)</sup></b>	<b><math>\theta_{JA}</math></b>	<b><math>\theta_{JC}</math></b>
TSOT23-8 .....	100 .....	55... $^\circ C/W$

#### Notes:

- 1) Absolute maximum ratings are rated under room temperature, unless otherwise noted. Exceeding these ratings may damage the device.
- 2) For details on the EN pin's absolute max rating, see the Enable/Synchronous (EN/SYNC) Control section on page 12.
- 3) The maximum allowable power dissipation is a function of the maximum junction temperature  $T_J$  (MAX), the junction-to-ambient thermal resistance  $\theta_{JA}$ , and the ambient temperature  $T_A$ . The maximum allowable continuous power dissipation at any ambient temperature is calculated by  $P_D$  (MAX) =  $(T_J$  (MAX) -  $T_A$ ) /  $\theta_{JA}$ . Exceeding the maximum allowable power dissipation can cause excessive die temperature, and the device may go into thermal shutdown. Internal thermal shutdown circuitry protects the device from permanent damage.
- 4) Measured on JESD51-7, 4-layer PCB.

## ELECTRICAL CHARACTERISTICS

$V_{IN} = 12V$ ,  $T_J = -40^{\circ}C$  to  $+125^{\circ}C$ , typical values are at  $T_J = 25^{\circ}C$ , unless otherwise noted.

Parameter	Symbol	Condition	Min	Typ	Max	Units
Shutdown supply current	$I_{SHDN}$	$V_{EN} = 0V$			8	$\mu A$
Quiescent supply current	$I_Q$	$V_{EN} = 2V$ , $V_{FB} = 1V$ , no switching		0.6	0.8	mA
High-side (HS) on resistance	$R_{ON\_HS}$	$V_{BST\_SW} = 5V$		90	155	m $\Omega$
Low-side (LS) on resistance	$R_{ON\_LS}$	$V_{CC} = 5V$		55	105	m $\Omega$
Switch leakage	$I_{LKG\_SW}$	$V_{EN} = 0V$ , $V_{SW} = 12V$			1	$\mu A$
Current limit	$I_{LIMIT}$	Under 40% duty cycle	3.4	5.6	7.8	A
Oscillator frequency	$f_{SW}$	$V_{FB} = 750mV$	320	410	500	kHz
Foldback frequency	$f_{FB}$	$V_{FB} < 400mV$	70	100	130	kHz
Maximum duty cycle	$D_{MAX}$	$V_{FB} = 750mV$ , 410kHz	92	95		%
Minimum on time <sup>(5)</sup>	$t_{ON\_MIN}$			70		ns
SYNC frequency range	$f_{SYNC}$		0.2		2.4	MHz
Feedback (FB) voltage	$V_{FB}$	$T_J = 25^{\circ}C$	780	792	804	mV
			776		808	
FB current	$I_{FB}$	$V_{FB} = 820mV$		10	100	nA
Enable (EN) rising threshold	$V_{EN\_RISING}$		1.15	1.4	1.65	V
EN falling threshold	$V_{EN\_FALLING}$		1.05	1.25	1.45	V
EN threshold hysteresis	$V_{EN\_HYS}$			150		mV
EN input current	$I_{EN}$	$V_{EN} = 2V$		4	6	$\mu A$
		$V_{EN} = 0V$		0	0.2	$\mu A$
$V_{IN}$ under-voltage lockout (UVLO) rising threshold	$V_{IN\_UVLO\_RISING}$		3.3	3.5	3.7	V
$V_{IN}$ UVLO falling threshold	$V_{IN\_UVLO\_FALLING}$		3.1	3.3	3.5	V
$V_{IN}$ UVLO threshold hysteresis	$V_{IN\_UVLO\_HYS}$			200		mV
VCC regulator	$V_{CC}$	$I_{CC} = 0mA$	4.6	4.9	5.2	V
VCC load regulation		$I_{CC} = 5mA$		1.5	4	%
Soft-start time	$t_{SS}$	$V_{OUT}$ from 10% to 90%	0.55	1.45	2.45	ms
Thermal shutdown (TSD) <sup>(5)</sup>			150	170		$^{\circ}C$
Thermal hysteresis <sup>(5)</sup>				30		$^{\circ}C$
Power good (PG) rising threshold	$PG_{VTH\_RISING}$	As a percentage of $V_{FB}$	86	90	94	%
PG falling threshold	$PG_{VTH\_FALLING}$	As a percentage of $V_{FB}$	80	84	88	%

**ELECTRICAL CHARACTERISTICS (continued)**
 **$V_{IN} = 12V$ ,  $T_J = -40^{\circ}C$  to  $+125^{\circ}C$ , typical values are at  $T_J = 25^{\circ}C$ , unless otherwise noted.**

Parameter	Symbol	Condition	Min	Typ	Max	Units
PG threshold hysteresis	$PG_{VTH\_HYS}$	As a percentage of $V_{FB}$		6		%
PG rising delay	$PG_{TD\_RISING}$		40	90	160	$\mu s$
PG falling delay	$PG_{TD\_FALLING}$		30	55	95	$\mu s$
PG sink current	$V_{PG}$	Sink 4mA		0.1	0.3	V
PG leakage current	$I_{LKG\_PG}$			10	100	nA

**Note:**

5) Guaranteed by design. Not tested in production.

## TYPICAL PERFORMANCE CHARACTERISTICS

$V_{IN} = 12V$ ,  $V_{OUT} = 3.3V$ ,  $L = 10\mu H$ ,  $R_{BST} = 20\Omega$ ,  $T_A = 25^\circ C$ , unless otherwise noted.

### Efficiency vs. Load Current

$V_{OUT} = 3.3V$

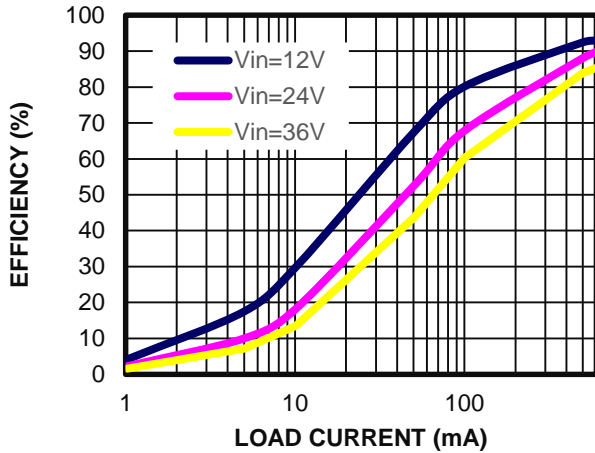

### Efficiency vs. Load Current

$V_{OUT} = 5V$

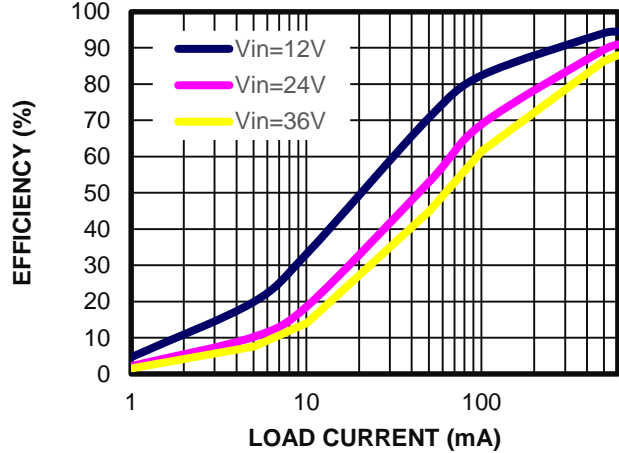

### Case Temperature Rise vs. Load Current

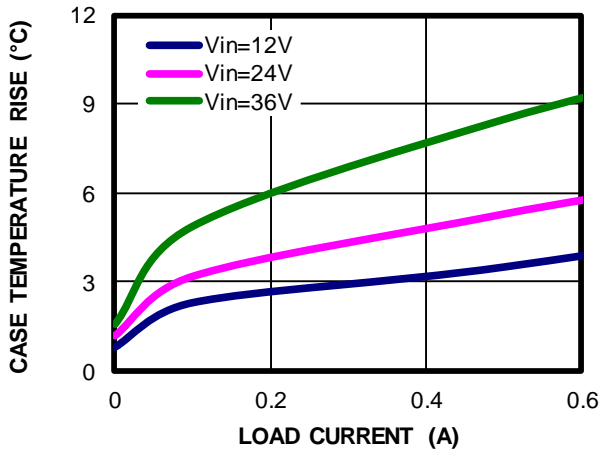

### Line Regulation

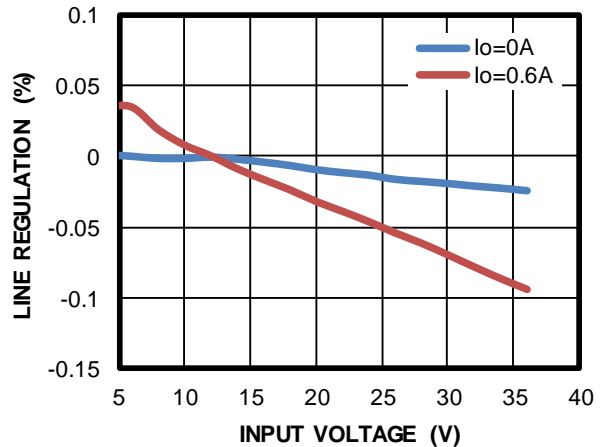

### Load Regulation

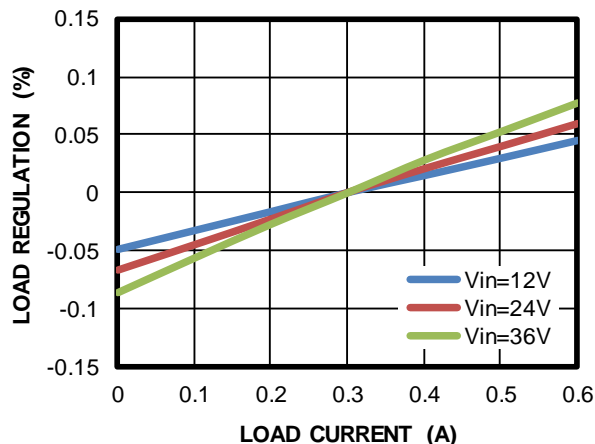

**TYPICAL PERFORMANCE CHARACTERISTICS (continued)**
 $V_{IN} = 12V$ ,  $V_{OUT} = 3.3V$ ,  $L = 10\mu H$ ,  $R_{BST} = 20\Omega$ ,  $T_A = 25^\circ C$ , unless otherwise noted.

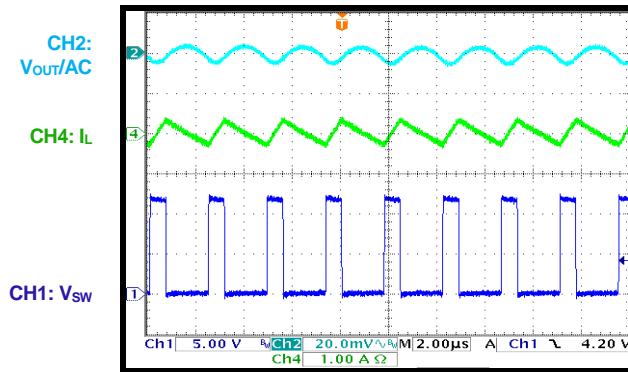
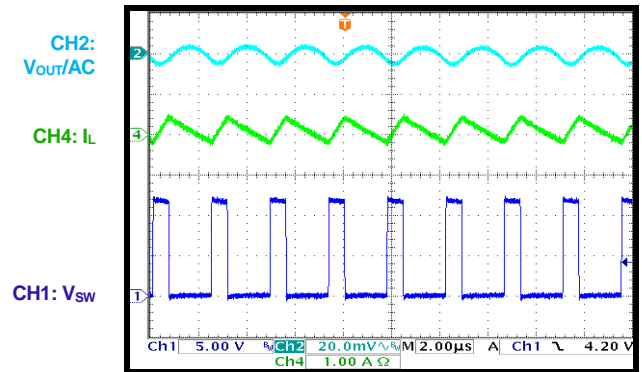
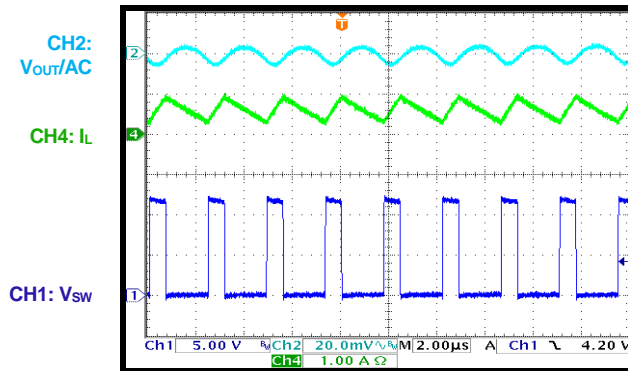
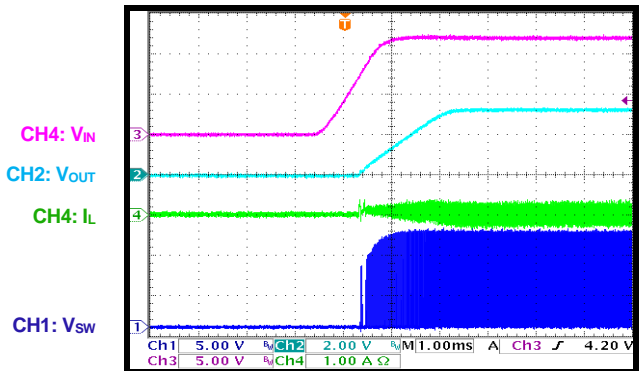
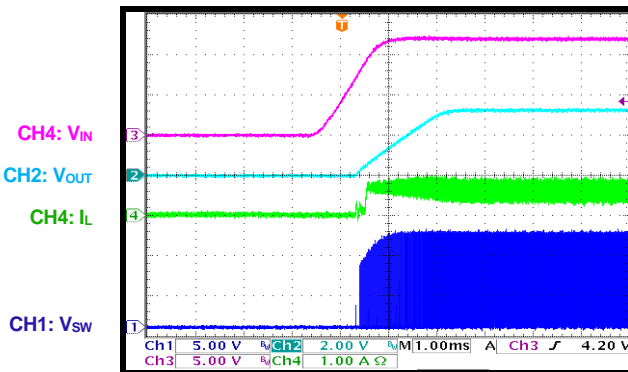
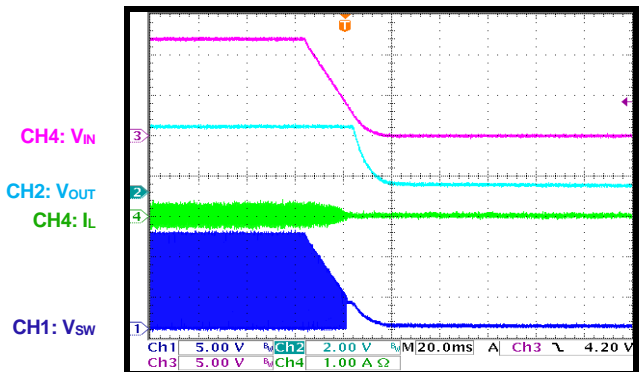
**Steady State**
 $I_{OUT} = 0A$ 

**Steady State**
 $I_{OUT} = 0.1A$ 

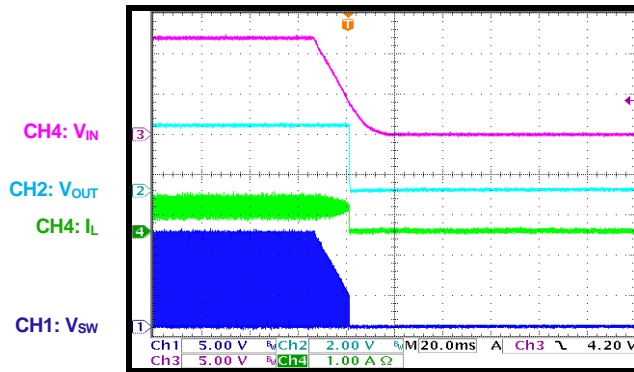
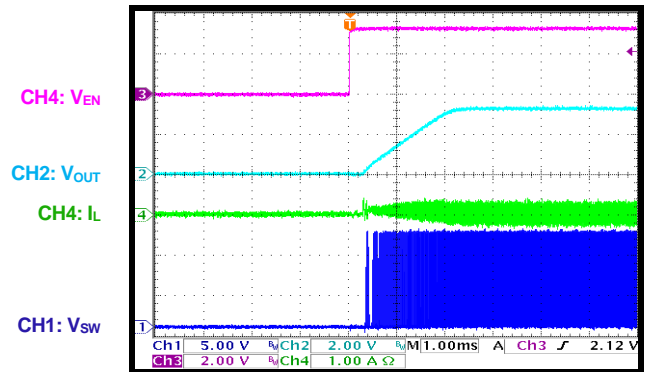
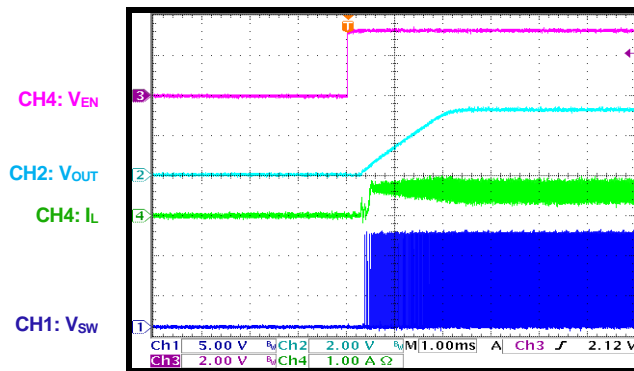
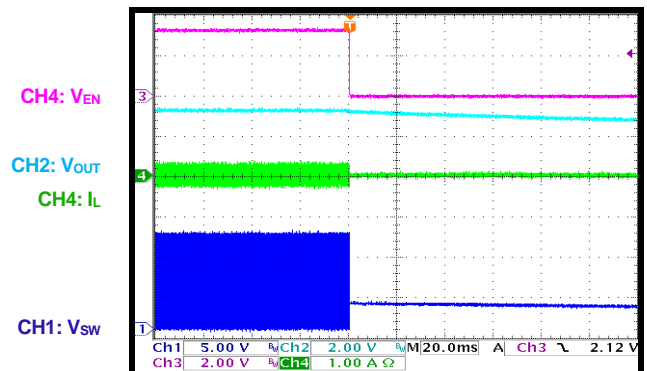
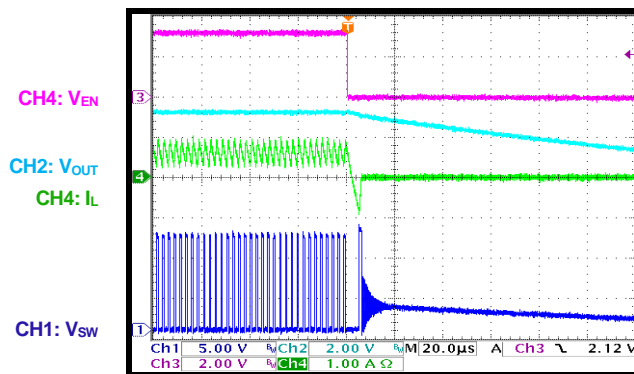
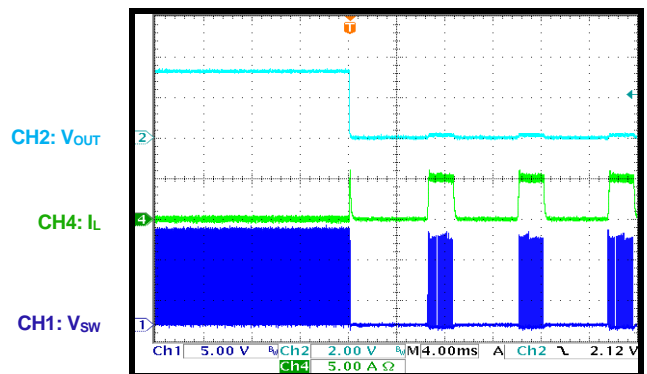
**Steady State**
 $I_{OUT} = 0.6A$ 

**Start-Up through VIN**
 $I_{OUT} = 0A$ 

**Start-Up through VIN**
 $I_{OUT} = 0.6A$ 

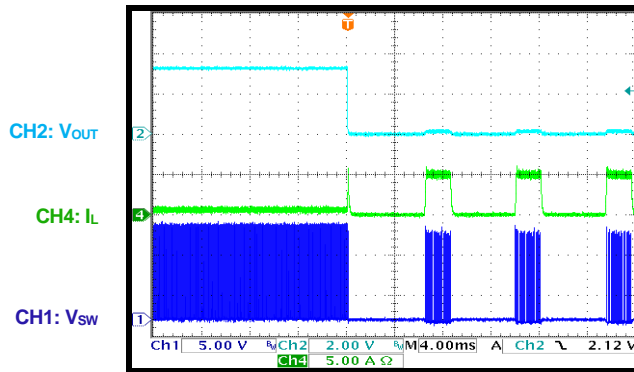
**Shutdown through VIN**
 $I_{OUT} = 0A$ 

**TYPICAL PERFORMANCE CHARACTERISTICS (continued)**
 $V_{IN} = 12V$ ,  $V_{OUT} = 3.3V$ ,  $L = 10\mu H$ ,  $R_{BST} = 20\Omega$ ,  $T_A = 25^\circ C$ , unless otherwise noted.

**Shutdown through VIN**
 $I_{OUT} = 0.6A$ 

**Start-Up through EN**
 $I_{OUT} = 0A$ 

**Start-Up through EN**
 $I_{OUT} = 0.6A$ 

**Shutdown through EN**
 $I_{OUT} = 0A$ 

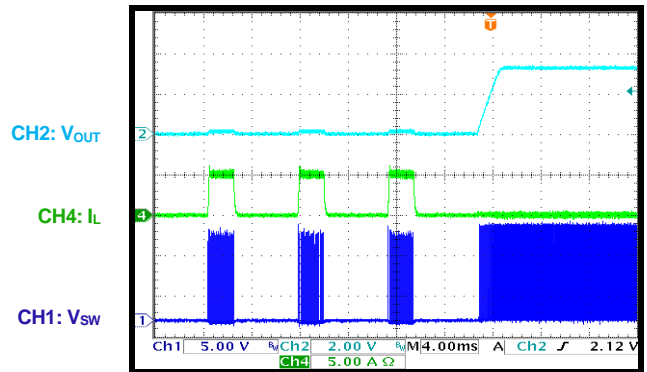
**Shutdown through EN**
 $I_{OUT} = 0.6A$ 

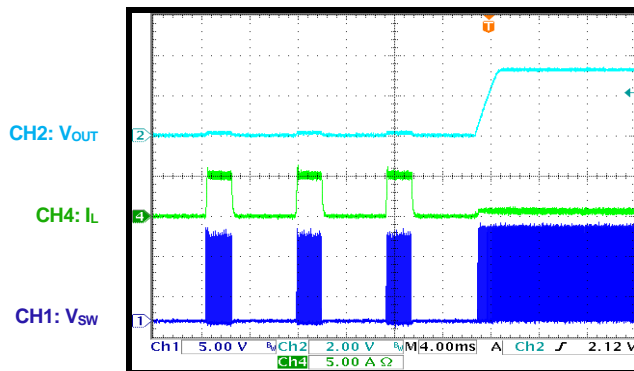
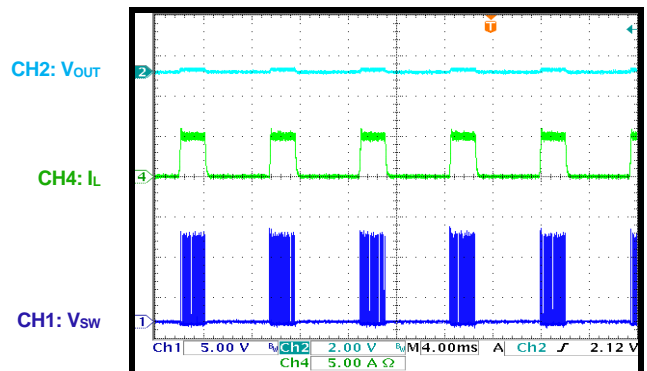
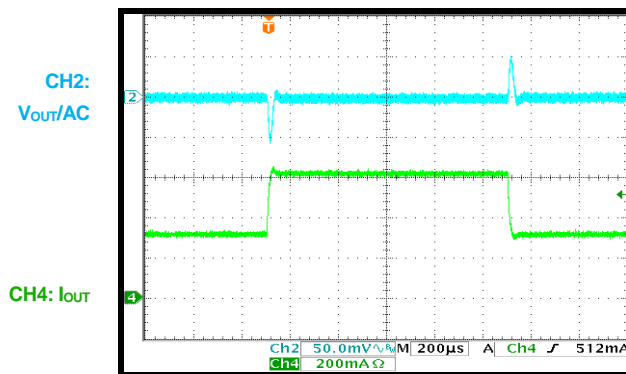
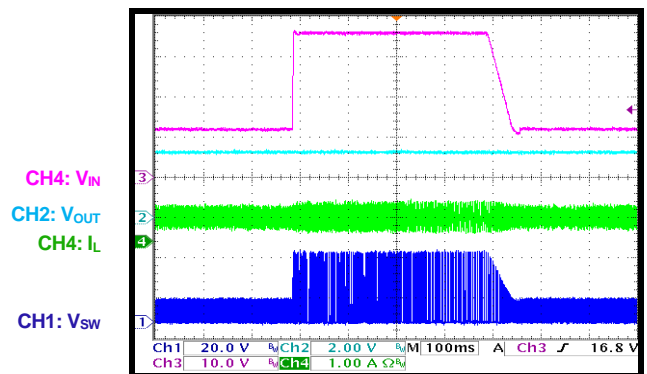
**SCP Entry**
 $I_{OUT} = 0A$  to short circuit



**TYPICAL PERFORMANCE CHARACTERISTICS (continued)**
 $V_{IN} = 12V$ ,  $V_{OUT} = 3.3V$ ,  $L = 10\mu H$ ,  $R_{BST} = 20\Omega$ ,  $T_A = 25^\circ C$ , unless otherwise noted.

**SCP Entry**
 $I_{OUT} = 0.6A$  to short circuit

**SCP Recovery**

 Short circuit to  $I_{OUT} = 0A$ 

**SCP Recovery**

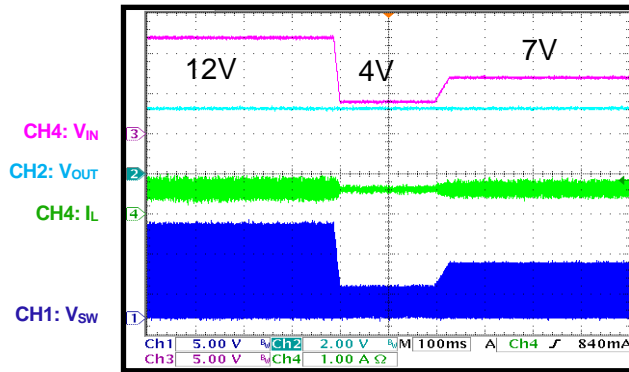
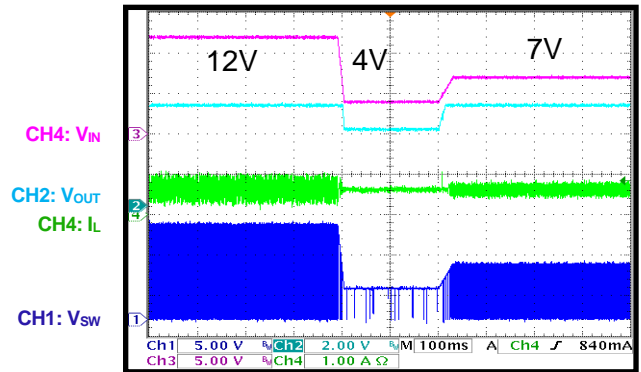
 Short circuit to  $I_{OUT} = 0.6A$ 

**SCP Steady State**

**Load Transient**
 $I_{OUT} = 0.3A$  to  $0.6A$ ,  $1.6A/\mu s$ 

**Load Dump**
 $V_{IN} = 12V$  to  $36V$ ,  $I_{OUT} = 0.6A$ 

**TYPICAL PERFORMANCE CHARACTERISTICS (continued)**
 $V_{IN} = 12V$ ,  $V_{OUT} = 3.3V$ ,  $L = 10\mu H$ ,  $R_{BST} = 20\Omega$ ,  $T_A = 25^\circ C$ , unless otherwise noted.

**Cold Crank**
 $V_{OUT} = 3.3V$ ,  $I_{OUT} = 0.6A$ 

**Cold Crank**
 $V_{OUT} = 5V$ ,  $I_{OUT} = 0.6A$ 

## FUNCTIONAL BLOCK DIAGRAM

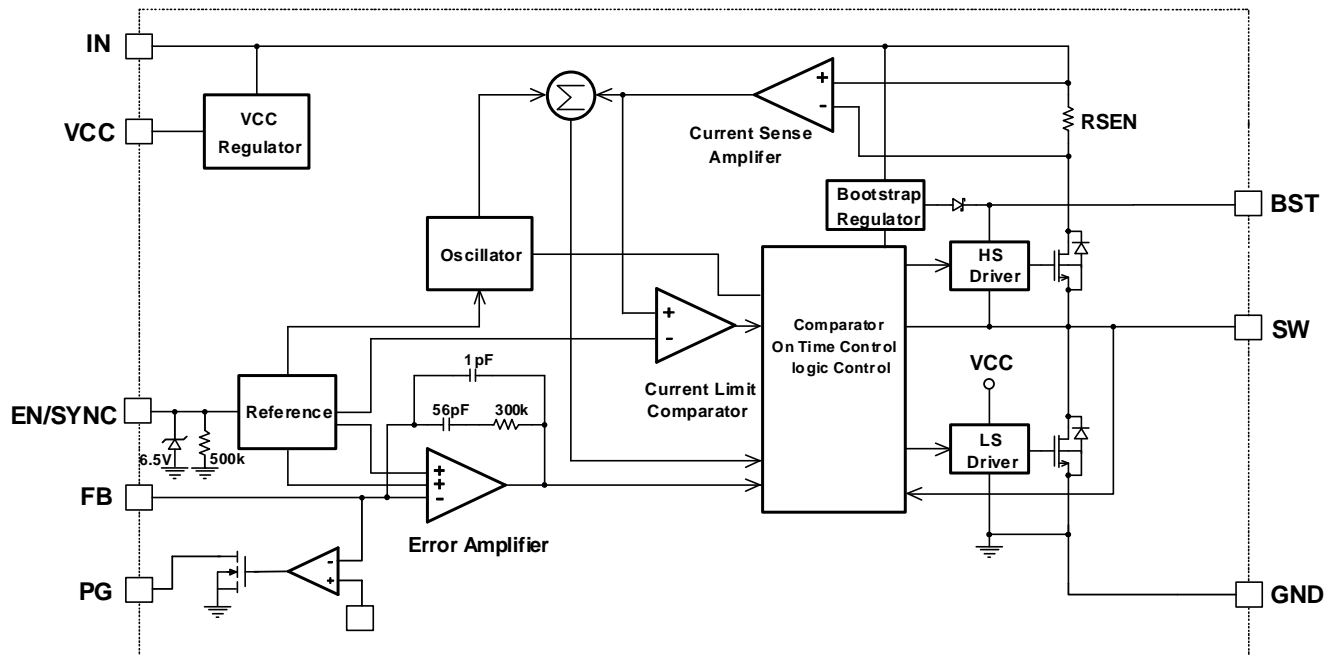

Figure 1: Functional Block Diagram

## OPERATION

The MPQ4418 is a high-efficiency, synchronous, rectified, switch-mode, step-down converter with built-in internal power MOSFETs. It offers a compact solution that achieves up to 0.6A of continuous output current across a wide input supply range, with excellent load and line regulation.

To regulate the output voltage ( $V_{OUT}$ ), the MPQ4418 operates in a fixed-frequency, peak current control mode. An internal clock initiates the pulse-width modulation (PWM) cycle. If the high-side power MOSFET (HS-FET) turns on, it remains on until its current reaches the value set by the COMP voltage ( $V_{COMP}$ ). If the HS-FET turns off, it remains off until the next clock cycle begins. If the current in the HS-FET does not reach the set  $V_{COMP}$  value within 95% of one PWM period, the HS-FET is forced to turn off.

### Internal Regulator

The 5V internal regulator powers most of the internal circuitry. The regulator takes the input voltage ( $V_{IN}$ ) and operates in the full  $V_{IN}$  range. If  $V_{IN}$  exceeds 5V, the regulator output operates in full regulation. If  $V_{IN}$  drops below 5V, the regulator output decreases to match  $V_{IN}$ . Use a 0.1 $\mu$ F ceramic capacitor to decouple VCC.

### Error Amplifier (EA)

The error amplifier (EA) compares the FB voltage ( $V_{FB}$ ) to the 0.8V internal reference voltage ( $V_{REF}$ ), and then outputs a  $V_{COMP}$  that controls the MOSFET current. This optimized internal compensation network minimizes the need for multiple external components and simplifies control loop design.

### Enable/Synchronous (EN/SYNC) Control

EN/SYNC is a digital control pin that turns the regulator on and off. Drive EN/SYNC high to turn the regulator on; drive EN/SYNC low to turn the regulator off. A 500k $\Omega$  internal resistor from EN/SYNC to GND allows EN/SYNC to float. Float EN/SYNC to turn off the device.

EN/SYNC is clamped internally by a 6.5V series Zener diode (see Figure 2). Connect the EN/SYNC input to any  $V_{IN}$  source via a pull-up resistor. The pull-up resistor limits EN/SYNC's input current to 150 $\mu$ A.

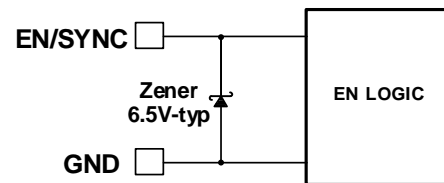

Figure 2: 6.5V Zener Diode

For example, if 12V is connected to  $V_{IN}$ , then  $R_{PULLUP} \geq (12V - 6.5V) / 150\mu A = 36.7k\Omega$ .

To connect EN/SYNC directly to a voltage source without a pull-up resistor, the voltage amplitude must be limited at or below 6V to prevent damage to the Zener diode.

To use the synchronous function, connect a 200kHz to 2.2MHz external clock to EN/SYNC. The external clock must be connected for a minimum of 2ms after  $V_{OUT}$  is set. If the external clock is connected, the internal clock's rising edge is synchronized to the external clock's rising edge. The external clock's pulse width signal must be below 1.7 $\mu$ s.

### Under-Voltage Lockout (UVLO)

Under-voltage lockout (UVLO) protects the device from operating at an insufficient supply voltage. The internal regulator's (VCC's)  $V_{OUT}$  is monitored by the UVLO comparator. The UVLO rising threshold is about 3.5V, and its falling threshold is 3.3V.

### Internal Soft Start (SS)

Soft start (SS) prevents the converter's  $V_{OUT}$  from overshooting during start-up. When the device starts up, the internal circuitry generates a soft-start voltage ( $V_{SS}$ ) that ramps up from 0V to 1.2V. If  $V_{SS}$  drops below  $V_{REF}$ ,  $V_{SS}$  overrides  $V_{REF}$ . The EA then uses  $V_{SS}$  as its reference. When  $V_{SS}$  exceeds  $V_{REF}$ , the EA uses  $V_{REF}$  as its reference. The soft-start time ( $t_{SS}$ ) is internally set to 1.5ms.

### Over-Current Protection (OCP) with Hiccup Mode

The MPQ4418 uses cycle-by-cycle over-current protection (OCP) when the inductor's peak current exceeds the current limit threshold. If  $V_{FB}$  drops below the UVLO threshold (typically 84% below  $V_{REF}$ ), the MPQ4418 enters hiccup mode and periodically restarts the part. OCP is critical when the output is dead-shortened to GND.

Reducing the average short-circuit current both protects the regulator and reduces thermal issues. Once the over-current condition is removed, the MPQ4418 exits hiccup mode and resumes normal operation.

### Thermal Shutdown (TSD)

Thermal shutdown (TSD) prevents the device from operating at exceedingly high temperatures. If the silicon die temperature exceeds 170°C, the MPQ4418 shuts down. If the temperature drops below the low threshold (typically 140°C), the chip starts up again and resumes normal operation.

### Floating Driver and Bootstrap (BST) Charging

An external bootstrap (BST) capacitor ( $C_{BST}$ ) powers the floating MOSFET driver. A dedicated internal regulator charges and regulates the  $C_{BST}$  voltage at 5V.

If the voltage between the BST and SW nodes drops below the regulation voltage, a P-channel MOSFET pass transistor connected from the VIN pin to the BST pin turns on. The charging current path is from VIN to BST to SW. The external circuit should provide enough voltage headroom to facilitate charging. As long as  $V_{IN}$  significantly exceeds  $V_{SW}$ ,  $C_{BST}$  should remain charged. If the HS-FET is on,  $V_{IN}$  should be about equal to  $V_{SW}$ . In this scenario,  $C_{BST}$  does not charge. If the LS-FET is on,  $(V_{IN} - V_{SW})$  should reach its fast charging maximum (see Figure 3). When the HS-FET and LS-FET are both off,  $V_{SW}$  should be equal to  $V_{OUT}$ , and the difference between  $V_{IN}$  and  $V_{OUT}$  should charge  $C_{BST}$  (see Figure 4).

The floating driver has its own UVLO protection: a 2.2V rising threshold and 150mV hysteresis. It is recommended to place a 20Ω resistor between the SW pin and  $C_{BST}$  to reduce SW voltage spikes.

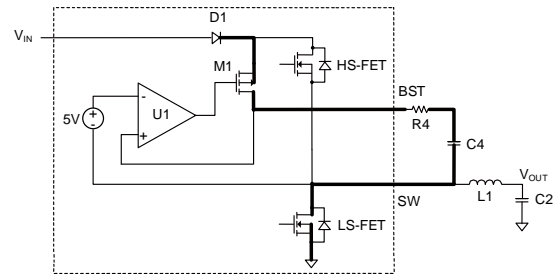

**Figure 3: BST Charging Path (LS-FET On)**

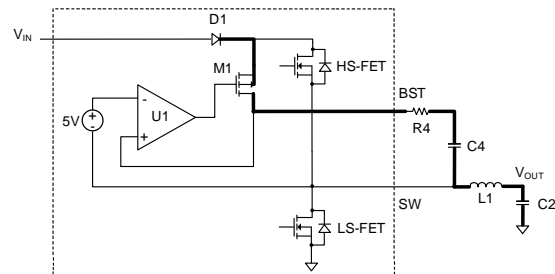

**Figure 4: BST Charging Path (HS-FET and LS-FET Off)**

### Start-Up and Shutdown

If both  $V_{IN}$  and EN/SYNC exceed their respective thresholds, the MPQ4418 starts up. The reference block turns on first, and generates a stable  $V_{REF}$  and current. Then the internal regulator turns on and provides a stable supply for the remaining circuitries.

Three events can shut down the MPQ4418: EN/SYNC being pulled low,  $V_{IN}$  being pulled low, and TSD. During the shutdown procedure, the signaling path is blocked to avoid any fault triggering; then  $V_{COMP}$  and the internal supply rail are pulled down. The floating driver is not subject to this shutdown command.

### Power Good (PG)

The MPQ4418 has a power good (PG) open-drain output. PG should be connected to VCC or another voltage source through a resistor (e.g. 100kΩ). In the presence of  $V_{IN}$ , the MOSFET turns on and PG is pulled low before SS is ready. If  $V_{FB}$  reaches 90% of  $V_{REF}$ , PG is pulled high after about a 90μs delay. If  $V_{FB}$  drops to 84% of  $V_{REF}$ , PG is pulled low. If TSD occurs or if EN/SYNC is pulled low, PG is also pulled low.

## APPLICATION INFORMATION

### Setting the Output Voltage ( $V_{OUT}$ )

The external resistor divider sets  $V_{OUT}$  (see the Typical Application Circuit section on page 17). The feedback (FB) resistor ( $R1$ ) also sets the FB loop bandwidth via the internal compensation capacitor. Choose  $R1$  to be about 40k $\Omega$ . Then  $R2$  can be calculated with Equation (1):

$$R2 = \frac{R1}{\frac{V_{OUT}}{0.792V} - 1} \quad (1)$$

If  $V_{OUT}$  is low, it is recommended to use a T-type network (see Figure 5).

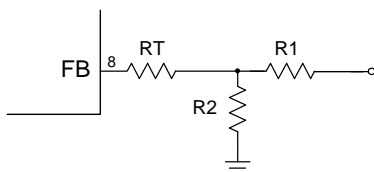

**Figure 5: T-Type Network**

Add  $R_T$  to  $R1$  to set the loop bandwidth. The higher the value of  $R_T + R1$ , the lower the loop bandwidth. To ensure loop stability, limit the loop bandwidth at 40kHz (based on the 410kHz default  $f_{SW}$ ). Table 1 lists the recommended T-type resistor values for common  $V_{OUT}$  values.

**Table 1: Resistor Selection**

$V_{OUT}$ (V)	$R1$ (k $\Omega$ )	$R2$ (k $\Omega$ )	$R_T$ (k $\Omega$ )
3.3	41.2 (1%)	13 (1%)	100 (1%)
5	41.2 (1%)	7.68 (1%)	100 (1%)

### Selecting the Inductor

Use a 1 $\mu$ H to 10 $\mu$ H inductor with a DC current rating that exceeds the maximum load current by at least 25%. For highest efficiency, use an inductor with a small DC resistance. For most designs, the inductance ( $L_1$ ) can be calculated with Equation (2):

$$L_1 = \frac{V_{OUT} \times (V_{IN} - V_{OUT})}{V_{IN} \times \Delta I_L \times f_{OSC}} \quad (2)$$

Where  $\Delta I_L$  is the inductor ripple current.

Choose the inductor ripple current to be about 30% of the maximum load current. The maximum inductor peak current ( $I_{L(MAX)}$ ) can be calculated with Equation (3):

$$I_{L(MAX)} = I_{LOAD} + \frac{\Delta I_L}{2} \quad (3)$$

Use a larger inductor for improved efficiency under light-load conditions (below 100mA).

### Input Voltage ( $V_{IN}$ ) UVLO Setting

The MPQ4418 has an internal, fixed UVLO threshold. The UVLO rising threshold is 3.5V, and its falling threshold is about 3.3V. For applications that require a higher UVLO point, an external resistor divider can be used between EN/SYNC and IN to achieve a higher equivalent UVLO threshold (see Figure 6).

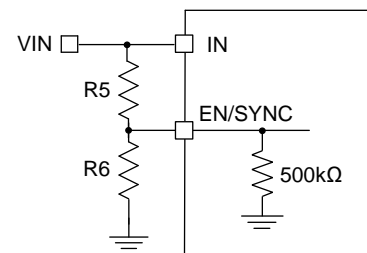

**Figure 6: Configurable UVLO with EN/SYNC Divider**

The UVLO rising threshold can be calculated with Equation (4):

$$V_{IN\_UVLO\_RISING} = \left(1 + \frac{R5}{500k\Omega/R6}\right) \times V_{EN\_RISING} \quad (4)$$

Where  $V_{EN\_RISING}$  is 1.4V.

The UVLO falling threshold can be calculated with Equation (5):

$$V_{IN\_UVLO\_FALLING} = \left(1 + \frac{R5}{500k\Omega/R6}\right) \times V_{EN\_FALLING} \quad (5)$$

Where  $V_{EN\_FALLING}$  is 1.25V.

When selecting  $R5$ , ensure that it is large enough to limit the current flowing into EN/SYNC below 150 $\mu$ A.

### Selecting the Input Capacitor

The step-down converter has a discontinuous input current that requires a capacitor to supply AC current to the converter, while also maintaining the DC input voltage. It is recommended to use ceramic capacitors with X5R or X7R dielectrics for their low ESR and

small temperature coefficients. For most applications, a 22μF ceramic capacitor is sufficient to maintain the DC input voltage. Use another, lower-value capacitor (e.g. 0.1μF) with a small package size (0603) to absorb high-frequency switching noise. Place the smaller capacitor as close to IN and GND as possible (see the PCB Layout Guidelines section on page 16).

Since the input capacitor (C1) absorbs the input switching current, it requires an adequate ripple current rating. The RMS current in C1 ( $I_{C1}$ ) can be estimated with Equation (6):

$$I_{C1} = I_{LOAD} \times \sqrt{\frac{V_{OUT}}{V_{IN}} \times \left(1 - \frac{V_{OUT}}{V_{IN}}\right)} \quad (6)$$

The worst-case scenario occurs at  $V_{IN} = 2 \times V_{OUT}$ , which can be estimated with Equation (7):

$$I_{C1} = \frac{I_{LOAD}}{2} \quad (7)$$

Choose a capacitor with an RMS current rating greater than half of the maximum load current.

C1 can be electrolytic, tantalum, or ceramic. When using electrolytic or tantalum capacitors, place a small, high-quality ceramic capacitor (e.g. 1μF) as close to the IC as possible. Ensure that the ceramic capacitors have enough capacitance and provide sufficient charge to prevent excessive input voltage ripple. The input voltage ripple caused by the capacitance can be estimated with Equation (8):

$$\Delta V_{IN} = \frac{I_{LOAD}}{f_{SW} \times C1} \times \frac{V_{OUT}}{V_{IN}} \times \left(1 - \frac{V_{OUT}}{V_{IN}}\right) \quad (8)$$

### Selecting the Output Capacitor

The output capacitor (C2) maintains the DC output voltage. It is recommended to use ceramic, tantalum, or low-ESR electrolytic capacitors. For the best results, use low-ESR capacitors to prevent excessive output voltage ripple. The output voltage ripple can be estimated with Equation (9):

$$\Delta V_{OUT} = \frac{V_{OUT}}{f_{SW} \times L_1} \times \left(1 - \frac{V_{OUT}}{V_{IN}}\right) \times \left(R_{ESR} + \frac{1}{8 \times f_{SW} \times C2}\right) \quad (9)$$

Where  $L_1$  is the inductor value, and  $R_{ESR}$  is the C2 equivalent series resistance (ESR) value.

For ceramic capacitors, the capacitance dominates the impedance at the switching frequency ( $f_{SW}$ ) and causes the majority of the output voltage ripple. For simplification, the output voltage ripple can be estimated with Equation (10):

$$\Delta V_{OUT} = \frac{V_{OUT}}{8 \times f_{SW}^2 \times L_1 \times C2} \times \left(1 - \frac{V_{OUT}}{V_{IN}}\right) \quad (10)$$

(10)

When using tantalum or electrolytic capacitors, the ESR dominates the impedance at  $f_{SW}$ . For simplification, the output ripple can be estimated with Equation (11):

$$\Delta V_{OUT} = \frac{V_{OUT}}{f_{SW} \times L_1} \times \left(1 - \frac{V_{OUT}}{V_{IN}}\right) \times R_{ESR} \quad (11)$$

(11)

The characteristics of C2 also affect the stability of the regulation system. The MPQ4418 can be optimized for a wide range of capacitances and ESR values.

### BST Resistor and External BST Diode

It is recommended to use a 20Ω resistor in series with a BST capacitor ( $C_{BST}$ ) to reduce SW voltage spikes. Using a higher resistance helps reduce SW voltage spikes, but can compromise efficiency.

An external BST diode can enhance the efficiency of the regulator when the duty cycle is high (above 65%). Use a 2.5V to 5V power supply to power the external BST diode. Either  $V_{CC}$  or  $V_{OUT}$  can be used as the power supply in the circuit (see Figure 7).

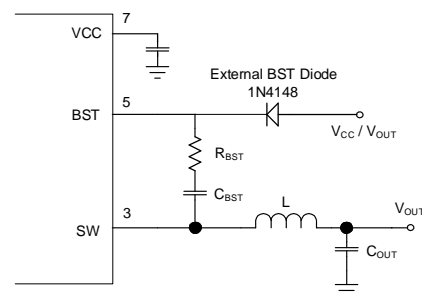

**Figure 7: Optional External BST Diode for Enhanced Efficiency**

It is recommended to use an IN4148 external BST diode. The recommended  $C_{BST}$  value is 0.1μF to 1μF.

### PCB Layout Guidelines

Efficient PCB layout is critical for stable operation. For the best results, refer to Figure 8 and follow the guidelines below:

1. Place C1 as close to IN and GND as possible. Make the connection between C1 and IN as short and wide as possible.
2. Place the VCC capacitor as close to VCC and GND as possible. Make the trace length of VCC to the VCC capacitor to GND as short as possible.
3. Use a large ground plane to connect directly to GND.
4. If the ground plane is the bottom layer, place vias around GND.
5. Route SW and BST away from sensitive analog areas, such as FB.
6. Place the T-type FB resistor close to the chip to ensure that the trace connecting to FB is as short as possible.

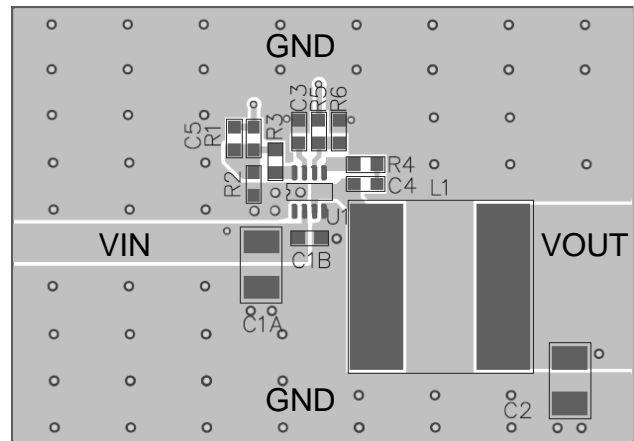

**Top Layer**

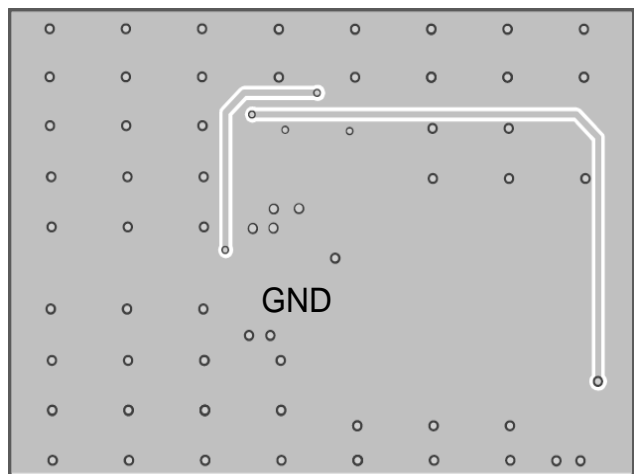

**Bottom Layer**

**Figure 8: Recommended PCB Layout**

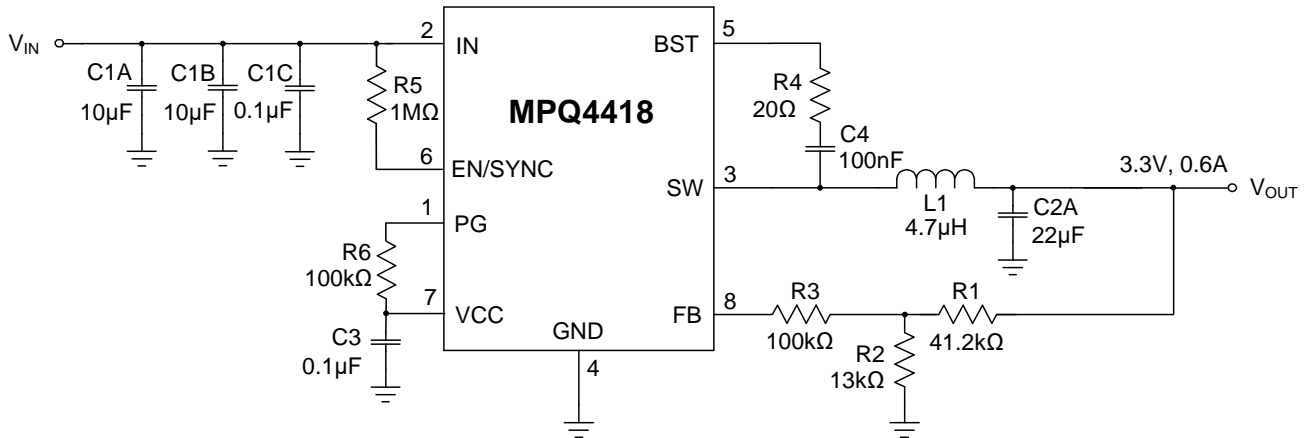

**TYPICAL APPLICATION CIRCUIT**

**Figure 8: Typical Application Circuit (3.3V Output)**

# PACKAGE INFORMATION

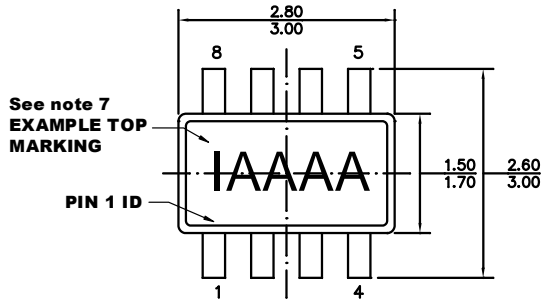
## TSOT23-8

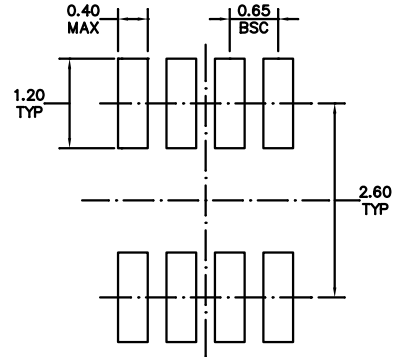

**TOP VIEW**



**RECOMMENDED LAND PATTERN**

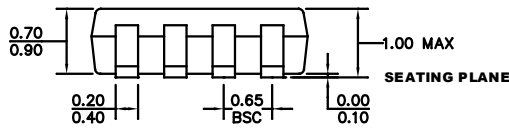

**FRONT VIEW**

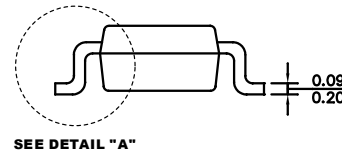

**SIDE VIEW**

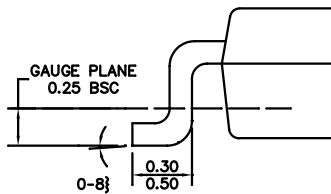

**DETAIL "A"**

### NOTE:

- 1) ALL DIMENSIONS ARE IN MILLIMETERS.
- 2) PACKAGE LENGTH DOES NOT INCLUDE MOLD FLASH, PROTRUSION, OR GATE BURR.
- 3) PACKAGE WIDTH DOES NOT INCLUDE INTERLEAD FLASH OR PROTRUSION.
- 4) LEAD COPLANARITY (BOTTOM OF LEADS AFTER FORMING) SHALL BE 0.1 MILLIMETERS MAXIMUM.
- 5) JEDEC REFERENCE IS MO-193, VARIATION BA.
- 6) DRAWING IS NOT TO SCALE.
- 7) WHEN READING THE TOP MARKING FROM LEFT TO RIGHT, PIN 1 IS THE LOWER LEFT PIN (SEE EXAMPLE TOP MARKING).

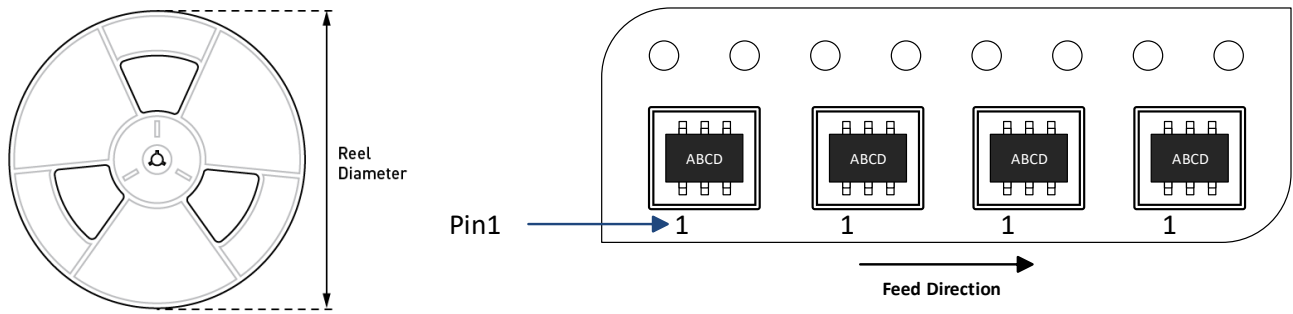
**CARRIER INFORMATION**

Part Number	Package Description	Quantity/ Reel	Quantity/ Tube	Quantity/ Tray	Reel Diameter	Carrier Tape Width	Carrier Tape Pitch
MPQ4418GJ-AEC1-Z	TSOT23-8	3000	N/A	N/A	7in	8mm	4mm

## REVISION HISTORY

Revision #	Revision Date	Description	Pages Updated
1.0	3/16/2021	Initial Release	-

**Notice:** The information in this document is subject to change without notice. Please contact MPS for current specifications. Users should warrant and guarantee that third-party Intellectual Property rights are not infringed upon when integrating MPS products into any application. MPS will not assume any legal responsibility for any said applications.