

Valve terminal CPV-SC, Smart Cubic

FESTO

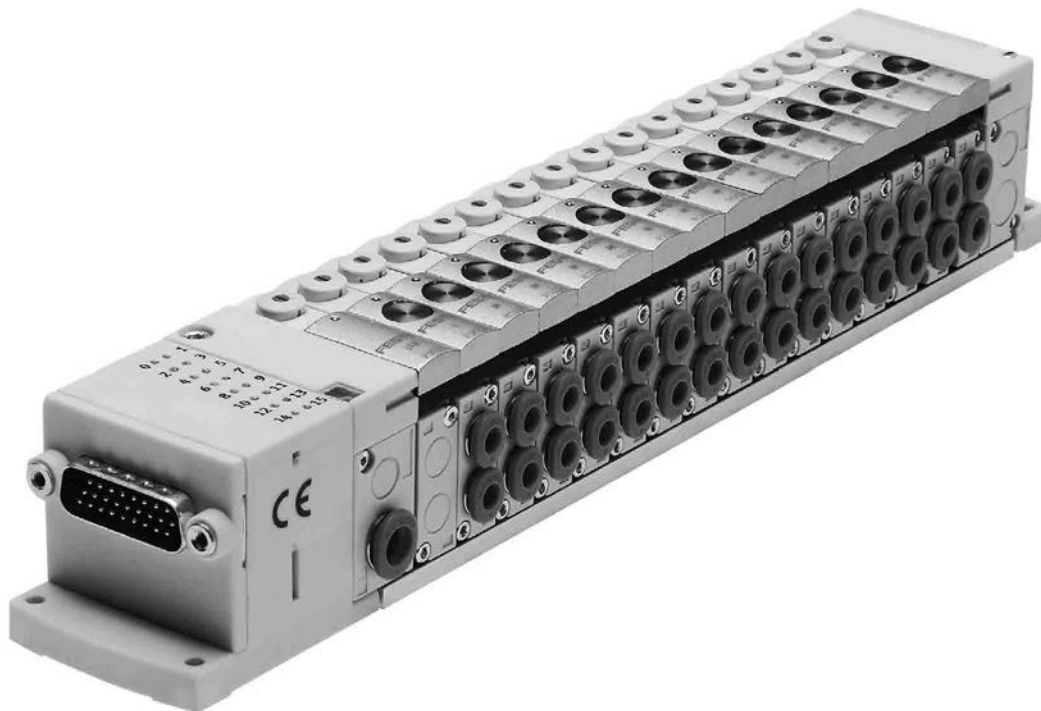

Key features



Innovative

- Small, compact valve terminal for a wide range of pneumatic applications
- Great flexibility during planning, assembly and operation
- Multi-pin interface
- Wide range of selectable valve functions; 5/2-way, 3/2-way and 2/2-way functions
- With a flow rate of 170 l/min, CPV-SC offers outstanding pneumatic performance for a wide range of applications
- Light weight

Versatile

- Provides 2 ... 16 valve positions on one terminal
- Particularly suitable for operation of small pneumatic drives in restricted installation space
- Flexibility of the pneumatic working ports provides a practical solution to different requirements
- Round silencers, integrated flat plate silencers or threaded/push-in connection for ducted exhaust air
- Suitable for vacuum
- Enables multiple pressure zones on a single valve terminal

Reliable

- Manual override
- Durable thanks to tried-and-tested piston spool valves
- Sturdy thanks to metal housing and connecting thread
- Fast troubleshooting thanks to an LED on each valve and diagnostics via fieldbus

Easy to mount

- Fully assembled and tested valve terminal
- Reduced ordering, assembly and commissioning costs
- Suitable for direct mounting even on moving system components

Key features

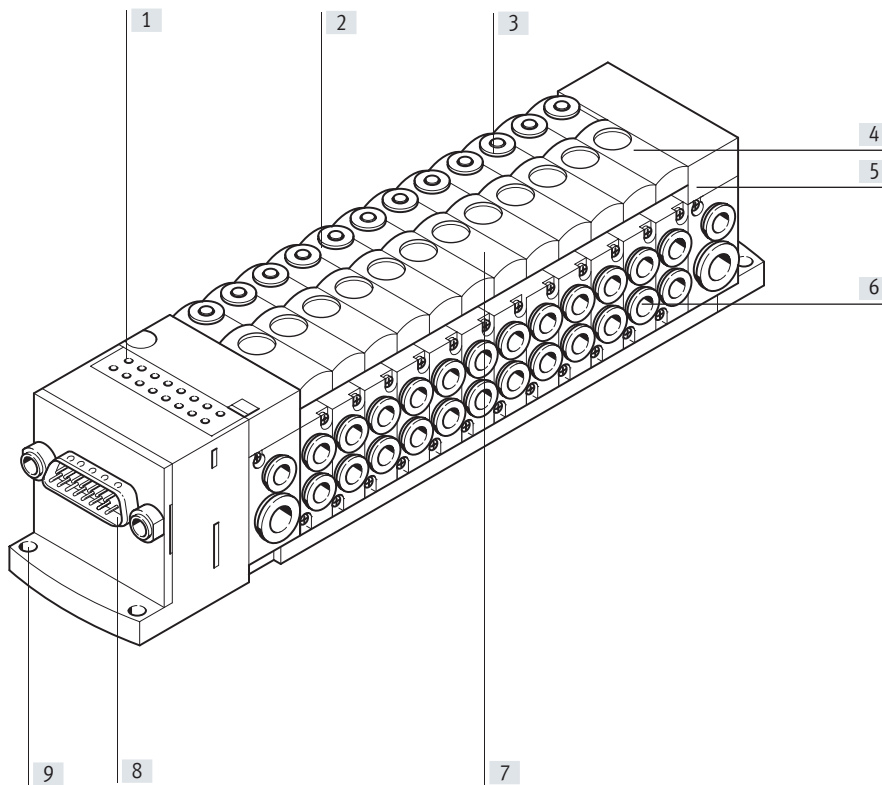

- [1] Reduced downtimes: light emitting diodes indicate the switching status
- [2] Valve size 10 mm
- [3] Reliable operation: manual override non-detenting and detenting
- [4] Simple to extend: blanking plates reserve space for additional valves
- [5] Space saving: Grid 40x40 mm
Maximum 16 valves
- [6] Practical connection: thread or push-in connector
- [7] Comprehensive range of valve functions
- [8] Simple electrical connections: individual valve connection, Sub-D plug, ribbon cable
- [9] Quick to mount: secure directly using screws

Equipment options

Valve functions

- | | |
|--|--|
| <ul style="list-style-type: none"> • 5/2-way valve, single solenoid • 5/2-way valve, double solenoid • 3/2-way valve, normally open | <ul style="list-style-type: none"> • 3/2-way valve, normally closed • 2/2-way valve, normally closed |
|--|--|

Separator plate with additional compressed air supply

- Compressed air duct (1) closed
- Compressed air duct (1) and exhaust duct (3/5) closed

Blanking plate

- Plate without valve function for reserving a valve position

Electrical connection options

Individual connection

- 2 ... 16 valve positions/
max. 16 solenoid coils
- Individual connection, horizontal (H)
- Individual connection, vertical (T)

Multi-pin

- 4 ... 16 valve positions/
max. 16 solenoid coils
- Sub-D
- Ribbon cable

CP interface

- 4 ... 16 valve positions/
max. 16 solenoid coils
- Additional valve terminals CPV-SC-CPI or from CPV series

Key features

Ordering data – Product options

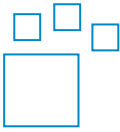

Configurable product
This product and all its product options can be ordered using the configurator.

The configurator can be found under Products on the DVD or at
→ www.festo.com/catalogue/...

Part no.	Type
525675	CPV-SC-MP-VI
538510	CPV-SC-FB-VI

Individual connection

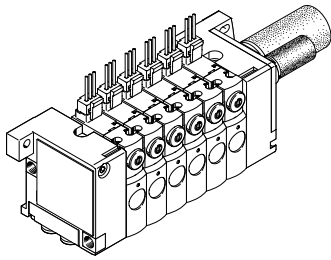

The connection is independent of the control technology and flexible using pre-assembled cables. This ensures that the connection is reverse polarity protected.

Valves with integrated LED (CPVSC1-M1LH- ...) are optionally available for switching status indication.
2 to 16 solenoid coils (divided between 2 to 16 valve positions) can be selected with individual connection.

Versions

- Individual connection, horizontal
- Individual connection, vertical
- 2 to 16 solenoid coils

Multi-pin plug connection

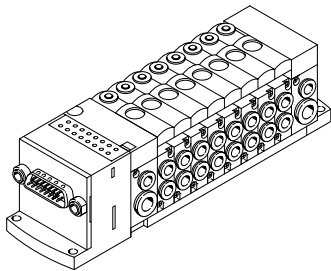

Control signals to the valve terminal are transmitted via a pre-assembled multi-core cable, which substantially reduces installation time.

4 to 16 solenoid coils (divided between 4 to 16 valve positions) can be selected with multi-pin plug connection.

Versions

- Sub-D connection
- Ribbon cable connection
- 4 to 16 solenoid coils

Installation system CPI

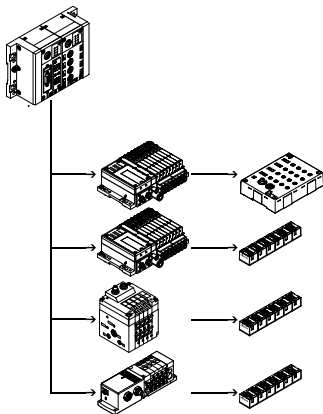

Valve terminal for installation system CPI:
The valve terminal with CP connection is provided for connection to a higher-level bus node or to control blocks. A bus node or control block additionally enables connection of decentralised input/output units.

The following bus protocols are supported:

- PROFIBUS DP
- INTERBUS
- DeviceNet
- CANopen
- CC-Link
- EtherNet/IP
- PROFINET
- POWERLINK
- EtherCAT
- Sercos III

Four strings having up to 32 inputs and outputs can be connected to a bus node or control block. The connecting cables transmit the power supply for the input modules and the load voltage for the valves as well as control signals.

Additional information
→ Internet: ctec

Peripherals overview

Overview – CPV-SC valve terminal

Valve terminal with individual electrical connections

- Vertical individual connection
Code: T
 - Horizontal individual connection
Code: H
- Valve terminals with individual electrical connection can be equipped with 2 to max. 16 valve positions.
- Each valve position can either be equipped with a valve or a blanking plate.

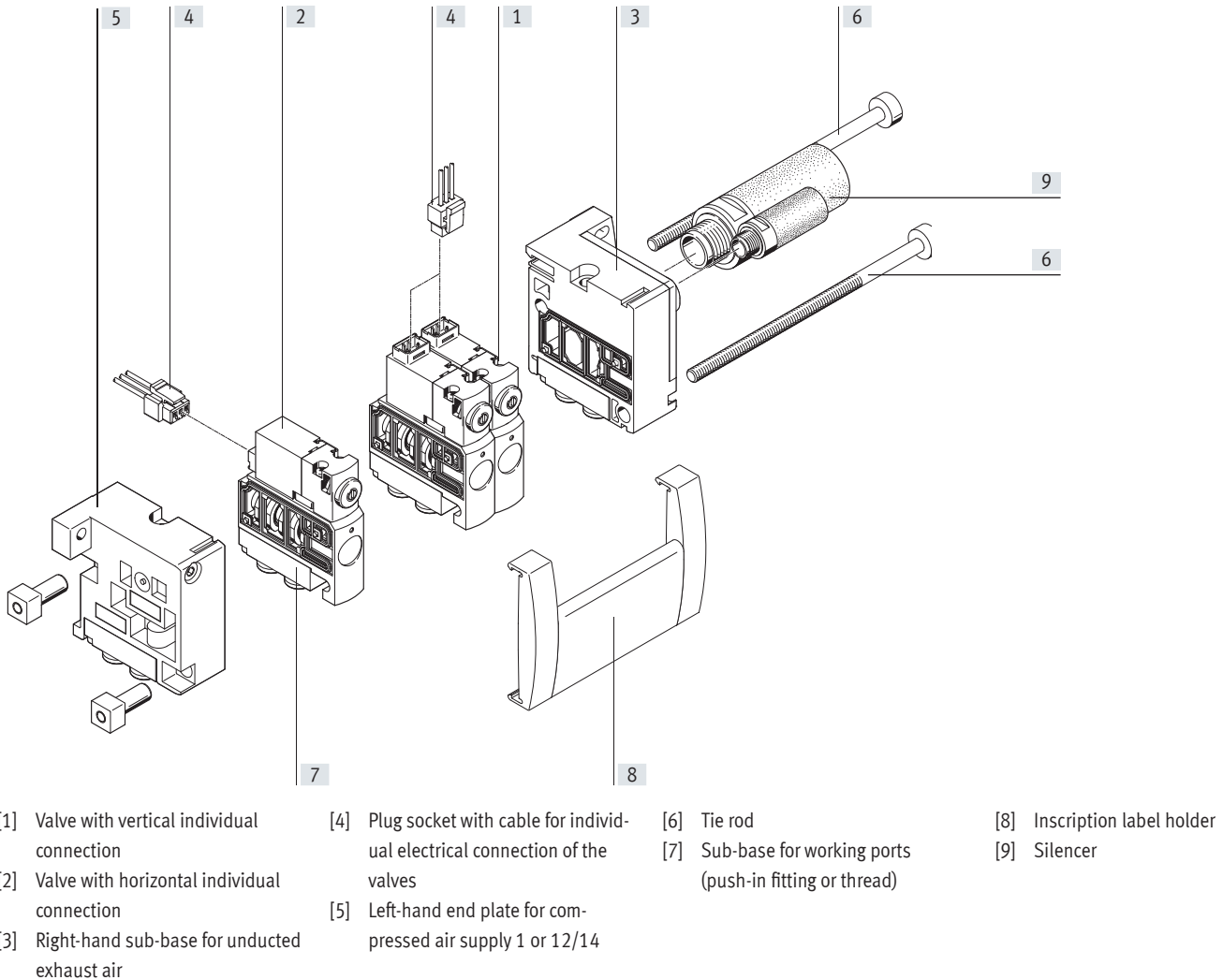

- [1] Valve with vertical individual connection
- [2] Valve with horizontal individual connection
- [3] Right-hand sub-base for unducted exhaust air

- [4] Plug socket with cable for individual electrical connection of the valves
- [5] Left-hand end plate for compressed air supply 1 or 12/14

- [6] Tie rod
- [7] Sub-base for working ports (push-in fitting or thread)

- [8] Inscription label holder
- [9] Silencer

Peripherals overview

Valve terminal with electrical multi-pin plug connection

- 15-pin and 26-pin Sub-D multi-pin plug connection
 - Code: MS, MH
- or
- 20-pin multi-pin plug connection with connector for ribbon cable
 - Code: MF

Valves and end plates are the basic pneumatic components of the valve terminal.
The valve terminals are connected to the end plates using tie rods.

Valve terminals with electrical multi-pin plug connection can be equipped with 4 to max. 16 valve positions. Each valve position can either be equipped with a valve or a blanking plate.

The electrical connection is located on the left-hand side, enabling a particularly flat installation.

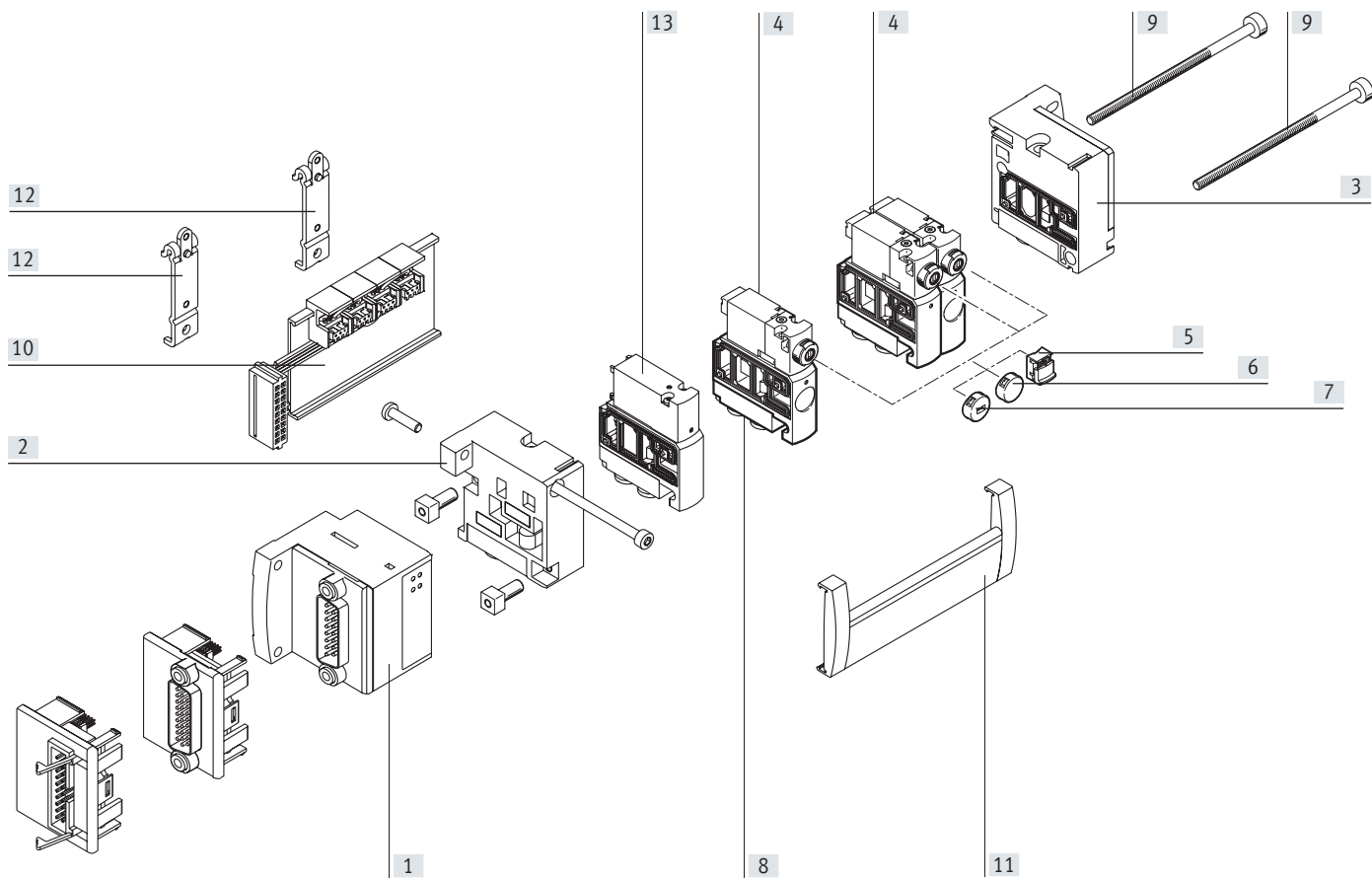

- [1] Electrical control unit (with LED switching status indications) for Sub-D plug or ribbon cable
- [2] Left-hand end plate for compressed air supply 1 or 12/14
- [3] Right-hand end plate for ducted exhaust air or silencer (3/5 or 82/84)

- [4] Valve
- [5] Cover cap for manual override, manually operated without accessories (code Y)

- [6] Cover cap for manual override, MO blocked (code V)
- [7] Cover cap coded, MO non-detenting (code K)
- [8] Sub-base for working ports (push-in fitting or thread)

- [9] Tie rod
- [10] Electrical valve linking module
- [11] Inscription label holder
- [12] H-rail mounting
- [13] Blanking plate for vacant position

Peripherals overview

Valve terminal with CPI connection

- CP interface M9, 5-pin
- Code: CP

Valves and end plates are the basic pneumatic components of the valve terminal. The valve terminals are connected to the end plates using tie rods.

Valve terminals with CP interface can be equipped with 4 to max. 16 valve positions. Each valve position can either be equipped with a valve or a blanking plate.

The electrical connection is in the same direction as the tubing connection in order to save space.

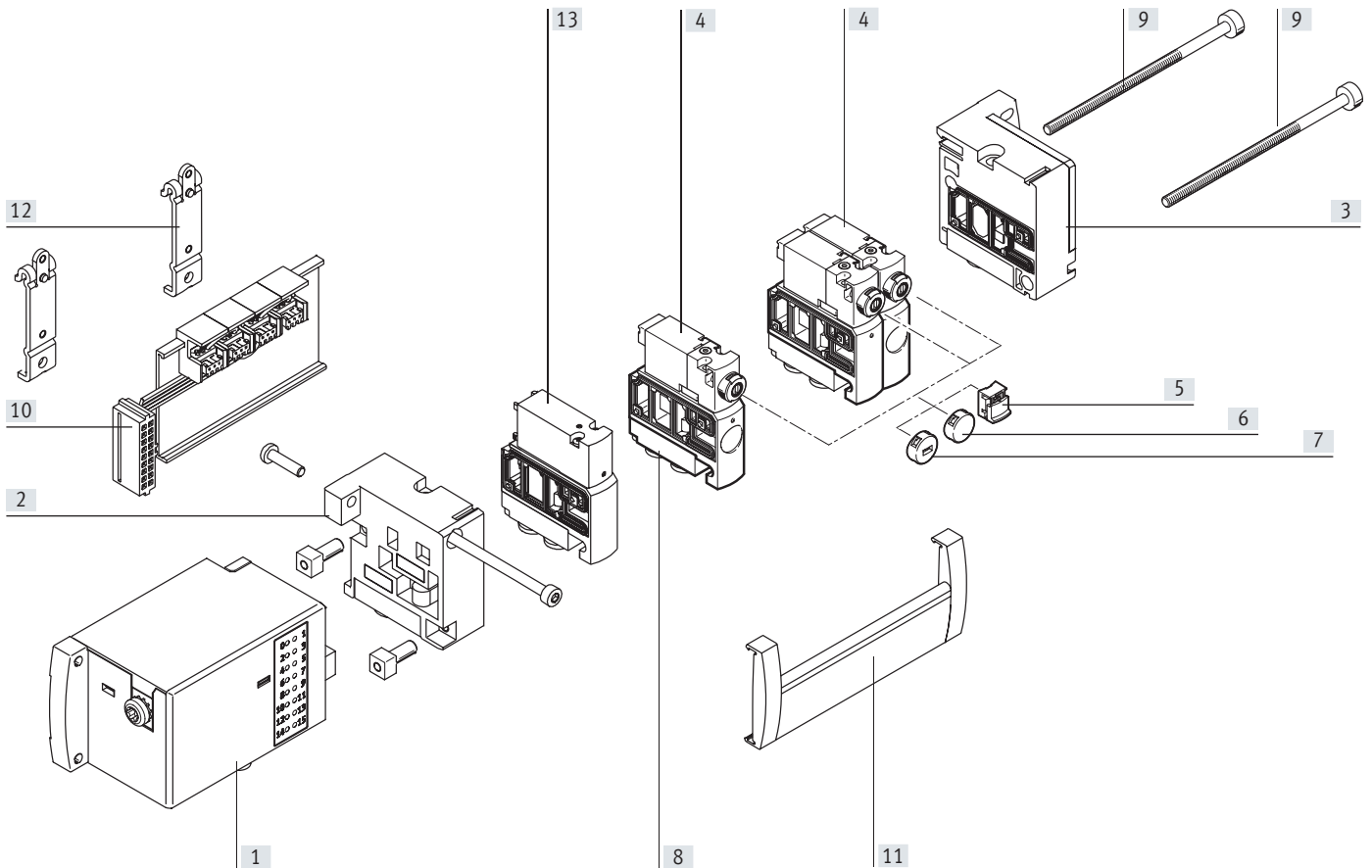

- | | | | |
|--|---|--|---|
| [1] CPI connection | [5] Cover cap for manual override, manually operated without accessories (code Y) | [7] Cover cap coded, MO non-detenting (code K) | [10] Electrical valve linking module |
| [2] Left-hand end plate for compressed air supply 1 or 12/14 | [6] Cover cap for manual override, MO blocked (code V) | [8] Sub-base for working ports (push-in fitting or thread) | [11] Inscription label holder |
| [3] Right-hand end plate for ducted exhaust air or silencer (3/5 or 82/84) | | [9] Tie rod | [12] H-rail mounting |
| [4] Valve | | | [13] Blanking plate for vacant position |

Key features – Pneumatic components

Valves

Valves CPVSC1 are valves with integrated sub-bases, i.e. in addition to the valve function they also include all ducts for supply, exhaust and for the working connections. The supply ducts

are the central component of the valve slices and enable direct through flow. This makes it possible to achieve maximum flow rates. All valves have a pneumatic pilot control for optimising

performance. The valve function is based on a piston spool system with patented sealing principle, ensuring a broad range of applications and long service life.

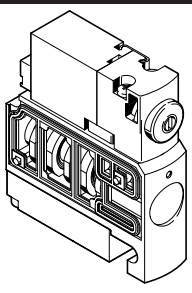
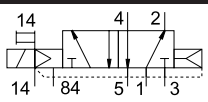
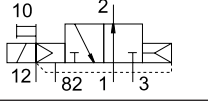
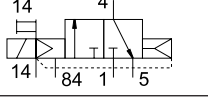
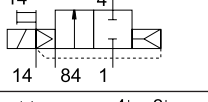
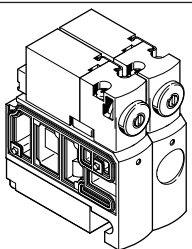
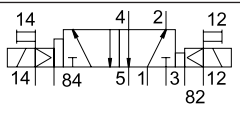
Valve functions	Code	Circuit symbol	Valve size 10 mm	Description
	M		■	5/2-way valve, single solenoid • Pneumatic spring return
	N		■	3/2-way valve, single solenoid • Normally open • Pneumatic spring return
	K		■	3/2-way valve, single solenoid • Normally closed • Pneumatic spring return
	D		■	2/2-way valve, single solenoid • Normally closed • Pneumatic spring return
	J		■	5/2-way valve, double solenoid This valve consists of two valve housings and therefore occupies two valve positions. The pilot control with coil 12 is situated on the left and marked "12". If both coils are actuated, the signal on port "14" dominates in the switching position.

 - **Note**

A filter must be installed upstream of valves operated in vacuum mode. This prevents any foreign matter in the intake air getting into the valve (e.g. when operating a suction cup with connector).

Key features – Pneumatic components

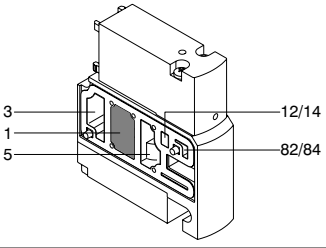
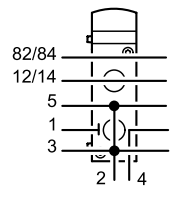
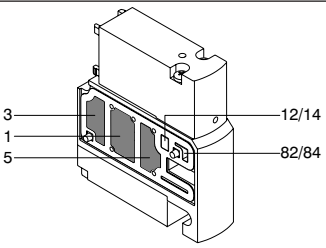
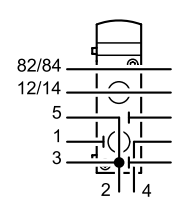
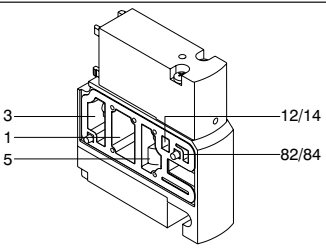
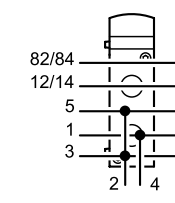
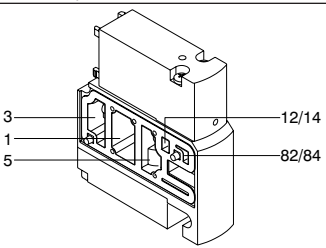
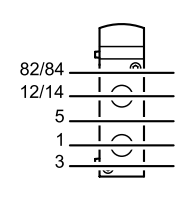
Valves Valve functions	Code	Circuit symbol	Valve size 10 mm	Description
Pneumatic supply plate with duct separation				
	T		■	Compressed air duct (1) closed For separating pressure zones with common exhaust. (Instructions for using pressure zones → page 11) Pneumatic connection QS -4, M5
	S		■	Compressed air duct (1) and exhaust duct (3/5) closed For separating pressure zones with separate exhaust. (Instructions for using pressure zones → page 11) Pneumatic connection QS -4, M5
Pneumatic supply plate without duct separation				
	U		■	Additional supply of compressed air (1) and additional exhaust (3/5). Pneumatic connection QS -4, M5
Blanking plate				
	L		■	Plate without valve function for reserving a valve position No pneumatic connection

When configuring the compressed air supply code S or T (exhaust via flat plate silencer), a push-in silencer UC-QS-4H is included for plates with supply port.

Key features – Pneumatic components

Design

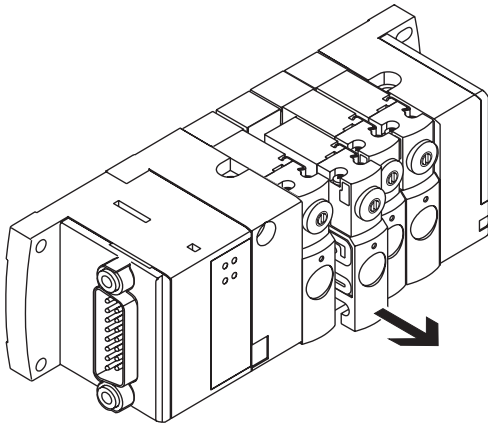

Valve replacement

Valves can be replaced quickly and easily in just a few movements. Separating seals between the valves are based on a metal support and are secured in place.

Extension

Valves can be ordered as accessories and are available with fully assembled sub-bases with QS push-in fittings or threaded connections. The valve terminal can thus be extended with additional functions by replacing blanking plates.

Valves have the valve code on the front and the product type on the back to facilitate ordering.

Materials

The valve housing and thread in the sub-bases are made of metal; further housing parts are made of sturdy plastic materials.

Note

The valve with working sub-base is a unit that has been tested for leakage by Festo.

Pilot air supply

The port for the main pneumatic supply is located on the left-hand end plate.

The ports differ for the following types of pilot air supply:

- Internal
- External

Internal pilot air supply

Internal pilot air supply can be selected if the terminal is working in an operating pressure range between 3 and 7¹⁾ bar.

The pilot air supply is then branched from the compressed air supply 1 in the left-hand end plate using an internal connection. Port 12/14 is sealed with a blanking plug.

External pilot air supply

External pilot air supply must be used if the valve terminal CPV-SC is working in an operating pressure range of –0.9 to 3 bar. In this case, the pilot air is additionally supplied via port 12/14 on the left-hand end plate.

1) 8 bar upon request

Creating pressure zones and separating exhaust air

The valve terminal CPV-SC can be operated with several pressure zones. For more than two pressure zones, a supply port with duct separation is required for each additional pressure zone. It always occupies one valve

position. An isolating disc T is used to separate the compressed air supply for groups of valves situated to the left and right of the compressed air supply. The pressure zone on the right is supplied at port 4 of the supply plate. Port

2 allows additional exhausting of the left-hand pressure zone. All exhaust ducts for the valves are connected to one another and exhausted via the right-hand end plate. An isolating disc S is used to separate the two exhaust

ducts 3 and 5 in addition to the pressure duct 1.

Note

Larger cylinders or those operated simultaneously generate a backpressure in the exhaust duct of the valve terminal; the level of this pressure depends on the exhaust capacity of the silencer. In order to prevent interaction with adjacent valves, valves

can be separated by means of duct separation using isolating disc S. The pressure zone situated to the left of an isolating disc S is exhausted via the supplied push-in silencer. If there are more than two valves in such a pressure zone, a further supply port

with additional exhaust may be necessary. It is therefore advantageous to have higher exhaust requirements in the pressure zone that is exhausted through the right-hand end plate.

Key features – Pneumatic components

Creating pressure zones		Code	Description
		S	Ducts 1 and 3/5 separated
		T	Duct 1 separate

Pneumatic working ports		Code	Description
Working port			
		B	M5 threaded connection
		E	QS-3 push-in connector
		F	QS-4 push-in connector
Supply port, left-hand end plate			
		C	Threaded connection <ul style="list-style-type: none"> • M7 (internal pilot air supply) • M5 and M7 (external pilot air supply)
		G	Push-in connector <ul style="list-style-type: none"> • QS-6 (internal pilot air supply) • QS-4 and QS-6 (external pilot air supply)

Key features – Pneumatic components

Ports for supply and exhaust

Supply and exhaust

A basic feature of a CPV-SC valve terminal are the two end plates. The left-hand end plate is for compressed air supply and the right-hand one is for exhausting the valve terminal. The exhaust air escapes optionally through an integrated flat plate silencer, a round silencer or through a push-in or threaded connection.

Connections for exhaust

Code	Description
S	<ul style="list-style-type: none"> Internal pilot air supply Exhaust from duct 3/5 an 82/84 via a flat plate silencer Replacement part (insert) for flat plate silencer type CPVSC1-UA
T	<ul style="list-style-type: none"> External pilot air supply Exhaust from duct 3/5 an 82/84 via a flat plate silencer Replacement part (insert) for flat plate silencer type CPVSC1-UA
V	<ul style="list-style-type: none"> Internal pilot air supply Exhaust from duct 3/5 and 82/84 via ducted exhaust air
X	<ul style="list-style-type: none"> External pilot air supply Exhaust from duct 3/5 and 82/84 via ducted exhaust air
Y	<ul style="list-style-type: none"> Internal pilot air supply Exhaust from duct 3/5 and 82/84 via round silencer
Z	<ul style="list-style-type: none"> External pilot air supply Exhaust from duct 3/5 and 82/84 via round silencer

Key features – Pneumatic components

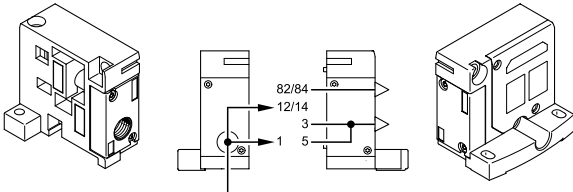
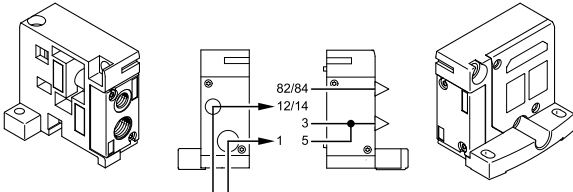
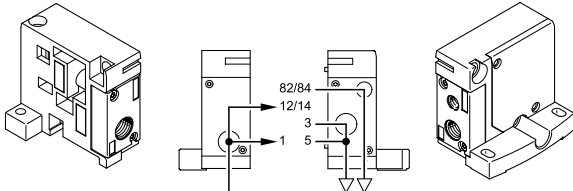
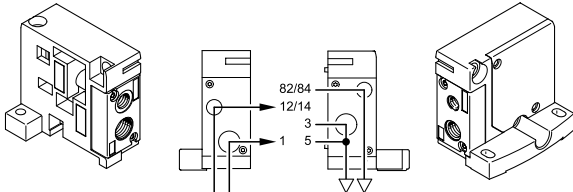
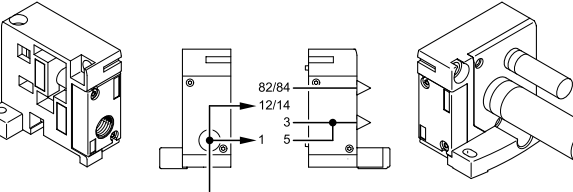
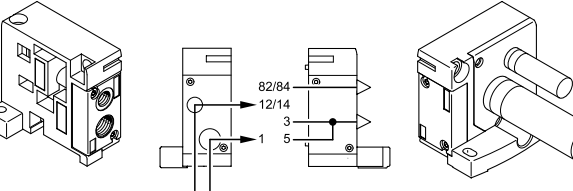
Pneumatic supply End plate combination	Code	Description
	S	Internal pilot air supply Flat plate silencer For operating pressure in the range 3 ... 7 bar
	T	External pilot air supply Flat plate silencer For operating pressure in the range -0.9 ... +7 bar
	V	Internal pilot air supply Ducted exhaust air For operating pressure in the range 3 ... 7 bar
	X	External pilot air supply Ducted exhaust air For operating pressure in the range -0.9 ... +7 bar
	Y	Internal pilot air supply Round silencer For operating pressure in the range 3 ... 7 bar
	Z	External pilot air supply Round silencer For operating pressure in the range -0.9 ... +7 bar

Key features – Electrical components

Protective circuit

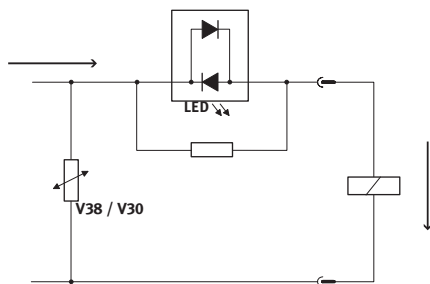

Each solenoid coil is protected with a spark arresting protective circuit as well as against polarity reversal.

Electrical multi-pin plug connection

There are two multi-pin connection types to choose from for valve terminal CPV-SC:

- Sub-D multi-pin plug connection (15- and 26-pin) or
- Multi-pin plug connection with contact strip for ribbon cable (20-pin)

The CPV-SC is connected via a multi-pin connection with Sub-D or ribbon cable. Each pin of the multi-pin plug is allocated to max. one valve position and thus to one coil or address.

Double-solenoid valves "J" occupy two valve positions. The left-hand valve position with pilot control 12 is controlled by the lower of the two address values.

Electrical multi-pin plug connection – Sub-D

Code MS, MH

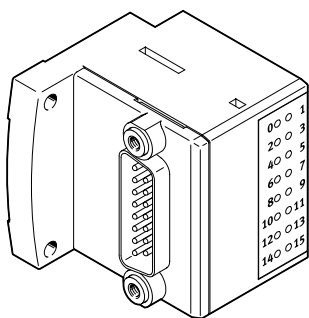



With this electrical connection variant, all valves are controlled centrally via the 15- and 26-pin connector plug. The electrical connection is located on the left-hand side.

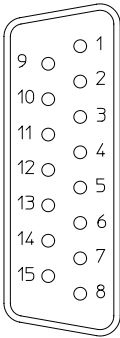

Ordering data – Sub-D connecting cable

	Code	Description	Length [m]	Part no.	Type
	CP	15-pin for 12 coils (code MS)	2.5	527543	KMP6-15P-12-2.5
	CQ	Material: PVC	5	527544	KMP6-15P-12-5
	CR		10	527545	KMP6-15P-12-10
	CP	26-pin for 16 coils (code MH)	2.5	527546	KMP6-26P-16-2.5
	CQ	Material: PVC	5	527547	KMP6-26P-16-5
	CR		10	527548	KMP6-26P-16-10

Key features – Electrical components

Pin allocation for 15-pin Sub-D (code MS) KMP6-15P-12-...		Description	Pin	Wire colour	Address/coil
	Plug socket with cable for the valve terminal CPV-SC with max. 12 valve positions	 Note The drawing shows a view of the Sub-D socket on the multi-pin cable KMP6-15P-12-...	1	White	Coil 0
			2	Brown	Coil 1
			3	Green	Coil 2
			4	Yellow	Coil 3
			5	Grey	Coil 4
			6	Pink	Coil 5
			7	Blue	Coil 6
			8	Red	Coil 7
			9	Black	Coil 8
			10	Violet	Coil 9
			11	Grey-pink	Coil 10
			12	Red-blue	Coil 11
			13	White-green	n.c.
			14	Brown-green	0 V ¹⁾
			15	White-yellow	0 V ¹⁾

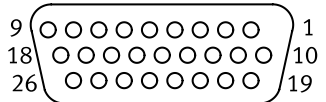
- 1) Pin 14 to pin 15 are bridged in the valve terminal
 0 V for positive switching control signals; 24 V can be connected for negative switching control signals

Pin allocation for 26-pin Sub-D (code MH) KMP6-26P-16-...		Description	Pin	Wire colour	Allocation
	Plug socket with cable for the valve terminal CPV-SC with 16 valve positions	 Note The drawing shows a view of the Sub-D socket on the multi-pin cable KMP6-26P-12-...	1	White	Coil 0
			2	Brown	Coil 1
			3	Green	Coil 2
			4	Yellow	Coil 3
			5	Grey	Coil 4
			6	Pink	Coil 5
			7	Blue	Coil 6
			8	Red	Coil 7
			9	Black	Coil 8
			10	Violet	Coil 9
			11	Grey-pink	Coil 10
			12	Red-blue	Coil 11
			13	White-green	Coil 12
			14	Brown-green	Coil 13
			15	White-yellow	Coil 14
			16	Yellow-brown	Coil 15
			17	–	n.c.
			18	–	n.c.
			19	–	n.c.
			20	–	n.c.
			21	–	n.c.
			22	–	n.c.
			23	White-grey	0 V ¹⁾
			24	Grey-brown	0 V ¹⁾
			25	White-pink	0 V ¹⁾
			26	Pink-brown	0 V ¹⁾

- 1) Pin 17 to pin 22 are bridged in the valve terminal
 0 V for positive switching control signals; 24 V can be connected for negative switching control signals

Key features – Electrical components

Electrical multi-pin plug connection – Connector for ribbon cable

Code MF

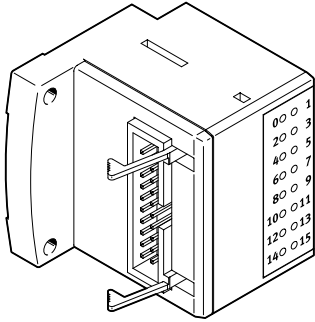

With this electrical connection variant, all valves are controlled centrally via the 20-pin connector plug. The electrical connection is located on the left-hand side.

Pin allocation – Connector for ribbon cable (code MF)

		Pin	Allocation
	Valve terminal CPV-SC with up to 16 valve positions and 20-pin multi-pin socket for ribbon cables to DIN 41561-1, -2 or IEC 60603-13-C020FD-7C1E-2G	1	Coil 0
	Contact surface gold Ribbon cable with grid of 1.27 mm Conductor cross section 0.13 mm ²	2	Coil 1
		3	Coil 2
		4	Coil 3
		5	Coil 4
		6	Coil 5
		7	Coil 6
		8	Coil 7
		9	Coil 8
		10	Coil 9
		11	Coil 10
		12	Coil 11
		13	Coil 12
		14	Coil 13
		15	Coil 14
		16	Coil 15
		17	0 V ¹⁾
	18	0 V ¹⁾	
	19	0 V ¹⁾	
	20	0 V ¹⁾	

1) Pin 17 to pin 20 are bridged in the valve terminal.

Key features – Electrical components

CP connection

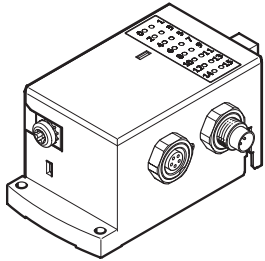

All CP valve terminals and CP modules are connected using a ready-to-install CP cable, and are attached to the CP interface. Four modules in each case, for example one valve terminal CPV-SC and one to three CP input modules, make up an installation string that ends at the CP interface.

The installation system supports a maximum of 4 installation strings that can be connected to a bus node. The CP interface of CPV-SC is represented in the CP/CPI system as a module having 16 outputs.

Additional information
→ Internet: ctec

Address allocation – Solenoid coils

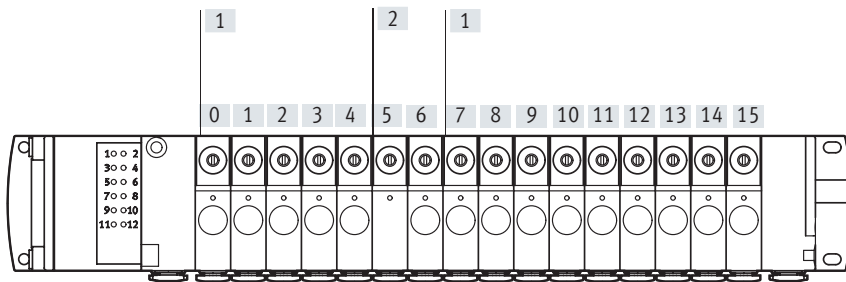

Example:

Valve terminal in which valve positions 5 and 6 are prepared for a double-solenoid valve.

[1] Single solenoid valves occupy one valve position

[2] Double-solenoid valves occupy two valve positions

Addresses are allocated to valve positions on the CPV-SC from left to right. Each valve position occupies one address, regardless of whether a valve is mounted or not.

Double-solenoid valves "J" occupy two valve positions. The left-hand valve position with pilot control 12 is controlled by the lower of the two address values.

Key features – Display and operation

Display and operation

Each solenoid coil is assigned an LED on the command unit for switching status indication. Inscription labels (type MH-BZ-80x) can be applied to each valve for labelling purposes.

The manual override (MO) enables the valve to be switched when not electrically actuated or energised. The valve is switched by pushing the manual override. The set switching status can also be locked by turning the manual override.

The cover cap (detenting without accessories, code Y) can be used to operate the manual override without any tools.

A cover can be fitted over the manual override to prevent it from being accidentally activated (code V).



Note

A manually operated valve (manual override) cannot be reset electrically. Conversely, an electrically actuated valve cannot be reset using the mechanical manual override.

Manual override (MO)

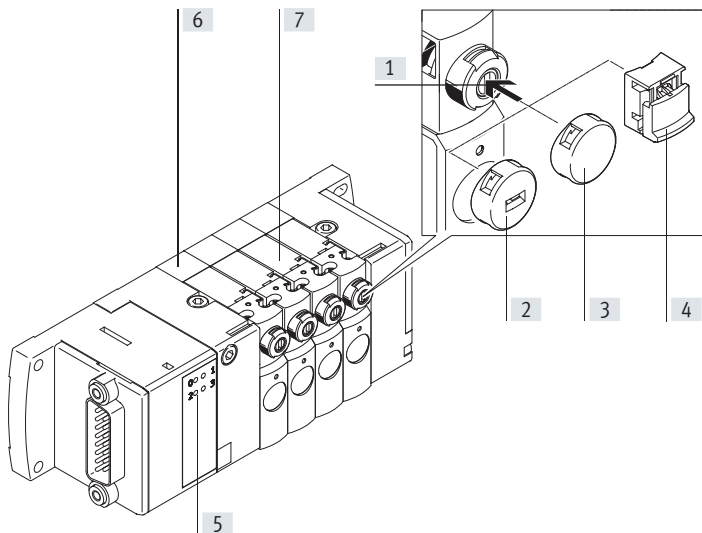

- [1] Manual override, MO non-detenting or detenting by turning (code N – without cover cap)
- [2] Cover cap coded, MO non-detenting (code K – with coded cover cap)
- [3] Cover cap for manual override, MO blocked (code V)

- [4] Cover cap, MO manually operated without accessories (code Y – with cover cap)
- [5] LED signal status indication for each valve position
- [6] Numbering of valve positions
- [7] Location for valve position inscription label (type MH-BZ-80x)

MO with automatic return (non-detenting), code N – without cover cap

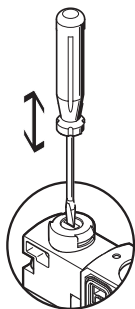

Manual override is actuated by pushing it with a pointed object or screwdriver and reset by spring force.

MO with lock (detenting), code N – without cover cap

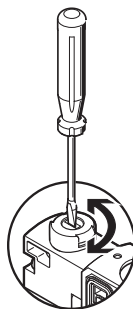

Manual override remains active until it is reset with a screwdriver.

MO with automatic return (non-detenting), code K – with coded cover cap

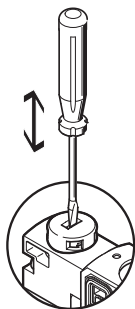

MO is actuated by pushing it with a pointed object or screwdriver and reset by spring force (detenting position prevented by coded cover cap).

MO with lock (detenting without accessories), code Y – with cover cap

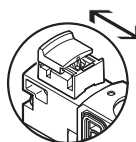

Manual override remains active until it is reset manually (without any aids).

Key features – Display and operation

Display and operation

Multi-pin

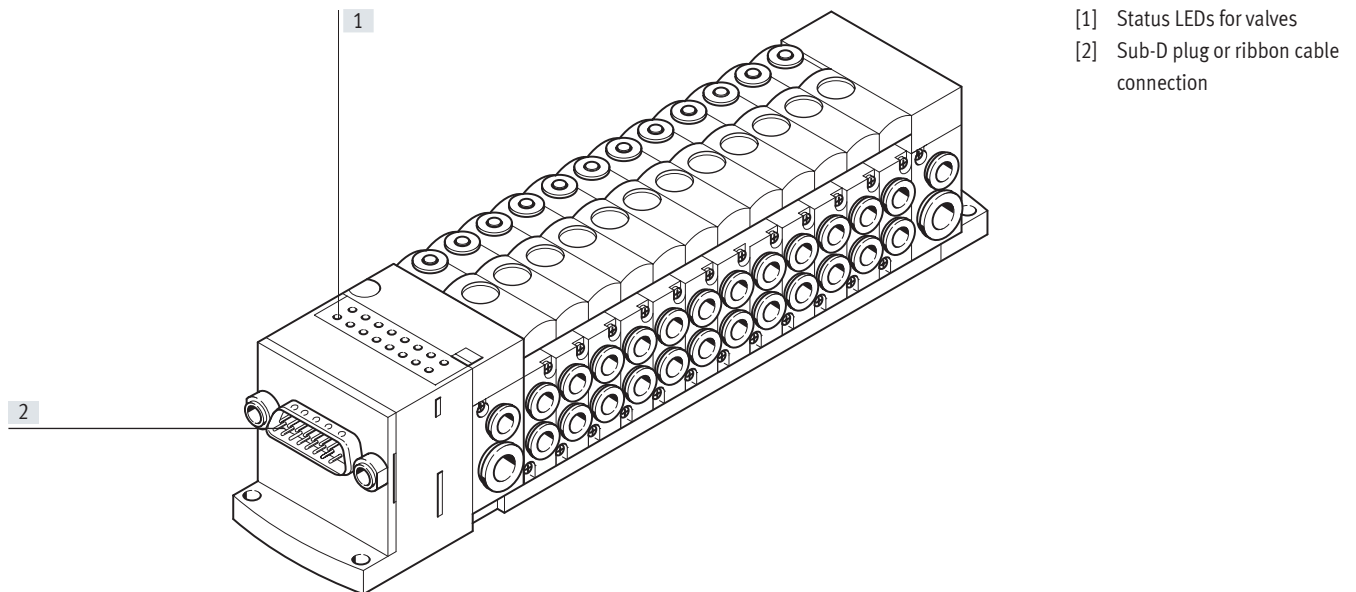

- [1] Status LEDs for valves
- [2] Sub-D plug or ribbon cable connection

CP interface

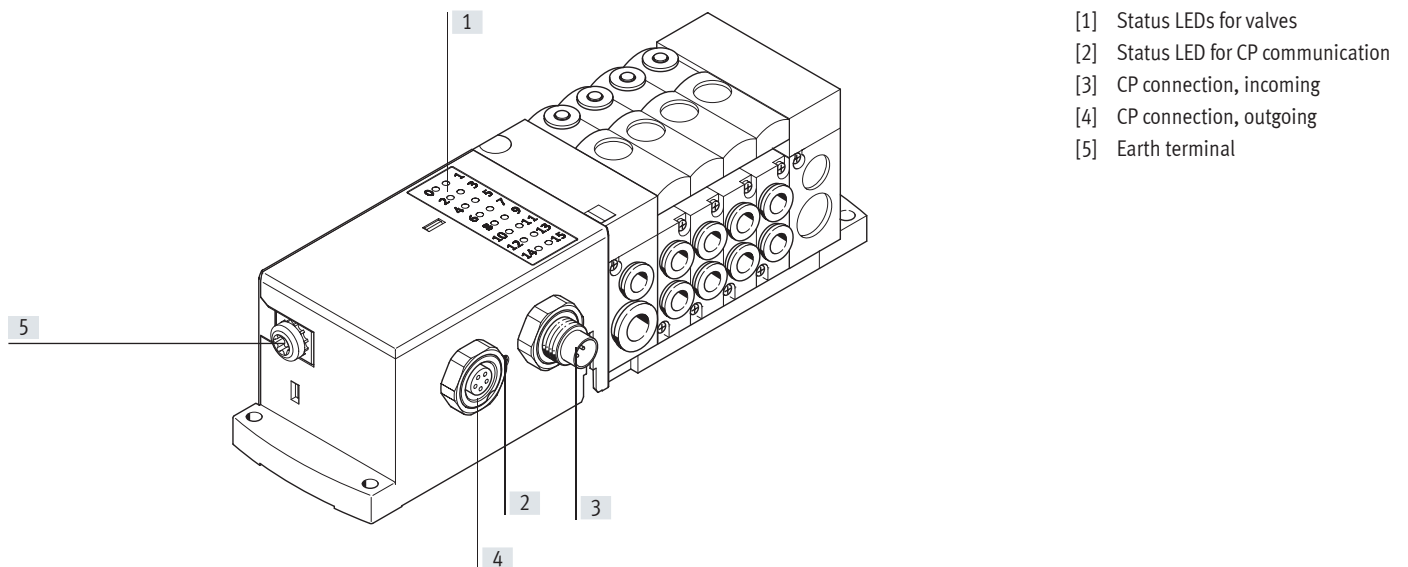

- [1] Status LEDs for valves
- [2] Status LED for CP communication
- [3] CP connection, incoming
- [4] CP connection, outgoing
- [5] Earth terminal

Inscription label holder

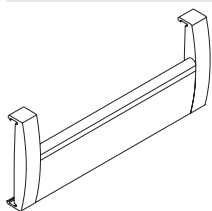

The transparent inscription label holder provides sufficient space for individually created labels on paper or film.

Labelling templates are available on the Festo website:

→ www.festo.com
in the "Downloads" area under "Software".

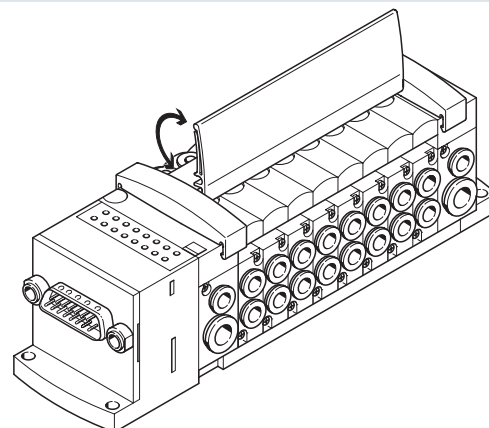

Key features – Types of mounting

Mounting – Valve terminal

Sturdy terminal mounting via:

- Four through-holes for wall mounting
- H-rail mounting

Wall mounting

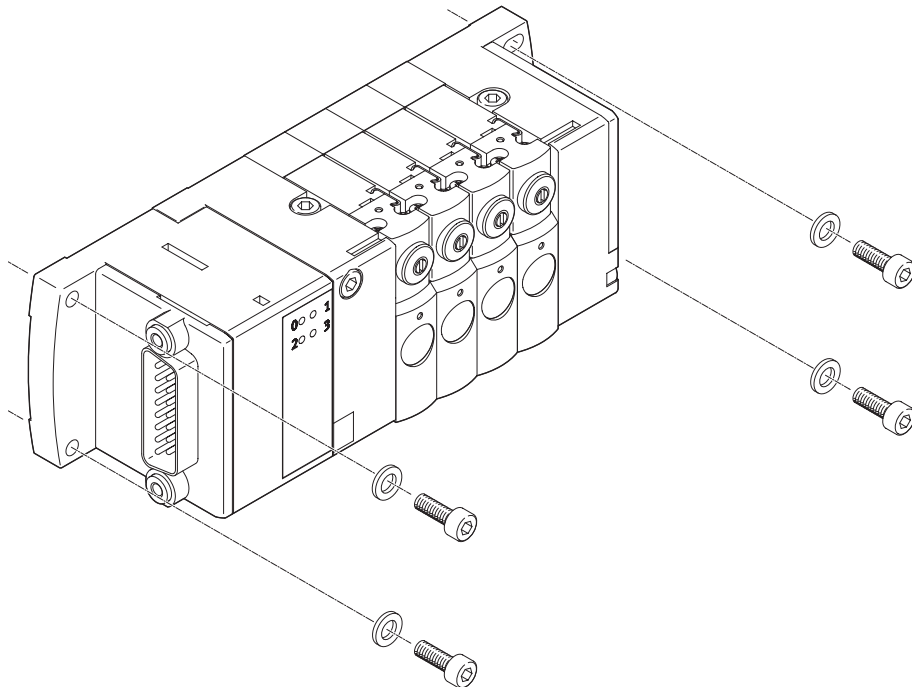

Mounting holes for screws M3

H-rail mounting

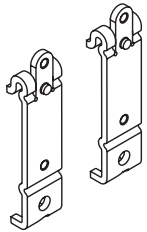

The mounting CPVSC1-HS35 facilitates mounting on an H-rail to EN 60715.

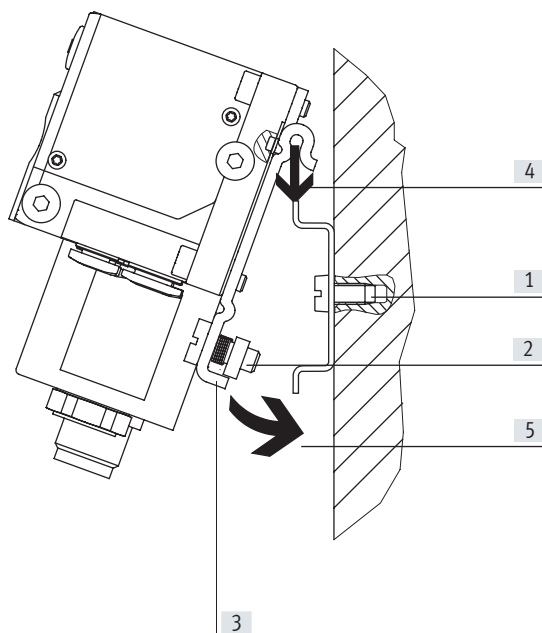

The valve terminal CPV-SC is attached to the H-rail → arrow [4].

It is then swivelled onto the H-rail and secured in place with the clamping component → arrow [5].

- [1] Holes for wall mounting
- [2] Self-tapping M4x10 screw for H-rail clamping unit
- [3] Clamping element of the H-rail clamping unit

Data sheet

Operating fluids

Operate your system with unlubricated compressed air if possible. Festo valves and cylinders are designed so that, if used as intended, they will not require additional lubrication and will still achieve a long service life.

The quality of compressed air downstream of the compressor must correspond to that of unlubricated compressed air. If possible, do not operate the entire system with lubricated compressed air. The lubricators should, where possible, always be installed directly upstream of the cylinders used.

Incorrect additional oil and too high an oil content in the compressed air reduce the service life of the valve terminal.

Use Festo special oil OFSW-32 or the alternatives listed in the Festo catalogue (as specified in DIN 51524 HLP32; basic oil viscosity 32 CST at 40°C).

Bio-oils



When using bio-oils (oils which are based on synthetic or native esters, e.g. rapeseed oil methyl ester), the maximum residual oil content of 0.1 mg/m³ must not be exceeded (see ISO 8573-1 Class 2).

Mineral oils

When using mineral oils (e.g. HLP oils to DIN 51524, parts 1 to 3) or similar oils based on poly-alpha-olefins (PAO), the maximum residual oil content of 5 mg/m³ must not be exceeded (see ISO 8573-1 Class 4).

A higher residual oil content is not permitted, regardless of the compressor oil, because the permanent lubrication would otherwise be flushed out over a period of time.

Data sheet

-  - Flow rate
170 l/min
-  - Valve width
10 mm
-  - Voltage
5, 12, 24 V DC

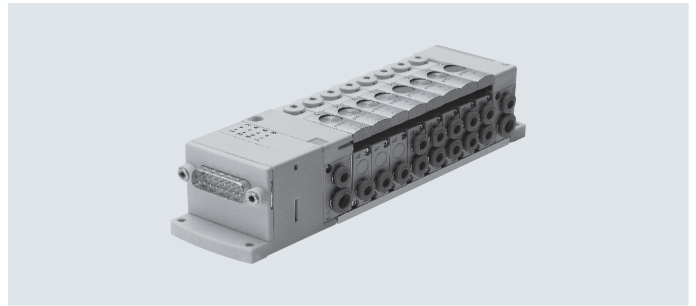

General technical data

Valve	5/2-way valve		3/2-way valve		2/2-way valve
	Single solenoid	Double solenoid	Normal position Open	Normal position Closed	Normal position Closed
Valve function order code	M	J	N	K	D
Design	Electromagnetically actuated piston spool valve				
Reset method	Pneumatic spring	-	Pneumatic spring	Pneumatic spring	Pneumatic spring
Valve size [mm]	10		10		10
Nominal width [mm]	2.5		2.5		2.5
Standard nominal flow rate [l/min]	170		170		150
Sealing principle	Soft				
Overlap	Positive overlap				
Type of control	Piloted				
Lubrication	Lifetime lubrication				
Type of mounting	Wall mounting				
Mounting position	Any				
Manual override	Non-detenting/detenting/covered				
Exhaust air function	Cannot be throttled				
Flow direction	Non-reversible				
Pneumatic connections					
Supply	1	M7, QS-6			
Exhaust port	3/5	M7, QS-6, round silencer or integrated flat plate silencer			
Working ports	2/4	Dependent on the connection type selected <ul style="list-style-type: none"> • M5 • QS-3 • QS-4 			
Pilot air connection	12/14	M5, QS-4			
Pilot exhaust air port	82/84	M5, QS-4, round silencer or integrated flat plate silencer			

Data sheet

Pilot pressure p2 as a function of working pressure p1

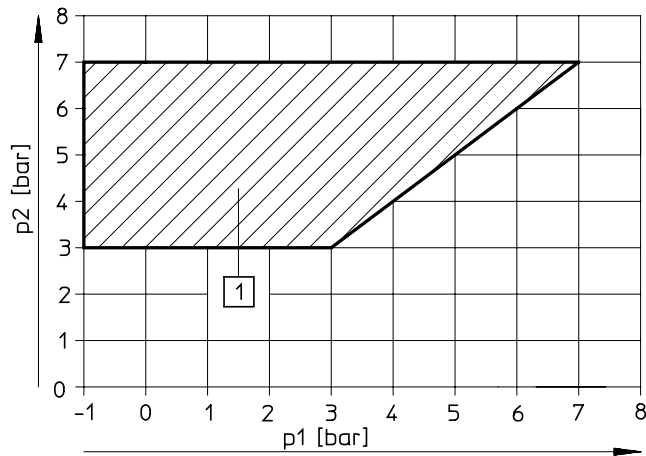

[1] Operating range for valves with external pilot air supply

Valve switching times [ms]

Valve function order code		M	J	N	K	D
Switching times	On	10	-	10	10	10
	Off	10	-	10	10	10
	Changeover	-	8	-	-	-

Operating and environmental conditions

Operating medium		Compressed air to ISO 8573-1:2010 [7:4:4] → page 21
Note on the operating/pilot medium		Lubricated operation possible (in which case lubricated operation will always be required)
PWIS criterion		Free
Certification		c UL us - Recognized (OL)
Operating pressure	[MPa]	-0.09 ... +0.7
	[bar]	-0.9 ... +7
Operating pressure for valve terminal with internal pilot air supply	[MPa]	0.3 ... 0.7
	[bar]	3 ... 7
Pilot pressure	[MPa]	0.3 ... 0.7
	[bar]	3 ... 7
Ambient temperature	[°C]	-5 ... +50
Temperature of medium	[°C]	-5 ... +50
CE marking (see declaration of conformity)		To EU EMC Directive ¹⁾
KC mark		KC EMC
Note on materials		RoHS-compliant

1) For information about the area of use, see the EC declaration of conformity at: www.festo.com/catalogue/cpv → Support/Downloads.

If the devices are subject to usage restrictions in residential, commercial or light-industrial environments, further measures for the reduction of the emitted interference may be necessary.

Data sheet

Electrical data		
Electrical control	Individual connection	
	Multi-pin	
	CP fieldbus	
Electromagnetic compatibility of the valve terminal CPV-SC with Sub-D or ribbon cable connection		Interference emission tested to DIN EN 61000-6-4, industry Interference immunity ¹⁾ tested to DIN EN 61000-6-2, industry
Protection against electric shock (protection against direct and indirect contact as per EN 60204-1/IEC 204)		Via PELV power supply
Nominal operating voltage	Multi-pin plug connection [V DC]	24
	Individual connection [V DC]	5, 12, 24
Permissible voltage fluctuations	[%]	±10
Characteristic coil data	Nominal voltage [V DC]	5, 12, 22, 24
	Electrical power consumption [W]	1
Duty cycle ED		100% at 40°C ambient temperature
Degree of protection to EN 60529		IP40 (in assembled state and with detenting plug)
Relative humidity	[%]	90% at 40°C, non-condensing

1) The maximum signal cable length is 10 m

Materials	
Electrical interface	Polymer
End plate, electrical sub-base	Polymer
Seals	NBR
Valve sub-base	Die-cast aluminium
Sub-base for working ports	PA

Product weight [g]	
Single solenoid valves (code M, N, K, D)	30.5
Double solenoid valves (code J)	56.5
Vacant position	22.5
Right-hand end plate	42.5
Left-hand end plate	28
Actuator housing	43
Tie rod, 16-fold	29.6
Electrical manifold module, 16-fold	64
Electrical interface CPI	150

Data sheet

Dimensions – With individual connection

Download CAD data → www.festo.com

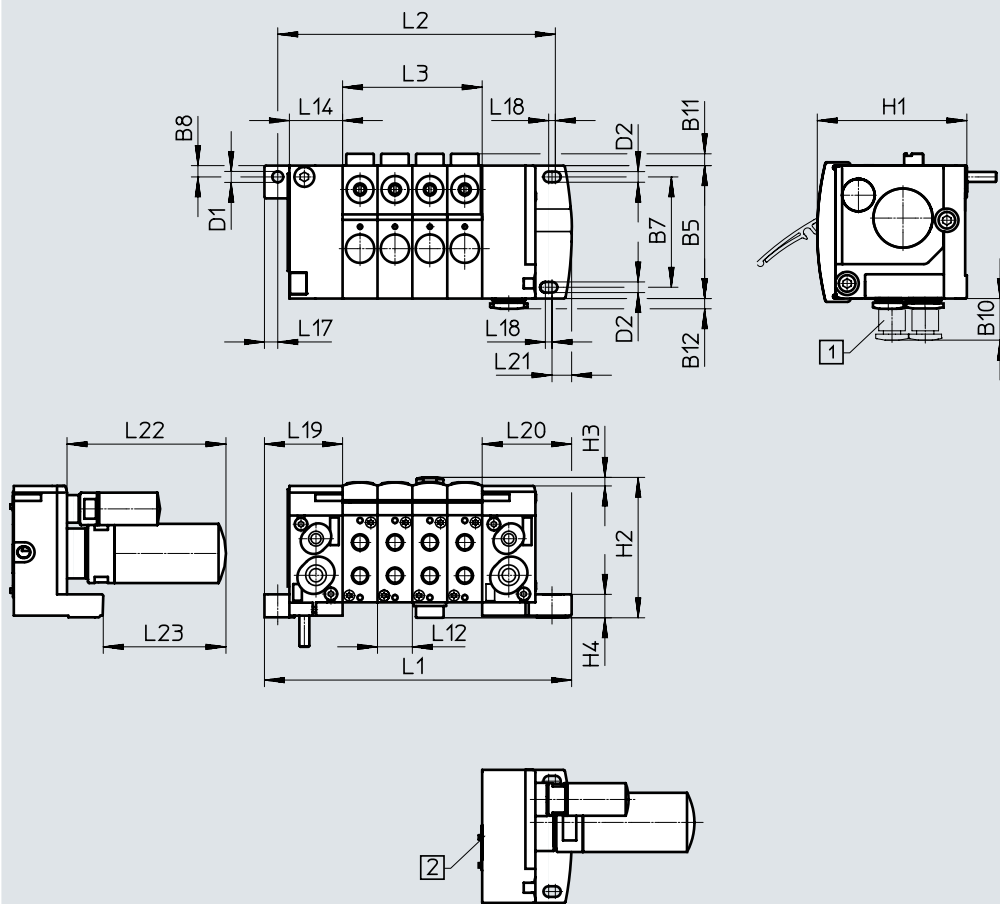

[1] QS fitting

[2] End plate with silencer

Type	B5	B7	B8	B10	B11	B12	D1 ∅	D2 ∅
With individual connection	40	33.2	3.4	10.5	3.6	3.1	3.3	3.2

Type	H1	H2	H3	H4	L12	L14	L17	L18	L19	L20	L21	L22	L23
With individual connection	45	42.2	2.6	6.9	10.5	16	4	2	23.5	26.9	4.9	48	37

Valve positions n	L1	L2	L3
2	71.4	62.5	21
3	81.9	73	31.5
4	92.4	83.5	42
5	102.9	94	52.5
6	113.4	104.5	63
7	123.9	115	73.5
8	134	125.1	84
9	144.9	136	94.5
10	155.4	146.5	105
11	165.9	157	115.5
12	176.4	167.5	126
13	186.9	178	136.5
14	197.4	188.5	147
15	207.9	199	157.5
16	218.4	209.5	168

Data sheet

Dimensions – With multi-pin plug connection

Download CAD data → www.festo.com

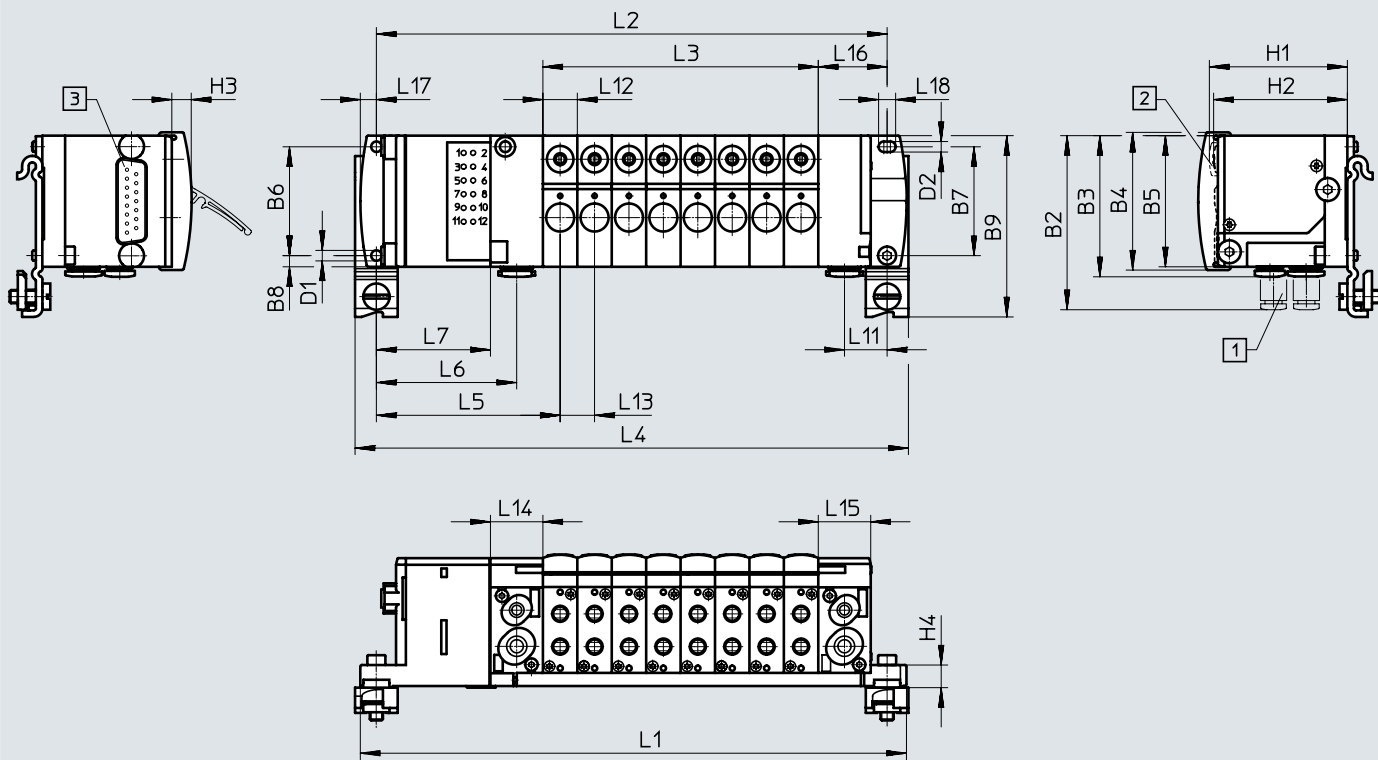

[1] QS fitting

[2] Cover cap

[3] Multi-pin connection with 20-pin ribbon cable or 15/26-pin Sub-D multi-pin connection

Type	B2	B3	B4	B5	B6	B7	B8	B9	D1 ∅	D2 ∅
With multi-pin plug connection	53.5	43.5	42	40	33.2	33.2	3.4	55.3	3.2	3.2

Type	H1	H2	H3	H4	L5	L6	L7	L11	L12	L13	L14	L15	L16	L17	L18
With multi-pin plug connection	43.4	42.1	6	6.9	56.1	42.8	34.8	13	10.5	10.5	16	16	21	4.9	5.2

Valve positions n	L1	L2	L3
4	125	114	42
5	135.5	124.5	52.5
6	146	135	63
7	146.5	145.5	73.5
8	167	156	84
9	177.5	166.5	94.5
10	188	177	105
11	198.5	187.5	115.5
12	209	198	126
13	219.5	208.5	136.5
14	230	219	147
15	240.5	229.5	157.5
16	251	240	168

Data sheet

Dimensions – Sub-D plug with cable

Download CAD data → www.festo.com

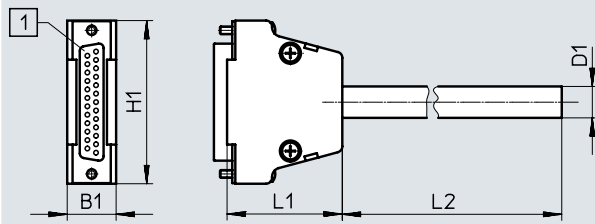

[1] 15/26-pin plug

Type	B1	D1	H1	L1	L2			Number of pins
KMP6-15P-12-...	16	8.5	40	34.5	2500	5000	10000	15
KMP6-26P-16-...	16	8.6	40	34.5	2500	5000	10000	26

Accessories

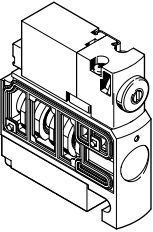
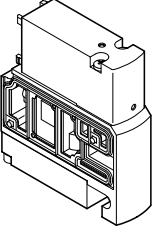
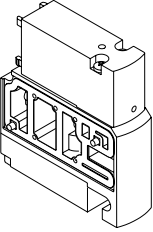
Ordering data – Valves with electrical plug-in connection		Part no.	Type
	Solenoid valve with M5 connections		
	5/2-way valve, single solenoid	527550	CPVSC1-M1H-M-P-M5
	5/2-way valve, double solenoid	527553	CPVSC1-M1H-J-P-M5
	3/2-way valve, normally open	527551	CPVSC1-M1H-N-P-M50
	3/2-way valve, normally closed	527552	CPVSC1-M1H-K-P-M5C
	2/2-way valve, normally closed	527554	CPVSC1-M1H-D-P-M5C
	Solenoid valve with QS-3 push-in connectors		
	5/2-way valve, single solenoid	527555	CPVSC1-M1H-M-P-Q3
	5/2-way valve, double solenoid	527558	CPVSC1-M1H-J-P-Q3
	3/2-way valve, normally open	527556	CPVSC1-M1H-N-P-Q30
	3/2-way valve, normally closed	527557	CPVSC1-M1H-K-P-Q3C
	2/2-way valve, normally closed	527559	CPVSC1-M1H-D-P-Q3C
	Solenoid valve with QS-4 push-in connectors		
	5/2-way valve, single solenoid	527560	CPVSC1-M1H-M-P-Q4
	5/2-way valve, double solenoid	527563	CPVSC1-M1H-J-P-Q4
3/2-way valve, normally open	527561	CPVSC1-M1H-N-P-Q40	
3/2-way valve, normally closed	527562	CPVSC1-M1H-K-P-Q4C	
2/2-way valve, normally closed	527564	CPVSC1-M1H-D-P-Q4C	
	Plates with integrated connections		
	Vacant position, with cover plate	527527	CPVSC1-RP-B
	Supply plate M5		
	Duct 1 separate	527528	CPVSC1-SP-P-M5
	Duct 1/3/5 separate	527530	CPVSC1-SP-PRS-M5
	Without duct separation	527532	CPVSC1-SP-M5
	Supply plate, QS-4 push-in connector		
	Duct 1 separate	527529	CPVSC1-SP-P-Q4
	Duct 1/3/5 separate	527531	CPVSC1-SP-PRS-Q4
	Without duct separation	527533	CPVSC1-SP-Q4

Accessories

Ordering data – Valves with individual electrical connection, detenting manual override, plug at top, 24 V DC

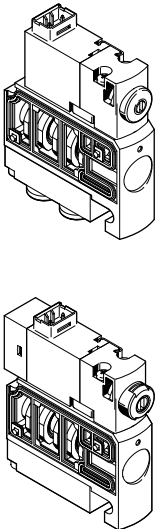
	Part no.	Type	
	Solenoid valve with M5 connections		
	5/2-way valve, single solenoid	547276	CPVSC1-M1H-M-T-M5
	5/2-way valve, double solenoid	547277	CPVSC1-M1H-J-T-M5
	3/2-way valve, normally open	547275	CPVSC1-M1H-N-T-M50
	3/2-way valve, normally closed	547274	CPVSC1-M1H-K-T-M5C
	2/2-way valve, normally closed	547273	CPVSC1-M1H-D-T-M5C
	Solenoid valve with M5 connections and LED		
	5/2-way valve, single solenoid	547306	CPVSC1-M1LH-M-T-M5
	5/2-way valve, double solenoid	547307	CPVSC1-M1LH-J-T-M5
	3/2-way valve, normally open	547305	CPVSC1-M1LH-N-T-M50
	3/2-way valve, normally closed	547304	CPVSC1-M1LH-K-T-M5C
	2/2-way valve, normally closed	547303	CPVSC1-M1LH-D-T-M5C
	Solenoid valve with QS-3 push-in connectors		
	5/2-way valve, single solenoid	547281	CPVSC1-M1H-M-T-Q3
	5/2-way valve, double solenoid	547282	CPVSC1-M1H-J-T-Q3
	3/2-way valve, normally open	547280	CPVSC1-M1H-N-T-Q30
	3/2-way valve, normally closed	547279	CPVSC1-M1H-K-T-Q3C
	2/2-way valve, normally closed	547278	CPVSC1-M1H-D-T-Q3C
	Solenoid valve with QS-3 push-in connectors and LED		
	5/2-way valve, single solenoid	547311	CPVSC1-M1LH-M-T-Q3
5/2-way valve, double solenoid	547312	CPVSC1-M1LH-J-T-Q3	
3/2-way valve, normally open	547310	CPVSC1-M1LH-N-T-Q30	
3/2-way valve, normally closed	547309	CPVSC1-M1LH-K-T-Q3C	
2/2-way valve, normally closed	547308	CPVSC1-M1LH-D-T-Q3C	
Solenoid valve with QS-4 push-in connectors			
5/2-way valve, single solenoid	547286	CPVSC1-M1H-M-T-Q4	
5/2-way valve, double solenoid	547287	CPVSC1-M1H-J-T-Q4	
3/2-way valve, normally open	547285	CPVSC1-M1H-N-T-Q40	
3/2-way valve, normally closed	547284	CPVSC1-M1H-K-T-Q4C	
2/2-way valve, normally closed	547283	CPVSC1-M1H-D-T-Q4C	
Solenoid valve with QS-4 push-in connectors and LED			
5/2-way valve, single solenoid	547316	CPVSC1-M1LH-M-T-Q4	
5/2-way valve, double solenoid	547317	CPVSC1-M1LH-J-T-Q4	
3/2-way valve, normally open	547315	CPVSC1-M1LH-N-T-Q40	
3/2-way valve, normally closed	547314	CPVSC1-M1LH-K-T-Q4C	
2/2-way valve, normally closed	547313	CPVSC1-M1LH-D-T-Q4C	

Accessories

Ordering data – Valves with individual electrical connection, detenting manual override, plug at rear, 24 V DC

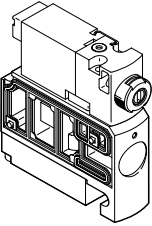
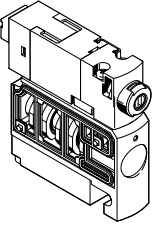
	Part no.	Type
Solenoid valve with M5 connections		
	5/2-way valve, single solenoid	547291 CPVSC1-M1H-M-H-M5
	5/2-way valve, double solenoid	547292 CPVSC1-M1H-J-H-M5
	3/2-way valve, normally open	547290 CPVSC1-M1H-N-H-M50
	3/2-way valve, normally closed	547289 CPVSC1-M1H-K-H-M5C
	2/2-way valve, normally closed	547288 CPVSC1-M1H-D-H-M5C
Solenoid valve with M5 connections and LED		
	5/2-way valve, single solenoid	547322 CPVSC1-M1LH-M-H-M5
	5/2-way valve, double solenoid	547323 CPVSC1-M1LH-J-H-M5
	3/2-way valve, normally open	547321 CPVSC1-M1LH-N-H-M50
	3/2-way valve, normally closed	547320 CPVSC1-M1LH-K-H-M5C
	2/2-way valve, normally closed	547318 CPVSC1-M1LH-D-H-M5C
Solenoid valve with QS-3 push-in connectors		
	5/2-way valve, single solenoid	547296 CPVSC1-M1H-M-H-Q3
	5/2-way valve, double solenoid	547297 CPVSC1-M1H-J-H-Q3
	3/2-way valve, normally open	547295 CPVSC1-M1H-N-H-Q30
	3/2-way valve, normally closed	547294 CPVSC1-M1H-K-H-Q3C
	2/2-way valve, normally closed	547293 CPVSC1-M1H-D-H-Q3C
Solenoid valve with QS-3 push-in connectors and LED		
	5/2-way valve, single solenoid	547327 CPVSC1-M1LH-M-H-Q3
	5/2-way valve, double solenoid	547328 CPVSC1-M1LH-J-H-Q3
	3/2-way valve, normally open	547326 CPVSC1-M1LH-N-H-Q30
	3/2-way valve, normally closed	547325 CPVSC1-M1LH-K-H-Q3C
	2/2-way valve, normally closed	547324 CPVSC1-M1LH-D-H-Q3C
Solenoid valve with QS-4 push-in connectors		
	5/2-way valve, single solenoid	547301 CPVSC1-M1H-M-H-Q4
	5/2-way valve, double solenoid	547302 CPVSC1-M1H-J-H-Q4
	3/2-way valve, normally open	547300 CPVSC1-M1H-N-H-Q40
	3/2-way valve, normally closed	547299 CPVSC1-M1H-K-H-Q4C
	2/2-way valve, normally closed	547298 CPVSC1-M1H-D-H-Q4C
Solenoid valve with QS-4 push-in connectors and LED		
	5/2-way valve, single solenoid	547332 CPVSC1-M1LH-M-H-Q4
	5/2-way valve, double solenoid	547333 CPVSC1-M1LH-J-H-Q4
	3/2-way valve, normally open	547331 CPVSC1-M1LH-N-H-Q40
	3/2-way valve, normally closed	547330 CPVSC1-M1LH-K-H-Q4C
	2/2-way valve, normally closed	547329 CPVSC1-M1LH-D-H-Q4C

Accessories

Ordering data – Valves with individual electrical connection, non-detenting manual override, plug at top, 24 V DC

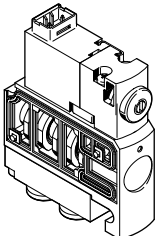
	Part no.	Type	
	Solenoid valve with M5 connections		
	5/2-way valve, single solenoid	548037	CPVSC1-M1HT-M-T-M5
	5/2-way valve, double solenoid	548038	CPVSC1-M1HT-J-T-M5
	3/2-way valve, normally open	548036	CPVSC1-M1HT-N-T-M50
	3/2-way valve, normally closed	548035	CPVSC1-M1HT-KT-M5C
	2/2-way valve, normally closed	548034	CPVSC1-M1HT-D-T-M5C
	Solenoid valve with QS-3 push-in connectors		
	5/2-way valve, single solenoid	548043	CPVSC1-M1HT-M-T-Q3
	5/2-way valve, double solenoid	548044	CPVSC1-M1HT-J-T-Q3
	3/2-way valve, normally open	548042	CPVSC1-M1HT-N-T-Q30
	3/2-way valve, normally closed	548041	CPVSC1-M1HT-KT-Q3C
	2/2-way valve, normally closed	548040	CPVSC1-M1HT-D-T-Q3C
	Solenoid valve with QS-4 push-in connectors		
	5/2-way valve, single solenoid	548048	CPVSC1-M1HT-M-T-Q4
	5/2-way valve, double solenoid	548049	CPVSC1-M1HT-J-T-Q4
3/2-way valve, normally open	548047	CPVSC1-M1HT-N-T-Q40	
3/2-way valve, normally closed	548046	CPVSC1-M1HT-KT-Q4C	
2/2-way valve, normally closed	548045	CPVSC1-M1HT-D-T-Q4C	

Ordering data – Valves with individual electrical connection, non-detenting manual override, plug at rear, 24 V DC

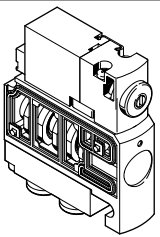
	Part no.	Type	
	Solenoid valve with M5 connections		
	5/2-way valve, single solenoid	548053	CPVSC1-M1HT-M-H-M5
	5/2-way valve, double solenoid	548054	CPVSC1-M1HT-J-H-M5
	3/2-way valve, normally open	548052	CPVSC1-M1HT-N-H-M50
	3/2-way valve, normally closed	548051	CPVSC1-M1HT-K-H-M5C
	2/2-way valve, normally closed	548050	CPVSC1-M1HT-D-H-M5C
	Solenoid valve with QS-3 push-in connectors		
	5/2-way valve, single solenoid	548058	CPVSC1-M1HT-M-H-Q3
	5/2-way valve, double solenoid	548059	CPVSC1-M1HT-J-H-Q3
	3/2-way valve, normally open	548057	CPVSC1-M1HT-N-H-Q30
	3/2-way valve, normally closed	548056	CPVSC1-M1HT-K-H-Q3C
	2/2-way valve, normally closed	548055	CPVSC1-M1HT-D-H-Q3C
	Solenoid valve with QS-4 push-in connectors		
	5/2-way valve, single solenoid	548063	CPVSC1-M1HT-M-H-Q4
	5/2-way valve, double solenoid	548064	CPVSC1-M1HT-J-H-Q4
3/2-way valve, normally open	548062	CPVSC1-M1HT-N-H-Q40	
3/2-way valve, normally closed	548061	CPVSC1-M1HT-K-H-Q4C	
2/2-way valve, normally closed	548060	CPVSC1-M1HT-D-H-Q4C	

Accessories

Ordering data – Valves with individual electrical connection, detenting manual override, plug at top, 12 V DC

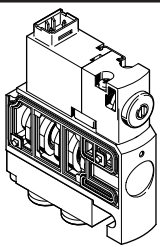
	Part no.	Type	
	Solenoid valve with M5 connections		
	5/2-way valve, single solenoid	547367	CPVSC1-M5H-M-T-M5
	5/2-way valve, double solenoid	547368	CPVSC1-M5H-J-T-M5
	3/2-way valve, normally open	547366	CPVSC1-M5H-N-T-M50
	3/2-way valve, normally closed	547365	CPVSC1-M5H-K-T-M5C
	2/2-way valve, normally closed	547364	CPVSC1-M5H-D-T-M5C
	Solenoid valve with QS-3 push-in connectors		
	5/2-way valve, single solenoid	547372	CPVSC1-M5H-M-T-Q3
	5/2-way valve, double solenoid	547373	CPVSC1-M5H-J-T-Q3
	3/2-way valve, normally open	547371	CPVSC1-M5H-N-T-Q30
	3/2-way valve, normally closed	547370	CPVSC1-M5H-K-T-Q3C
	2/2-way valve, normally closed	547369	CPVSC1-M5H-D-T-Q3C
	Solenoid valve with QS-4 push-in connectors		
	5/2-way valve, single solenoid	547377	CPVSC1-M5H-M-T-Q4
	5/2-way valve, double solenoid	547378	CPVSC1-M5H-J-T-Q4
	3/2-way valve, normally open	547376	CPVSC1-M5H-N-T-Q40
	3/2-way valve, normally closed	547375	CPVSC1-M5H-K-T-Q4C
	2/2-way valve, normally closed	547374	CPVSC1-M5H-D-T-Q4C

Ordering data – Valves with individual electrical connection, non-detenting manual override, plug at rear, 12 V DC

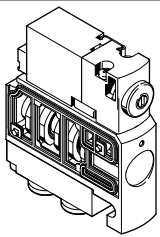
	Part no.	Type	
	Solenoid valve with M5 connections		
	5/2-way valve, single solenoid	547382	CPVSC1-M5H-M-H-M5
	5/2-way valve, double solenoid	547383	CPVSC1-M5H-J-H-M5
	3/2-way valve, normally open	547381	CPVSC1-M5H-N-H-M50
	3/2-way valve, normally closed	547380	CPVSC1-M5H-K-H-M5C
	2/2-way valve, normally closed	547379	CPVSC1-M5H-D-H-M5C
	Solenoid valve with QS-3 push-in connectors		
	5/2-way valve, single solenoid	547387	CPVSC1-M5H-M-H-Q3
	5/2-way valve, double solenoid	547388	CPVSC1-M5H-J-H-Q3
	3/2-way valve, normally open	547386	CPVSC1-M5H-N-H-Q30
	3/2-way valve, normally closed	547385	CPVSC1-M5H-K-H-Q3C
	2/2-way valve, normally closed	547384	CPVSC1-M5H-D-H-Q3C
	Solenoid valve with QS-4 push-in connectors		
	5/2-way valve, single solenoid	547392	CPVSC1-M5H-M-H-Q4
	5/2-way valve, double solenoid	547393	CPVSC1-M5H-J-H-Q4
	3/2-way valve, normally open	547391	CPVSC1-M5H-N-H-Q40
	3/2-way valve, normally closed	547390	CPVSC1-M5H-K-H-Q4C
	2/2-way valve, normally closed	547389	CPVSC1-M5H-D-H-Q4C

Accessories



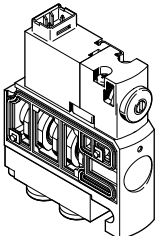

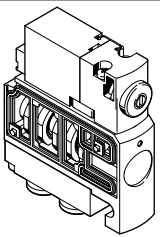

Ordering data – Valves with individual electrical connection, detenting manual override, plug at top, 5 V DC

	Part no.	Type	
	Solenoid valve with M5 connections		
	5/2-way valve, single solenoid	547337	CPVSC1-M4H-M-T-M5
	5/2-way valve, double solenoid	547338	CPVSC1-M4H-J-T-M5
	3/2-way valve, normally open	547336	CPVSC1-M4H-N-T-M50
	3/2-way valve, normally closed	547335	CPVSC1-M4H-K-T-M5C
	2/2-way valve, normally closed	547334	CPVSC1-M4H-D-T-M5C
	Solenoid valve with QS-3 push-in connectors		
	5/2-way valve, single solenoid	547342	CPVSC1-M4H-M-T-Q3
	5/2-way valve, double solenoid	547343	CPVSC1-M4H-J-T-Q3
	3/2-way valve, normally open	547341	CPVSC1-M4H-N-T-Q30
	3/2-way valve, normally closed	547340	CPVSC1-M4H-K-T-Q3C
	2/2-way valve, normally closed	547339	CPVSC1-M4H-D-T-Q3C
	Solenoid valve with QS-4 push-in connectors		
	5/2-way valve, single solenoid	547347	CPVSC1-M4H-M-T-Q4
	5/2-way valve, double solenoid	547348	CPVSC1-M4H-J-T-Q4
	3/2-way valve, normally open	547346	CPVSC1-M4H-N-T-Q40
	3/2-way valve, normally closed	547345	CPVSC1-M4H-K-T-Q4C
	2/2-way valve, normally closed	547344	CPVSC1-M4H-D-T-Q4C

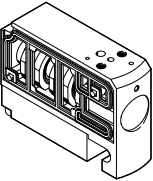

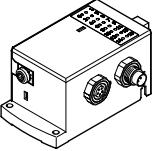
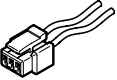
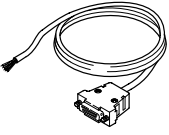
Ordering data – Valves with individual electrical connection, non-detenting manual override, plug at rear, 5 V DC

	Part no.	Type	
	Solenoid valve with M5 connections		
	5/2-way valve, single solenoid	547352	CPVSC1-M4H-M-H-M5
	5/2-way valve, double solenoid	547353	CPVSC1-M4H-J-H-M5
	3/2-way valve, normally open	547351	CPVSC1-M4H-N-H-M50
	3/2-way valve, normally closed	547350	CPVSC1-M4H-K-H-M5C
	2/2-way valve, normally closed	547349	CPVSC1-M4H-D-H-M5C
	Solenoid valve with QS-3 push-in connectors		
	5/2-way valve, single solenoid	547357	CPVSC1-M4H-M-H-Q3
	5/2-way valve, double solenoid	547358	CPVSC1-M4H-J-H-Q3
	3/2-way valve, normally open	547356	CPVSC1-M4H-N-H-Q30
	3/2-way valve, normally closed	547355	CPVSC1-M4H-K-H-Q3C
	2/2-way valve, normally closed	547354	CPVSC1-M4H-D-H-Q3C
	Solenoid valve with QS-4 push-in connectors		
	5/2-way valve, single solenoid	547362	CPVSC1-M4H-M-H-Q4
	5/2-way valve, double solenoid	547363	CPVSC1-M4H-J-H-Q4
	3/2-way valve, normally open	547361	CPVSC1-M4H-N-H-Q40
	3/2-way valve, normally closed	547360	CPVSC1-M4H-K-H-Q4C
	2/2-way valve, normally closed	547359	CPVSC1-M4H-D-H-Q4C

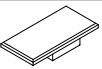
Accessories

Ordering data – Valves without pilot control				Part no.	Type	
	Valve with M5 connections					
			5/2-way valve, single solenoid	548901	CPVSC1-M-M5	
			5/2-way valve, double solenoid	548902	CPVSC1-J-M5	
			3/2-way valve, normally open	548900	CPVSC1-N-M50	
			3/2-way valve, normally closed	548899	CPVSC1-K-M5C	
			2/2-way valve, normally closed	548898	CPVSC1-D-M5C	
	Valve with push-in connectors					
			5/2-way valve, single solenoid	548906	CPVSC1-M-QX	
			5/2-way valve, double solenoid	548907	CPVSC1-J-QX	
			3/2-way valve, normally open	548905	CPVSC1-N-QXO	
		3/2-way valve, normally closed	548904	CPVSC1-K-QXC		
		2/2-way valve, normally closed	548903	CPVSC1-D-QXC		
Ordering data – Accessories				Part no.	Type	
Pilot control				Data sheets → Internet: mh1		
	3/2-way solenoid valve, normally closed	Plug connection at rear	5 V DC	–	197000	MHA1-M4H-3/2G-0.6-HC
			12 V DC	–	197001	MHA1-M5H-3/2G-0.6-HC
			24 V DC	With signal status indication	540443	MHA1-M1LH-3/2G-0.6-HC
		Plug connection on top	–	–	197002	MHA1-M1H-3/2G-0.6-HC
			5 V DC	–	197003	MHA1-M4H-3/2G-0.6-TC
			12 V DC	–	197004	MHA1-M5H-3/2G-0.6-TC
			24 V DC	With signal status indication	540444	MHA1-M1LH-3/2G-0.6-TC
			–	–	197005	MHA1-M1H-3/2G-0.6-TC
CP interface						
	Electrical interface			541975	CPVSC1-AE16-CPI	
Individual electrical connection						
	Plug socket with cable, IP40	0.5 m		566654	NEBV-H1G2-KN-0.5-N-LE2	
		1 m		566655	NEBV-H1G2-KN-1-N-LE2	
		2.5 m		566656	NEBV-H1G2-KN-2.5-N-LE2	
		5 m		566657	NEBV-H1G2-KN-5-N-LE2	
Connecting cable to IP40 for multi-pin plug connection						
	Sub-D, 15-pin, up to 12 valve positions for code MS Material: PVC	2.5 m		527543	KMP6-15P-12-2.5	
		5 m		527544	KMP6-15P-12-5	
		10 m		527545	KMP6-15P-12-10	
	Sub-D, 26-pin, up to 16 valve positions for code MH Material: PVC	2.5 m		527546	KMP6-26P-16-2.5	
		5 m		527547	KMP6-26P-16-5	
		10 m		527548	KMP6-26P-16-10	
Cover for manual override						
	Non-detenting, with coded cover cap	Pack of 10		540897	VMPA-HBT-B	
	Covered, manual override blocked	Pack of 10		540898	VMPA-HBV-B	
	Detenting, manually operated without accessories	Pack of 10		8002234	VAMC-L1-CD	
Inscription labels for valve identification						
	9x4.5 mm	Pack of 80		197259	MH-BZ-80x	

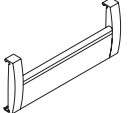
Accessories

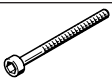
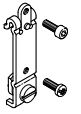
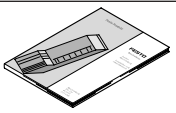
Ordering data – Accessories		Part no.	Type
Inscription label holder			
	Pack of 1	For 2 valve positions	547395 CPVSC1-ST-2
		For 3 valve positions	547396 CPVSC1-ST-3
		For 4 valve positions	527631 CPVSC1-ST-4
		For 5 valve positions	547397 CPVSC1-ST-5
		For 6 valve positions	547398 CPVSC1-ST-6
		For 7 valve positions	547399 CPVSC1-ST-7
		For 8 valve positions	527633 CPVSC1-ST-8
		For 9 valve positions	547400 CPVSC1-ST-9
		For 10 valve positions	547401 CPVSC1-ST-10
		For 11 valve positions	547402 CPVSC1-ST-11
		For 12 valve positions	527635 CPVSC1-ST-12
		For 13 valve positions	547403 CPVSC1-ST-13
		For 14 valve positions	547404 CPVSC1-ST-14
		For 15 valve positions	547405 CPVSC1-ST-15
		For 16 valve positions	527637 CPVSC1-ST-16
		Tie rod	
	Pack of 1	For 2 valve positions	547416 CPVSC1-ZA-2
		For 3 valve positions	547417 CPVSC1-ZA-3
		For 4 valve positions	532807 CPVSC1-ZA-4
		For 5 valve positions	547418 CPVSC1-ZA-5
		For 6 valve positions	547419 CPVSC1-ZA-6
		For 7 valve positions	547420 CPVSC1-ZA-7
		For 8 valve positions	532808 CPVSC1-ZA-8
		For 9 valve positions	547421 CPVSC1-ZA-9
		For 10 valve positions	547422 CPVSC1-ZA-10
		For 11 valve positions	547423 CPVSC1-ZA-11
		For 12 valve positions	532809 CPVSC1-ZA-12
		For 13 valve positions	547424 CPVSC1-ZA-13
		For 14 valve positions	547425 CPVSC1-ZA-14
		For 15 valve positions	547426 CPVSC1-ZA-15
		For 16 valve positions	532810 CPVSC1-ZA-16
		Mounting	
	Screw for additional terminal mounting	527643	M3x45
	Mounting	527639	CPVSC-HS35
User documentation			
	User documentation – Pneumatics, valve terminal CPV-SC	German	530925 P.BE-CPVSC-DE
		English	530926 P.BE-CPVSC-EN
		French	530927 P.BE-CPVSC-FR
		Spanish	530928 P.BE-CPVSC-ES
		Italian	530929 P.BE-CPVSC-IT

Festo - Your Partner in Automation



1 Festo Inc.
5300 Explorer Drive
Mississauga, ON L4W 5G4
Canada

Festo Customer Interaction Center
Tel: 1 877 463 3786
Fax: 1 877 393 3786
Email: customer.service.ca@festo.com

2 Festo Pneumatic
Av. Ceylán 3,
Col. Tequesquináhuac
54020 Tlalneantla,
Estado de México

Multinational Contact Center
01 800 337 8669
ventas.mexico@festo.com

3 Festo Corporation
1377 Motor Parkway
Suite 310
Islandia, NY 11749

Festo Customer Interaction Center
1 800 993 3786
1 800 963 3786
customer.service.us@festo.com

4 Regional Service Center
7777 Columbia Road
Mason, OH 45040

Connect with us



www.festo.com/socialmedia



www.festo.com

Subject to change