

Product data sheet

Specifications



Variable speed drive, Altivar Process ATV600, ATV650, 250 kW, 400...480 V, floor standing

ATV650C25N4F

Main

Range of product	Altivar Process ATV600
Product or component type	Variable speed drive
Product specific application	Process and utilities
Device short name	ATV650
Variant	With disconnect switch
Product destination	Synchronous motors Asynchronous motors
EMC filter	Integrated with 150 m conforming to EN/IEC 61800-3 category C3
IP degree of protection	IP54 conforming to IEC 60529 IP54 conforming to IEC 61800-5-1
[Us] rated supply voltage	380...440 V
Type of cooling	Forced convection
Supply frequency	50...60 Hz - 5...5 %
[Us] rated supply voltage	380...440 V - 15...10 %
Motor power kW	250 kW (normal duty) 200 kW (heavy duty)
Line current	391 A at 400 V (heavy duty) 319 A at 380 V (normal duty) 453 A at 380 V (heavy duty) 369 A at 400 V (normal duty)
Prospective line I _{sc}	50 kA
Apparent power	298 kVA at 440 V (normal duty) 243 kVA at 440 V (heavy duty)
Continuous output current	477 A at 2.5 kHz for normal duty 370 A at 2.5 kHz for heavy duty
Maximum transient current	525 A during 60 s (normal duty) 555 A during 60 s (heavy duty)
Asynchronous motor control profile	Optimized torque mode Constant torque standard Variable torque standard
Synchronous motor control profile	Synchronous reluctance motor Permanent magnet motor
Speed drive output frequency	0.1...500 Hz
Nominal switching frequency	2.5 kHz
Switching frequency	2...8 kHz adjustable 2.5...8 kHz with derating factor

Safety function	STO (safe torque off) SIL 3
Discrete input logic	16 preset speeds
Communication port protocol	Modbus TCP Ethernet Ethernet
Option card	Slot A: communication module, Profinet Slot A: communication module, DeviceNet Slot A: communication module, Modbus TCP/EtherNet/IP Slot A: communication module, CANopen daisy chain RJ45 Slot A: communication module, CANopen SUB-D 9 Slot A: communication module, CANopen screw terminals Slot A/slot B: digital and analog I/O extension module Slot A/slot B: output relay extension module Slot A: communication module, Ethernet IP/Modbus TCP/MD-Link Communication module, BACnet MS/TP Communication module, Ethernet Powerlink Slot A: communication module, Profibus DP V1

Complementary

Mounting mode	Floor-standing
Network number of phases	3 phases
Discrete output number	0
Discrete output type	Relay outputs R1A, R1B, R1C 250 V AC 3000 mA Relay outputs R1A, R1B, R1C 30 V DC 3000 mA Relay outputs R2A, R2C 250 V AC 5000 mA Relay outputs R2A, R2C 30 V DC 5000 mA Relay outputs R3A, R3C 250 V AC 5000 mA Relay outputs R3A, R3C 30 V DC 5000 mA
Output voltage	<= power supply voltage
Permissible temporary current boost	1.5 x I _n during 60 s (heavy duty) 1.1 x I _n during 60 s (normal duty)
Motor slip compensation	Not available in permanent magnet motor law Automatic whatever the load Adjustable Can be suppressed
Acceleration and deceleration ramps	Linear adjustable separately from 0.01...9999 s
Physical interface	Ethernet 2-wire RS 485
Braking to standstill	By DC injection
Protection type	Safe torque off: motor Motor phase break: motor Thermal protection: drive Safe torque off: drive Overheating: drive Overcurrent between output phases and earth: drive Overload of output voltage: drive Short-circuit protection: drive Motor phase break: drive Overvoltages on the DC bus: drive Line supply overvoltage: drive Line supply undervoltage: drive Line supply phase loss: drive Overspeed: drive Break on the control circuit: drive Thermal protection: motor
Transmission rate	10, 100 Mbits 4800 bps, 9600 bps, 19200 bps, 38.4 Kbps
Frequency resolution	Analog input: 0.012/50 Hz Display unit: 0.1 Hz
Transmission frame	RTU
Electrical connection	Line side: M12 bar - 2 cables 3 x 120 mm ² minimum per phase (normal duty) Line side: M12 bar - 3 cables 3 x 70 mm ² minimum per phase (normal duty) Line side: M12 bar - 3 cables 3 x 185 mm ² maximum per phase (normal duty) Line side: M12 bar - 4 cables 3 x 120 mm ² maximum per phase (normal duty) Motor: M12 bar - 2 cables 3 x 120 mm ² minimum per phase (normal duty) Motor: M12 bar - 3 cables 3 x 70 mm ² minimum per phase (normal duty) Motor: M12 bar - 3 cables 3 x 185 mm ² maximum per phase (normal duty) Motor: M12 bar - 4 cables 3 x 120 mm ² maximum per phase (normal duty) Line side: M12 bar - 2 cables 3 x 95 mm ² minimum per phase (heavy duty)

Line side: M12 bar - 3 cables 3 x 185 mm² maximum per phase (heavy duty)
 Line side: M12 bar - 4 cables 3 x 120 mm² maximum per phase (heavy duty)
 Motor: M12 bar - 1 cables 3 x 185 mm² minimum per phase (heavy duty)
 Motor: M12 bar - 2 cables 3 x 95 mm² minimum per phase (heavy duty)
 Motor: M12 bar - 3 cables 3 x 185 mm² maximum per phase (heavy duty)
 Motor: M12 bar - 4 cables 3 x 120 mm² maximum per phase (heavy duty)
 Control: removable screw terminals 0.5...1.5 mm²

Connector type	RJ45 (on the remote graphic terminal) for Modbus serial RJ45 (on the remote graphic terminal) for Ethernet/Modbus TCP
Data format	8 bits, configurable odd, even or no parity
Type of polarization	No impedance
Exchange mode	Half duplex, full duplex, autonegotiation Ethernet/Modbus TCP
Number of addresses	1...247 for Modbus serial
Method of access	Slave Modbus TCP
Supply	Internal supply for reference potentiometer (1 to 10 kOhm): 10.5 V DC +/- 5 %, <10 mA, protection type: overload and short-circuit protection Internal supply for digital inputs and STO: 24 V DC (21...27 V), <200 mA, protection type: overload and short-circuit protection External supply for digital inputs: 24 V DC (19...30 V), <1.25 mA, protection type: overload and short-circuit protection
Local signalling	3 LEDs (dual colour) for embedded communication status 4 LEDs (dual colour) for communication module status 1 LED (red) for presence of voltage 3 LEDs for local diagnostic
Width	600 mm
Height	2350 mm
Depth	669 mm
Net weight	420 kg
Analogue input number	3
Analogue input type	AI1, AI2, AI3 software-configurable voltage: 0...10 V DC, impedance: 31.5 kOhm, resolution 12 bits AI1, AI2, AI3 software-configurable current: 0...20 mA, impedance: 250 Ohm, resolution 12 bits AI2 voltage analog input: - 10...10 V DC, impedance: 31.5 kOhm, resolution 12 bits
Discrete input number	8
Discrete input type	DI7, DI8 programmable as pulse input: 0...30 kHz, 24 V DC (<= 30 V)
Input compatibility	DI5, DI6: discrete input level 1 PLC conforming to IEC 65A-68 STOA, STOB: discrete input level 1 PLC conforming to EN/IEC 61131-2 DI1...DI6: discrete input level 1 PLC conforming to EN/IEC 61131-2
Discrete input logic	Positive logic (source) (DI1...DI8), < 5 V (state 0), > 11 V (state 1) Negative logic (sink) (DI1...DI8), > 16 V (state 0), < 10 V (state 1)
Analogue output number	2
Analogue output type	Software-configurable voltage AQ1, AQ2: 0...10 V DC impedance 470 Ohm, resolution 10 bits Software-configurable current AQ1, AQ2: 0...20 mA, resolution 10 bits Software-configurable current DQ-, DQ+: 30 V DC Software-configurable current DQ-, DQ+: 100 mA
Sampling duration	5 ms +/- 1 ms (DI5, DI6) - discrete input 5 ms +/- 0.1 ms (AI1, AI2, AI3) - analog input 10 ms +/- 1 ms (AO1) - analog output 2 ms +/- 0.5 ms (DI1...DI4) - discrete input
Accuracy	+/- 1 % AO1, AO2 for a temperature variation 60 °C analog output +/- 0.6 % AI1, AI2, AI3 for a temperature variation 60 °C analog input
Linearity error	AO1, AO2: +/- 0.2 % for analog output AI1, AI2, AI3: +/- 0.15 % of maximum value for analog input
Relay output number	3
Relay output type	Configurable relay logic R2: sequence relay NO electrical durability 100000 cycles Configurable relay logic R3: sequence relay NO electrical durability 100000 cycles Configurable relay logic R1: fault relay NO/NC electrical durability 100000 cycles
Refresh time	Relay output (R1, R2, R3): 5 ms (+/- 0.5 ms)
Minimum switching current	Relay output R1, R2, R3: 5 mA at 24 V DC
Maximum switching current	Relay output R1, R2, R3 on resistive load, cos phi = 1: 3 A at 30 V DC Relay output R1, R2, R3 on inductive load, cos phi = 0.4 and L/R = 7 ms: 2 A at 250 V AC Relay output R1, R2, R3 on inductive load, cos phi = 0.4 and L/R = 7 ms: 2 A at 30 V DC

Relay output R1, R2, R3 on resistive load, cos phi = 1: 3 A at 250 V AC

Isolation	Between power and control terminals
Maximum output frequency	500 kHz
Maximum input current	453.0 A
Variable speed drive application selection	Food and beverage processing Other application Mining mineral and metal Fan Mining mineral and metal Pump Oil and gas Fan Water and waste water Other application Building - HVAC Screw compressor Food and beverage processing Pump Food and beverage processing Fan Food and beverage processing Atomization Oil and gas Electro submersible pump (ESP) Oil and gas Water injection pump Oil and gas Jet fuel pump Oil and gas Compressor for refinery Water and waste water Centrifuge pump Water and waste water Positive displacement pump Water and waste water Electro submersible pump (ESP) Water and waste water Screw pump Water and waste water Lobe compressor Water and waste water Screw compressor Water and waste water Compressor centrifugal Water and waste water Fan Water and waste water Conveyor Water and waste water Mixer Building - HVAC Compressor centrifugal
Motor power range AC-3	110...220 kW at 480...500 V 3 phases 250...500 kW at 380...440 V 3 phases
Quantity per set	1
Enclosure mounting	Floor-standing
Environment	
Insulation resistance	> 1 MOhm 500 V DC for 1 minute to earth
Noise level	70 dB conforming to 86/188/EEC
Power dissipation in W	3380 W, switching frequency 2.5 kHz (heavy duty) 5750 W, switching frequency 2.5 kHz (normal duty)
Volume of cooling air	1300 m3/h
Operating position	Vertical +/- 10 degree
Maximum THDI	<48 % full load conforming to IEC 61000-3-12
Electromagnetic compatibility	Radiated radio-frequency electromagnetic field immunity test level 3 conforming to IEC 61000-4-3 Electrical fast transient/burst immunity test level 4 conforming to IEC 61000-4-4 1.2/50 µs - 8/20 µs surge immunity test level 3 conforming to IEC 61000-4-5 Conducted radio-frequency immunity test level 3 conforming to IEC 61000-4-6 Electrostatic discharge immunity test level 3 conforming to IEC 61000-4-2
Pollution degree	2 conforming to EN/IEC 61800-5-1
Vibration resistance	1 gn (f= 13...200 Hz) conforming to IEC 60068-2-6 1.5 mm peak to peak (f= 2...13 Hz) conforming to IEC 60068-2-6
Shock resistance	15 gn for 11 ms conforming to IEC 60068-2-27
Relative humidity	5...95 % without condensation conforming to IEC 60068-2-3
Ambient air temperature for operation	40...50 °C (with derating factor) -15...40 °C (without derating)
Ambient air temperature for storage	-40...70 °C
Operating altitude	1000...4800 m with current derating 1 % per 100 m <= 1000 m without derating
Standards	EN/IEC 61800-3 Environment 2 category C3 EN/IEC 61800-3 EN/IEC 61800-5-1 IEC 61000-3-12 IEC 60721-3 IEC 61508 IEC 13849-1 UL 508C

Product certifications	TÜV CSA ATEX zone 2/22 ATEX INERIS RoHS
Marking	CE
Standards	EN/IEC 61800-3 EN/IEC 61800-3 environment 2 category C3 EN/IEC 61800-5-1 IEC 61000-3-12 IEC 60721-3 IEC 61508 IEC 13849-1 UL 508C
Overvoltage category	III
Regulation loop	Adjustable PID regulator
Noise level	70 dB
Pollution degree	3

Packing Units

Unit Type of Package 1	PCE
Number of Units in Package 1	1
Package 1 Weight	562 kg
Package 1 Height	214.5 cm
Package 1 width	120 cm
Package 1 Length	111 cm
Unit Type of Package 2	PAL
Number of Units in Package 2	1
Package 2 Weight	587 kg
Package 2 Height	228.5 cm
Package 2 width	120 cm
Package 2 Length	111 cm

Offer Sustainability

Sustainable offer status	Green Premium product
REACH Regulation	REACH Declaration
EU RoHS Directive	Pro-active compliance (Product out of EU RoHS legal scope) EU RoHS Declaration
Mercury free	Yes
RoHS exemption information	Yes
China RoHS Regulation	China RoHS declaration
Environmental Disclosure	Product Environmental Profile
Circularity Profile	End of Life Information
WEEE	The product must be disposed on European Union markets following specific waste collection and never end up in rubbish bins

Dimensions

Right and Front Views

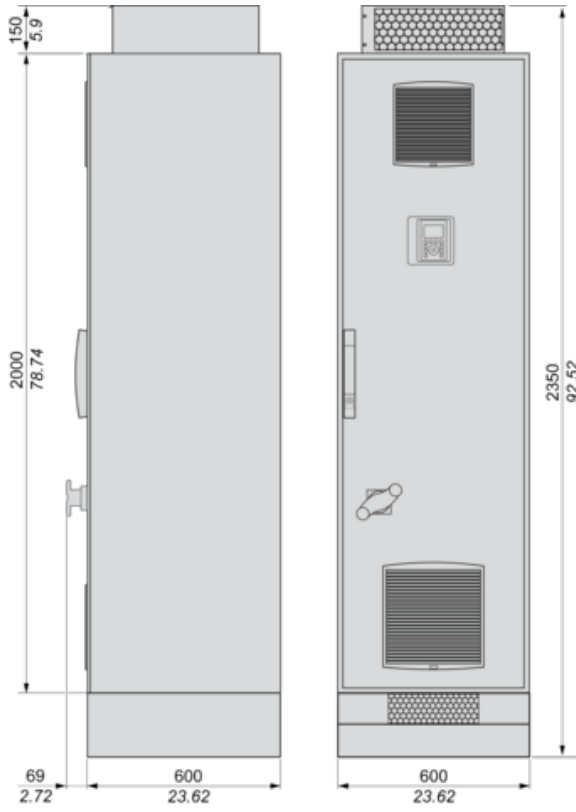

Clearances

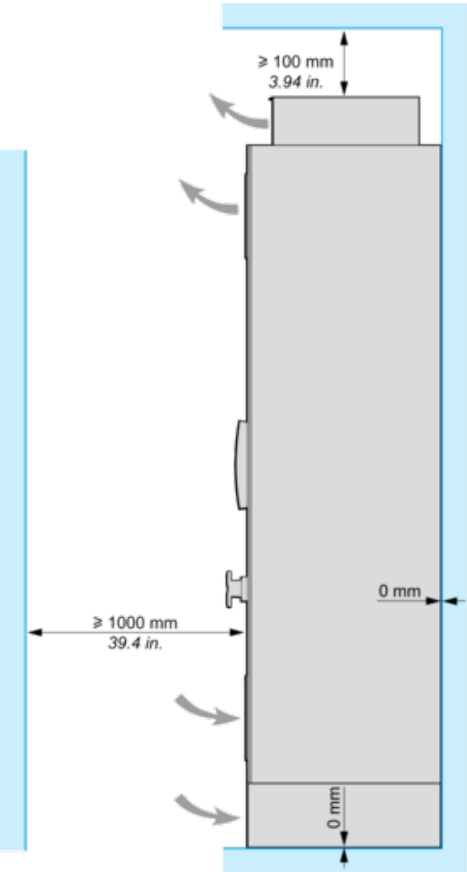

Floor Standing Drive Circuit Diagram

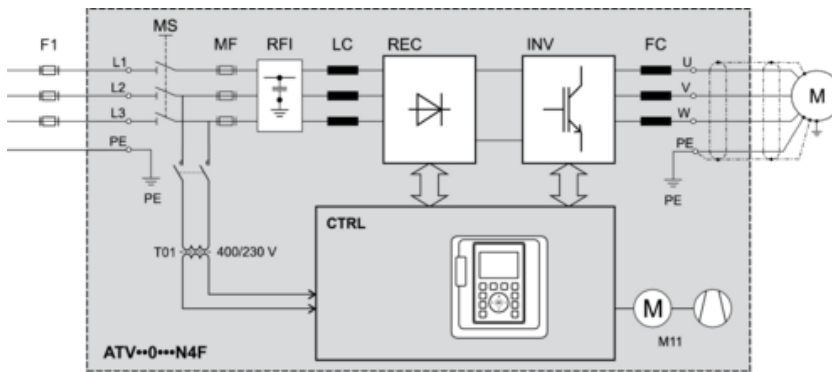

F1 External pre-fuse or circuit breaker

MS Built-in main switch (only available on IP54 drives)

T01 Control transformer 400 / 230 V AC

MF aR fuses

RFI Built-in RFI filter

LC Line reactor choke

REC Rectifier module

INV Inverter module

FC dv/dt filter (from 355 kW the dv/dt filter choke 150 m is built-in as standard)

CTRL Control panel

M11 Fan in enclosure door

Control Block Wiring Diagram

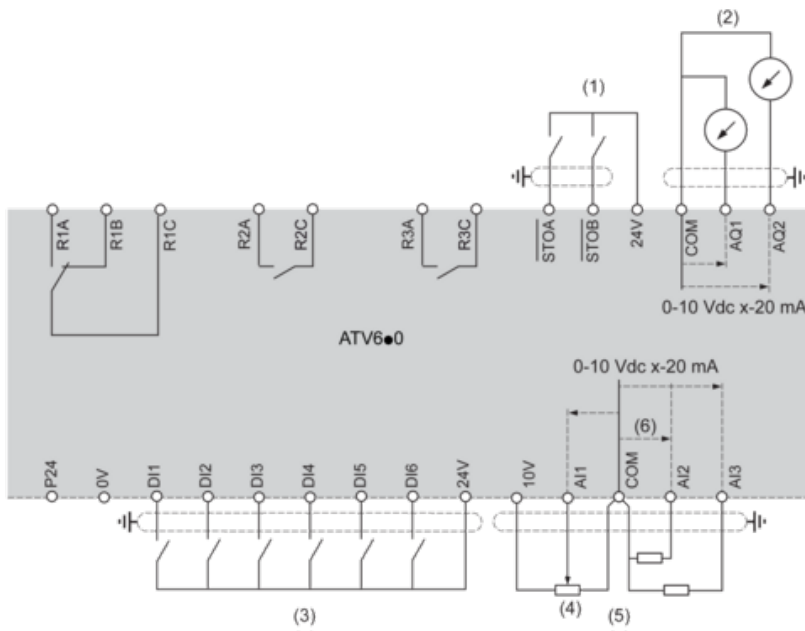

- (1) Safe Torque Off
 - (2) Analog Output
 - (3) Digital Input
 - (4) Reference potentiometer
 - (5) Analog Input
- R1A, R1B, R1C** : Fault relay
R2A, R2C : Sequence relay
R3A, R3C : Sequence relay

Sensor Connection

It is possible to connect either 1 or 3 sensors on terminals AI2 or AI3.

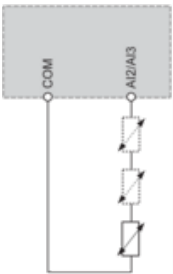

Sink / Source Switch Configuration

The switch is used to adapt the operation of the logic inputs to the technology of the programmable controller outputs.

- Set the switch to Source (factory setting) if using PLC outputs with PNP transistors.
- Set the switch to Ext if using PLC outputs with NPN transistors.

Switch Set to SRC (Source) Position Using the Output Power Supply for the Digital Inputs

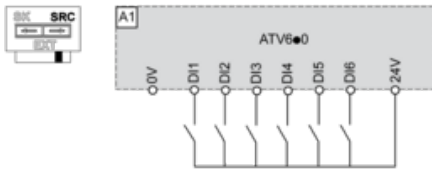

Switch Set to SRC (Source) Position and Use of an External Power Supply for the DIs

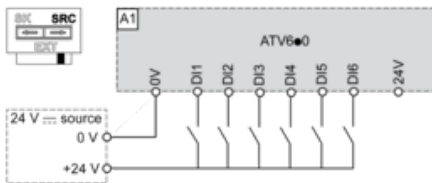

Switch Set to SK (Sink) Position Using the Output Power Supply for the Digital Inputs

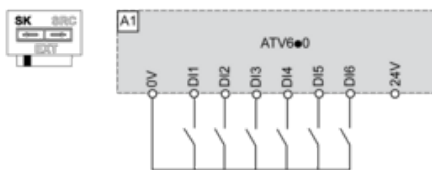

Switch Set to EXT Position Using an External Power Supply for the DIs

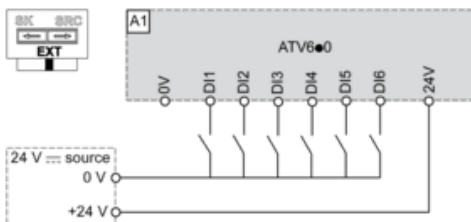

Derating Curves

Normal Duty

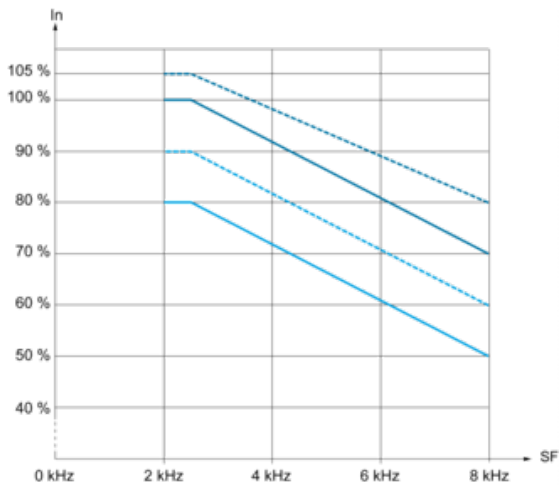

——— 30 °C (86 °F)
 ——— 40 °C (104 °F)
 - - - - 45 °C (122 °F)
 - - - - 50 °C (140 °F)C
In : Nominal Drive Current
SF : Switching Frequency

Heavy Duty

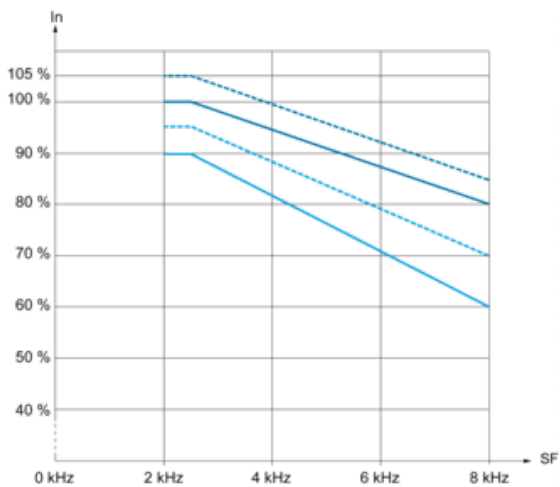

——— 30 °C (86 °F)
 ——— 40 °C (104 °F)
 - - - - 45 °C (122 °F)
 - - - - 50 °C (140 °F)C
In : Nominal Drive Current
SF : Switching Frequency