



MPQ2179

5.5V, Peak 3A, 2.4MHz, Synchronous Step-Down Converter with PG and SS, AEC-Q100 Qualified

DESCRIPTION

The MPQ2179 is a monolithic, step-down switch-mode converter with built-in internal power MOSFETs. The device achieves 3A of peak output current from a 2.5V to 5.5V input voltage range, with excellent load and line regulation. The output voltage can be regulated to as low as 0.6V.

Constant-on-time (COT) control provides fast transient response and eases loop stabilization. Fault protections include cycle-by-cycle current limiting and thermal shutdown.

The MPQ2179 is ideal for a wide range of applications, including automotive infotainment systems, clusters, and telematics.

The MPQ2179 requires a minimal number of readily available, standard external components, and is available in an ultra-small QFN-8 (1.5mmx2mm) package.

FEATURES

- Wide 2.5V to 5.5V Operating Input Voltage Range
- Up to 3A Peak Output Current
- 2.4MHz Switching Frequency
- EN for Power Sequencing
- 1% FB Accuracy
- Output Adjustable from 0.6V
- 65mΩ and 35mΩ Internal Power MOSFET Switches
- 100% Duty On
- Output Discharge
- Power Good (PG)
- External Soft Start (SS) Control
- Output Over-Voltage Protection (OVP)
- Short-Circuit Protection (SCP) with Hiccup Mode
- Forced Continuous Conduction Mode (FCCM)
- Available in a QFN-8 (1.5mmx2mm) Package
- Available in a Wettable Flank Package
- AEC-Q100 Grade 1

APPLICATIONS

- Automotive Infotainment
- Camera Modules
- Key Fobs
- Automotive Clusters
- Automotive Telematics
- Industrial Supplies
- Battery-Powered Devices

All MPS parts are lead-free, halogen-free, and adhere to the RoHS directive. For MPS green status, please visit the MPS website under Quality Assurance. "MPS", the MPS logo, and "Simple, Easy Solutions" are trademarks of Monolithic Power Systems, Inc. or its subsidiaries.

TYPICAL APPLICATION

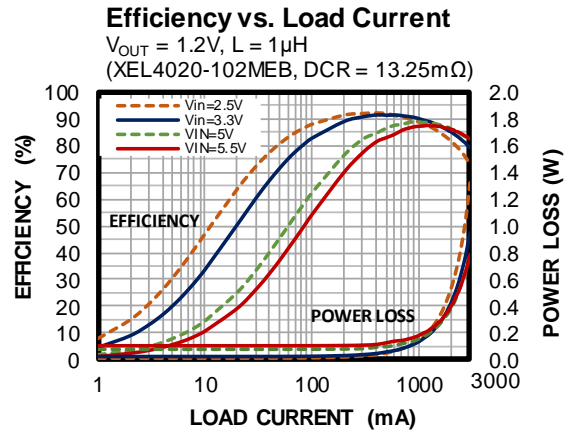
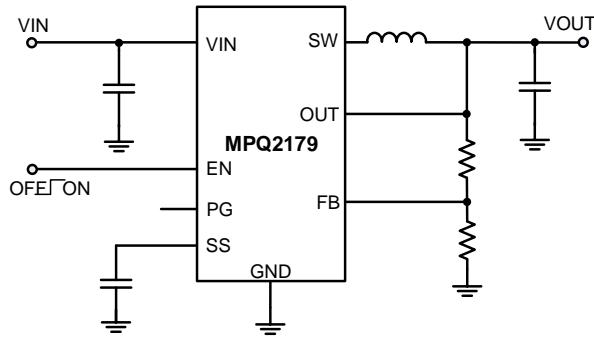

ORDERING INFORMATION

| Part Number* | Package | Top Marking | MSL Rating** |
|---------------------|-------------------|-------------|--------------|
| MPQ2179GQHE*** | QFN-8 (1.5mmx2mm) | See Below | 1 |
| MPQ2179GQHE-AEC1*** | | | |

* For Tape & Reel, add suffix -Z (e.g. MPQ2179GQHE-Z).

** Moisture Sensitivity Level Rating

*** Wettable flank

TOP MARKING

—
KJ

LL

KJ: Product code of MPQ2179GQHE-AEC1 & MPQ2179GQHE

LL: Lot number

PACKAGE REFERENCE

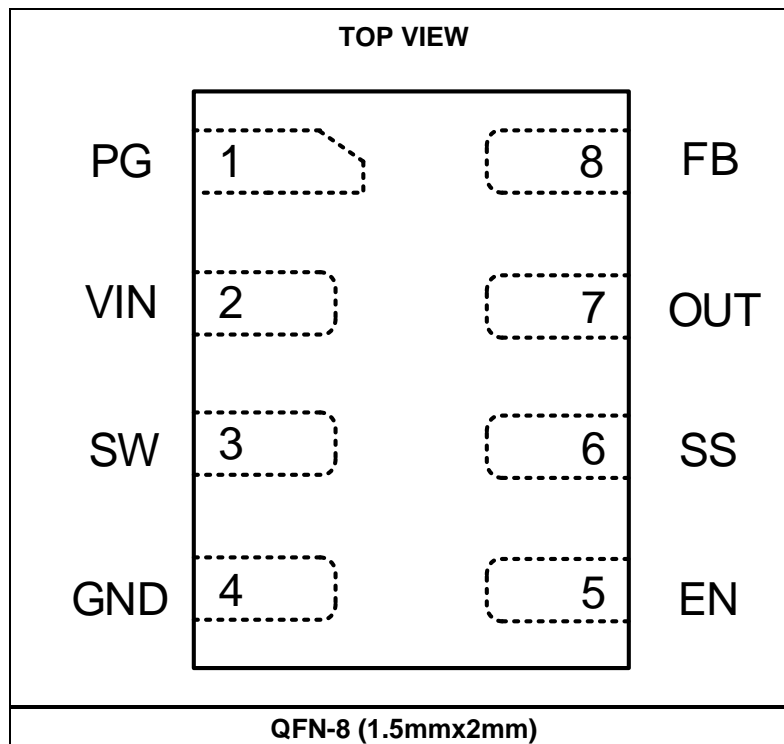

PIN FUNCTIONS

| Pin # | Name | Description |
|-------|------|---|
| 1 | PG | Power good indicator. The output of this pin is an open drain. Connect PG to a voltage source using an external resistor. PG is pulled high when V_{FB} exceeds 90% of V_{REF} ; PG is pulled low to GND if V_{FB} drops below 85% of V_{REF} . Float the pin if it is not used. |
| 2 | VIN | Supply voltage. The MPQ2179 operates from a 2.5V to 5.5V input. Use a decoupling capacitor to prevent large voltage spikes from appearing at the input. |
| 3 | SW | Output switching node. SW is the drain of the internal P-channel MOSFET, which is also called the high-side MOSFET (HS-FET). Connect an inductor to SW to complete the converter. |
| 4 | GND | Ground. |
| 5 | EN | On/off control. Pull EN below the falling threshold (0.4V) to shut down the chip. Pull EN above the rising threshold (1.2V) to enable the chip. There is an internal 2M Ω resistor connected from the EN pin to ground. |
| 6 | SS | Soft start. Connect a capacitor from SS to GND to set the soft-stat time and avoid start-up inrush current. The SS capacitor is recommended to be at least 1nF. |
| 7 | OUT | Output voltage. Power rail and input sense pin for the output voltage. Connect the load to this pin. Use an output capacitor to reduce the output voltage ripple. |
| 8 | FB | Feedback pin. An external resistor divider should be connected from the output to GND, and tapped to the FB pin. The voltage on FB is compared to the internal 0.6V reference to set the regulation voltage. |

ABSOLUTE MAXIMUM RATINGS ⁽¹⁾

| | |
|--|-----------------|
| All pins | -0.3V to +6.5V |
| Junction temperature | 150°C |
| Lead temperature | 260°C |
| Continuous power dissipation ($T_A = 25^\circ\text{C}$) ⁽²⁾ ⁽⁴⁾ | 2.2W |
| Storage temperature | -65°C to +150°C |

ESD Ratings

| | |
|----------------------------------|--------------------|
| Human body model (HBM) | $\pm 2000\text{V}$ |
| Charged device model (CDM) | $\pm 750\text{V}$ |

Recommended Operating Conditions

| | |
|--|--------------------------------|
| Supply voltage (V_{IN}) | 2.5V to 5.5V |
| Output voltage (V_{OUT}) | 0.6V to $V_{IN} - 0.5\text{V}$ |
| Operating junction temp (T_J) | -40°C to +150°C |

Thermal Resistance

| | θ_{JA} | θ_{JC} |
|-------------------------------------|---------------|---------------|
| QFN-8 (1.5mmx2mm) | | |
| JESD51-7 ⁽³⁾ | 130..... | 25..... °C/W |
| EVQ2179-LE-00A ⁽⁴⁾ | 59..... | 14..... °C/W |

Notes:

- Exceeding these ratings may damage the device.
- The maximum allowable power dissipation is a function of the maximum junction temperature, T_J (MAX), the junction-to-ambient thermal resistance, θ_{JA} , and the ambient temperature, T_A . The maximum allowable continuous power dissipation at any ambient temperature is calculated by P_D (MAX) = $(T_J$ (MAX) - T_A) / θ_{JA} . Exceeding the maximum allowable power dissipation can cause excessive die temperature, and the regulator may go into thermal shutdown. Internal thermal shutdown circuitry protects the device from permanent damage.
- Measured on JESD51-7, 4-layer PCB. The values given in this table are only valid for comparison with other packages and cannot be used for design purposes. These values were calculated in accordance with JESD51-7, and simulated on a specified JEDEC board. They do not represent the performance obtained in an actual application.
- Measured on EVQ2179-LE-00A, 4-layer PCB, 2oz each layer, 6.3cmx6.3cm.

ELECTRICAL CHARACTERISTICS

$V_{IN} = 3.6V$, $T_J = -40^{\circ}C$ to $+150^{\circ}C$, typical value is tested at $T_J = 25^{\circ}C$, unless otherwise noted.

| Parameter | Symbol | Condition | Min | Typ | Max | Units |
|--|----------------|--|------|------|------|------------|
| V_{IN} range | | | 2.5 | | 5.5 | V |
| Under-voltage lockout rising threshold | | | | 2.3 | 2.45 | V |
| Under-voltage lockout threshold hysteresis | | | | 200 | | mV |
| Shutdown supply current | | $V_{EN} = 0V$, $T_J = 25^{\circ}C$ | | 0.01 | 1 | μA |
| | | $V_{EN} = 0V$, $T_J = -40^{\circ}C$ to $+125^{\circ}C$ ⁽⁶⁾ | | | 3 | μA |
| | | $V_{EN} = 0V$, $T_J = -40^{\circ}C$ to $+150^{\circ}C$ | | | 20 | μA |
| Quiescent supply current | | $V_{EN} = 2V$, $V_{FB} = 0.63V$, $V_{IN} = 3.6V$ | | 460 | 650 | μA |
| Feedback voltage | V_{FB} | $T_J = 25^{\circ}C$ | 594 | 600 | 606 | mV |
| | | $T_J = -40^{\circ}C$ to $+150^{\circ}C$ | 591 | 600 | 609 | |
| Feedback current | I_{FB} | $V_{FB} = 0.63V$ | | 50 | 100 | nA |
| P-channel MOSFET switch on resistance | $R_{DS(ON)_P}$ | $V_{IN} = 5V$ | | 65 | 85 | m Ω |
| N-channel MOSFET switch on resistance | $R_{DS(ON)_N}$ | $V_{IN} = 5V$ | | 35 | 55 | m Ω |
| Switch leakage | | $V_{EN} = 0V$, $V_{IN} = 6V$ $V_{SW} = 0V$ or $6V$, $T_J = 25^{\circ}C$ | | 0 | 1 | μA |
| | | $V_{EN} = 0V$, $V_{IN} = 6V$ $V_{SW} = 0V$ or $6V$, $T_J = -40^{\circ}C$ to $+125^{\circ}C$ ⁽⁶⁾ | | | 30 | μA |
| Switching frequency | f_{SW} | $V_{IN} = 5V$, $V_{OUT} = 1.2V$, operating under CCM. | 2000 | 2400 | 2640 | kHz |
| Minimum on time ⁽⁶⁾ | t_{MIN-ON} | $V_{IN} = 5V$ | | 50 | | ns |
| Minimum off time ⁽⁶⁾ | $t_{MIN-OFF}$ | $V_{IN} = 5V$ | | 80 | | ns |
| P-channel MOSFET peak current limit | | | 4 | 5 | 6 | A |
| N-channel MOSFET valley current limit | | | 1.5 | 3 | 4.5 | A |
| Soft-start current | I_{SS_ON} | | 1.5 | 3 | 4.5 | μA |
| Maximum duty cycle | | | | 100 | | % |
| Power good UV rising threshold | | FB rising edge | 87 | 90 | 93 | % |
| Power good UV falling threshold | | FB falling edge | 82 | 85 | 88 | % |
| Power good delay | t_{PGD} | PG rising/falling edge | | 80 | | μs |
| Power good sink current capability | V_{PG-L} | Sink 1mA | | | 0.4 | V |
| Power good logic high voltage | V_{PG-H} | $V_{IN} = 5V$, $V_{FB} = 0.6V$ | 4.9 | | | V |
| Self-bias PG ⁽⁵⁾ | | | | | 0.7 | V |

ELECTRICAL CHARACTERISTICS (continued)
 $V_{IN} = 3.6V$, $T_J = -40^{\circ}C$ to $+150^{\circ}C$, typical value is tested at $T_J = 25^{\circ}C$, unless otherwise noted.

| Parameter | Symbol | Condition | Min | Typ | Max | Units |
|--|----------------|----------------------------------|------|------|------|-------------|
| Power good leakage current/logic high | | 5V logic high | | | 100 | nA |
| EN turn-on delay | | EN on to SW active | | 100 | | us |
| EN turn-off delay | | EN off to stop switching | | 30 | | us |
| EN input logic low voltage | | | | | 0.4 | V |
| EN input logic high voltage | | | 1.2 | | | V |
| EN pull-down resistor | | | | 2 | | M Ω |
| Output discharge resistor | R_{DIS} | $V_{EN} = 0V$, $V_{OUT} = 1.2V$ | | 150 | | Ω |
| EN input current | | $V_{EN} = 2V$ | | 1.2 | | μA |
| | | $V_{EN} = 0V$ | | 0 | | μA |
| Output over-voltage rising threshold | V_{OVP} | | 110% | 115% | 120% | V_{FB} |
| Output over-voltage hysteresis | V_{OVP_HYS} | | | 10% | | V_{FB} |
| Output over-voltage delay | | | | 2 | | us |
| Low-side current limit | | Current flow from SW to GND | | 1.2 | | A |
| Absolute VIN OVP | | After V_{OUT} OVP enable | | 6.1 | | V |
| Absolute VIN OVP hysteresis | | | | 160 | | mV |
| Thermal shutdown ⁽⁶⁾ | | | | 170 | | $^{\circ}C$ |
| Thermal shutdown hysteresis ⁽⁶⁾ | | | | 20 | | $^{\circ}C$ |

Notes:

- 5) If $V_{IN} = 0V$ and $EN=0V$, PG should be pulled up between 3.0V and 5.5V with a 100k Ω resistor.
6) Guaranteed by design and bench characterization, not tested in production.

TYPICAL CHARACTERISTICS

$V_{IN} = 3.6V$, $T_J = -40^{\circ}C$ to $+150^{\circ}C$, unless otherwise noted.

V_{IN} UVLO Threshold vs. Temperature

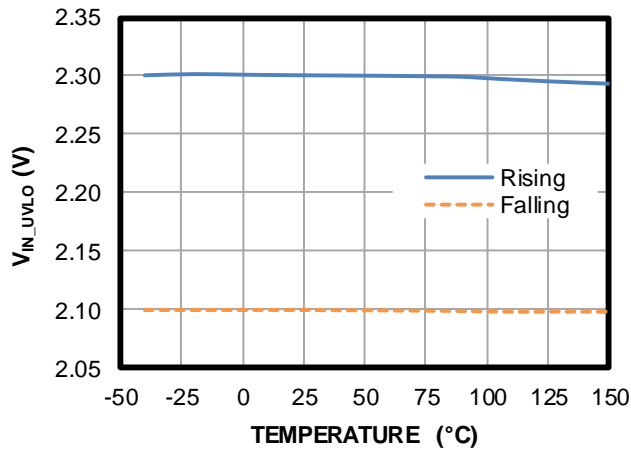

EN Rising and Falling Threshold vs. Temperature

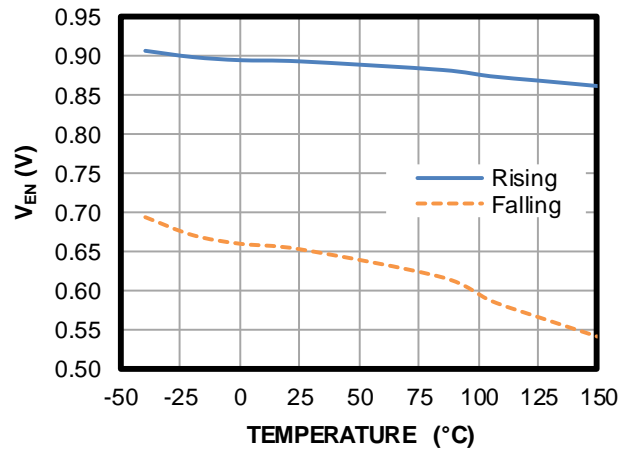

Shutdown Current vs. Temperature

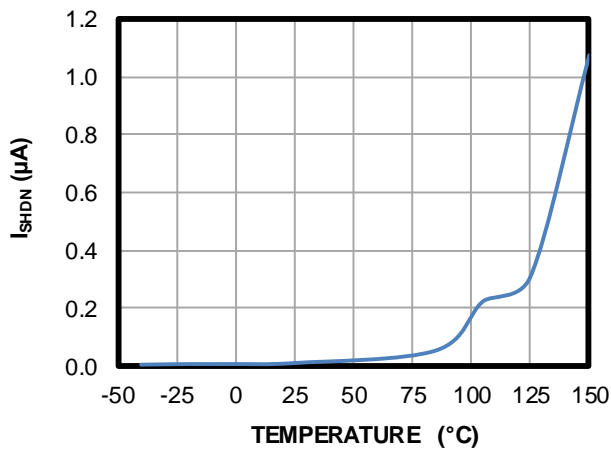

Quiescent Current vs. Temperature

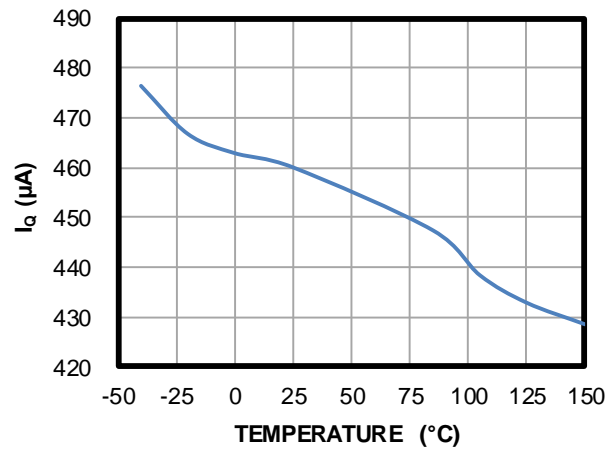

V_{FB} vs. Temperature

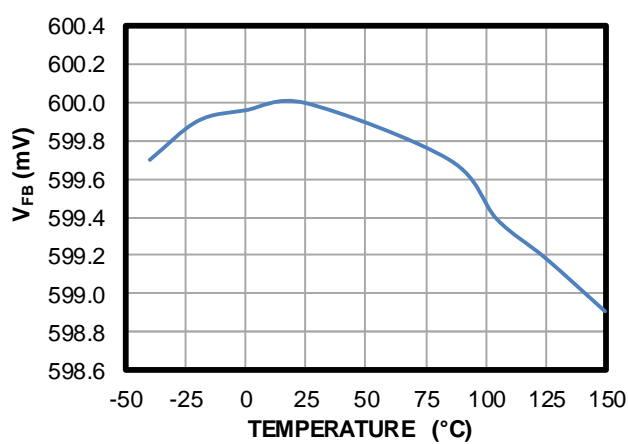

f_{SW} vs. Temperature

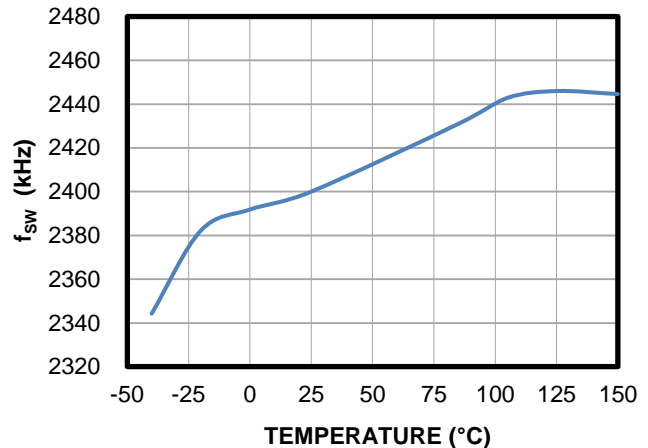

TYPICAL CHARACTERISTICS (continued)
 $V_{IN} = 3.6V$, $T_J = -40^{\circ}C$ to $+150^{\circ}C$, unless otherwise noted.

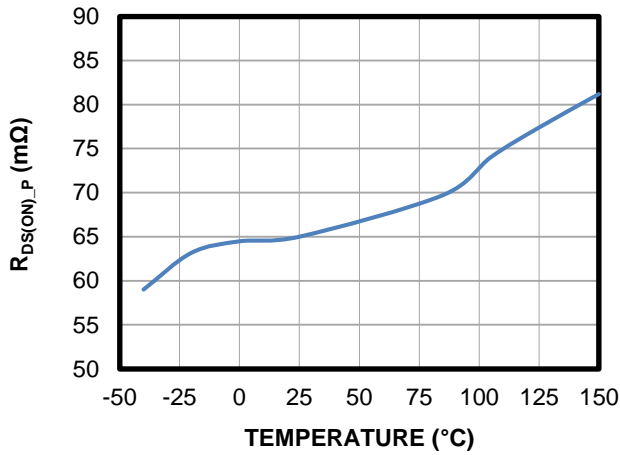
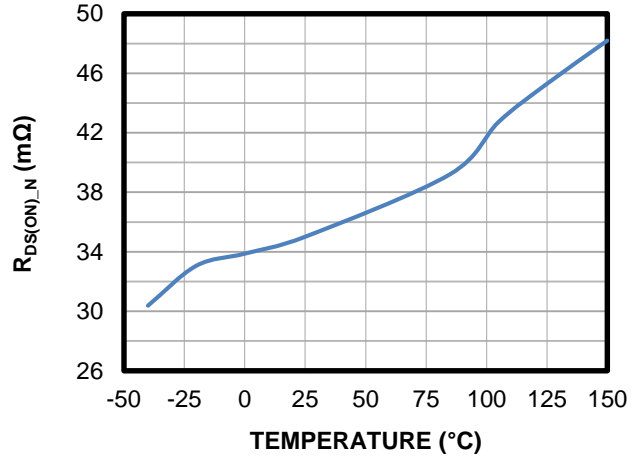
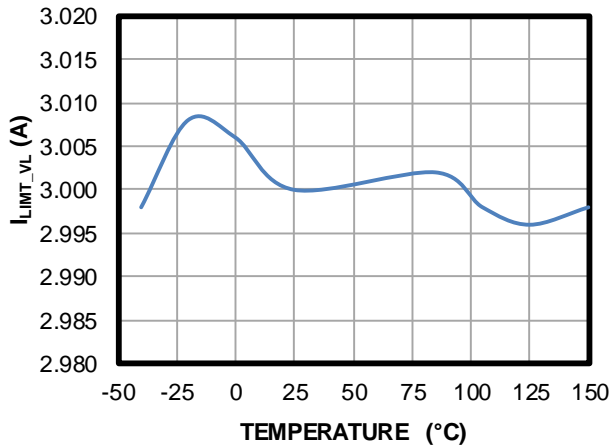
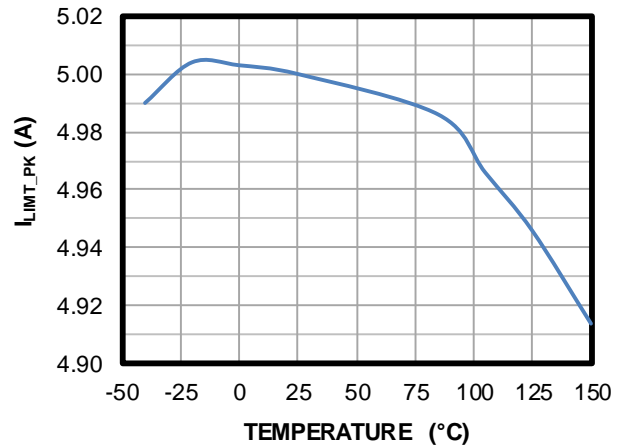
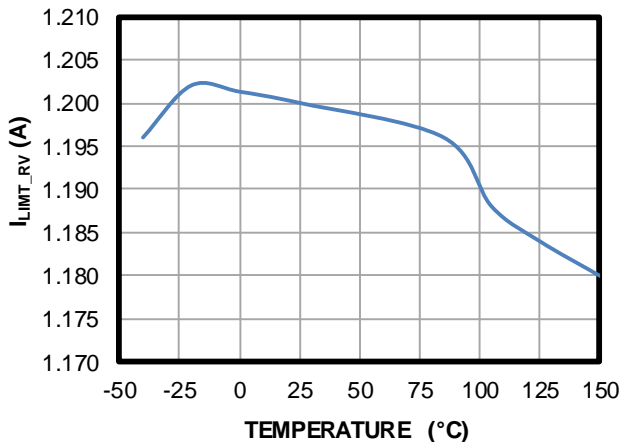
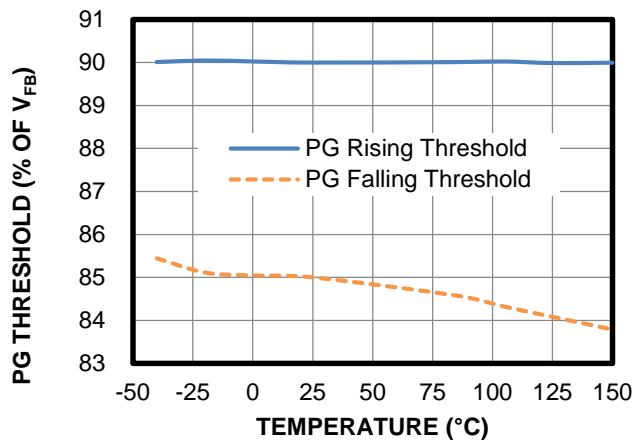
 $R_{DS(ON)_P}$ vs. Temperature

 $R_{DS(ON)_N}$ vs. Temperature

LS-FET Valley Current Limit vs. Temperature

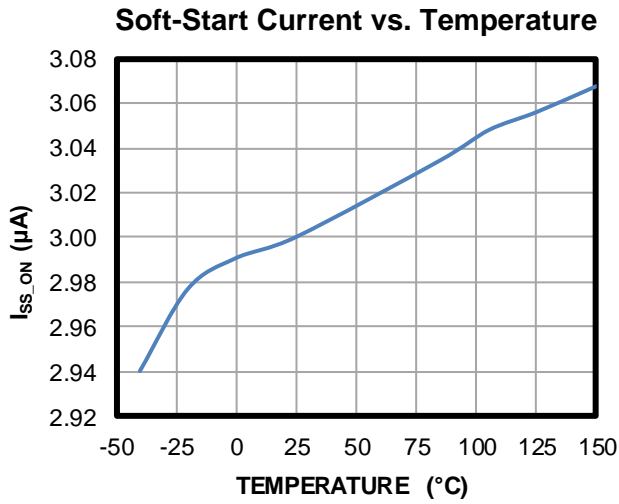
HS-FET Peak Current Limit vs. Temperature

Low-Side Reverse Current Limit vs. Temperature

PG Rising/Falling Threshold vs. Temperature

TYPICAL CHARACTERISTICS *(continued)*

$V_{IN} = 3.6V$, $T_J = -40^{\circ}C$ to $+150^{\circ}C$, unless otherwise noted.



TYPICAL PERFORMANCE CHARACTERISTICS

$V_{IN} = 3.3V$, $V_{OUT} = 1.2V$, $L = 1\mu H$, $C_{OUT} = 22\mu F$, $T_A = 25^\circ C$, unless otherwise noted.

Efficiency vs. Load Current (Light Load)

$V_{OUT} = 1.2V$, $L = 1\mu H$
(XEL4020-102MEB, DCR = 13.25m Ω)

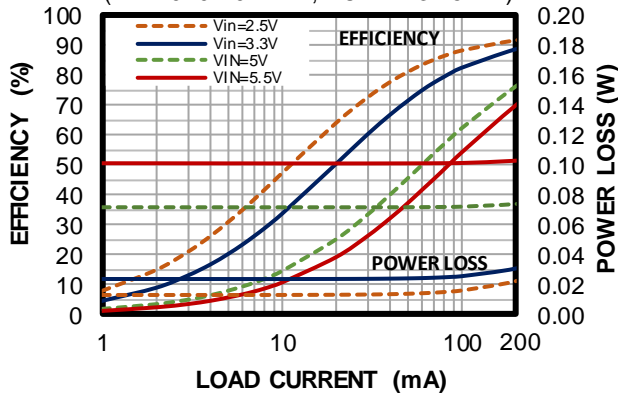

Efficiency vs. Load Current

$V_{OUT} = 1.2V$, $L = 1\mu H$
(XEL4020-102MEB, DCR = 13.25m Ω)

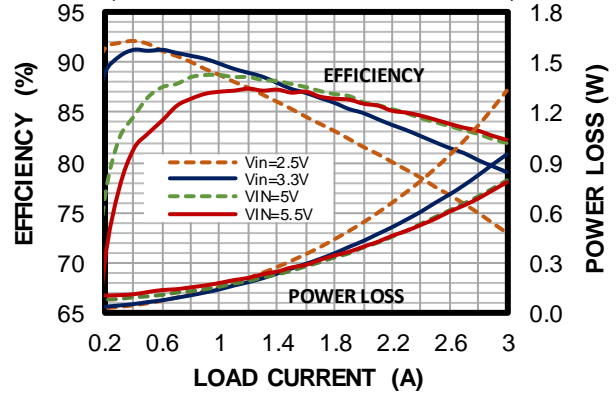

Efficiency vs. Load Current (Light Load)

$V_{OUT} = 1.8V$, $L = 1\mu H$
(XEL4020-102MEB, DCR = 13.25m Ω)

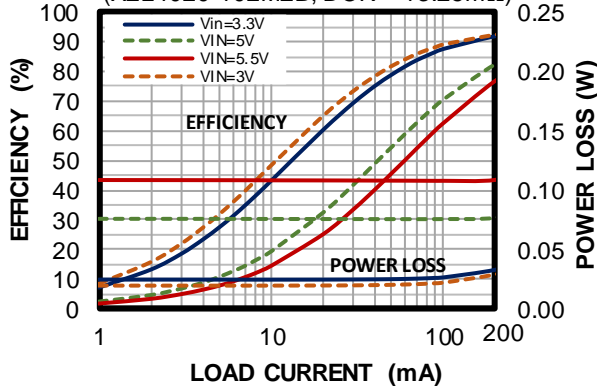

Efficiency vs. Load Current

$V_{OUT} = 1.8V$, $L = 1\mu H$
(XEL4020-102MEB, DCR = 13.25m Ω)

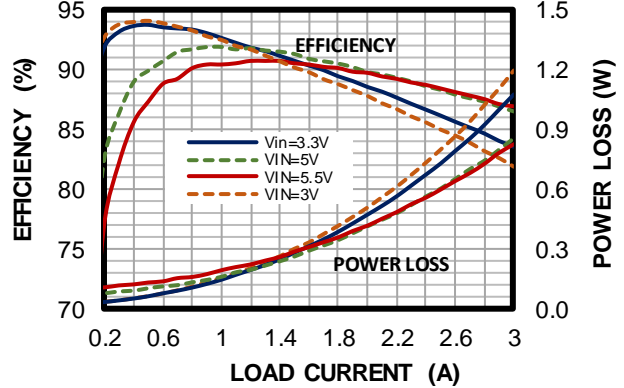

Case Thermal Rise

$V_{OUT} = 1.2V$

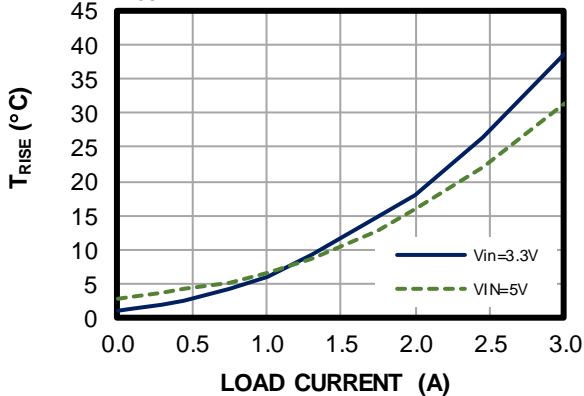

Case Thermal Rise

$V_{OUT} = 1.8V$

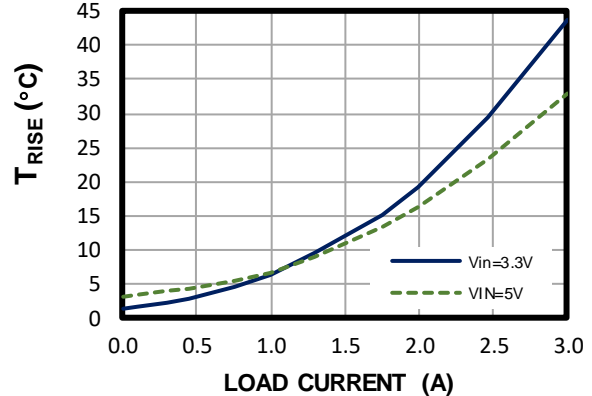

TYPICAL PERFORMANCE CHARACTERISTICS *(continued)*

$V_{IN} = 3.3V$, $V_{OUT} = 1.2V$, $L = 1\mu H$, $C_{OUT} = 22\mu F$, $T_A = 25^\circ C$, unless otherwise noted.

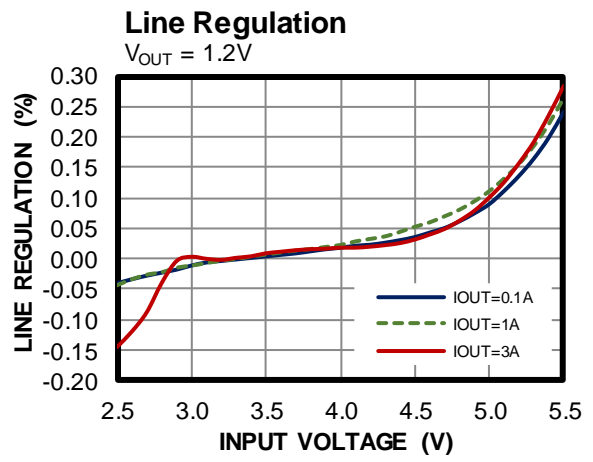
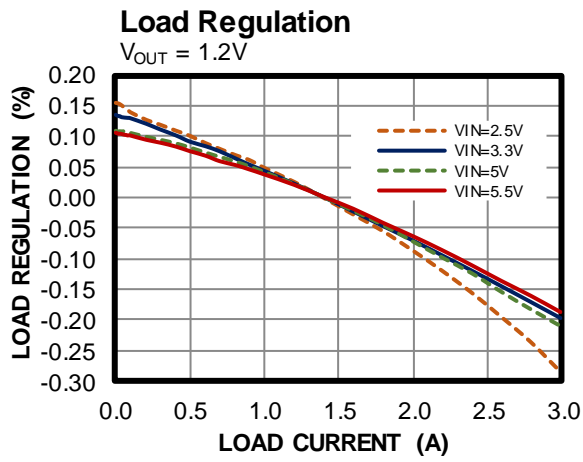

TYPICAL PERFORMANCE CHARACTERISTICS (continued)

$V_{IN} = 3.3V$, $V_{OUT} = 1.2V$, $L = 1\mu H$, $C_{OUT} = 22\mu F$, $T_A = 25^\circ C$, unless otherwise noted.

Steady State

$I_{OUT} = 0A$

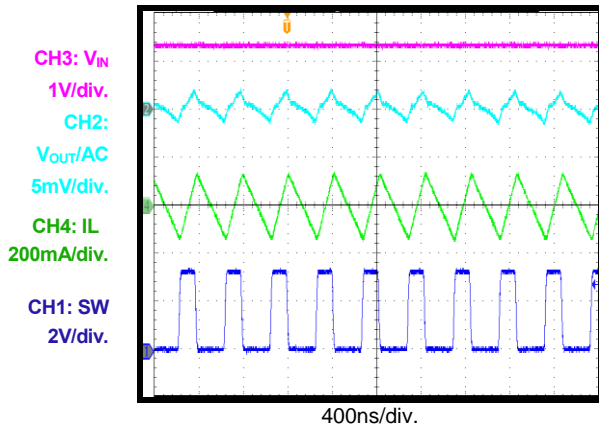

Steady State

$I_{OUT} = 3A$

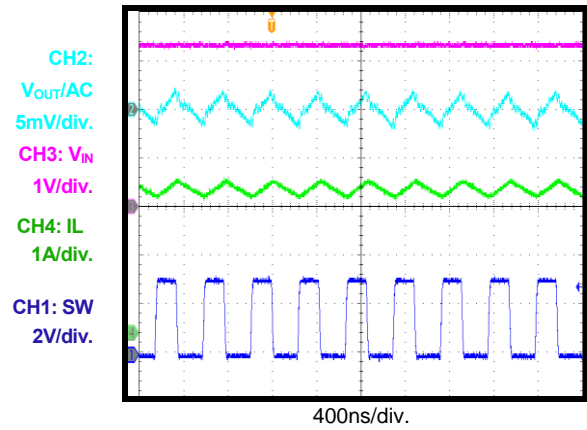

Start-Up through VIN

$I_{OUT} = 0A$

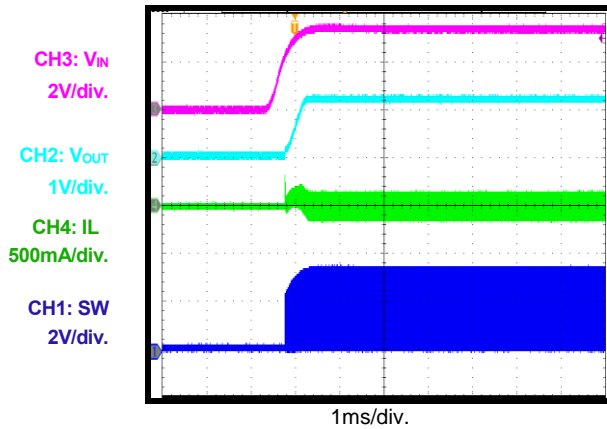

Start-Up through VIN

$I_{OUT} = 3A$

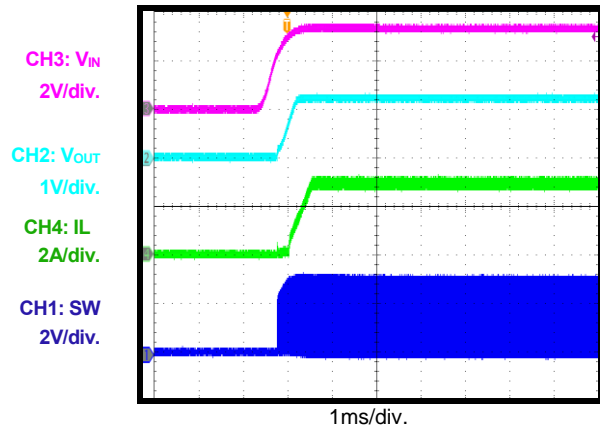

Shutdown through VIN

$I_{OUT} = 0A$

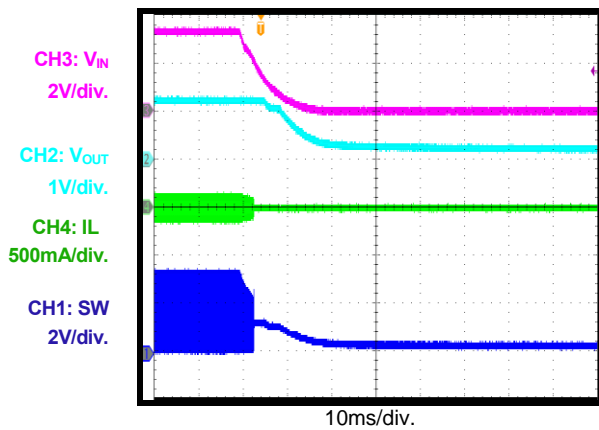

Shutdown through VIN

$I_{OUT} = 3A$

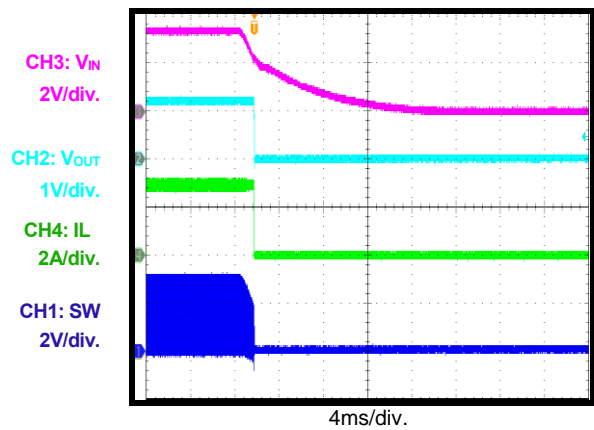

TYPICAL PERFORMANCE CHARACTERISTICS (continued)
 $V_{IN} = 3.3V$, $V_{OUT} = 1.2V$, $L = 1\mu H$, $C_{OUT} = 22\mu F$, $T_A = 25^\circ C$, unless otherwise noted.

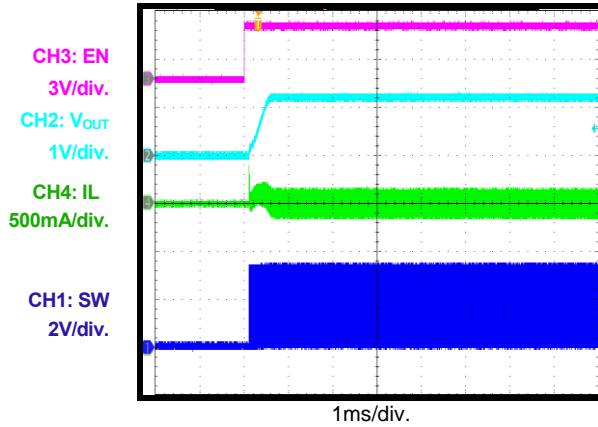
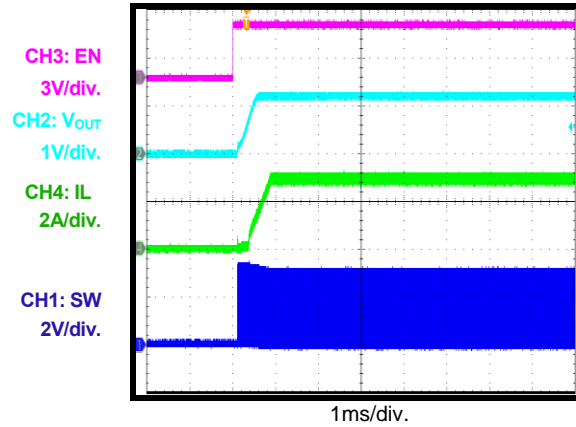
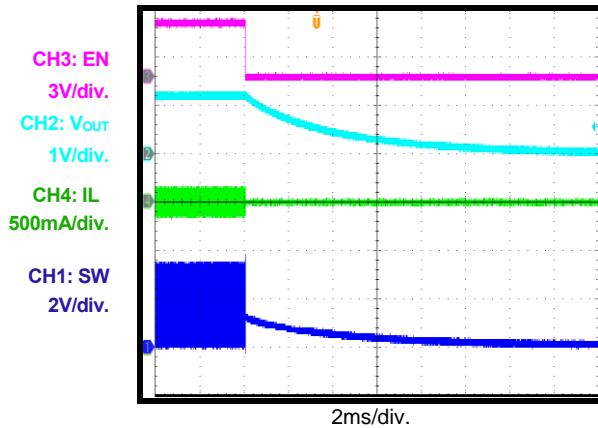
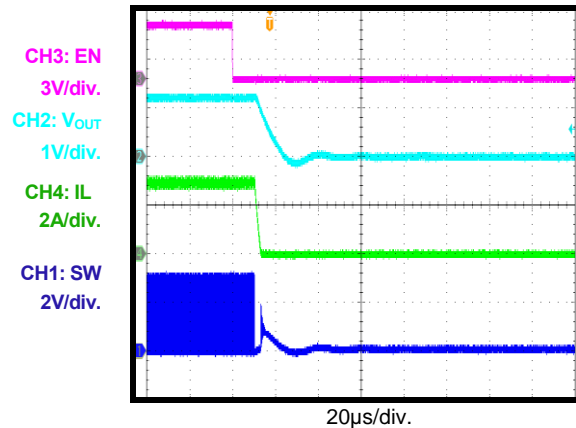
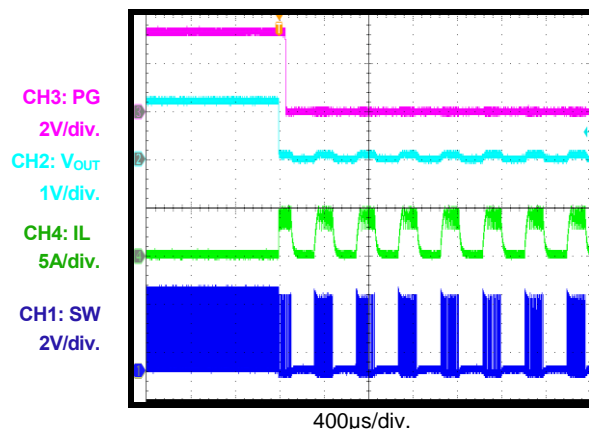
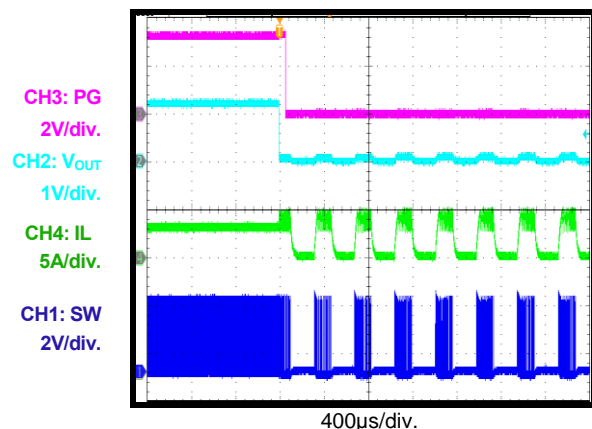
Start-Up through EN
 $I_{OUT} = 0A$

Start-Up through EN
 $I_{OUT} = 3A$

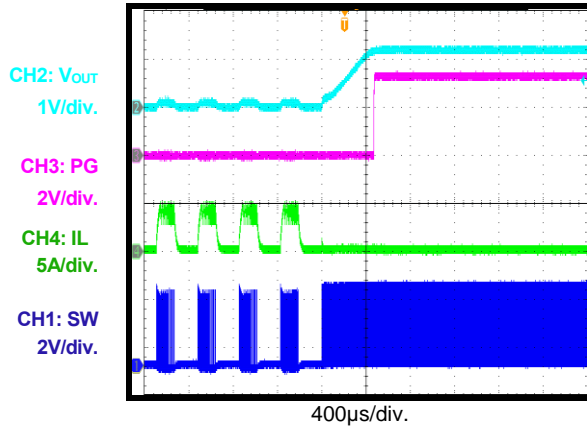
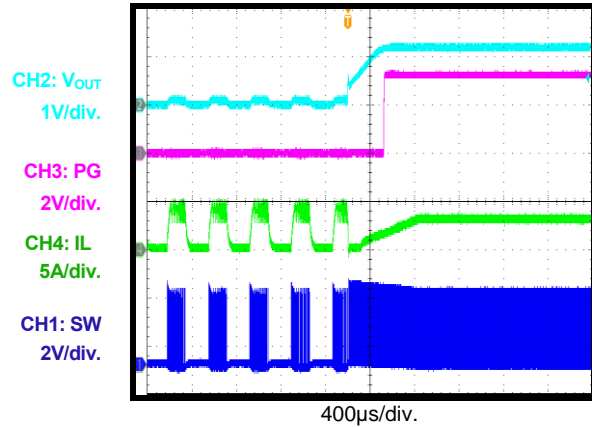
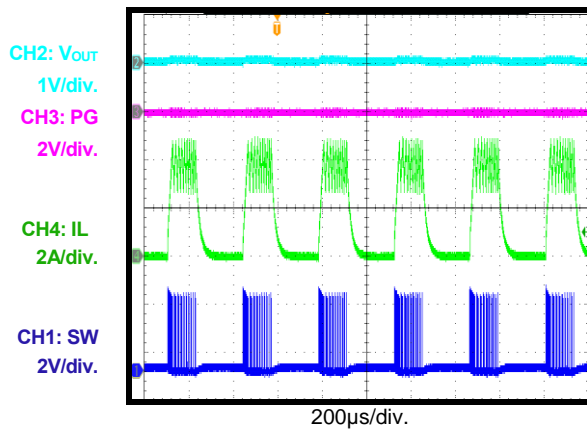
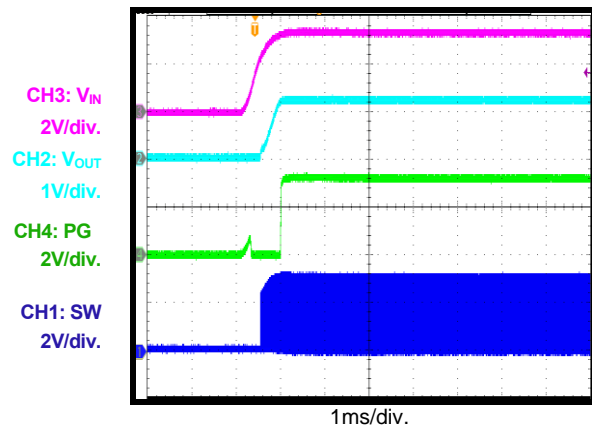
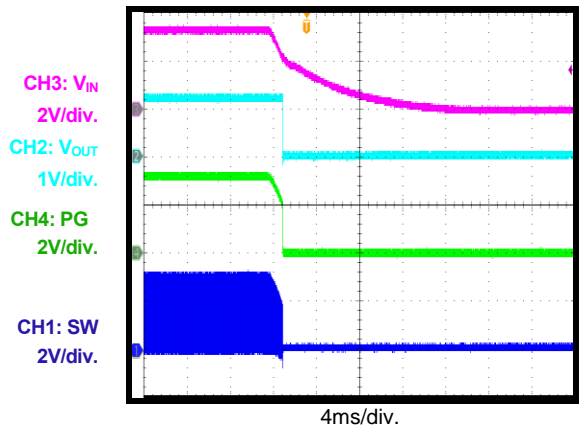
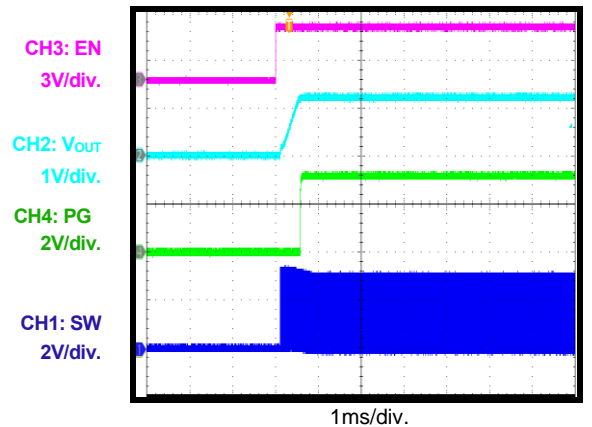
Shutdown through EN
 $I_{OUT} = 0A$

Shutdown through EN
 $I_{OUT} = 3A$

SCP Entry
 $I_{OUT} = 0A$

SCP Entry
 $I_{OUT} = 3A$

TYPICAL PERFORMANCE CHARACTERISTICS (continued)
 $V_{IN} = 3.3V$, $V_{OUT} = 1.2V$, $L = 1\mu H$, $C_{OUT} = 22\mu F$, $T_A = 25^\circ C$, unless otherwise noted.

SCP Recovery
 $I_{OUT} = 0A$

SCP Recovery
 $I_{OUT} = 3A$

Short Circuit

PG Start-Up through VIN
 $I_{OUT} = 3A$

PG Shutdown through VIN
 $I_{OUT} = 3A$

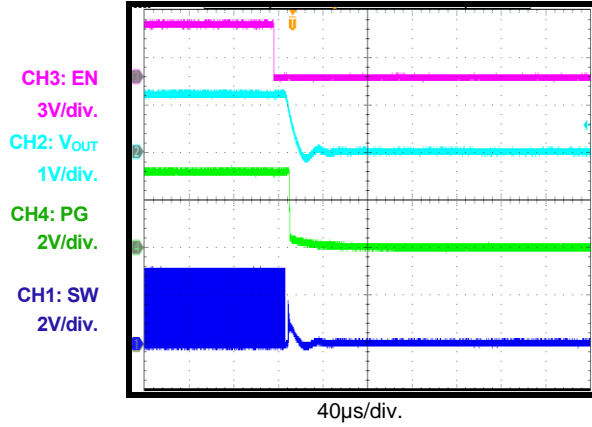
PG Start-Up through EN
 $I_{OUT} = 3A$

TYPICAL PERFORMANCE CHARACTERISTICS *(continued)*

$V_{IN} = 3.3V$, $V_{OUT} = 1.2V$, $L = 1\mu H$, $C_{OUT} = 22\mu F$, $T_A = 25^\circ C$, unless otherwise noted.

PG Shutdown through EN

$I_{OUT} = 3A$



Load Transient

$I_{OUT} = 1.5$ to $3A$, $1A/\mu s$

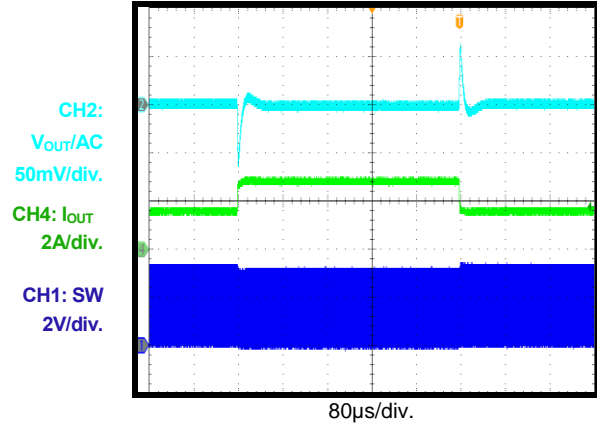

FUNCTIONAL BLOCK DIAGRAM

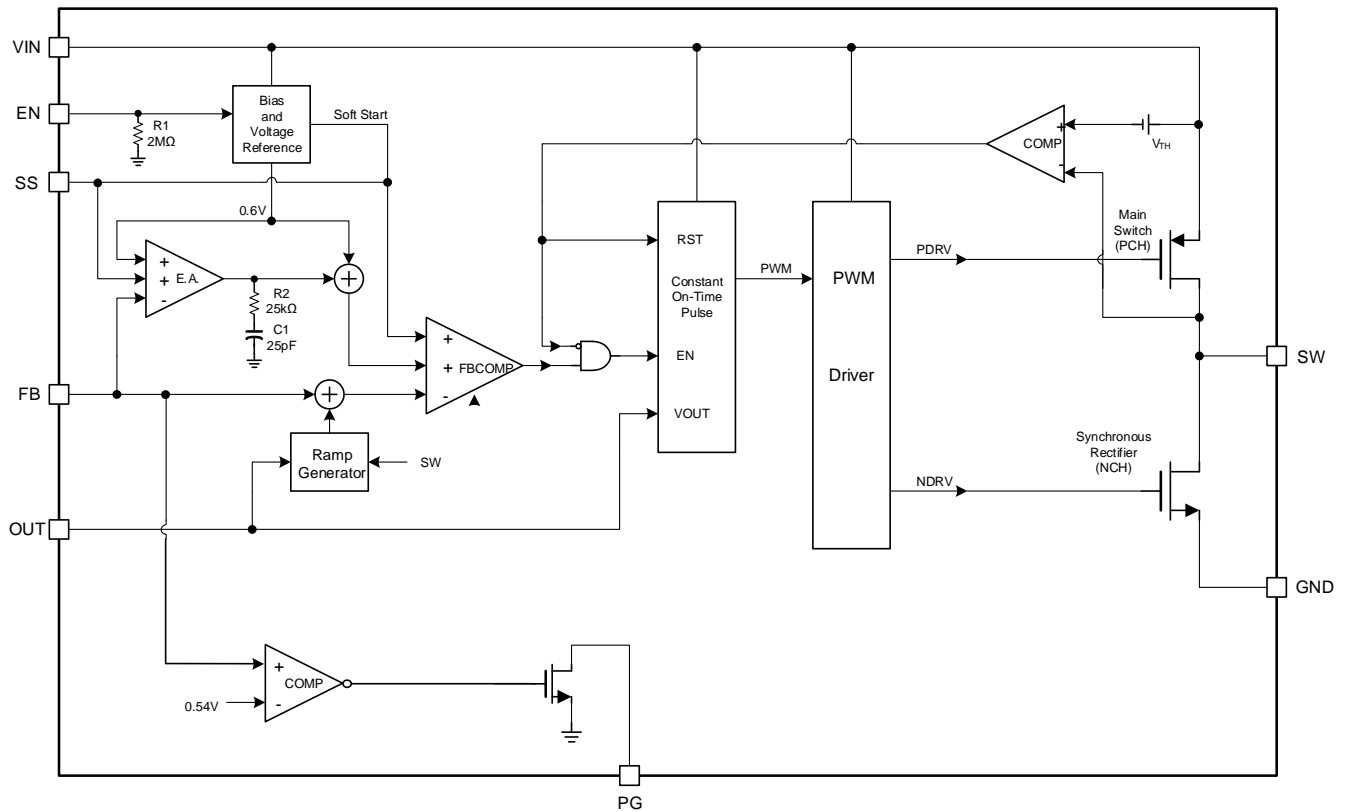

Figure 1: Functional Block Diagram

OPERATION

The MPQ2179 uses constant-on-time (COT) control with input voltage feed-forward to stabilize the switching frequency across the full input voltage range. The device achieves 3A of peak output current from a 2.5V to 5.5V input voltage range, with excellent load and line regulation. The output voltage can be regulated to as low as 0.6V. A 100% maximum duty cycle can be reached in dropout.

Constant-On-Time (COT) Control

Compared to fixed frequency PWM control, constant on-time (COT) control offers a simpler control loop and faster transient response. To prevent inductor current runaway during load transient, the MPQ2179 switching cycles have a fixed minimum off time. When the low-side MOSFET (LS-FET) turns on, it remains on for at least as long as $t_{\text{MIN-OFF}}$. Then the high-side MOSFET (HS-FET) turns on when the feedback voltage (V_{FB}) drops below the reference voltage (V_{REF}). This indicates an insufficient output voltage. By using input voltage feed-forward, the MPQ2179 maintains a nearly constant switching frequency across the input and load ranges. The switching pulse on time can be calculated with Equation (1):

$$t_{\text{ON}} = \frac{V_{\text{OUT}}}{V_{\text{IN}}} \times 400\text{ns} \quad (1)$$

To improve frequency stability and reduce the output voltage ripple, the part operates in forced continuous conduction mode (FCCM).

Enable (EN)

EN is a digital control pin that can turn the regulator on and off. When EN is pulled below the falling threshold voltage (0.4V), the chip shuts down. Force EN above its rising threshold voltage (1.2V) to turn the part on. Leave EN floating or pull it down to ground to disable the MPQ2179. There is an internal 2M Ω resistor connected from the EN pin to ground.

When the device is disabled, the part automatically goes into output discharge mode, and its internal discharge MOSFET provides a resistive discharge path for the output capacitor.

Soft Start (SS)

The MPQ2179 has an external soft start (SS) pin that ramps up the output voltage at a controlled slew rate to avoid overshoot at start-up. The SS pin's charge current is typically 3 μ A.

The soft-start time (t_{SS}) is determined by the SS capacitor. t_{SS} can be calculated with Equation (2):

$$t_{\text{SS}}(\text{ms}) = \frac{C_{\text{SS}}(\text{nF}) \times 0.6\text{V}}{I_{\text{SS}}(\mu\text{A})} \quad (2)$$

Where C_{SS} is the external SS capacitor, and I_{SS} is the internal 3 μ A SS charge current. The minimum SS capacitor is recommended to be 1nF.

Peak and Valley Current Limit

Both the P-channel MOSFET (also called the HS-FET) and N-channel MOSFET (also called the LS-FET) have current limit protection. When the inductor current (I_{L}) reaches the HS-FET peak current limit (typically 5A) during the HS-FET on period, the HS-FET is forced off immediately to prevent the current from rising further. Then the LS-FET turns on, and stays on until I_{L} drops below the LS-FET valley current limit (typically 3.5A). The HS-FET turns on once I_{L} has dropped to a sufficiently low threshold. The MPQ2179 remains in hiccup mode until the current drops. This current limit scheme prevents current runaway in overload and short-circuit events.

Short-Circuit Protection (SCP) and Recovery

If the output is shorted to ground, the MPQ2179 initiates short-circuit protection (SCP) when the inductor current reaches the current limit. The device tries to recover with hiccup mode. The IC disables the output power stage and begins discharging the SS voltage. The device restarts with a full soft-start once the SS voltage is fully discharged. This hiccup process is repeated until the fault is removed.

Output Over-Voltage Protection (V_{OUT} OVP)

The MPQ2179 monitors a resistor-divided feedback voltage to detect over-voltage (OV) conditions. If the feedback voltage (V_{FB}) rises above 115% of the reference voltage (V_{REF}), the controller enters a dynamic regulation period.

During this period, the LS-FET stays until the LS-FET current drops to -1.2A. This discharges the output and tries to keep the output voltage within the normal range.

If the OV condition still exists after this process, the LS-FET turns on after an 1.5 μ s time delay. The device exits this regulation period when feedback voltage drops below 105% of the reference voltage. If dynamic regulation cannot limit V_{OUT} , and the input detect a 6.1V input voltage, input OVP occurs. Then the MPQ2179 stops switching, and does not resume normal operation until the input voltage drops below 6V.

Power Good Indicator

The MPQ2179 has one power good (PG) output to indicate normal operation after the soft-start time. PG is the open drain of an internal MOSFET, which has a maximum $R_{DS(ON)}$ below 400 Ω . PG can be connected to VIN or an external voltage source through an external a resistor (e.g. 100k Ω).

After the input voltage is applied, the MOSFET turns on, and PG is pulled to GND before soft start is ready. After V_{FB} reaches 90% of V_{REF} , PG is pulled high by the external voltage source. When V_{FB} drops to 85% of V_{REF} , the PG voltage is pulled to GND to indicate an output failure.

If VIN and EN are not available, and PG is pulled up by an external power supply, PG will self-bias and assert. If a 100k Ω pull-up resistor is used, the voltage on the pin is below 0.7V.

APPLICATION INFORMATION

Setting the Output Voltage

The external resistor divider sets the output voltage. Select a feedback resistor (R1) that reduces the V_{OUT} leakage current. Generally, it is recommended for R1 to be between 10k Ω and 100k Ω . R2 can then be calculated with Equation (3):

$$R2 = \frac{R1}{\frac{V_{OUT}}{0.6} - 1} \quad (3)$$

Figure 2 shows the feedback circuit.

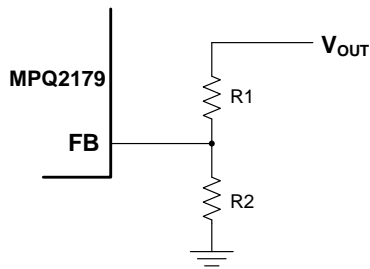

Figure 2: Feedback Network

Table 1 lists the recommended resistors value for common output voltages.

Table 1: Resistor Values for Common Output Voltages

| V_{OUT} (V) | R1 (k Ω) | R2 (k Ω) |
|---------------|------------------|------------------|
| 1.0 | 30.9 (1%) | 47 (1%) |
| 1.2 | 100 (1%) | 100 (1%) |
| 1.8 | 36 (1%) | 18 (1%) |
| 2.5 | 51 (1%) | 16 (1%) |
| 3.3 | 68 (1%) | 15 (1%) |

Frequency Scales Down at Low V_{IN}

At heavy loads, the voltage on the HS-FET drops while t_{ON} increases, and the duty cycle is extended. If the minimum off time is reached when there is a low input voltage under a heavy load, the frequency scales down. To maintain a constant switching frequency, a higher output voltage requires a higher V_{IN} under heavy loads. For a 1.8V output, the input voltage must exceed 3V to keep the frequency above 2MHz for 3A loads.

The input voltage when the frequency starts to scale down can be estimated with Equation (4):

$$V_{IN} = \frac{V_{OUT} + R_{DS(ON)_P} \times I_{OUT}}{1 - \frac{t_{MIN-OFF}}{400 \times 10^{-9}}} \quad (4)$$

Where the maximum $t_{MIN-OFF}$ is 125ns. ⁽⁷⁾

Note:

7) Guaranteed by design and bench characterization. Not tested in production.

Selecting the Inductor

Most applications work best with a 0.47 μ H to 1.5 μ H inductor. Select an inductor with a DC resistance less than 25m Ω to optimize efficiency.

High-frequency, switch-mode power supplies with magnetic devices can have strong electronic magnetic inference. It is not recommended to use an unshielded power inductor, as they do not provide sufficient magnetic shielding. Shield inductors (e.g. metal alloy inductor or multiplayer chip power inductor) are recommended because they effectively reduce magnetic interference.

For most designs, estimate the inductance value can be estimated with Equation (5):

$$L_1 = \frac{V_{OUT} \times (V_{IN} - V_{OUT})}{V_{IN} \times \Delta I_L \times f_{SW}} \quad (5)$$

Where ΔI_L is the inductor ripple current.

Choose an inductor ripple current to be approximately 30% of the maximum load current. The maximum inductor peak current can be calculated with Equation (6):

$$I_{L(MAX)} = I_{LOAD} + \frac{\Delta I_L}{2} \quad (6)$$

Selecting the Input Capacitor

The step-down converter has a discontinuous input current, and requires a capacitor to supply the AC current to the converter while maintaining the DC input voltage. Use low-ESR capacitors for the best performance. Ceramic capacitors with X5R or X7R dielectrics are highly recommended because of their low ESR and small temperature coefficients. For most applications, a 10 μ F capacitor is sufficient. Higher output voltages may require a 22 μ F capacitor to increase system stability.

The input capacitor requires an adequate ripple current rating because it absorbs the input switching current. Estimate the RMS current in the input capacitor with Equation (7):

$$I_{C1} = I_{LOAD} \times \sqrt{\frac{V_{OUT}}{V_{IN}} \times \left(1 - \frac{V_{OUT}}{V_{IN}}\right)} \quad (7)$$

The worst case occurs at $V_{IN} = 2V_{OUT}$, calculated with Equation (8):

$$I_{C1} = \frac{I_{LOAD}}{2} \quad (8)$$

For simplification, choose an input capacitor with an RMS current rating greater than half of the maximum load current.

The input capacitor can be electrolytic, tantalum, or ceramic. When using electrolytic or tantalum capacitors, add a small, high-quality, ceramic 0.1 μ F capacitor as close to the IC as possible. When using ceramic capacitors, ensure that they have enough capacitance to provide sufficient charge to prevent excessive voltage ripple at the input. The input voltage ripple caused by the capacitance can be estimated with Equation (9):

$$\Delta V_{IN} = \frac{I_{LOAD}}{f_{SW} \times C1} \times \frac{V_{OUT}}{V_{IN}} \times \left(1 - \frac{V_{OUT}}{V_{IN}}\right) \quad (9)$$

Selecting the Output Capacitor

The output capacitor (C2) stabilizes the DC output voltage. Ceramic capacitors are recommended, as well as low-ESR capacitors to limit the output voltage ripple. Estimate the output voltage ripple with Equation (10):

$$\Delta V_{OUT} = \frac{V_{OUT}}{f_{SW} \times L_1} \times \left(1 - \frac{V_{OUT}}{V_{IN}}\right) \times \left(R_{ESR} + \frac{1}{8 \times f_s \times C2}\right) \quad (10)$$

Where L_1 is the inductor value and R_{ESR} is the equivalent series resistance (ESR) value of the output capacitor.

When using ceramic capacitors, the capacitance dominates the impedance at the switching frequency, and causes most of the output voltage ripple. For simplification, the output voltage ripple can be estimated with Equation (11):

$$\Delta V_{OUT} = \frac{V_{OUT}}{8 \times f_{SW}^2 \times L_1 \times C2} \times \left(1 - \frac{V_{OUT}}{V_{IN}}\right) \quad (11)$$

Ceramic capacitors with X7R or X5R dielectrics are highly recommended because of their low ESR and small temperature coefficients.

For a 3A load, a 22 μ F capacitor with a 0805 package (or a larger capacitor) is recommended to reduce the output voltage ripple during steady state operation and load transient. To see the detailed output voltage ripple performance, see the Typical Performance Characteristics section on page 10.

The output capacitor value can be smaller for applications with a lower current, or if a larger-value output voltage ripple is allowed. However, to ensure loop stability, the output capacitor should never be below 10 μ F, or smaller than a 1206 package.

For tantalum or electrolytic capacitors, the ESR dominates the impedance at the switching frequency. For simplification, the output ripple can be estimated with Equation (12):

$$\Delta V_{OUT} = \frac{V_{OUT}}{f_{SW} \times L_1} \times \left(1 - \frac{V_{OUT}}{V_{IN}}\right) \times R_{ESR} \quad (12)$$

The characteristics of the output capacitor also affect the stability of the regulation system.

PCB Layout Guidelines

Proper layout of the switching power supplies is important, and sometimes critical for proper function. For the high-frequency switching converter, poor layout design can result in poor line or load regulation, as well as stability issues. For the best results, refer to Figure 3 and follow the guidelines below.

1. Place the high-current paths (GND, VIN, and SW) close to the device with short, direct, and wide traces.
2. Place the input capacitor as close as possible to the VIN and GND pins.
3. The output capacitor for GND must be close to the GND pins.
4. Place the external feedback resistors next to the FB pin.
5. Keep the switching node (SW) short, and route it away from the feedback network.
6. Keep the output voltage sense line as short as possible, and route it away from the power inductor. Do not place this line close to surrounding inductors or SW.

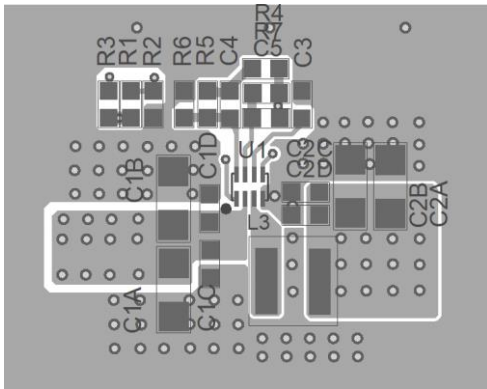

Top Layer

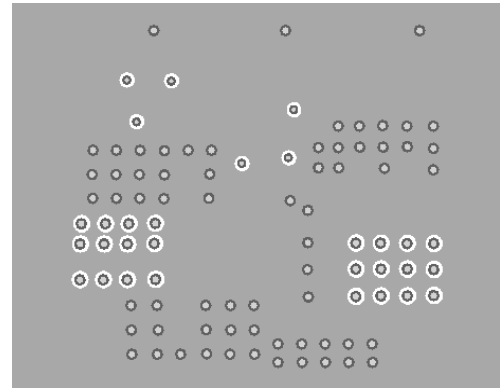

Inner Layer 1

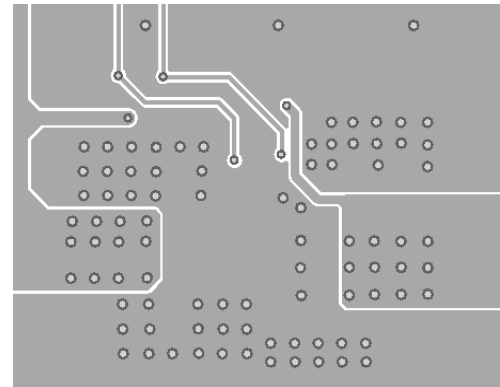

Inner Layer 2

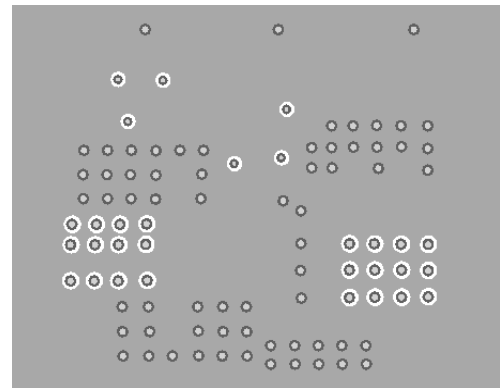

Bottom Layer

Figure 3: Recommended PCB Layout

TYPICAL APPLICATION CIRCUITS

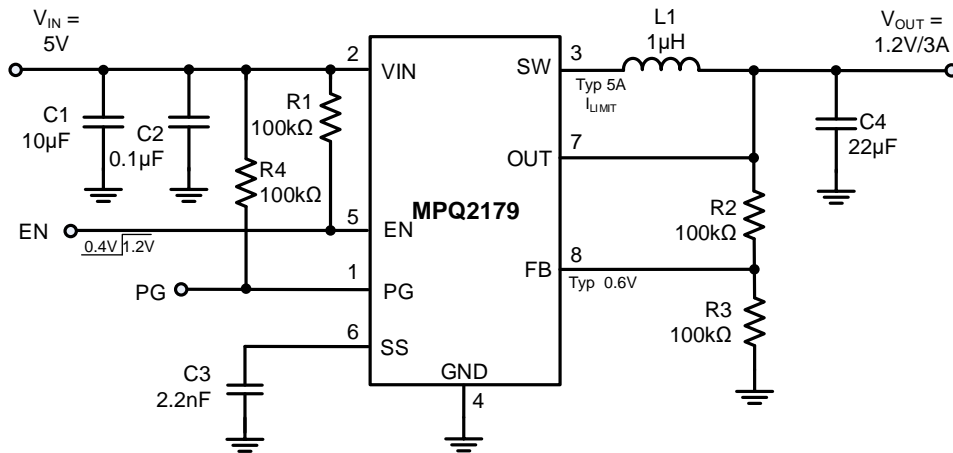

Figure 4: 1.2V Output Application Circuit for the MPQ2179

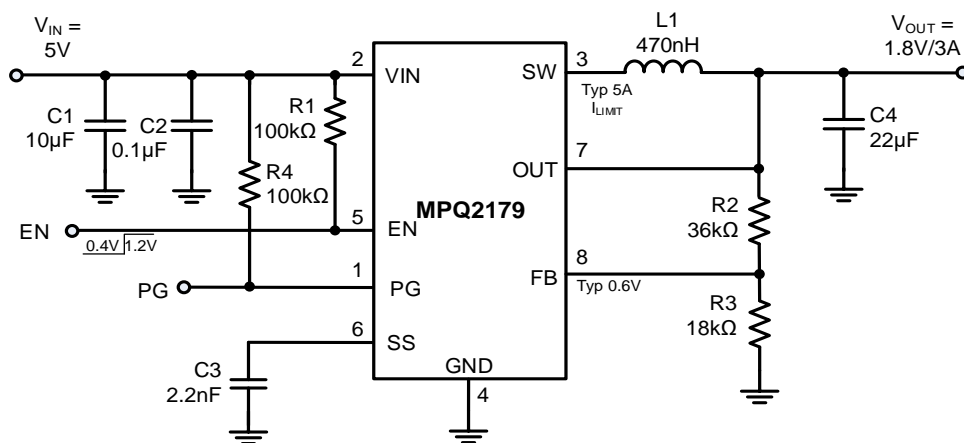
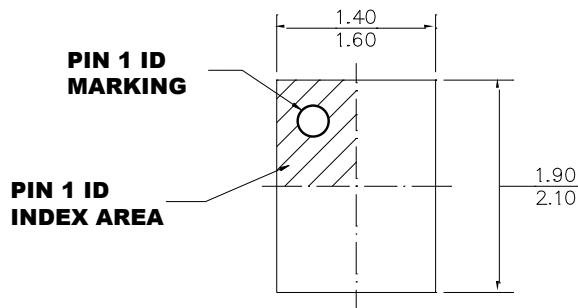

Figure 5: 1.8V Output Application Circuit for the MPQ2179

PACKAGE INFORMATION

QFN-8 (1.5mmx2mm) Wettable Flank



TOP VIEW

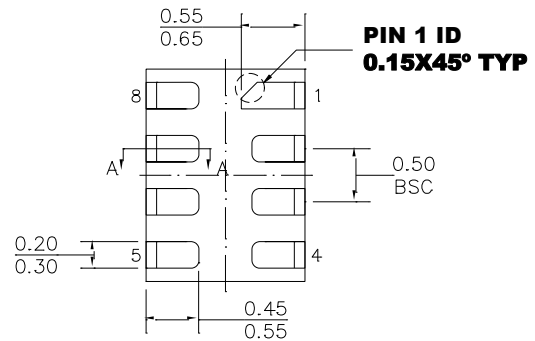

BOTTOM VIEW

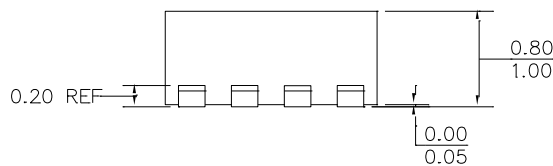

SIDE VIEW

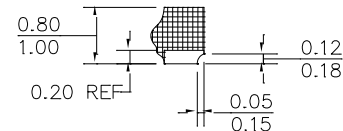

SECTION A-A

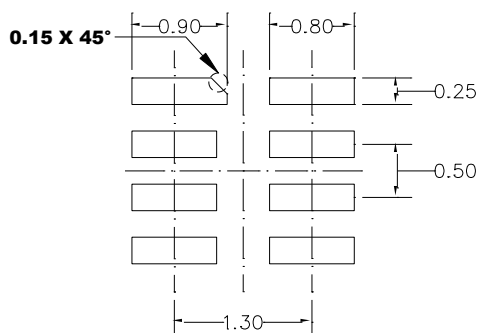

RECOMMENDED LAND PATTERN

NOTE:

- 1) THE LEAD SIDE IS WETTABLE.
- 2) ALL DIMENSIONS ARE IN MILLIMETERS.
- 3) LEAD COPLANARITY SHALL BE 0.08 MILLIMETERS MAX.
- 4) JEDEC REFERENCE IS MO-220.
- 5) DRAWING IS NOT TO SCALE.

CARRIER INFORMATION

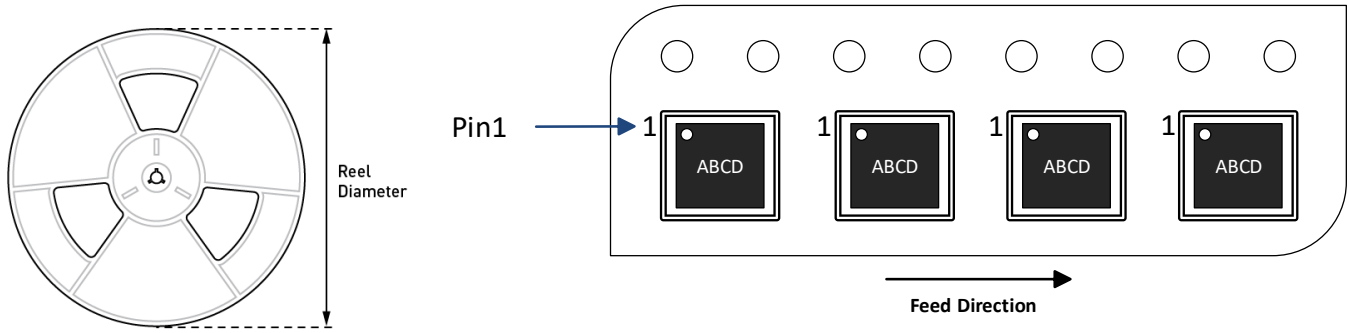

| Part Number | Package Description | Quantity/ Reel | Quantity/ Tube | Quantity/ Tray | Reel Diameter | Carrier Tape Width | Carrier Tape Pitch |
|--------------------|----------------------|----------------|----------------|----------------|---------------|--------------------|--------------------|
| MPQ2179GQHE-Z | QFN-8 (1.5mmx2mm) | 5000 | N/A | N/A | 13in | 8mm | 4mm |
| MPQ2179GQHE-AEC1-Z | | | | | | | |

REVISION HISTORY

| Revision # | Revision Date | Description | Pages Updated |
|------------|---------------|-----------------|---------------|
| 1.0 | 2/23/2021 | Initial Release | - |

NOTICE: The information in this document is subject to change without notice. Please contact MPS for current specifications. Users should warrant and guarantee that third party Intellectual Property rights are not infringed upon when integrating MPS products into any application. MPS will not assume any legal responsibility for any said applications.