

**SERIES: VMS-450C | DESCRIPTION: AC-DC POWER SUPPLY**
**FEATURES**

- 90~264 Vac and 127~370 Vdc input voltage range
- 3" x 5" open-frame footprint
- 250 W under natural convection, 450 W with airflow
- -40 ~ 70 °C temperature range
- active PFC
- 5 Vsby, 12 Vfan, power good, remote sense
- suitable for BF applications
- certified to 60601 safety standard
- designed to meet 60335 & 61558 safety requirements



MODEL	output voltage		output current max (A)	output power <sup>2</sup> max (W)	ripple and noise <sup>3</sup> max (mVp-p)	efficiency <sup>4</sup> typ (%)
	(Vdc)	range <sup>1</sup> (Vdc)				
VMS-450C-12	12	11.4~12.6	33.30	400	200	91.0
VMS-450C-15	15	14.25~15.75	26.70	400	200	92.0
VMS-450C-24	24	22.8~25.2	18.75	450	200	93.0
VMS-450C-27	27	25.65~28.35	16.70	450	200	93.5
VMS-450C-36	36	34.2~37.8	12.50	450	200	93.0
VMS-450C-48	48	45.6~50.4	9.40	450	200	94.0

Notes:

1. When adjusting the output voltage care should be taken never to exceed the stated output power or output current of the unit.
2. With 25 CFM forced air cooling.
3. At full load, nominal input, 20 MHz bandwidth oscilloscope, tip & barrel method, output terminated with 47  $\mu$ F electrolytic and 0.1  $\mu$ F ceramic capacitors.
4. At 230 Vac.

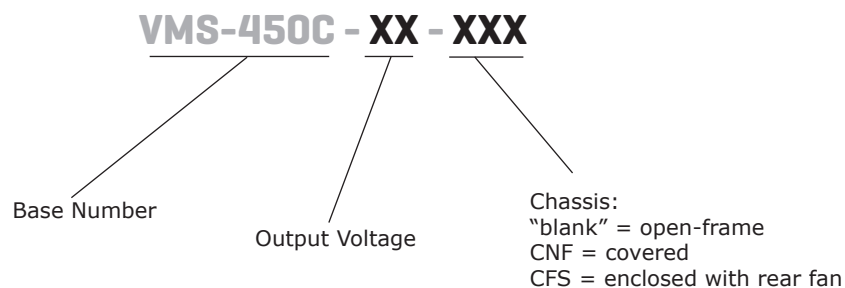
**PART NUMBER KEY**

**INPUT**

parameter	conditions/description	min	typ	max	units
voltage	ac input	90		264	Vac
	dc input	127		370	Vdc
frequency		47		63	Hz
current	at 90/115 Vac			5.2	A
	at 230 Vac			2.6	A
inrush current	at 115 Vac, cold start		40		A
	at 230 Vac, cold start		80		A
leakage current	at 264 Vac			0.1	mA
	contact leakage current earth leakage current			0.5	mA
power factor correction	at 115 Vac, full load	0.98			
	at 230 Vac, full load	0.95			
no load power consumption	at 230 Vac, PS-ON signal held low (output disabled)			0.5	W

**OUTPUT**

parameter	conditions/description	min	typ	max	units
output capacitance	12, 15, 24 Vdc output models			6,000	μF
	27 Vdc output model			4,000	μF
	36 Vdc output model			3,000	μF
	48 Vdc output model			2,000	μF
initial set point accuracy	full load				
	12,15, 24 Vdc output models all other output models		±2 ±1		% %
line regulation	rated load		±0.5		%
load regulation	0 ~ 100% load		±1		%
hold-up time	at 115 Vac, 25°C, full load	12			ms
	at 230 Vac, 25°C, full load	16			ms
temperature coefficient			±0.03		%/°C
fan power	output power of 12 Vdc/0.5A			6	W

**PROTECTIONS**

parameter	conditions/description	min	typ	max	units
over voltage protection	output shutdown, latching				
	12 Vdc output model			15.6	Vdc
	15 Vdc output model			19.5	Vdc
	24 Vdc output model			31.2	Vdc
	27 Vdc output model			35.1	Vdc
	36 Vdc output model 48 Vdc output model			46.8 60.0	Vdc Vdc
over current protection	auto recovery, hiccup	105			%
short circuit protection	continuous, auto recovery, hiccup, recovery time <5s				
over temperature protection	output shutdown, auto recovery				

**SAFETY & COMPLIANCE**

parameter	conditions/description	min	typ	max	units
isolation voltage	input to output, 1 min, <5mA	4,000			Vac
	input to ground, 1 min, <5mA	2,000			Vac
	output to ground, 1 min, <5mA	1,500			Vac
isolation level	input to output	2 x MOPP			
	input to ground	1 x MOPP			
	output to ground	1 x MOPP			
safety approvals	certified to 60601: EN/UL designed to meet 60335: EN designed to meet 61558: EN				
safety class	Class I				
conducted emissions <sup>5</sup>	EN55011(CISPR32) CLASS B				
radiated emissions <sup>5</sup>	EN55011(CISPR32) CLASS B				
harmonic current	IEC/EN61000-3-2 CLASS A and CLASS D				
flicker	IEC/EN61000-3-3				
ESD	IEC/EN61000-4-2 Contact ±8KV/Air ±15KV, perf. Criteria A				
radiated immunity	IEC/EN61000-4-3 10V/m, perf. Criteria A				
EFT/burst	IEC/EN61000-4-4 ±2KV, perf. Criteria A				
surge	IEC/EN61000-4-5 line to line ±2KV, line to ground ±4KV, perf. Criteria A				
conducted immunity	IEC/EN61000-4-6 10Vr.m.s, perf. Criteria A				
voltage dips and interruptions	IEC/EN61000-4-11 0%, 70% perf. Criteria B				
MTBF	as per MIL-HDBK-217F at 25°C	200,000			hours
RoHS	yes				

Note: 5. The power supply is considered a component of the end system. All EMC performance has been tested on a metal plate with the dimensions 360 x 360 x 1 mm. The power supply must be integrated into the end system for proper electromagnetic compatibility testing.

**ENVIRONMENTAL**

parameter	conditions/description	min	typ	max	units
operating temperature	see derating curves	-40		70	°C
storage temperature		-40		85	°C
operating humidity	non-condensing	20		90	%
storage humidity	non-condensing	10		95	%

## DERATING CURVES

**TEMPERATURE DERATING CURVE**  
(full load 400W with 25 CFM)  
VMS-450C-12, VMS-450C-15

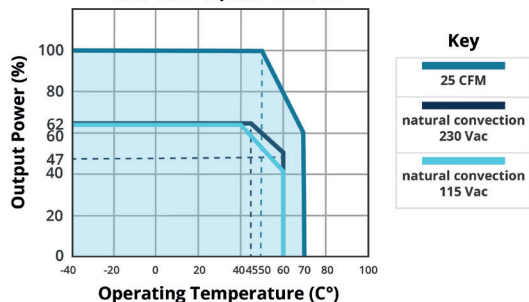

**TEMPERATURE DERATING CURVE**  
(full load 450W with 25 CFM)  
VMS-450C-24, VMS-450C-27  
VMS-450C-36, VMS-450C-48

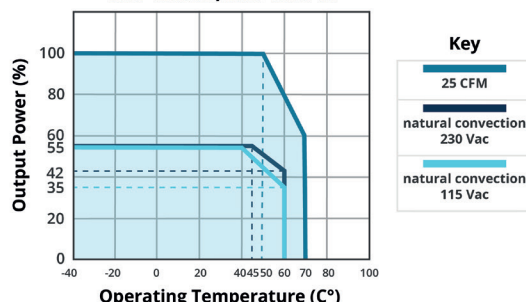

**TEMPERATURE DERATING CURVE**  
(full load 400W with 25 CFM)  
VMS-450C-12-CNF, VMS-450C-15-CNF

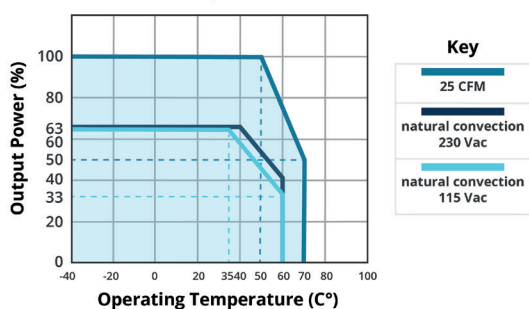

**TEMPERATURE DERATING CURVE**  
(full load 450W with 25 CFM)  
VMS-450C-24-CNF, VMS-450C-27-CNF  
VMS-450C-36-CNF, VMS-450C-48-CNF

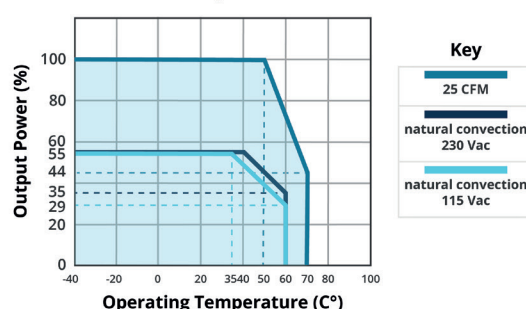

**TEMPERATURE DERATING CURVE**  
(full load 400W with 25 CFM)  
VMS-450C-12-CFS, VMS-450C-15-CFS

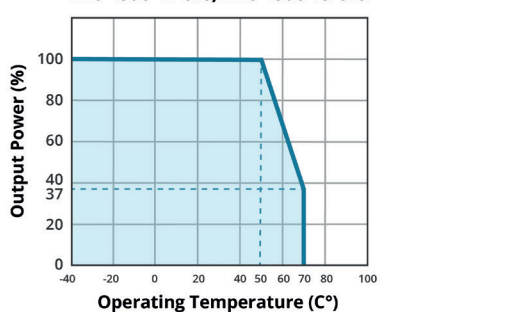

**TEMPERATURE DERATING CURVE**  
(full load 450W with 25 CFM)  
VMS-450C-24-CFS, VMS-450C-27-CFS  
VMS-450C-36-CFS, VMS-450C-48-CFS

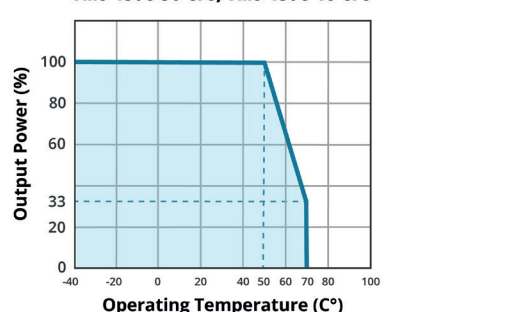

**INPUT VOLTAGE DERATING CURVE**  
(25°C)

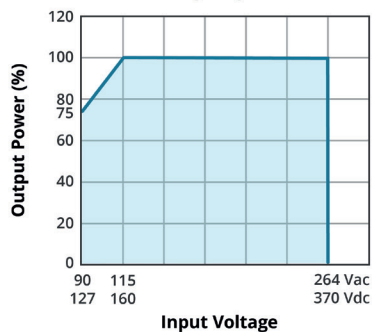

Note: With an AC input voltage between 90 ~ 115 Vac and a DC input between 127 ~ 160 Vdc the output power must be derated as per the temperature derating curves.

## EFFICIENCY CURVES

**EFFICIENCY VS INPUT VOLTAGE**  
*(full load)*

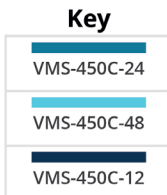
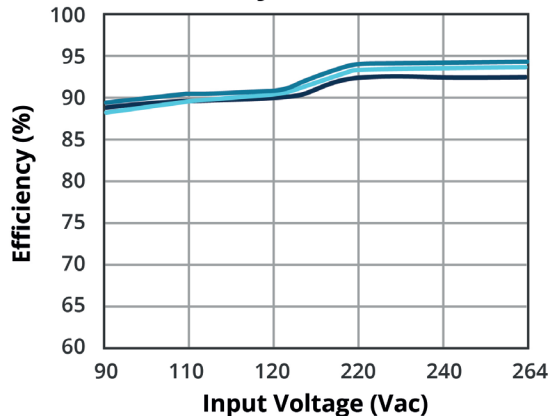

**EFFICIENCY VS OUTPUT LOAD**  
*(Vin = 230 Vac)*

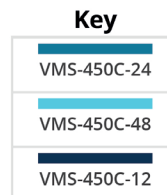
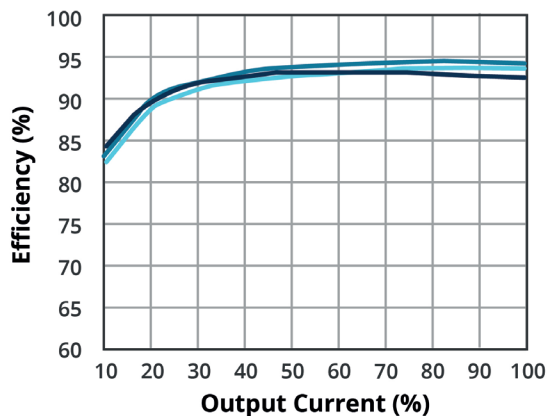

**EFFICIENCY VS INPUT VOLTAGE**  
*(full load)*

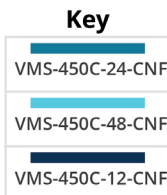
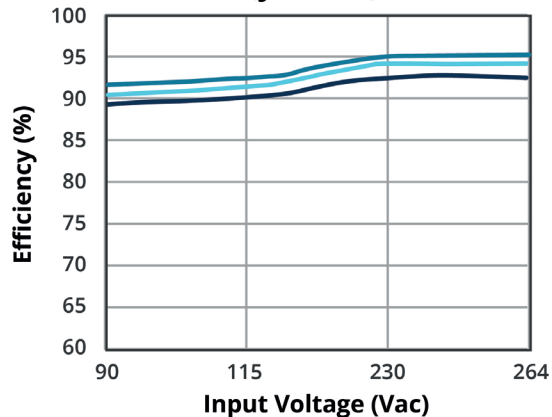

**EFFICIENCY VS OUTPUT LOAD**  
*(Vin = 230 Vac)*

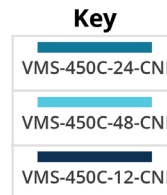
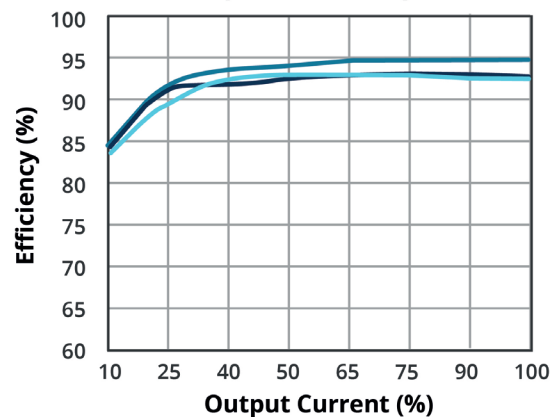

**EFFICIENCY VS INPUT VOLTAGE**  
*(full load)*

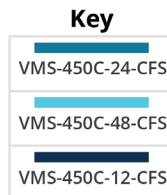
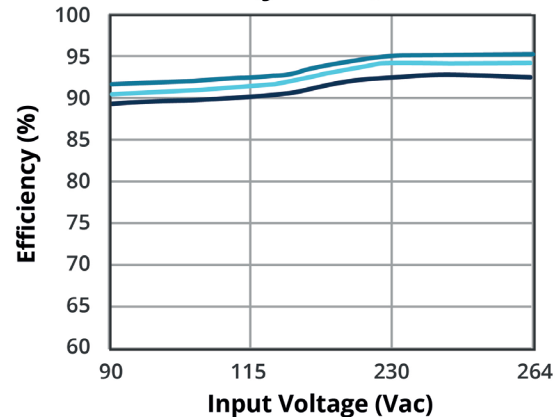

**EFFICIENCY VS OUTPUT LOAD**  
*(Vin = 230 Vac)*

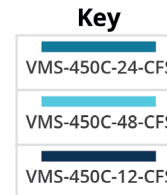
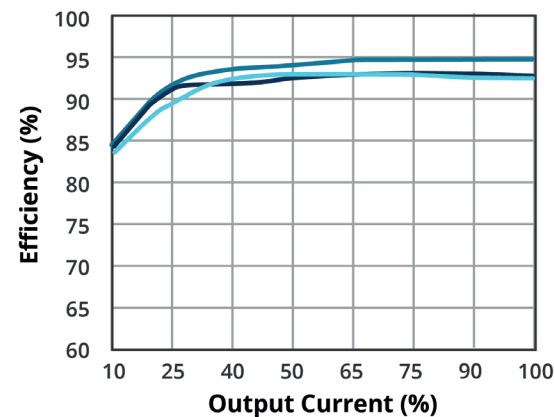

## MECHANICAL

parameter	conditions/description	min	typ	max	units
dimensions	open frame models: 127 × 76.2 × 38.5 [5.0 × 3.0 × 1.515 inch]				mm
	covered models: 130.0 × 86.0 × 43.0 [5.118 × 3.385 × 1.692 inch]				mm
	with rear fan: 160.0 × 86.0 × 43.0 [6.299 × 3.385 × 1.692 inch]				mm
weight	open frame models		400		g
	covered models		605		g
	with rear fan		645		g
cooling	natural convection or 25 CFM forced air				

## MECHANICAL DRAWING

### open-frame

units: mm [inch]

general tolerance: ±1.00 [±0.039]

pin 7,8 connector tightening torque: M4, 1.2N·m (max)

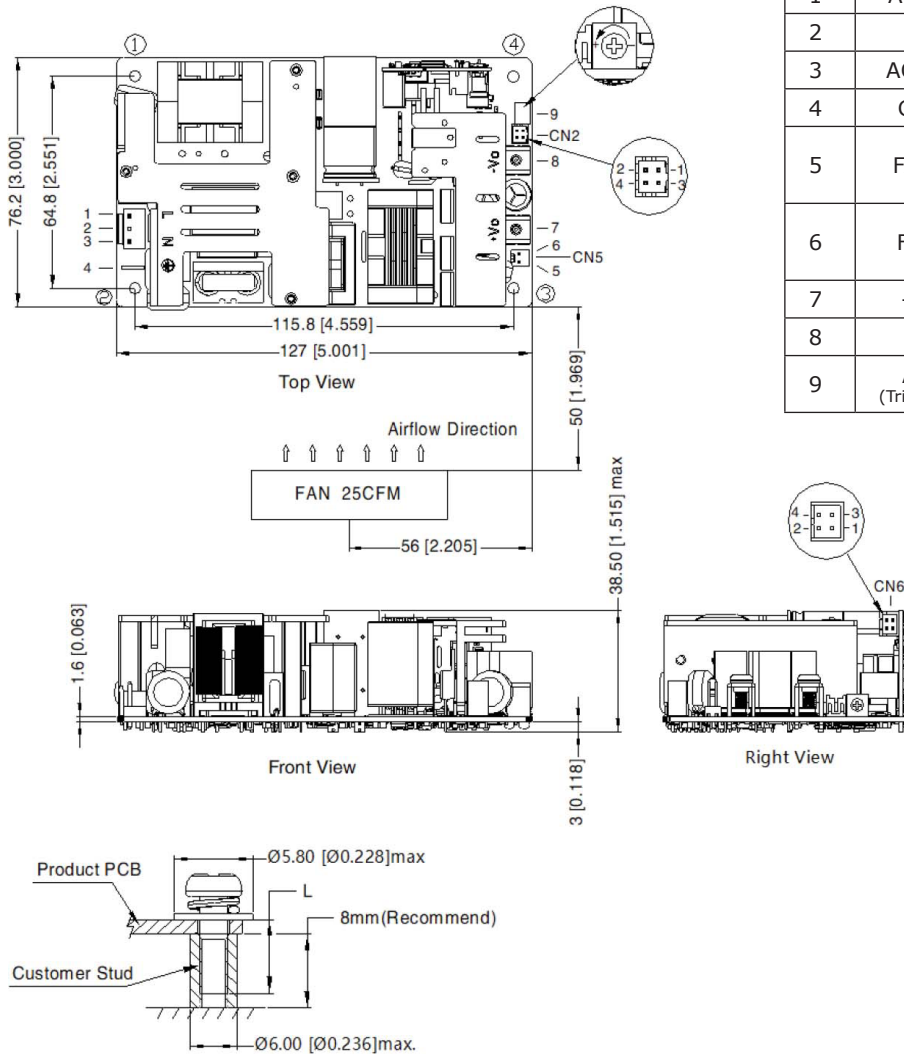

PIN-OUT		
PIN	Function	Mating Connector
1	AC (L)	Housing: JST VHR or equivalent Contact: JST SVH-21T-P1.1 or equivalent
2	NC	
3	AC (N)	
4	GND	Contact: JST SPS-21T-250
5	FAN+	CN5: Fan power output port Housing: TKP 2502 or equivalent Contact: TKP 8811 or equivalent
6	FAN-	
7	+Vo	
8	-Vo	
9	ADJ (Trim POT)	

CN6: PS_ON signal input port (3-4) 5Vdc standby (1-2)		
PIN	Function	Mating Connector
1	+5V	Housing: JST PHD-2*2Y or equivalent Contact: JST PHD-TE or equivalent
2	GND	
3	PS-ON	
4	GND	

CN2: remote sensing signal input port (1-2) PG signal (3-4)		
PIN	Function	Mating Connector
1	RS-	Housing: JST PHD-2*2Y or equivalent Contact: JST PHD-TE or equivalent
2	RS+	
3	GND	
4	PG	

Position	Screw Spec.	L (recommended)	Torque (max)
①~④	M3	6mm	0.4 N·m

Note: 1. Class I system ①, ②, ③ positions must be connected to the protective earth ground (⊕).  
2. It is recommended that a minimum distance of 10mm be placed between the PCB edge and all other components.

## MECHANICAL DRAWING (CONTINUED)

**covered**

units: mm [inch]

general tolerance: ±1.00 [±0.039]

pin 7,8 connector tightening torque: M4, 1.2N·m (max)

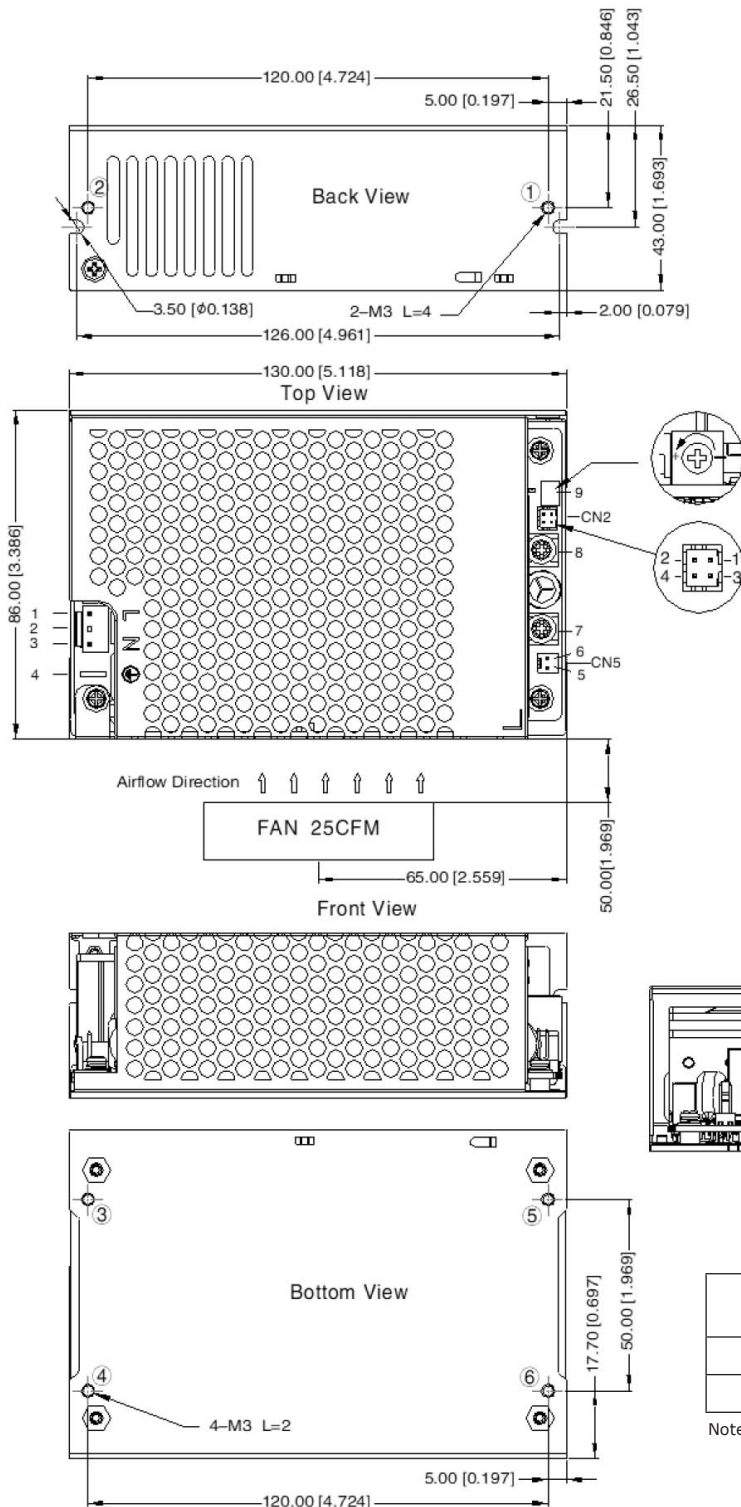

PIN-OUT		
PIN	Function	Mating Connector
1	AC (L)	Housing: JST VHR or equivalent Contact: JST SVH-21T-P1.1 or equivalent
2	NC	
3	AC (N)	Contact: JST SPS-21T-250
4	GND	
5	FAN+	CN5: Fan power output port Housing: TKP 2502 or equivalent Contact: TKP 8811 or equivalent
6	FAN-	
7	+Vo	
8	-Vo	
9	ADJ (Trim POT)	

CN6: PS_ON signal input port (3-4) 5Vdc standby (1-2)		
PIN	Function	Mating Connector
1	+5V	Housing: JST PHD-2*2Y or equivalent
2	GND	
3	PS-ON	Contact: JST PHD-TE or equivalent
4	GND	

CN2: remote sensing signal input port (1-2) PG signal (3-4)		
PIN	Function	Mating Connector
1	RS-	Housing: JST PHD-2*2Y or equivalent
2	RS+	
3	GND	Contact: JST PHD-TE or equivalent
4	PG	

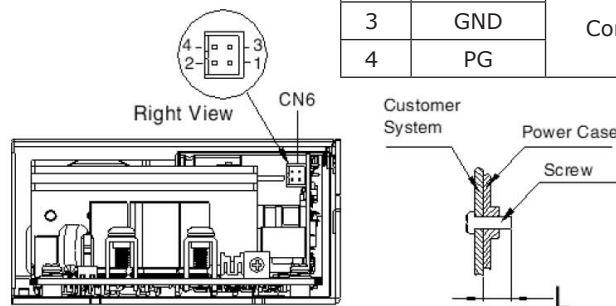

Position	Screw Spec.	L (max)	Torque (max)
①~②	M3	4mm	0.4 N·m
③~⑥	M3	2mm	0.4 N·m

Note: Safety Class I integrations require the metal case to be securely fastened to protective earth ground (⏚).



## MECHANICAL DRAWING (CONTINUED)

**with rear fan:**

units: mm [inch]

general tolerance: ±1.00 [±0.039]

pin 7,8 connector tightening torque: M4, 1.2N·m (max)

Position	Screw Spec.	L (max)	Torque (max)
①~④	M3	2mm	0.4 N·m

Note: Safety Class I integrations require the metal case to be securely fastened to protective earth ground (Ⓛ).

PIN-OUT		
PIN	Function	Mating Connector
1	AC (L)	Housing: JST VHR or equivalent Contact: JST SVH-21T-P1.1 or equivalent
2	NC	
3	AC (N)	
4	GND	Contact: JST SPS-21T-250
5	FAN+	CN5: Fan power output port Housing: TKP 2502 or equivalent Contact: TKP 8811 or equivalent
6	FAN-	
7	+Vo	
8	-Vo	
9	ADJ (Trim POT)	

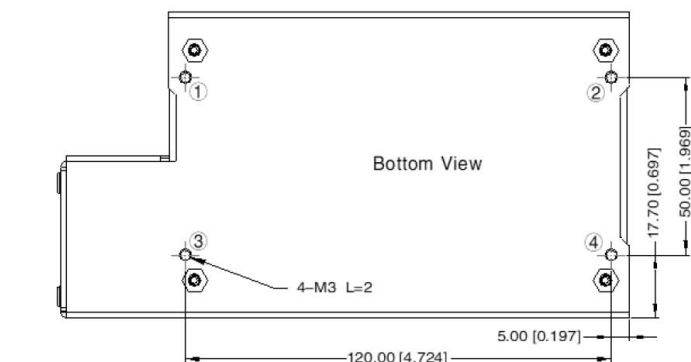
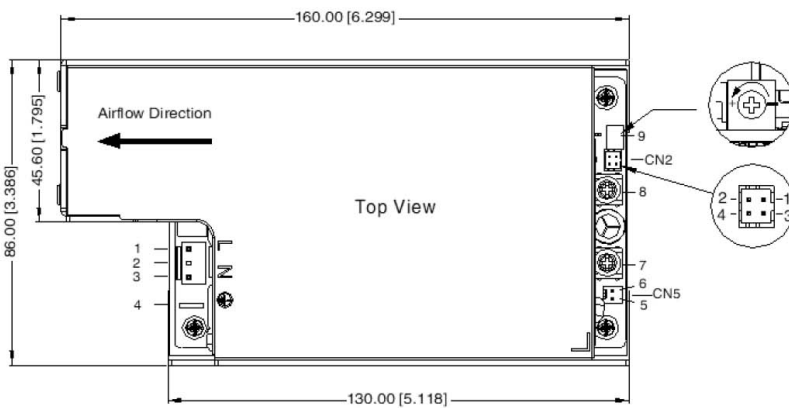
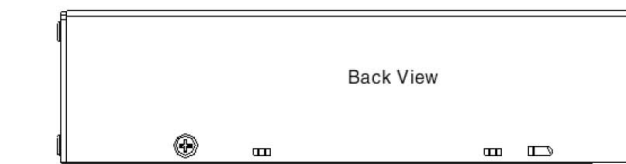

CN6: PS_ON signal input port (3-4) 5Vdc standby (1-2)		
PIN	Function	Mating Connector
1	+5V	Housing: JST PHD-2*2Y or equivalent
2	GND	
3	PS-ON	Contact: JST PHD-TE or equivalent
4	GND	

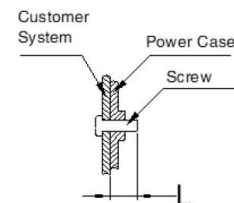
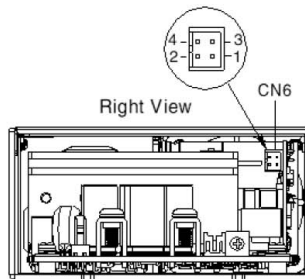

CN2: remote sensing signal input port (1-2) PG signal (3-4)		
PIN	Function	Mating Connector
1	RS-	Housing: JST PHD-2*2Y or equivalent
2	RS+	
3	GND	Contact: JST PHD-TE or equivalent
4	PG	



## REMOTE SENSE

Remote Sense signals (RS+ and RS-) can be used to compensate for voltage drops that occur within the output power cables. RS+ and RS- should always be routed as a twisted pair and never shorted together or reversed otherwise permanent damage may occur.

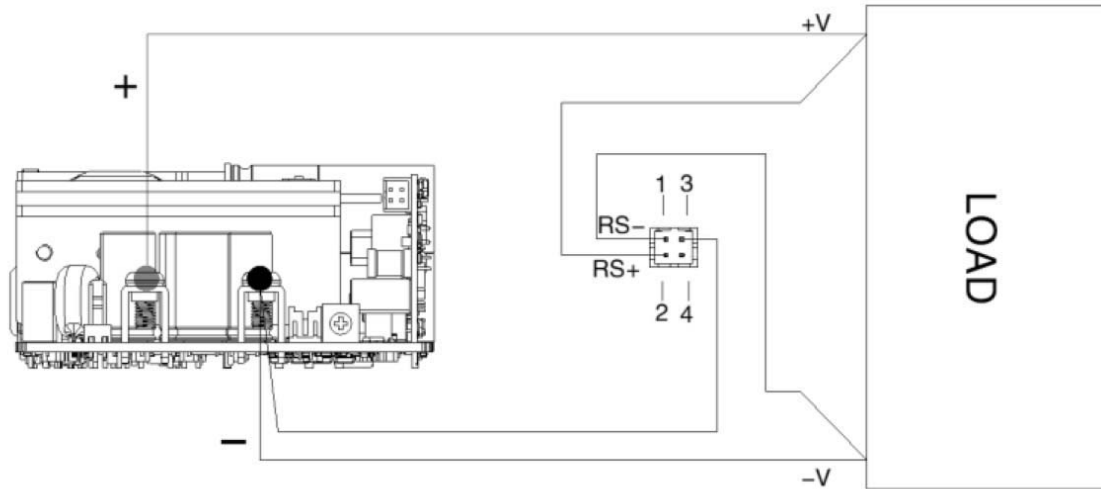

## REVISION HISTORY

---

rev.	description	date
1.0	initial release	12/21/2021

The revision history provided is for informational purposes only and is believed to be accurate.



**CUI INC**  
a bel group

**Headquarters**  
20050 SW 112th Ave.  
Tualatin, OR 97062  
**800.275.4899**

Fax 503.612.2383  
**cui.com**  
techsupport@cui.com

CUI offers a two (2) year limited warranty. Complete warranty information is listed on our website.

CUI reserves the right to make changes to the product at any time without notice. Information provided by CUI is believed to be accurate and reliable. However, no responsibility is assumed by CUI for its use, nor for any infringements of patents or other rights of third parties which may result from its use.

CUI products are not authorized or warranted for use as critical components in equipment that requires an extremely high level of reliability. A critical component is any component of a life support device or system whose failure to perform can be reasonably expected to cause the failure of the life support device or system, or to affect its safety or effectiveness.