

516-259 = 231-5E150 (MC 322-500).

CURTIS
Curtis Instruments (UK) Ltd

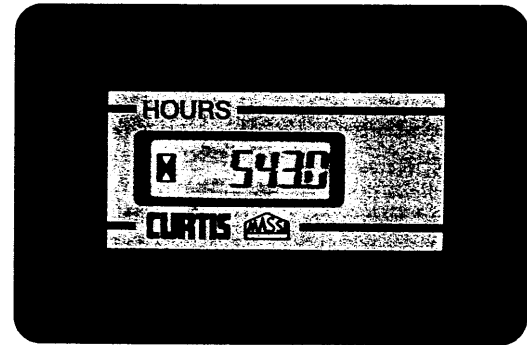
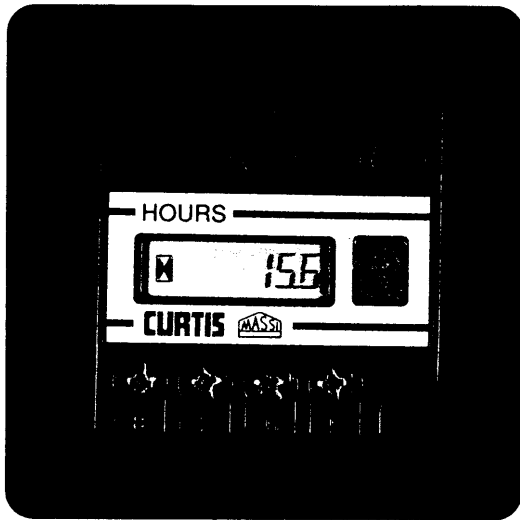

MINI - COUNTER 231

Hour meter for DC and AC with start input

Customers advantages

- wide temperature range, high shock resistance, low power consumption
- no batteries – nonvolatile logic memory
- high immunity from disturbance
- count- and reset-input to switch as operating voltage as 230 VAC

Technical data

Display

6 digits, 7 segment LCD, 5 mm digit height,
Leading zero blanking for the first 4 digits
Display capacity 999999

Operating voltage

12 to 60 VDC and 2 ranges, 12 VAC to 230 VAC

Start input

For DC static H-level, for AC static L1 or N:
1 / 10 hour, Indicated by hourglass (3 sec on - 1 sec off)

Reset input

Minimum pulse width: 20 msec.
on closed contact: display off

Data retention

Data retention is minimum 25 years by the integrated EEPROM.

Power consumption

Power consumption depends on voltage.
Nominal power consumption: 860 mVA max
Nominal current consumption: 13 mA max

EMC

CE-conform
EMC according to DIN VDE 0843 T4: sharpness 4
for hardest industrial applications

Temperature/moisture

Temperature range for
storage and operation: - 30 °C to + 65 °C
Temperature/moisture: 90 % rel. moisture at 38 °C

Safety classification according to DIN 40050

Housing 3, 4: IP 30
Housing 5: IP 65

Resistance against vibration according to DIN IEC 68 T 2-6

FC 10/500 - 0.35/50 - 30/3

Weight

Housing 3: 50 g
Housing 4: 48 g
Housing 5: 33 g

Housing material / Burn characteristic

plastics PA; burn behavior VO according to UL standard 94

Wiring

Screw terminal connection,
max. pin cross-section: 2 x 1,5 mm²

Drawings

Housing 3

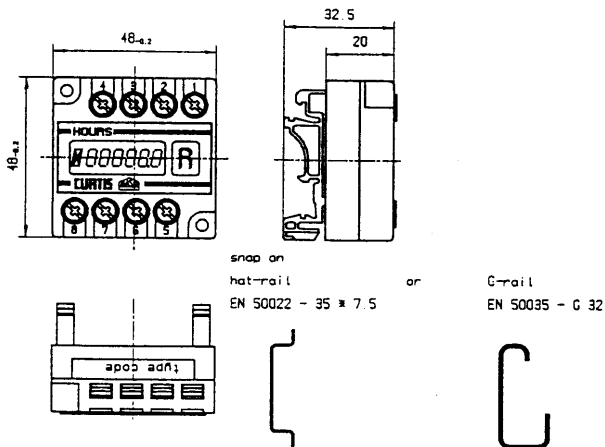

Housing 4

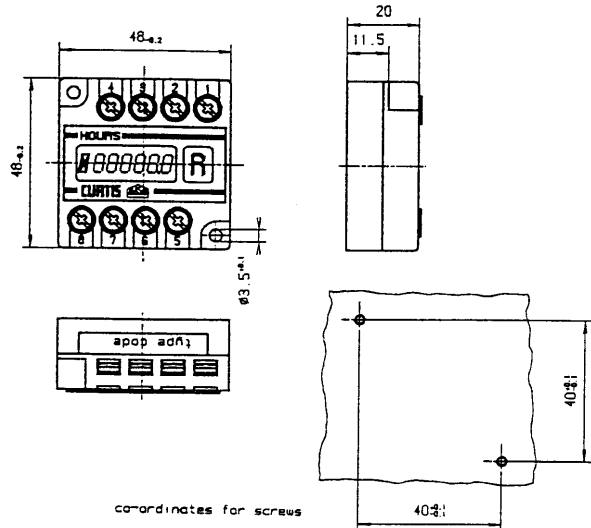

Housing 5

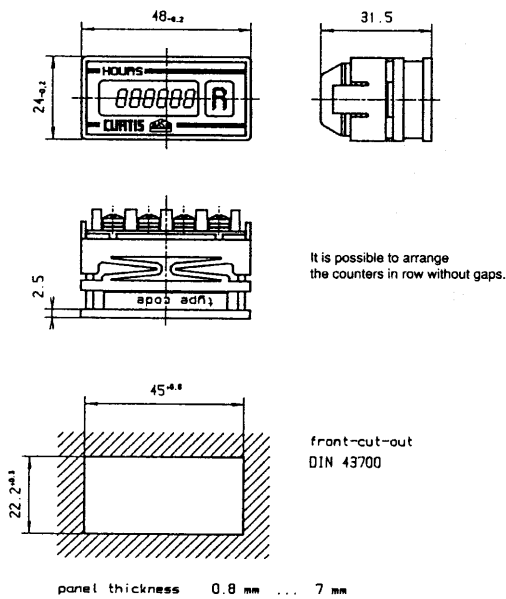

Connection scheme

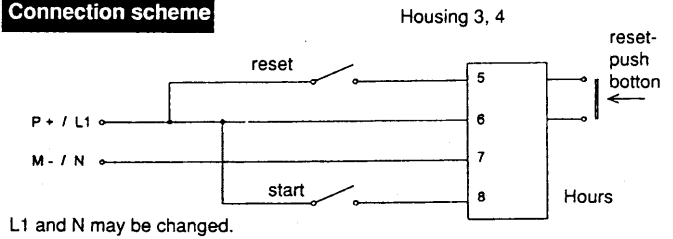

Connection scheme

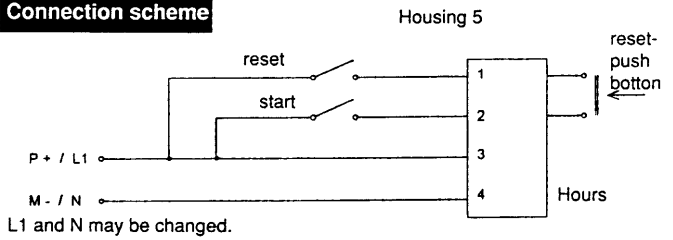

Type selection

(order marking)

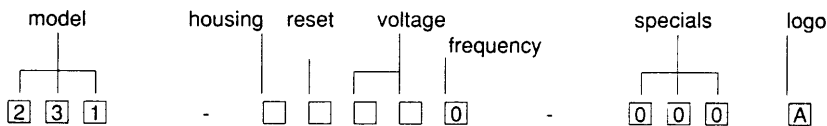

- housing:**
- 3 48x48 / DIN rail mounting / screw terminal connections
 - 4 48x48 / built-on mounting / screw terminal connections
 - 5 DIN 24x48x31.5 / front panel mounting / screw terminal connections

voltage:

nominal voltage	absolute limits
21 12 to 60 VDC	9,6 to 66 VDC
21 12 to 60 VAC	9,6 to 66 VAC
50 / 60 Hz	
15 80 to 230 VAC	72 to 253 VAC
50 / 60 Hz	

- reset:**
- N no reset
 - E electrical reset
 - M manual and electrical reset

CURTIS INSTRUMENTS (UK) LTD

51 GRAFTON STREET
NORTHAMPTON NN1 2NT
ENGLAND

Tel.: (0604) 29755
Fax: (0604) 29876

Technical modifications reserved! (9/93)