

HIGH PERFORMANCE



**POSITRONIC**<sup>®</sup>

GLOBAL *Connector* SOLUTIONS

LOOK FOR OUR NEW PRODUCTS!



**Goddard Space Flight Center S-311-P-4  
Goddard Space Flight Center S-311-P-10  
MIL-DTL-24308 Class M**



Catalog C-005 Rev. **B1**

[www.connectpositronic.com](http://www.connectpositronic.com)

# Connector Excellence®

**Positronic Provides Complete Capability**

## Mission Statement

*"To utilize product flexibility and application assistance to present interconnect solutions which represent value to customers worldwide."*

## Experience

- Founded in **1966**
- **Involvement** in the development of international connector specifications through EIA®, IEC and ISO as well as PICMG® and VITA.
- Introduction of new and **unique connector products** to the electronics industry.
- Patent holder for many **unique connector features and manufacturing techniques**.
- **Vertically integrated** manufacturing – raw materials to finished connectors.

## Technology

- **Expertise** with solid machined contacts provides a variety of high reliability connectors including high current density power connectors.
- Quality Assurance lab is **capable of testing** to IEC, EIA, UL, C.UL, military and customer-specified requirements.
- **In-house design and development** of connectors based on market need or individual customer requirements.
- **Internal manufacturing capabilities** include automatic precision contact machining, injection molding, stamping, plating operations and connector assembly.
- **Manufacturing locations** in southwest Missouri, U.S.A. (headquarters); Puerto Rico, France, China, Singapore, and India. Total square footage: 369,000.

## Support

- **Quality Systems:** Select locations qualified to ISO9001:2000, ISO14001, AS9100, MIL-STD-790 and customer "dock to stock" programs. Applicable products qualified to MIL-DTL-24308, SAE AS39029, DSCC 85039, MIL-DTL-28748, Space D32, GSFC S-311-P-4 and GSFC S-311-P-10.
- Compliance to a variety of international and customer specific **environmental requirements**.
- Large **in-house inventory** of finished connectors. Customer specific **stocking programs**.
- Factory direct **technical sales support** in major cities worldwide.
- **One-on-one customer support** from worldwide factory locations.
- World class **web site**.
- **Value-added solutions** and willingness to **develop custom products** with reasonable price and delivery.



## Regional Headquarters

Springfield, MO



Auch, France



Singapore



Products described within this catalog may be protected by one or more of the following US patents:

#4,900,261 #5,255,580 #5,329,697  
#6,260,268 #6,835,079 #7,115,002

Patented in Canada, 1992 Other Patents Pending

Positronic Industries' **FEDERAL SUPPLY CODE** (Cage Code)  
FOR MANUFACTURERS is **28198**

Unless otherwise specified, **dimensional tolerances are:**

- 1) ±0.001 inches [0.03 mm] for male contact mating diameters.
- 2) ±0.003 inches [0.08 mm] for contact termination diameters.
- 3) ±0.005 inches [0.13 mm] for all other diameters.
- 4) ±0.015 inches [0.38 mm] for all other dimensions.

**POSITRONIC® IS AN ITAR REGISTERED COMPANY**

Information in this catalog is proprietary to Positronic and its subsidiaries. Positronic believes the data contained herein to be reliable. Since the technical information is given free of charge, the user employs such information at his own discretion and risk. Positronic Industries assumes no responsibility for results obtained or damages incurred from use of such information in whole or in part.

Positronic®, Positronic Industries, Inc.®, P+ logo, Positronic Global Connector Solutions®, Connector Excellence® and their logo designs are registered trademarks of Positronic Industries, Inc.



## SND STANDARD DENSITY D-SUBMINIATURE CONNECTORS

Removable or fixed size 20 contacts. Crimp, solder cup, straight and right angle (90°) printed board mount contact terminations. Five connector variants, 9 through 50 contacts. Conforming to applicable material, dimensional and performance requirements of GSFC S-311-P4, GSFC S-311-P10 and MIL-DLT-24308 Class M.



## SDD HIGH DENSITY D-SUBMINIATURE CONNECTORS

Removable or fixed size 22 contacts. Crimp, solder, straight and right angle (90°) printed board contact terminations. Six connector variants, 15 through 104 contacts. Conforming to applicable material, dimensional and performance requirements of GSFC S-311-P4 and MIL-DLT-24308 Class M.



## SCBM STANDARD DENSITY COMBINATION D-SUBMINIATURE CONNECTORS

Fixed size 20 signal contacts. Size 8 power, shielded and high voltage contacts. Crimp, solder cup, straight and right angle (90°) printed board mount contact terminations. Twenty-two connector variants, 2WK2 through 46W4, using shell sizes 1 through 6. Conforming to applicable material, dimensional and performance requirements of GSFC S-311-P4, GSFC S-311-P10 and DSCC specification 85039.



## SCBC STANDARD DENSITY COMBINATION D-SUBMINIATURE CONNECTORS WITH REMOVABLE CRIMP CONTACTS

Removable size 20 signal contacts. Size 8 power, shielded, and high voltage removable contacts. Crimp and solder terminations. Sixteen connector variants, shell sizes 1 through 6. Conforming to applicable material, dimensional and performance requirements of GSFC S-311-P4, GSFC S-311-P10 and DSCC specification 85039.

*continued on next page . . .*



Positronic Industries  
connectpositronic.com

# CONNECTOR DESCRIPTIONS

High  
Performance  
D-sub

*continued from previous page . . .*



## SCBDD HIGH DENSITY COMBINATION D-SUBMINIATURE CONNECTORS

Fixed size 22 signal and size 16 power contacts. Size 8 power, shielded, and high voltage contacts. Crimp, solder cup, straight and right angle (90°) printed board terminations. Four connector variants, shell sizes 1 through 4. Conforming to applicable material, dimensional and performance requirements of GSFC S-311-P4, GSFC S-311-P10 and DSCC specification 85039.



## SCBCD HIGH DENSITY COMBINATION D-SUBMINIATURE CONNECTORS WITH REMOVABLE CRIMP CONTACTS

Removable size 22 signal and size 16 power contacts. Size 8 power, shielded, and high voltage removable contacts. Crimp and solder terminations. Three connector variants, shell sizes 1, 2 and 4. Conforming to applicable material, dimensional and performance requirements of GSFC S-311-P4, GSFC S-311-P10 and DSCC specification 85039.



## SAD, SADD, SACBMP CONNECTOR SAVER / GENDER CHANGER

Standard density, high density and combination connector savers and gender changers for use with SND, SDD, SCBM and SCBC connectors. Conforming to applicable material, dimensional and performance requirements of GSFC S-311-P4, GSFC S-311-P10 and DSCC specification 85039.

Visit our website for the latest catalog updates and supplements at  
<http://www.connectpositronic.com/products/62/HighPerformanceD-subminiature/catalogs/>





**G E N E R A L I N F O R M A T I O N**

What makes Positronic's new "PosiBand®" contact interface a significant improvement? .....	1
The PosiBand® contact system has many advantages over the legacy split tine design .....	2
Temperature Rise Curves .....	2-4



**S N D S E R I E S**

Technical Characteristics .....	5-6
Contact Variants .....	6
Standard Connector Housing (Shells) Assembly and Recommended Mating Dimensions .....	7
Solder Cup Termination and Straight Solder Printed Board Mount Termination .....	8
Right Angle (90°) Printed Board Mount Termination .....	9
Right Angle (90°) and Straight Solder Printed Board Contact Hole Pattern.....	10
Removable Contact Ordering Assistance Chart .....	11
Ordering Information .....	12



**S D D S E R I E S**

Technical Characteristics .....	13-14
Contact Variants .....	14
Standard Connector Housing (Shells) Assembly and Recommended Mating Dimensions .....	15
Straight Solder Printed Board Mount Termination and Right Angle (90°) Printed Board Mount Termination .....	16
Right Angle (90°) and Straight Solder Printed Board Contact Hole Pattern.....	17
Removable Contact Ordering Assistance Chart .....	18
Ordering Information .....	19



**S C B M S E R I E S**

Technical Characteristics .....	20-21
Contact Variants .....	22
Standard Connector Housing (Shells) Assembly and Recommended Mating Dimensions .....	23
Solder Cup Termination and Straight Solder Printed Board Mount Termination .....	24
Right Angle (90°) Printed Board Mount Termination .....	25-26
Metric System Right Angle (90°) Printed Board Mount Termination.....	27
Right Angle (90°) and Straight Solder Printed Board Contact Hole Pattern.....	28-31
Straight Solder and Right Angle (90°) Printed Board Termination with Shielded Contacts .....	32
Straight Solder Printed Board Mount and Right Angle (90°) Contact Hole Pattern for Shielded Contacts .....	33-36
Removable Contact Ordering Assistance Chart .....	37
Ordering Information .....	38



**S C B C S E R I E S**

Technical Characteristics .....	39-40
Contact Variants .....	41
Standard Connector Housing (Shells) Assembly and Recommended Mating Dimensions .....	42
Removable Contact Ordering Assistance Chart .....	43
Ordering Information .....	44



*continued on next page . . .*



## S C B D D S E R I E S

Technical Characteristics .....	45-46
Standard Connector Housing (Shells) Assembly and Recommended Mating Dimensions .....	47
Contact Variants and Solder Cup Termination.....	48
Straight Solder Printed Board Mount Termination .....	49
Right Angle (90°) Printed Board Mount Termination .....	49-50
Straight Solder and Right Angle (90°) Printed Board Termination with Shielded Contacts .....	51
Printed Board Mount and Right Angle (90°) Contact Hole Pattern for Shielded Contacts .....	52-53
Ordering Information for 8W2 Connector Variants (Size 16 Contacts).....	54
Removable Contact Ordering Assistance Chart .....	55
Ordering Information for 19W1, 15W4 and 45W2 Connector Variants (Size 8 Contacts).....	56

## S C B C D S E R I E S

Technical Characteristics .....	57-58
Contact Variants .....	58
Standard Connector Housing (Shells) Assembly and Recommended Mating Dimensions .....	59
Removable Contact Ordering Assistance Chart .....	60
Ordering Information .....	61

## S A D C O N N E C T O R S A V E R

Technical Characteristics .....	62
Contact Variants and Standard Connector Housing (Shells) Assembly Dimensions .....	63
Jackscrew Systems .....	64
Ordering Information .....	65

## S A D D C O N N E C T O R S A V E R

Technical Characteristics .....	66
Contact Variants and Standard Connector Housing (Shells) Assembly Dimensions .....	67
Ordering Information .....	68

## S A C B M P C O N N E C T O R S A V E R

Technical Characteristics .....	69-70
Contact Variants .....	70
Standard Connector Housing (Shells) Assembly Dimensions .....	71
Ordering Information .....	72

*continued on next page . . .*



## U N I Q U E F E A T U R E S

Unique Features Introduction .....	73
Sequential Mating Contacts .....	73
Size 8 Contact Stabilization Feature .....	74
Selectively Loaded Connector .....	74
Customer Specified Contact Termination Length .....	75
Low Profile Insulator .....	75
Compliant Press-In Connector .....	76
Dual Port Connector .....	76

## R E M O V A B L E C O N T A C T S

Technical Characteristics .....	77
Size 22 Removable Crimp and Closed Barrel Solder Contacts .....	78-79
Size 20 Removable Crimp and Closed Barrel Solder Contacts .....	79-80
Size 16 and Size 8 Removable Crimp Contacts .....	81
Size 8 Removable Solder Cup and Straight Solder Printed Board Mount Contacts .....	82
Size 8 Right Angle (90°) Printed Board Mount and Removable High Voltage Contacts .....	83
Size 8 Removable Shielded Contact .....	84
Size 8 Straight Solder and Right Angle (90°) Printed Board Mount Shielded Contact .....	85

## A C C E S S O R I E S

Riveted on Right Angle (90°) Mounting Brackets and Push-On Fastener for Riveted on Right Angle (90°) Brackets .....	86
Right Angle (90°) Metal Mounting Brackets .....	87
Swaged Spacers, Swaged Locknut and Swaged Spacer with Push-On Fastener .....	88
Threaded Post, Cul-de-Sac Style Mounting Accessories, and In-Line Crimp Splice .....	89
Blind Mating System and Metal Cable Adapter (Hood) .....	90
Aluminum Cable Adapter (Hood) .....	91-92
EMI/RFI Protective Cover .....	93
Jackscrew Systems and Polarized Jackscrew Systems .....	94

## S P E C I A L O P T I O N S

Modification (MOS) Suffixes .....	95
-----------------------------------	----

## A P P L I C A T I O N T O O L S

Introduction .....	96
Contact Application Tools Cross Reference List .....	97

## Q P L L I S T I N G

QPL Listing .....	98
-------------------	----



Positronic Industries  
connectpositronic.com



GENERAL INFORMATION

High  
Performance  
D-sub



## What Makes Positronic's New "PosiBand®" Contact

### Interface a Significant Improvement?

High reliability connectors utilize female **closed entry contacts** that provide an unbroken ring of solid material at the face of the contact. The closed entry feature is **crucial in preventing damage** to female contacts used in harsh environments, repeated mating cycles, blind mate applications and applications requiring highest reliability.

FIGURE 1

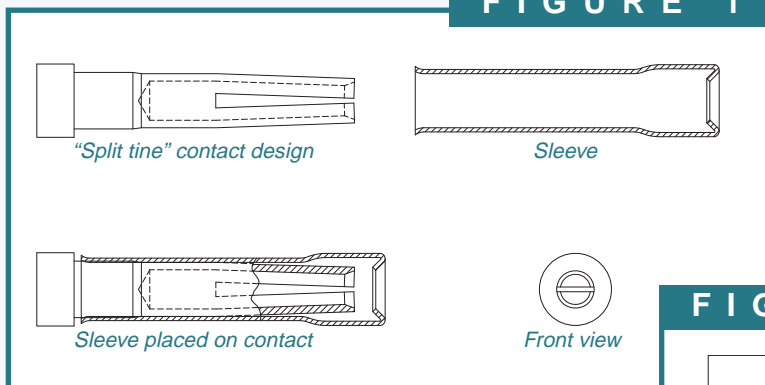

The most common **closed entry design** utilized by connector manufacturers is a split tine and sleeve concept. **See figure 1.** With this design, both the mechanical forces and

electrical interface are provided only at the tip of the female contact.

Positronic's new **PosiBand technology** takes a unique approach to closed entry female contacts.

**PosiBand** contacts utilize a two-piece contact design. **See figure 2.** Each piece serves a separate function, providing a more mechanically robust contact and more consistent electrical performance.

FIGURE 2

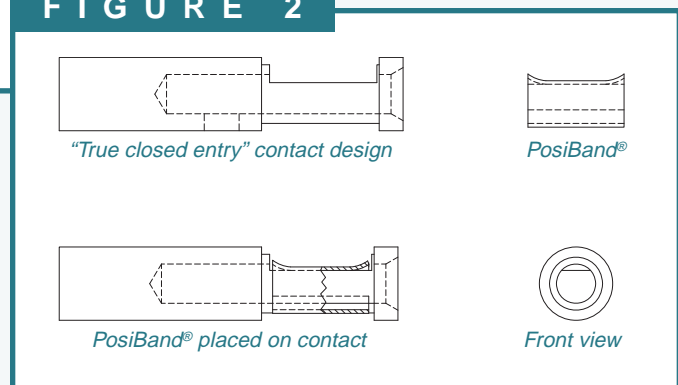

The main body of the **PosiBand** contact provides a true closed entry opening to enhance robustness. The **PosiBand** spring clip provides normal force on the male contact. Consistent electrical performance is supported through a larger area of contact interface between the male and female contact along the entire "floor" of the contact body. **PosiBand** contacts are QPL listed under **SAE AS39029** and qualified under **GSFC S-311-P4** to the higher 40 gram contact engagement test requirement.

*continued on next page . . .*





continued from previous page . . .

## The PosiBand® contact system has many advantages over the legacy split tine design.

- X** **PosiBand** is more robust than the split tine contact, which can be pried open in harsh environments, resulting in reduced normal force and degradation of electrical performance.
- X** **PosiBand** has greater surface area at the male and female contact interface, resulting in more consistent electrical performance.
- X** **PosiBand** has lower average insertion forces, resulting in greater ease in mating, especially in larger high density connectors. The average lower insertion force is accomplished while meeting or exceeding performance requirements.
- X** The **PosiBand's** contact body does not require annealing of the crimp barrels, as does the split tine design. This eliminates concern of unintentionally heat-treating the mating end of the contact, which can cause electrical failure.
- X** **PosiBand** is qualified under **SAE AS39029** specification. **PosiBand** is also qualified under **GSFC S-311-P4/08 Rev C** and **GSFC S-311-P4/10 Rev C** to the higher 40 gram contact engagement test requirement.

For more details about the *advantages of the PosiBand®* system, please view the detailed white paper at [www.connectpositronic.com/content/37/](http://www.connectpositronic.com/content/37/) or visit our web site at [www.connectpositronic.com](http://www.connectpositronic.com).



### TEMPERATURE RISE CURVES

Test conducted in accordance with UL1977.

#### Size 20 PosiBand Contacts

**Initial Contact Resistance:** 0.004 ohms, maximum.  
Curve developed using Standard Density D-subminiature connectors loaded with size 20 crimp contacts terminated to size 20 AWG wire.

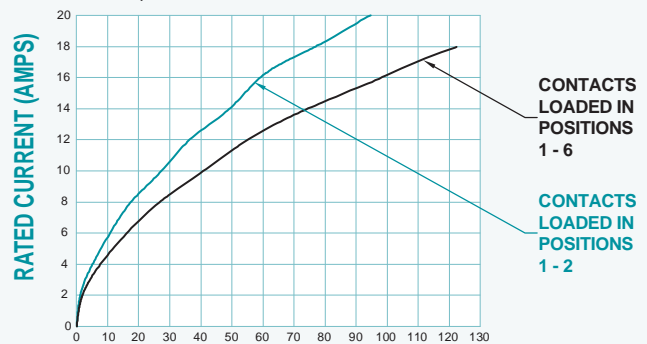

#### Size 22 PosiBand Contacts

**Initial Contact Resistance:** 0.005 ohms, maximum.  
Curve developed using High Density D-subminiature connectors loaded with size 22 crimp contacts terminated to size 22 AWG wire.

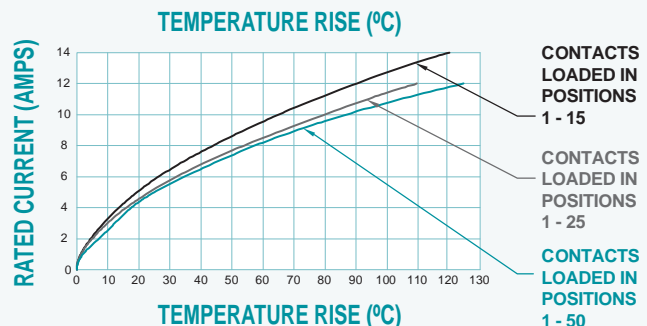
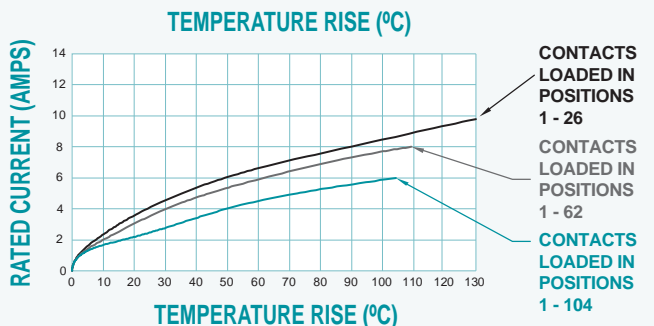
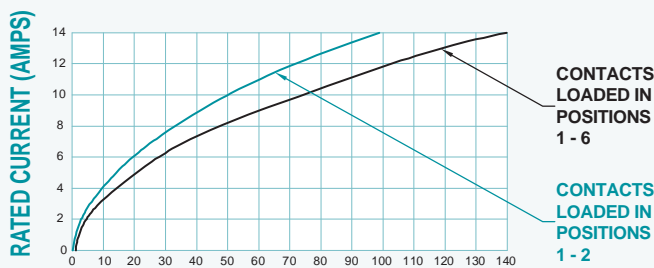



Positronic Industries  
connectpositronic.com



**TEMPERATURE RISE CURVES FOR SIZE 8, 10 AND 12 AWG WIRE**

*Test conducted in accordance with UL1977. All power contacts under load.*

**7W2**

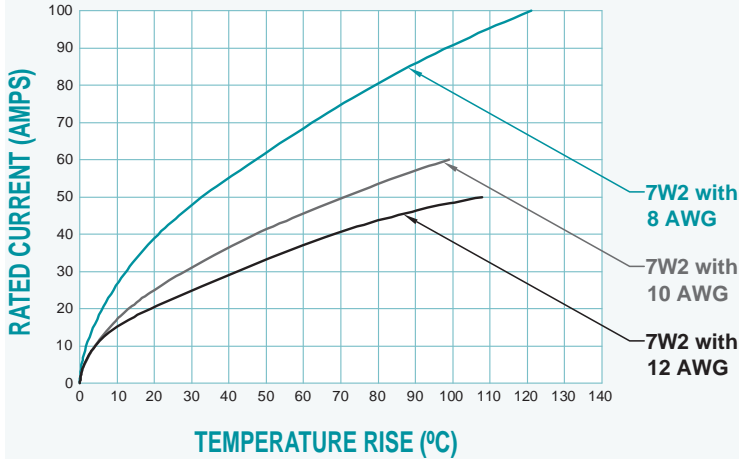

- 8 AWG:** Curve developed using a mated Combination-D 7W2F57 and Combination-D 7W2M loaded with size 8 crimp contacts terminated to 8 AWG wire.
- 10 AWG:** Curve developed using a mated Combination-D 7W2F3 and Combination-D 7W2M loaded with size 8 crimp contacts terminated to 10 AWG wire.
- 12AWG:** Curve developed using a mated Combination-D 7W2F55 and Combination-D 7W2M loaded with size 8 crimp contacts terminated to 12 AWG wire.

**21WA4**

- 8 AWG:** Curve developed using a mated Combination-D 21WA4F57 and Combination-D 21WA4M loaded with size 8 crimp contacts terminated to 8 AWG wire.
- 10 AWG:** Curve developed using a mated Combination-D 21WA4F36 and Combination-D 21WA4M loaded with size 8 crimp contacts terminated to 10 AWG wire.
- 12 AWG:** Curve developed using a mated Combination-D 21WA4F55 and Combination-D 21WA4M loaded with size 8 crimp contacts terminated to 12 AWG wire.

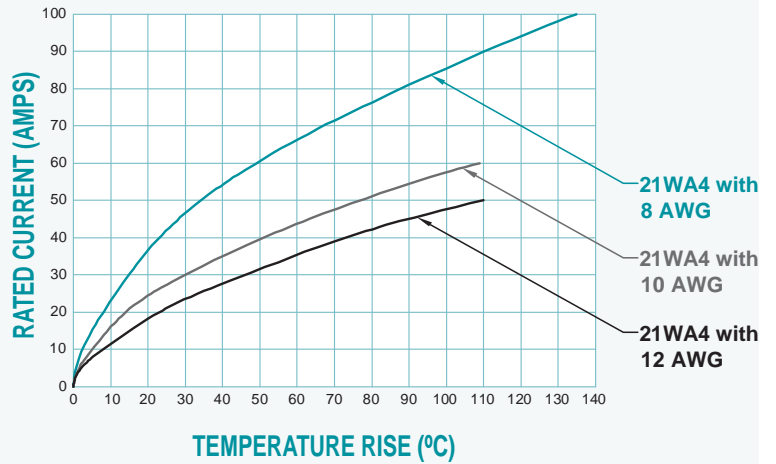

**8W8**

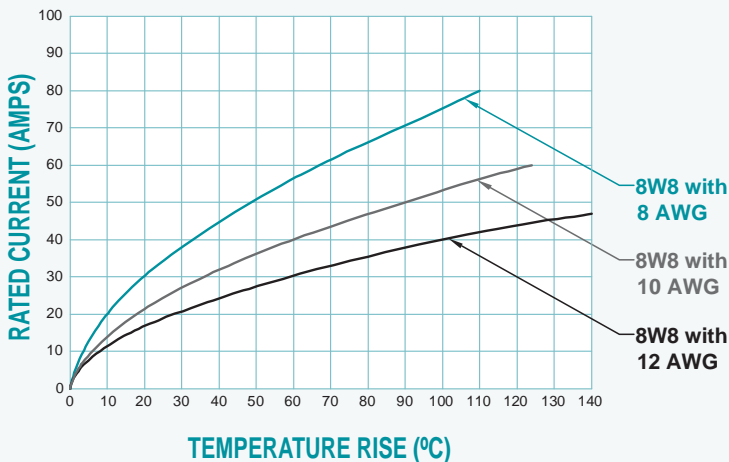

- 8 AWG:** Curve developed using a mated Combination-D 8W8F57 and Combination-D 8W8M loaded with size 8 crimp contacts terminated to 8 AWG wire.
- 10 AWG:** Curve developed using a mated Combination-D 8W8F36 and Combination-D 8W8M loaded with size 8 crimp contacts terminated to 10 AWG wire.
- 12AWG:** Curve developed using a mated Combination-D 8W8F55 and Combination-D 8W8M loaded with size 8 crimp contacts terminated to 12 AWG wire.



**TEMPERATURE RISE CURVE FOR SIZE 8 AND 12 AWG WIRE**

Test conducted in accordance with UL1977. All power contacts under load.

**3W3**

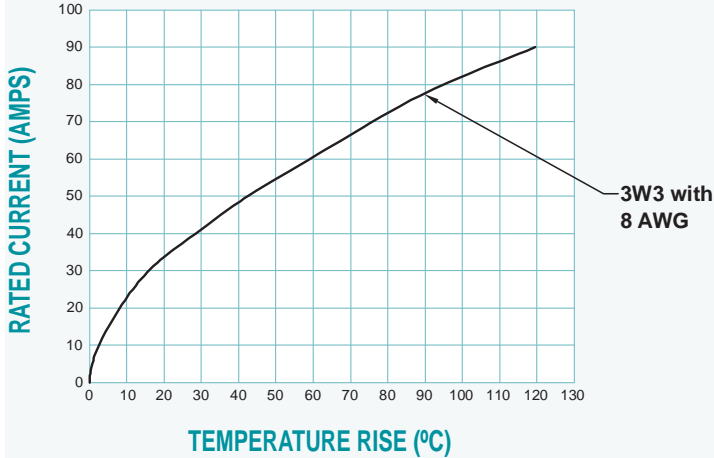

Curve developed using a mated Combination-D 3W3F loaded with size 8 crimp contacts and Combination-D 3W3M loaded with size 8 crimp contacts terminated to 8 AWG wire.

**8W8**

Curve developed using a mated Combination-D 8W8F loaded with size 8 crimp contacts and Combination-D 8W8M loaded with size 8 crimp contacts terminated to 8 AWG wire.

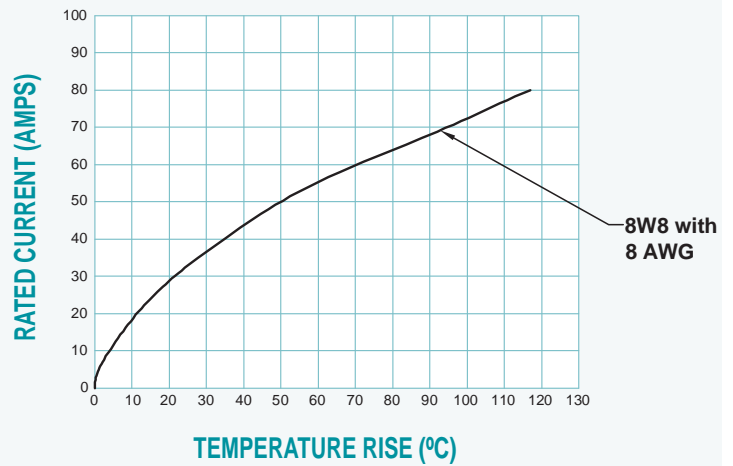

**HIGH DENSITY 8W2**

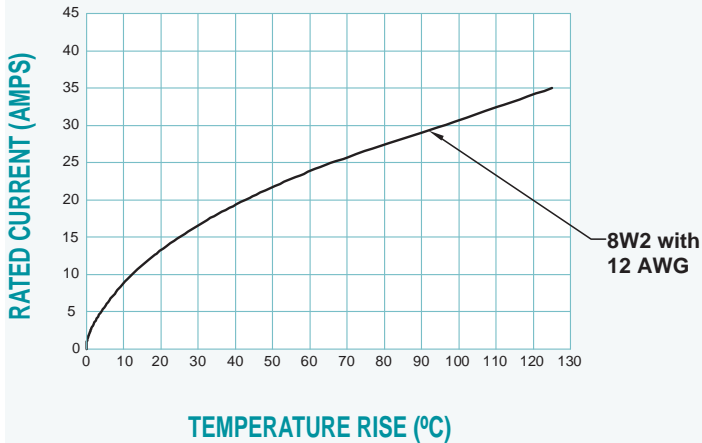

Curve developed using a mated Combination-D 8W2M loaded with size 8 crimp contacts and Combination-D 8W2S loaded with size 8 crimp contacts terminated to 12 AWG wire.



Positronic Industries  
connectpositronic.com

# SND SERIES

## MILITARY / SPACE FLIGHT QUALITY

### STANDARD DENSITY FIXED OR REMOVABLE CONTACTS

High  
Performance  
D-sub

SND SERIES



- High performance for use in harsh environments, including space flight.
- Size 20 **fixed or removable** contacts.
- Female closed entry contacts utilize the “PosiBand®” system. *See page 1 for details.* GSFC S-311-P-4/10 offers two contact engagement test options. Size 20 PosiBand contacts meet the higher 40 gram requirements per 4.2.2.b.
- Five connector variants include 9, 15, 25, 37, and 50 contacts.
- Terminations include cable or wire crimp and solder, straight and right angle PCB mount.
- Current ratings: signal level to 18 amperes. *See temperature rise curves on page 2 for details.*
- A wide variety of options and accessories.
- Applicable variants are qualified to GSFC and military specifications. *See page 98 for details.*

### Conforming To Applicable Material, Dimensional and Performance Requirements:

- GSFC S-311-P4 & GSFC S-311-P10
- MIL-DTL-24308 Class M

### Conforming To Outgassing Requirements:

- ASTM E-595 & NASA-RP-1124

## TECHNICAL CHARACTERISTICS

### MATERIALS AND FINISHES:

<b>Connector Insert:</b>	Glass-filled DAP per ASTM-D-5948, Type SDG-F, UL 94V-0, ASTM E-595, NASA-RP-1124, green color.
<b>Contacts:</b>	Precision machined copper alloy. 0.000050 inch [1.27 microns] gold over copper plate. Other finishes are available; see page 95.
<b>Connector Housing (Shells):</b>	Brass with 0.000050 inch [1.27 microns] gold over copper plate.
<b>Mounting Spacers and Brackets:</b>	Brass with 0.000050 inch [1.27 microns] gold over copper plate.
<b>Push-On Fasteners:</b>	Phosphor bronze or beryllium copper with 0.000050 inch [1.27 microns] gold over copper plate.
<b>Jackscrew Systems:</b>	Brass with 0.000050 inch [1.27 microns] gold over copper plate.

### Cable Adapter (Hood):

Brass with 0.000050 inch [1.27 microns] gold over copper plate; aluminum with electroless nickel plate. Other finishes available, contact Technical Sales.

### MECHANICAL CHARACTERISTICS:

#### Contacts:

##### Size 20 Fixed:

Male contact 0.040 inch [1.02 mm] mating diameter. Female contact - PosiBand closed entry design; *see page 1 for details.*

##### Size 20 Removable:

Install contact to rear face of connector insert and remove from rear face of connector insert. Size 20 contact, male contact 0.040 inch [1.02 mm] mating diameter. Female contact - PosiBand closed entry design; *see page 1 for details. For removable size 20 contacts, see pages 79 & 80.*



## TECHNICAL CHARACTERISTICS, *continued*

*continued from previous page. . . .*

### MECHANICAL CHARACTERISTICS, continued:

<b>Contact Retention in Connector Insert:</b>	9 lbs. [40 N].
<b>Resistance to Solder Iron Heat:</b>	650°F [350°C] for 10 seconds duration per IEC 60512-6, solder cup contacts.
<b>Contact Terminations:</b>	Removable, closed barrel crimp - wire sizes 18 AWG [1.0 mm <sup>2</sup> ] through 30 AWG [0.05 mm <sup>2</sup> ]. Removable, closed barrel solder - wire size 20 AWG [0.5 mm <sup>2</sup> ] maximum; see page 80 for details. Fixed, solder cup - wire size 20 AWG [0.5 mm <sup>2</sup> ] maximum; see page 8 for details. Straight solder printed board mount - 0.028 inch [0.71 mm] termination diameter and 0.024 inch [0.61 mm] termination diameter. Right angle (90°) printed board mount - 0.028 inch [0.71 mm] termination diameter for Inch System footprint, and 0.024 inch [0.64 mm] termination diameter for European Metric footprint.
<b>Connector Housing (Shells):</b>	Male connector housings may be dimpled for EMI/ESD ground paths.
<b>Polarization:</b>	Trapezoidally-shaped connector housings and polarized jackscrews.
<b>Mounting to Angle Brackets:</b>	Jackscrews and riveted fasteners with 0.120 inch [3.05 mm] clearance hole, and threaded riveted fasteners with 4-40 thread and polyester lock inserts.

<b>Mounting to Printed Board:</b>	Rapid installation push-on fasteners and mounting posts.
<b>Locking Systems:</b>	Jackscrews.
<b>Mechanical Operations:</b>	1,000 operations minimum per IEC 60512-5.

### ELECTRICAL CHARACTERISTICS:

<b>Contact Current Rating, Tested per UL 1977:</b>	18 amperes, 2 contacts energized. 14 amperes, 6 contacts energized. 11 amperes, 15 contacts energized. 10 amperes, 25 contacts energized. 9 amperes, 50 contacts energized.
--	---

*See temperature rise curves on page 2 for details.*

<b>Initial Contact Resistance:</b>	0.004 ohms, maximum.
<b>Proof Voltage:</b>	1,000 V r.m.s.
<b>Insulation Resistance:</b>	5 G ohms.
<b>Clearance and Creepage Distance:</b>	0.039 inch [1.0 mm], minimum.
<b>Working Voltage:</b>	300 V r.m.s.

### CLIMATIC CHARACTERISTICS:

<b>Temperature Range:</b>	-55°C to +125°C.
<b>Damp Heat, Steady State:</b>	21 days.

Visit our website for the latest catalog updates and supplements at  
<http://www.connectpositronic.com/products/62/HighPerformanceD-subminiature/catalogs/>

## CONTACT VARIANTS

FACE VIEW OF MALE OR REAR VIEW OF FEMALE

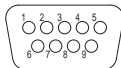

SND 9

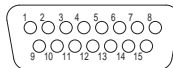

SND 15

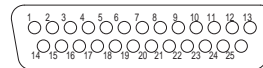

SND 25

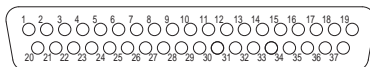

SND 37

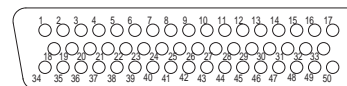

SND 50

For information regarding **REMOVABLE CONTACTS**, see contact illustration drawings and charts on pages 77-85.



Positronic Industries  
connectpositronic.com

# SND SERIES

## MILITARY / SPACE FLIGHT QUALITY

### STANDARD DENSITY FIXED OR REMOVABLE CONTACTS

High  
Performance  
D-sub

## STANDARD CONNECTOR HOUSING (SHELLS) ASSEMBLY

### CRIMP REMOVABLE

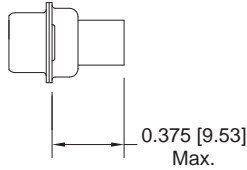

### RECOMMENDED MATING DIMENSIONS

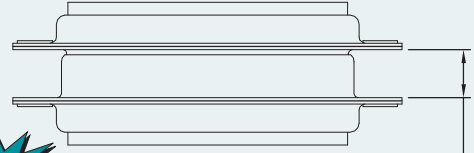

Shell Sizes 1 & 2 =  
0.265±0.015 [6.73±0.38]  
Shell Sizes 3, 4, 5 & 6 =  
0.256±0.015 [6.50±0.38]



### BOARD MOUNT

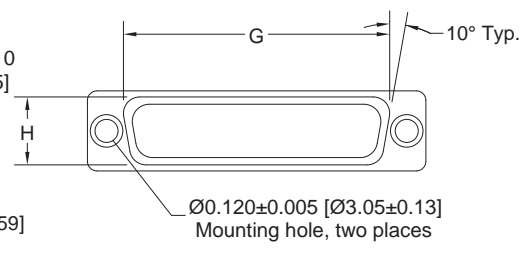
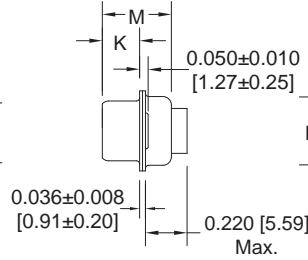
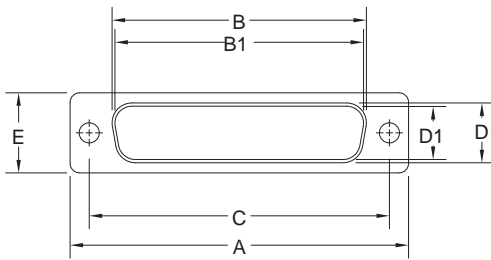

### OPTIONAL CONNECTOR HOUSING ASSEMBLY (0, 02)

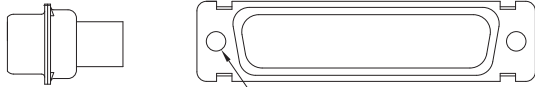

Ø0.120±0.005 [Ø3.05±0.13]  
Mounting hole, two places  
for stainless steel shell (0 option)  
Ø0.154 [3.91] Mounting hole,  
two places (02 option)

### OPTIONAL CONNECTOR HOUSING ASSEMBLY WITH UNIVERSAL FLOAT MOUNTS (F)

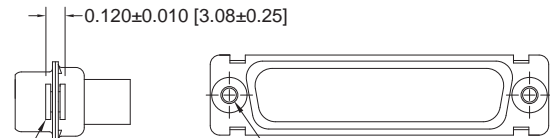

0.120±0.010 [3.08±0.25]  
0.032 [0.81]  
Total diametral float  
Ø0.086<sup>+0.005</sup><sub>-0.000</sub> [Ø2.18<sup>+0.13</sup><sub>-0.00</sub>]  
Mounting hole, two places

CONNECTOR VARIANT SIZES	GENDER	A ±0.015 [0.38]	B ±0.005 [0.13]	B1 ±0.005 [0.13]	C ±0.005 [0.13]	D ±0.005 [0.13]	D1 ±0.005 [0.13]	E ±0.015 [0.38]	G ±0.010 [0.25]	H ±0.010 [0.25]	K ±0.005 [0.13]	M ±0.010 [0.25]
SND 9 (SHELL SIZE 1)	MALE	1.213 [30.81]		0.666 [16.92]	0.984 [24.99]		0.329 [8.36]	0.494 [12.55]	0.759 [19.28]	0.422 [10.72]	0.233 [5.92]	0.422 [10.72]
	FEMALE	1.213 [30.81]	0.643 [16.33]		0.984 [24.99]	0.311 [7.90]		0.494 [12.55]	0.759 [19.28]	0.422 [10.72]	0.243 [6.17]	0.429 [10.90]
SND 15 (SHELL SIZE 2)	MALE	1.541 [39.14]		0.994 [25.25]	1.312 [33.32]		0.329 [8.36]	0.494 [12.55]	1.083 [27.51]	0.422 [10.72]	0.233 [5.92]	0.422 [10.72]
	FEMALE	1.541 [39.14]	0.971 [24.66]		1.312 [33.32]	0.311 [7.90]		0.494 [12.55]	1.083 [27.51]	0.422 [10.72]	0.243 [6.17]	0.429 [10.90]
SND 25 (SHELL SIZE 3)	MALE	2.088 [53.04]		1.534 [38.96]	1.852 [47.04]		0.329 [8.36]	0.494 [12.55]	1.625 [41.28]	0.422 [10.72]	0.230 [5.84]	0.426 [10.82]
	FEMALE	2.088 [53.04]	1.511 [38.38]		1.852 [47.04]	0.311 [7.90]		0.494 [12.55]	1.625 [41.28]	0.422 [10.72]	0.243 [6.17]	0.429 [10.90]
SND 37 (SHELL SIZE 4)	MALE	2.729 [69.32]		2.182 [55.42]	2.500 [63.50]		0.329 [8.36]	0.494 [12.55]	2.272 [57.71]	0.422 [10.72]	0.230 [5.84]	0.426 [10.82]
	FEMALE	2.729 [69.32]	2.159 [54.84]		2.500 [63.50]	0.311 [7.90]		0.494 [12.55]	2.272 [57.71]	0.422 [10.72]	0.243 [6.17]	0.429 [10.90]
SND 50 (SHELL SIZE 5)	MALE	2.635 [66.93]		2.079 [52.81]	2.406 [61.11]		0.441 [11.20]	0.605 [15.37]	2.178 [55.32]	0.534 [13.56]	0.230 [5.84]	0.426 [10.82]
	FEMALE	2.635 [66.93]	2.064 [52.43]		2.406 [61.11]	0.423 [10.74]		0.605 [15.37]	2.178 [55.32]	0.534 [13.56]	0.243 [6.17]	0.429 [10.90]

7 DIMENSIONS ARE IN INCHES [MILLIMETERS].  
ALL DIMENSIONS ARE SUBJECT TO CHANGE.



**SOLDER CUP TERMINATION  
CODE 2**

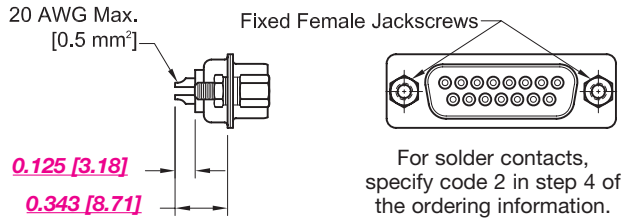

**TYPICAL PART NUMBER:  
SND15M200T2G**

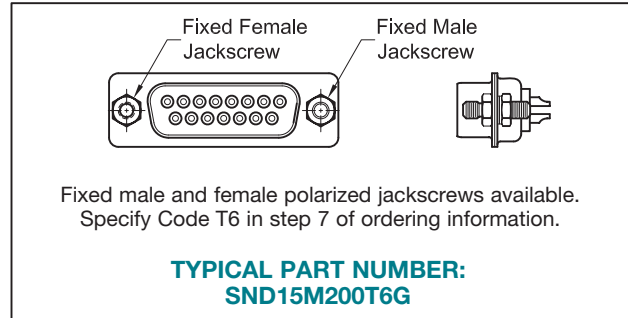

**SND15S5R70T2G**  
(shown left)

**SND25M10H0G**  
(shown middle)

**SND9M000G with  
MC6020M contacts**  
(shown right)

**STRAIGHT SOLDER PRINTED BOARD MOUNT TERMINATION  
CODE 3, 32 AND 36**

*1 CODE NUMBER	L	ØD
3	0.170 [4.32]	0.028 [0.71]
32	0.375 [9.53]	0.028 [0.71]
36	0.236 [6.00]	0.024 [0.61]

**NOTE:**

\*1 Contact termination code as specified in Step 4 of ordering information.

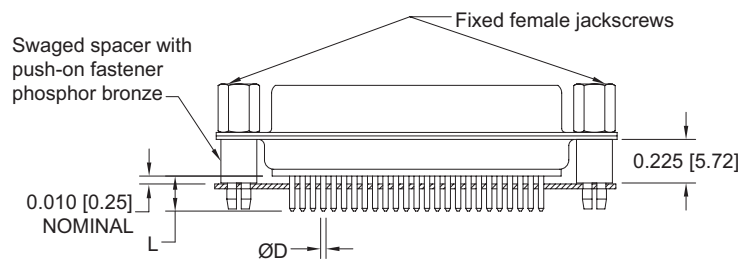

**TYPICAL PART NUMBER:  
SND25S3S60TG**



Positronic Industries  
connectpositronic.com

# SND SERIES

## MILITARY / SPACE FLIGHT QUALITY

### STANDARD DENSITY FIXED OR REMOVABLE CONTACTS

High  
Performance  
D-sub

SND SERIES

### RIGHT ANGLE (90°) PRINTED BOARD MOUNT TERMINATION

#### CODE 42, 0.370 [9.40] CONTACT EXTENSION

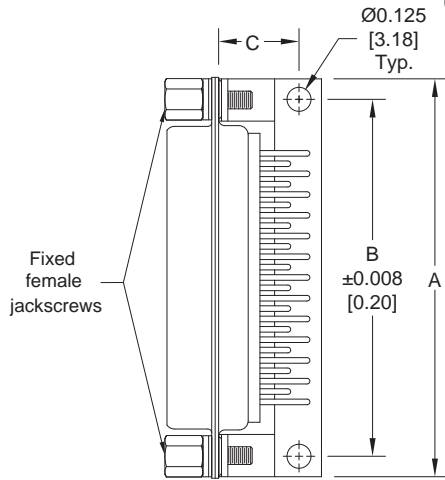

SND**42**** 0.370 [9.40] CONTACT EXTENSION			
PART NUMBER	A	B	C
SND9*42****	1.204 [30.58]	0.984 [24.99]	0.420 [10.67]
SND15*42****	1.532 [38.91]	1.312 [33.32]	0.420 [10.67]
SND25*42****	2.072 [52.63]	1.852 [47.04]	0.420 [10.67]
SND37*42****	2.720 [69.09]	2.500 [63.50]	0.420 [10.67]
SND50*42****	2.626 [66.70]	2.406 [61.11]	0.470 [11.94]

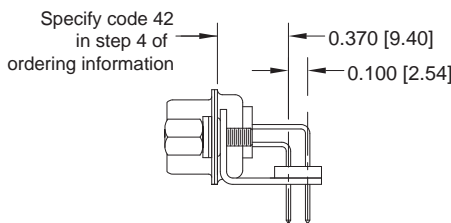

TYPICAL PART NUMBER:  
SND25M42B30T2G

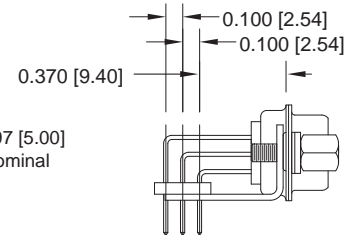
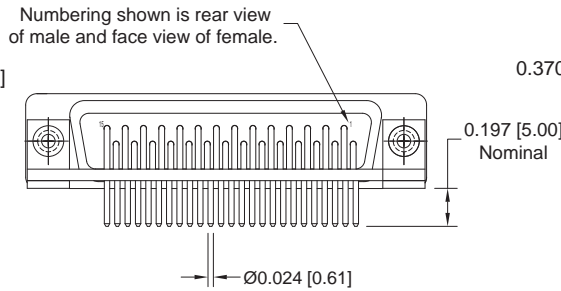

TYPICAL PART NUMBER:  
SND50M42B30TG

### RIGHT ANGLE (90°) PRINTED BOARD MOUNT TERMINATION

#### CODE 5, 0.283 [7.19] CONTACT EXTENSION

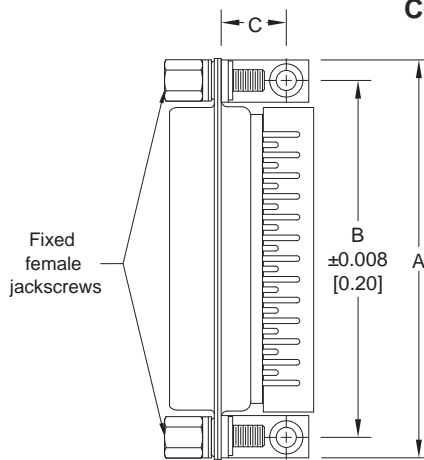

SND**5**** 0.283 [7.19] CONTACT EXTENSION			
PART NUMBER	A	B	C
SND9*5****	1.204 [30.58]	0.984 [24.99]	0.339 [8.61]
SND15*5****	1.532 [38.91]	1.312 [33.32]	0.339 [8.61]
SND25*5****	2.072 [52.63]	1.852 [47.04]	0.339 [8.61]
SND37*5****	2.720 [69.09]	2.500 [63.50]	0.339 [8.61]
SND50*5****	2.626 [66.70]	2.406 [61.11]	0.395 [10.03]

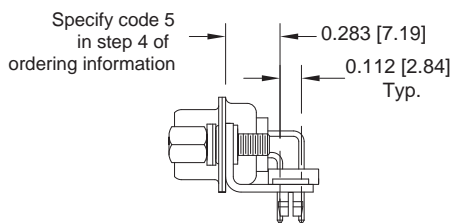

TYPICAL PART NUMBER:  
SND25M5R7NT2G

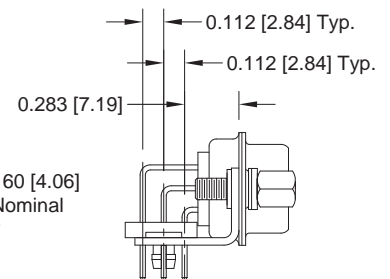
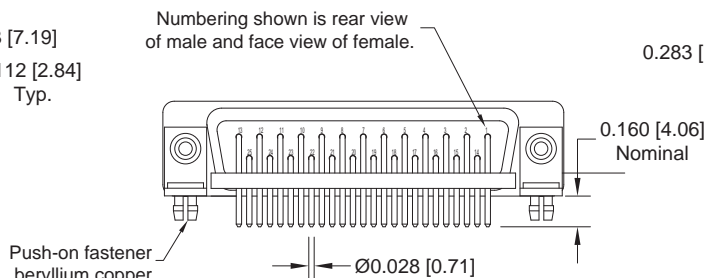

TYPICAL PART NUMBER:  
SND50S5R7NTG





**RIGHT ANGLE (90°) AND STRAIGHT SOLDER PRINTED BOARD CONTACT HOLE PATTERN**

HOLE IDENTIFICATION SHOWN FOR MALE CONNECTOR; USE MIRROR IMAGE FOR FEMALE CONNECTOR.  
MOUNT CONNECTOR WITH MATING FACE POSITIONED TO FOLLOW DIRECTION OF ARROWS.

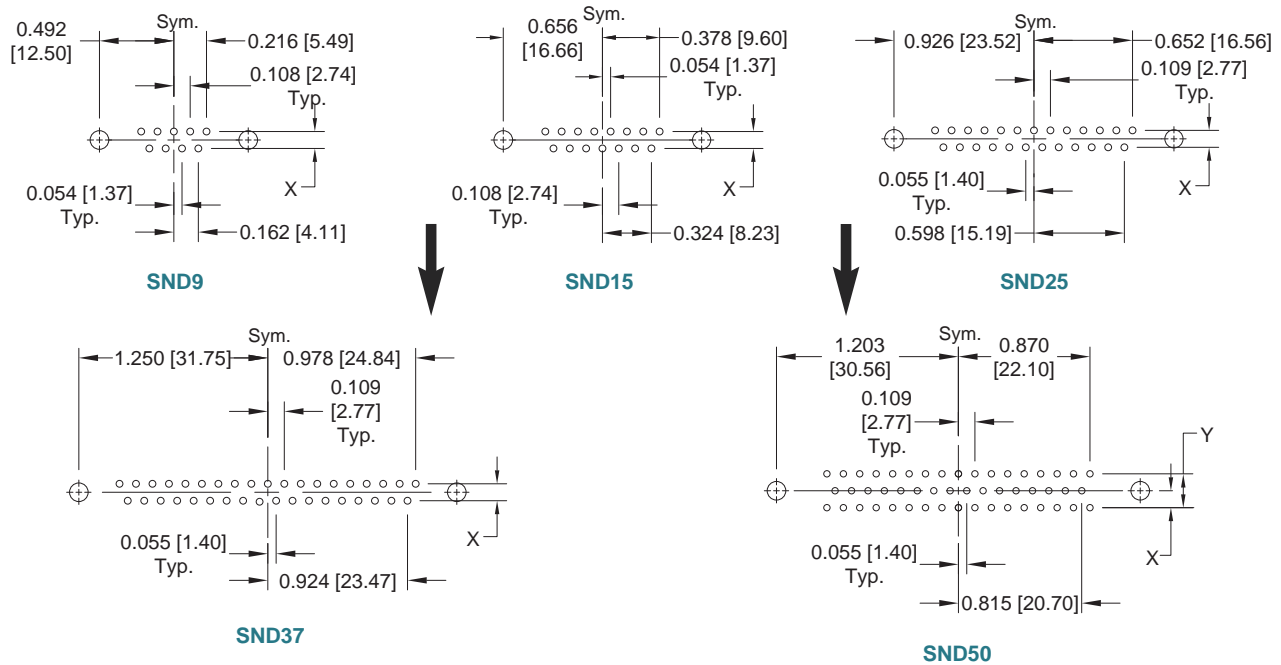

*1 CODE NUMBER	X	Y
3		
5	0.112 [2.84]	0.224 [5.69]
32		
36		
*2 42	0.100 [2.54]	0.200 [5.08]

**NOTE:**

- \*1 Contact termination code as specified in Step 4 of ordering information.
- \*2 Metric system, European contact hole pattern.

**SUGGESTED PRINTED BOARD HOLE SIZES:**

- Suggest 0.039 [0.99] Ø hole for 0.024 [0.61] Ø contact termination positions.
- Suggest 0.045 [1.14] Ø hole for 0.028 [0.71] Ø contact termination positions.
- Suggest 0.123 ±0.003 [3.12 ±0.08] Ø hole for mounting connector with push-on fasteners.



Positronic Industries  
connectpositronic.com

# SND SERIES

## MILITARY / SPACE FLIGHT QUALITY

### STANDARD DENSITY FIXED OR REMOVABLE CONTACTS

High  
Performance  
D-sub

## REMOVABLE CONTACT ORDERING ASSISTANCE CHART



### SND SERIES CRIMP AND SOLDER CONTACT TERMINATIONS

TYPE	PAGE NUMBER REFERENCE IN CATALOG	CONTACT SIZE	FEMALE PART NUMBER	MALE PART NUMBER	WIRE SIZE AWG [mm <sup>2</sup> ]
CRIMP	see page 79 for additional information	20	FC6020M2	MC6020M	20 / 22 / 24 [0.5 / 0.3 / 0.25]
			FC6026M2	MC6026M	26 / 28 / 30 [0.12 / 0.08 / 0.05]
	see page 80 for additional information		FC6018M2	MC6018M	18 [1.0] max.
SOLDER	see page 80 for additional information	20	FS6020M2	MS6020M	20 [0.5] max.

**NOTE:** For ordering crimp contacts on reels, add "R" to part number, see page 77 for details.  
Examples: FC6020M2R or MC6020MR

## The PosiBand® contact system has many advantages over the legacy split tine design.



- X** **PosiBand** is more robust than split tine, which can be pried open in harsh environments, resulting in reduced normal force and degradation of electrical performance.
- X** **PosiBand** has greater surface area at the male and female contact interface, resulting in more consistent electrical performance.
- X** **PosiBand** has lower average insertion forces, resulting in greater ease in mating, especially in larger high density connectors. The average lower insertion force is accomplished while meeting or exceeding performance requirements.
- X** The **PosiBand's** main contact body does not require annealing of the crimp barrels, as does the split tine design. This eliminates concern of unintentionally heat-treating the mating end of the contact, which can cause electrical failure.
- X** **PosiBand** is qualified under **SAE AS39029** specification. **PosiBand** is also qualified under **GSFC S-311-P4** to the higher 40 gram contact engagement test requirement.



FC8022M2. Deconstructed contact shown for reference only.

**For more information on PosiBand closed entry contacts, see page 1 & 2.**

For information regarding **REMOVABLE CONTACTS**, see contact illustration drawings and charts on pages 77-85.

For information regarding **CRIMP TOOLS & CRIMPING TOOL TECHNIQUES**, see page 96.



## ORDERING INFORMATION - CODE NUMBERING SYSTEM

Specify Complete Connector By Selecting An Option From Step 1 Through 8

STEP	1	2	3	4	5	6	7	8	9
EXAMPLE	SND	37	S	5	B3	0	T2	G	—

### STEP 1 - BASIC SERIES

SND series

### STEP 2 - CONNECTOR VARIANTS

9, 15, 25, 37, 50

### STEP 3 - CONNECTOR GENDER

- M - Male
- S - Female - PosiBand closed entry contacts, see page 1 for more information.

### STEP 4 - CONTACT TERMINATION TYPE

- 0 - Contacts ordered separately, see contact chart on page 11 for details.
- 1 - Crimp, 20 AWG - 24 AWG [0.5 mm<sup>2</sup> - 0.25 mm<sup>2</sup>].
- 12 - Crimp, 26 AWG - 30 AWG [0.12 mm<sup>2</sup> - 0.05 mm<sup>2</sup>].
- 2 - Fixed, solder cup.
- 3 - Solder, straight printed board mount with 0.170 [4.32] tail length.
- 32 - Solder, straight printed board mount with 0.375 [9.52] tail length.
- 36 - Solder, straight printed board mount with 0.236 [5.99] tail length.
- 42 - Solder, metric system right angle (90°) printed board mount with 0.370 [9.40] contact extension.
- 5 - Solder, right angle (90°) printed board mount with 0.283 [7.19] contact extension.

### \*1 STEP 5 - MOUNTING STYLE

- 0 - Mounting hole, 0.120[3.05] Ø.
- 02 - Mounting hole, 0.154[3.91] Ø.
- C5 - Swaged spacer, cul-de-sac style, 4-40 threads, 0.350 [8.89] length. For use with cable connectors only.
- C7 - Bracket, mounting, right angle (90°) metal, swaged to connector with cul-de-sac spacer and 4-40 threads with cross bar.
- F - Float mounts, universal.
- P - Threaded post, brass, length varies according to contact termination code. See page 89.
- R2 - Bracket, mounting, right angle (90°) metal, swaged to connector with 4-40 thread fixed female jackscrews with cross bar.
- R6 - Bracket, mounting, right angle (90°) metal, swaged to connector with 0.120 [3.05] Ø mounting hole with cross bar.
- R7 - Bracket, mounting, right angle (90°) metal, swaged to connector with 4-40 threads with cross bar.
- R8 - Bracket, mounting, right angle (90°) metal, swaged to connector with 4-40 locknut with cross bar.
- S - Swaged spacer, 4-40 threads, length varies according to contact termination code. See page 88.
- S2 - Swaged spacer, 4-40 threads, 0.125[3.18] length.
- S5 - Swaged locknut, 4-40 threads.
- S6 - Swaged spacer with push-on fastener, 4-40 threads, length varies according to contact termination code. See page 88.

### STEP 9 - SPECIAL OPTIONS

SEE APPENDIX ON PAGE 95.

### STEP 8 - CONNECTOR HOUSING (SHELLS) OPTIONS

- G - Gold over copper plate.
- D - Gold over copper plate and dimpled (male connectors only).

### \*1 STEP 7 - LOCKING AND POLARIZING SYSTEMS

- 0 - None.
- T - Fixed female jackscrews.
- T2 - Fixed female jackscrews.
- T6 - Fixed male and female polarized jackscrews.
- E - Rotating male jackscrews.
- E2 - Rotating male screw locks.
- E3 - Rotating male with internal hex for 3/32 hex drives.
- E6 - Rotating male and female polarized jackscrews.

### \*1 STEP 6 - CABLE ADAPTER (HOOD) AND PUSH-ON FASTENER

- 0 - None.
- H - Cable adapter, top opening, brass.
- AN - Cable adapter, lightweight aluminum, electroless nickel plate, see page 91 for details.
- N - Push-on fastener for right angle (90°) mounting brackets.

### NOTE:

\*1 For additional information on accessories listed in Step 5, 6, and 7, see the Accessories section, pages 86-94.

*Do you need 2-D drawings  
or 3-D models?  
See page 18 for more information!*

For information regarding CRIMP TOOLS & CRIMPING TOOL TECHNIQUES, see page 96.



Positronic Industries  
connectpositronic.com

# SDD SERIES

## MILITARY / SPACE FLIGHT QUALITY

### HIGH DENSITY REMOVABLE OR PCB CONTACTS

High  
Performance  
D-sub



High performance for use in harsh environments, including space flight.

Size 22 **fixed or removable** contacts.

Female closed entry contacts utilize the “PosiBand®” system. *See page 1 for details.*  
GSFC S-311-P-4/08 offers two contact engagement test options. Size 22 PosiBand contacts meet the higher 40 gram requirements per 4.2.2.b.

Six connector variants include 15, 26, 44, 62, 78, and 104 contacts.

Terminations include cable or wire crimp and solder, straight and right angle PCB mount.

Current ratings: signal level to 12 amperes.  
*See temperature rise curves on page 2 for details.*

A wide variety of options and accessories.

Applicable variants are qualified to GSFC and military specifications. *See page 98 for details.*

### Conforming To Applicable Material, Dimensional and Performance Requirements:

- GSFC S-311-P4
- MIL-DTL-24308 Class M

### Conforming To Outgassing Requirements:

- ASTM E-595 & NASA-RP-1124

## T E C H N I C A L C H A R A C T E R I S T I C S

### MATERIALS AND FINISHES:

**Connector Insert:** Glass-filled polyester per ASTM-D-5927, UL 94V-0, ASTM E-595, NASA-RP-1124, blue color.

**Contacts:** Precision machined high tensile copper alloy. 0.000050 inch [1.27 microns] gold over copper plate. Other finishes are available; see page 95.

**Connector Housing (Shells):** Brass with 0.000050 inch [1.27 microns] gold over copper plate.

**Mounting Spacers and Brackets:** Brass with 0.000050 inch [1.27 microns] gold over copper plate.

**Push-On Fasteners:** Phosphor bronze or beryllium copper with 0.000050 inch [1.27 microns] gold over copper plate.

**Jackscrew Systems:** Brass with 0.000050 inch [1.27 microns] gold over copper plate.

**Cable Adapter (Hood):** Brass with 0.000050 inch [1.27 microns] gold over copper plate; aluminum with electroless nickel plate. Other finishes available, contact Technical Sales.

### MECHANICAL CHARACTERISTICS:

**Contacts:**  
**Size 22 Fixed:** Male contact 0.030 inch [0.76 mm] mating diameter. Female contact - PosiBand closed entry design; *see page 1 for details.*

**Size 22 Removable:** Install contact to rear face of connector insert and remove from rear face of connector insert. Male contact - 0.030 inch [0.76 mm] mating diameter. Female contact - PosiBand closed entry design; *see page 1 for details. For removable size 22 contacts, see page 78-79.*



## TECHNICAL CHARACTERISTICS, *continued*

*continued from previous page. . .*

### MECHANICAL CHARACTERISTICS, continued:

<b>Contact Retention in Connector Insert:</b>	9 lbs. [40 N].
<b>Contact Terminations:</b>	Removable closed barrel crimp - wire sizes 20 AWG [0.5 mm <sup>2</sup> ] through 30 AWG [0.05 mm <sup>2</sup> ]. 0.020 inch [0.51 mm] diameter. Removable, closed barrel solder - wire size 22 AWG [0.3 mm <sup>2</sup> ] maximum; see page 79 for details. Straight solder printed board mount - 0.020 inch [0.51 mm] termination diameter. Right angle (90°) printed board mount - 0.020 inch [0.51 mm] termination diameter.
<b>Connector Housing (Shells):</b>	Male connector housings may be dimpled for EMI/ESD ground paths.
<b>Polarization:</b>	Trapezoidally-shaped connector housings and polarized jackscrews.
<b>Mounting to Angle Brackets:</b>	Jackscrews and riveted fasteners with 0.120 inch [3.05 mm] clearance hole, and threaded fasteners with 4-40 threads and polyester lock inserts.
<b>Mounting to Printed Board:</b>	Rapid installation push-on fasteners and mounting posts.
<b>Locking Systems:</b>	Jackscrews.
<b>Mechanical Operations:</b>	1,000 operations, minimum, per IEC 60512-5.

### ELECTRICAL CHARACTERISTICS:

#### Contact Current Rating, Tested per UL 1977:

12 amperes, 2 contacts energized.
10 amperes, 6 contacts energized.
7.5 amperes, 26 contacts energized.
6.5 amperes, 65 contacts energized.
5.0 amperes, 104 contacts energized.

*See temperature rise curves on page 2 for details.*

<b>Initial Contact Resistance:</b>	0.005 ohms, maximum.
<b>Proof Voltage:</b>	1,000 V r.m.s.
<b>Insulation Resistance:</b>	5 G ohms.
<b>Clearance and Creepage</b>	
<b>Distance:</b>	0.042 inch [1.06 mm], minimum.
<b>Working Voltage:</b>	300 V r.m.s.

### CLIMATIC CHARACTERISTICS:

<b>Temperature Range:</b>	-55°C to +125°C.
<b>Damp Heat, Steady State:</b>	21 days.

Visit our website for the latest catalog updates and supplements at  
<http://www.connectpositronic.com/products/62/HighPerformanceD-subminiature/catalogs/>

## CONTACT VARIANTS

FACE VIEW OF MALE OR REAR VIEW OF FEMALE

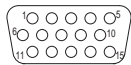

SDD 15

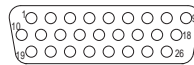

SDD 26

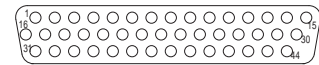

SDD 44

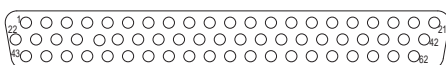

SDD 62

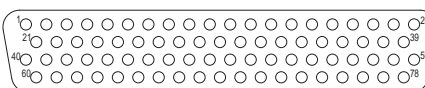

SDD 78

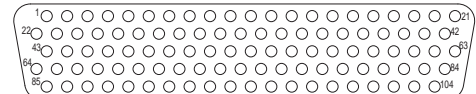

SDD 104

For information regarding **REMOVABLE CONTACTS**, see contact illustration drawings and charts on pages 77-85.



Positronic Industries  
connectpositronic.com

# SDD SERIES

## MILITARY / SPACE FLIGHT QUALITY

### HIGH DENSITY REMOVABLE OR PCB CONTACTS

High  
Performance  
D-sub

### STANDARD CONNECTOR HOUSING (SHELLS) ASSEMBLY



SDD78M0000D

SDD15S0000G

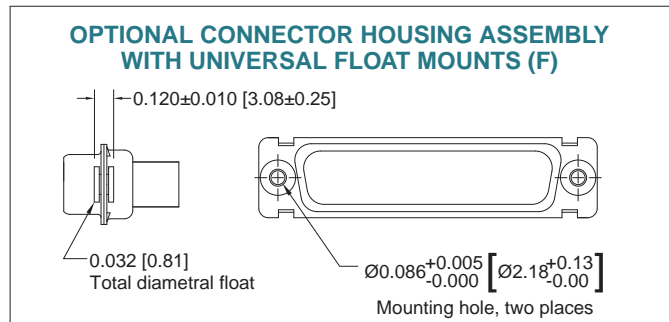
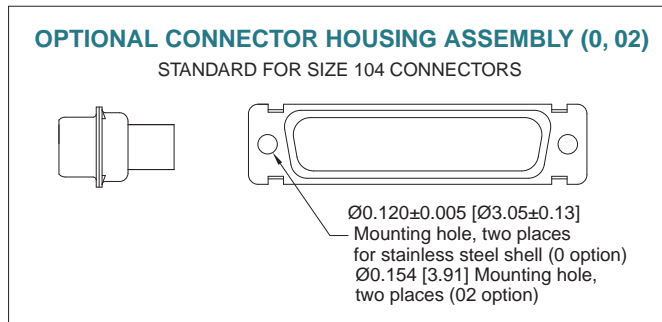
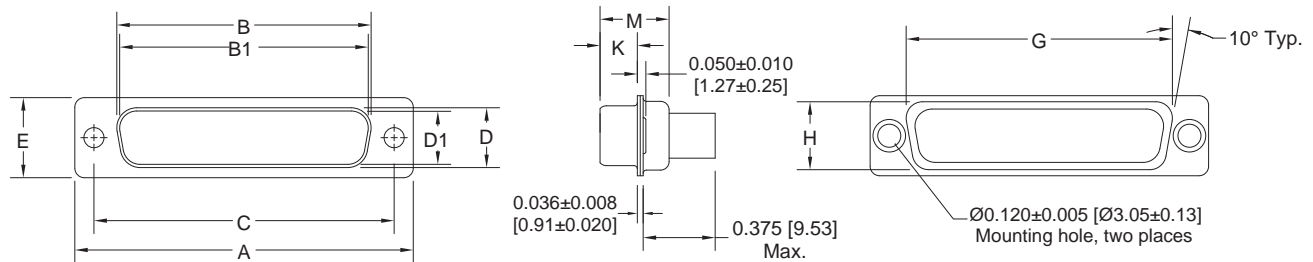
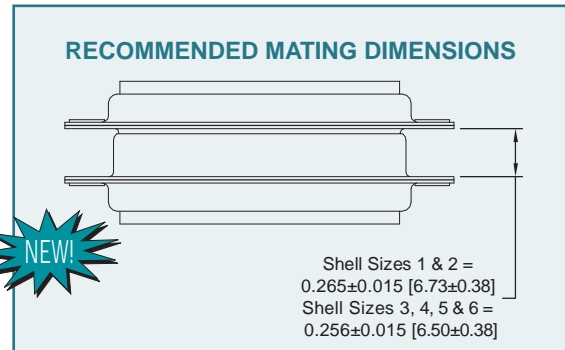

CONNECTOR VARIANT SIZES	GENDER	A ±0.015 [0.38]	B ±0.005 [0.13]	B1 ±0.005 [0.13]	C ±0.005 [0.13]	D ±0.005 [0.13]	D1 ±0.005 [0.13]	E ±0.015 [0.38]	G ±0.010 [0.25]	H ±0.010 [0.25]	K ±0.005 [0.13]	M ±0.010 [0.25]
SDD 15 (SHELL SIZE 1)	MALE	1.213 [30.81]		0.666 [16.92]	0.984 [24.99]		0.329 [8.36]	0.494 [12.55]	0.759 [19.28]	0.422 [10.72]	0.233 [5.92]	0.422 [10.72]
	FEMALE	1.213 [30.81]	0.643 [16.33]		0.984 [24.99]	0.311 [7.90]		0.494 [12.55]	0.759 [19.28]	0.422 [10.72]	0.243 [6.17]	0.429 [10.90]
SDD 26 (SHELL SIZE 2)	MALE	1.541 [39.14]		0.994 [25.25]	1.312 [33.32]		0.329 [8.36]	0.494 [12.55]	1.083 [27.51]	0.422 [10.72]	0.233 [5.92]	0.422 [10.72]
	FEMALE	1.541 [39.14]	0.971 [24.66]		1.312 [33.32]	0.311 [7.90]		0.494 [12.55]	1.083 [27.51]	0.422 [10.72]	0.243 [6.17]	0.429 [10.90]
SDD 44 (SHELL SIZE 3)	MALE	2.088 [53.04]		1.534 [38.96]	1.852 [47.04]		0.329 [8.36]	0.494 [12.55]	1.625 [41.28]	0.422 [10.72]	0.230 [5.84]	0.426 [10.82]
	FEMALE	2.088 [53.04]	1.511 [38.38]		1.852 [47.04]	0.311 [7.90]		0.494 [12.55]	1.625 [41.28]	0.422 [10.72]	0.243 [6.17]	0.429 [10.90]
SDD 62 (SHELL SIZE 4)	MALE	2.729 [69.32]		2.182 [55.42]	2.500 [63.50]		0.329 [8.36]	0.494 [12.55]	2.272 [57.71]	0.422 [10.72]	0.230 [5.84]	0.426 [10.82]
	FEMALE	2.729 [69.32]	2.159 [54.84]		2.500 [63.50]	0.311 [7.90]		0.494 [12.55]	2.272 [57.71]	0.422 [10.72]	0.243 [6.17]	0.429 [10.90]
SDD 78 (SHELL SIZE 5)	MALE	2.635 [66.93]		2.079 [52.81]	2.406 [61.11]		0.441 [11.20]	0.605 [15.37]	2.178 [55.32]	0.534 [13.56]	0.230 [5.84]	0.426 [10.82]
	FEMALE	2.635 [66.93]	2.064 [52.43]		2.406 [61.11]	0.423 [10.74]		0.605 [15.37]	2.178 [55.32]	0.534 [13.56]	0.243 [6.17]	0.429 [10.90]
SDD 104 (SHELL SIZE 6)	MALE	2.729 [69.32]		2.212 [56.18]	2.500 [63.50]		0.503 [12.78]	0.668 [16.97]	2.302 [58.47]	0.596 [15.14]	0.230 [5.84]	0.426 [10.82]
	FEMALE	2.729 [69.32]	2.189 [55.60]		2.500 [63.50]	0.485 [12.32]		0.668 [16.97]	2.302 [58.47]	0.596 [15.14]	0.243 [6.17]	0.429 [10.90]

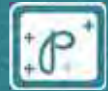

**STRAIGHT SOLDER PRINTED BOARD MOUNT TERMINATION**  
**CODE 3 AND 32**

*1 CODE NUMBER	L
3	0.150 [3.81]
32	0.300 [7.62]

**NOTE:**

\*1 Contact termination code as specified in Step 4 of ordering information.

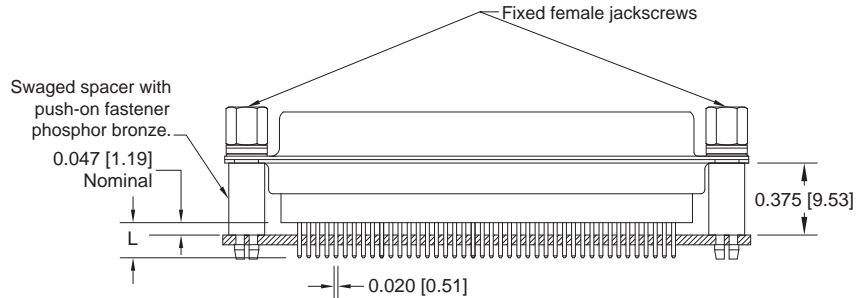

**TYPICAL PART NUMBER:**  
**SDD62S3S60T2G**

**RIGHT ANGLE (90°) PRINTED BOARD MOUNT TERMINATION**  
**CODE 4, 0.450 [11.43] CONTACT EXTENSION**

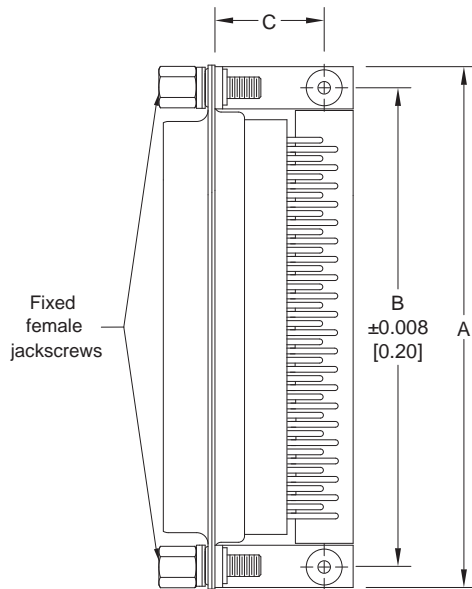

SDD**4*** 0.450 [11.43] CONTACT EXTENSION			
PART NUMBER	A	B	C
SDD15*4****	1.204 [30.58]	0.984 [24.99]	0.528 [13.41]
SDD26*4****	1.532 [38.91]	1.312 [33.32]	0.528 [13.41]
SDD44*4****	2.072 [52.63]	1.852 [47.04]	0.528 [13.41]
SDD62*4****	2.720 [69.09]	2.500 [63.50]	0.528 [13.41]
SND50*5****	2.626 [66.70]	2.406 [61.11]	0.573 [14.55]
SDD104*4****	2.720 [69.09]	2.500 [63.50]	0.614 [15.60]

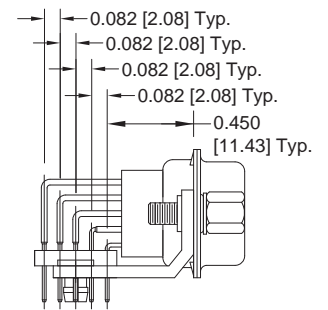

**TYPICAL PART NUMBER:**  
**SDD104M4R7NT2G**

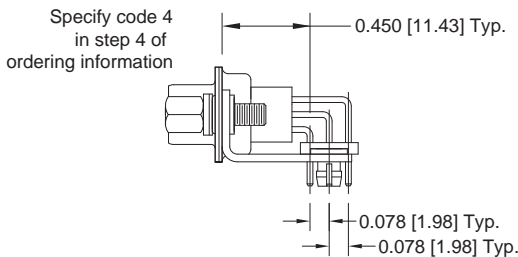

**TYPICAL PART NUMBER:**  
**SDD44S4R7NT2G**

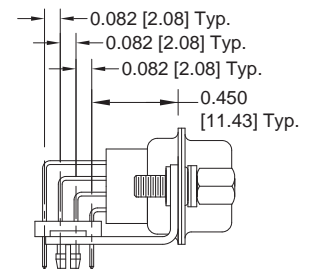
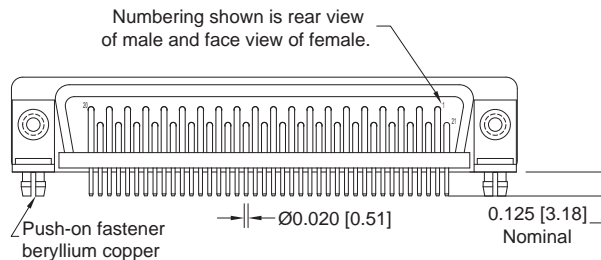

**TYPICAL PART NUMBER:**  
**SDD78M4R7NT2G**



Positronic Industries  
connectpositronic.com

# SDD SERIES

## MILITARY / SPACE FLIGHT QUALITY

### HIGH DENSITY REMOVABLE OR PCB CONTACTS

High  
Performance  
D-sub

## RIGHT ANGLE (90°) AND STRAIGHT SOLDER PRINTED BOARD CONTACT HOLE PATTERN

MOUNT CONNECTOR WITH MATING FACE POSITIONED TO FOLLOW DIRECTION OF ARROWS.

**SDD15 MALE**

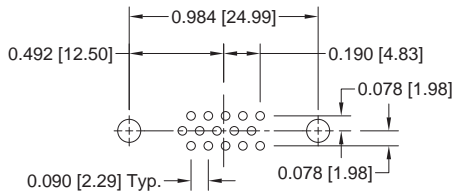

**SDD15 FEMALE**

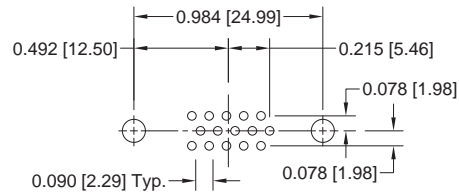

**SDD26 MALE**

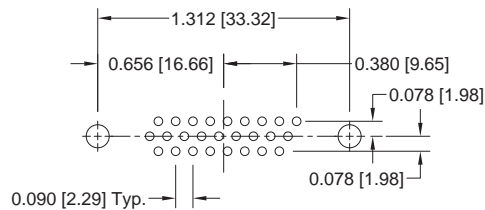

**SDD26 FEMALE**

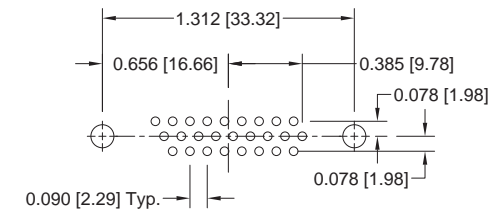

**SDD44 MALE**

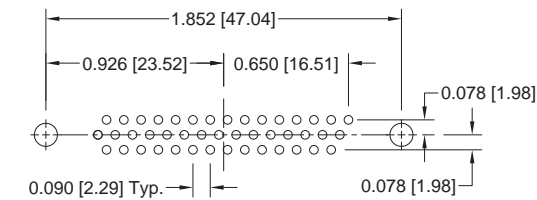

**SDD44 FEMALE**

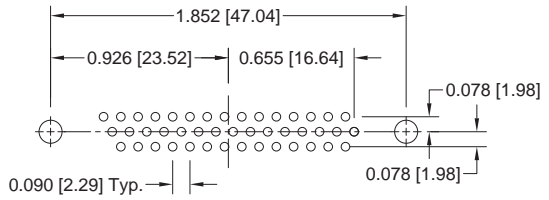

**SDD62 MALE**

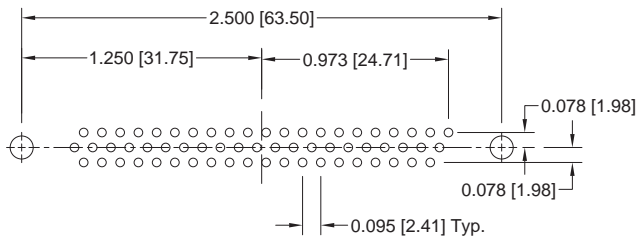

**SDD62 FEMALE**

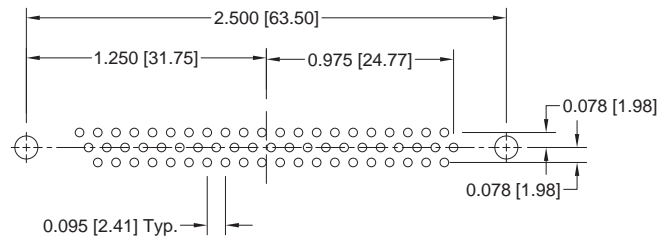

**SDD78 MALE**

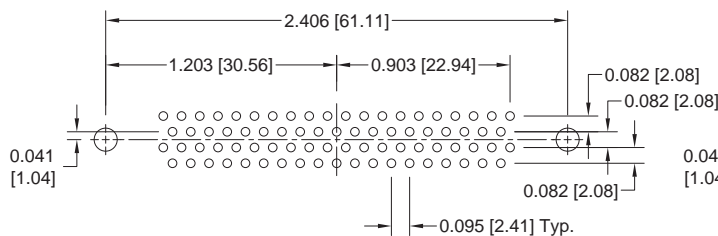

**SDD78 FEMALE**

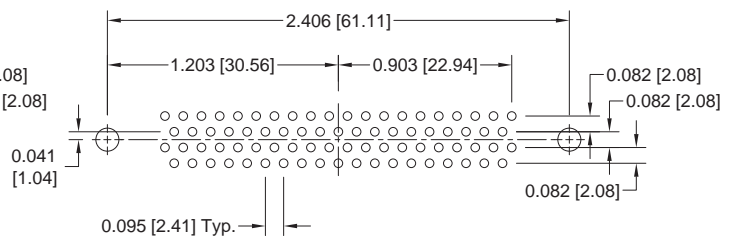

**SDD104 MALE**

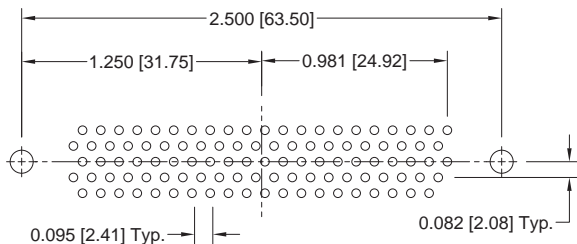

**SDD104 FEMALE**

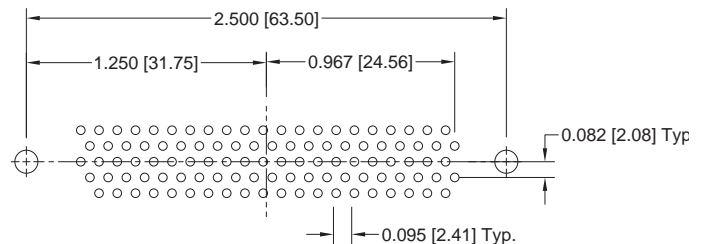

### SUGGESTED PRINTED BOARD HOLE SIZES:

Suggest 0.035 [0.89] Ø hole for contact termination positions.  
Suggest 0.123 ±0.003 [3.12 ±0.08] Ø hole for mounting connector with push-on fasteners.





## REMOVABLE CONTACT ORDERING ASSISTANCE CHART



### SDD SERIES CRIMP AND SOLDER CONTACT TERMINATIONS

TYPE	PAGE NUMBER REFERENCE IN CATALOG	CONTACT SIZE	FEMALE PART NUMBER	MALE PART NUMBER	WIRE SIZE AWG [mm <sup>2</sup> ]
CRIMP	see page 78 for additional information	22	FC8020M2	MC8020M	20 [0.5] max.
			FC8022M2	MC8022M	22 / 24 / 26 / 28 / 30 [0.3 / 0.25 / 0.12 / 0.08 / 0.05]
SOLDER	see page 79 for additional information	22	FS8022M2	MS8022M	22 [0.3] max.

**NOTE:** For ordering crimp contacts on reels, add "R" to part number, see page 77 for details.  
Examples: FC8022M2R or MC8022MR

For information regarding **REMOVABLE CONTACTS**, see contact illustration drawings and charts on pages 77-85.

For information regarding **CRIMP TOOLS & CRIMPING TOOL TECHNIQUES**, see page 96.

## Do you need 2-D drawings or 3-D models?

Once you have made a connector selection, contact Technical Sales if you would like a 2-D drawing or 3-D model. If we do not have your specific part number on file, we can create one for you. Or use the search function on our web site, [www.connectpositronic.com](http://www.connectpositronic.com).

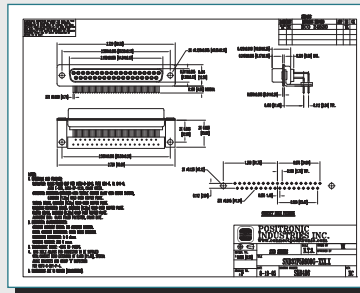

2-D Drawing

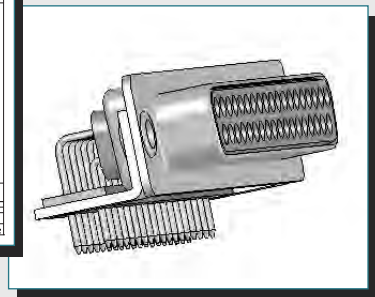

3-D Model



## ORDERING INFORMATION - CODE NUMBERING SYSTEM

Specify Complete Connector By Selecting An Option From Step 1 Through 8

STEP	1	2	3	4	5	6	7	8	9
EXAMPLE	SDD	62	S	4	R7	N	T6	G	—

### STEP 1 - BASIC SERIES

SDD series

### STEP 2 - CONNECTOR VARIANTS

15, 26, 44, 62, 78, 104

### STEP 3 - CONNECTOR GENDER

- M - Male
- S - Female - PosiBand closed entry contacts, see page 1 for more information.

### STEP 4 - CONTACT TERMINATION TYPE

- 0 - Contacts ordered separately, see contact chart on page 18.
- 1 - Crimp, 22 AWG - 30 AWG [0.3 mm<sup>2</sup> - 0.05 mm<sup>2</sup>].
- 3 - Solder, straight printed board mount with 0.150 [3.81] tail length.
- 32 - Solder, straight printed board mount with 0.300 [7.62] tail length.
- 4 - Solder, right angle (90°) printed board mount with 0.450[11.43] Contact Extension.

### \*1 STEP 5 - MOUNTING STYLE

- 0 - Mounting hole, 0.120[3.05] Ø.
- 02 - Mounting hole, 0.154[3.91] Ø.
- B3 - Bracket, mounting, right angle (90°) metal with cross bar.
- C5 - Swaged spacer, cul-de-sac style, 4-40 threads, 0.350 [8.89] length. For use with cable connectors only.
- C7 - Bracket, mounting, right angle (90°) metal, swaged to connector with cul-de-sac spacer and 4-40 threads with cross bar.
- F - Float mounts, universal.
- P - Threaded post, brass, 0.375 [9.53] length.
- R2 - Bracket, mounting, right angle (90°) metal, swaged to connector with 4-40 thread fixed female jackscrews with cross bar.
- R6 - Bracket, mounting, right angle (90°) metal, swaged to connector with 0.120 [3.05] Ø mounting hole with cross bar.
- R7 - Bracket, mounting, right angle (90°) metal, swaged to connector with 4-40 threads with cross bar.
- R8 - Bracket, mounting, right angle (90°) metal, swaged to connector with 4-40 locknut with cross bar.
- S - Swaged spacer, 4-40 threads, 0.375[9.53] length.
- S2 - Swaged spacer, 4-40 threads, 0.125[3.18] length.
- S5 - Swaged locknut, 4-40 threads.
- S6 - Swaged spacer with push-on fastener, 4-40 threads, 0.375[9.53] length.

### STEP 9 - SPECIAL OPTIONS

SEE APPENDIX ON PAGE 95.

### STEP 8 - CONNECTOR HOUSING (SHELLS) OPTION

- G - Gold over copper plate.
- D - Gold over copper plate and dimpled (male connectors only).

### \*1 STEP 7 - LOCKING AND POLARIZING SYSTEMS

- 0 - None.
- T - Fixed female jackscrews.
- T2 - Fixed female jackscrews.
- T6 - Fixed male and female polarized jackscrews.
- E - Rotating male jackscrews.
- E2 - Rotating male screw locks.
- E3 - Rotating male with internal hex for 3/32 hex drives.
- E6 - Rotating male and female polarized jackscrews.

### \*1 STEP 6 - CABLE ADAPTER (HOOD) AND PUSH-ON FASTENER

- 0 - None.
- H - Cable adapter, top opening, brass.
- AN - Cable adapter, lightweight aluminum, electroless nickel plate, see page 91 for details.
- N - Push-on fastener for right angle (90°) mounting brackets.

### NOTE:

\*1 For additional information on accessories listed in Step 5, 6, and 7, see the Accessories section, pages 86-94.

*Do you need 2-D drawings  
or 3-D models?*

See page 18 for more information!

For information regarding CRIMP TOOLS & CRIMPING TOOL TECHNIQUES, see page 96.



- ✓ High performance for use in harsh environments, including space flight.
- ✓ Size 20 **fixed** and Size 8 **removable** contacts.
- ✓ All female closed entry signal contacts utilize the “PosiBand®” system. *See page 1 for details.* GSFC S-311-P-4/10 offers two contact engagement test options. Size 20 PosiBand contacts meet the higher 40 gram requirements per 4.2.2.b.
- ✓ Twenty-two connector variants with a mixture of signal, power, shielded and high voltage contacts.
- ✓ Terminations include cable or wire crimp and solder, straight and right angle PCB mount.
- ✓ Current ratings to 70 amperes.  
*See temperature rise curves on page 3 & 4 for details.*
- ✓ A wide variety of options and accessories.
- ✓ Applicable variants are qualified to GSFC and military specifications. *See page 98 for details.*

**Conforming To Applicable  
Material, Dimensional and  
Performance Requirements:**

- GSFC S-311-P4 & GSFC S-311-P10
- DSCC Specification 85039

**Conforming To Outgassing  
Requirements:**

- ASTM E-595 & NASA-RP-1124

SCBM SERIES

TECHNICAL CHARACTERISTICS

**MATERIALS AND FINISHES:**

<b>Connector Insert:</b>	Glass-filled polyester per ASTM-D-5927, UL 94V-0, ASTM E-595, NASA-RP-1124, blue color.
<b>Contacts:</b>	
<b>Size 20:</b>	Precision machined copper alloy. 0.000050 inch [1.27 microns] gold over copper plate. Other finishes are available; see page 95.
<b>Size 8:</b>	
<b>Power:</b>	Precision machined high conductivity copper alloy. 0.000050 inch [1.27 microns] gold over copper plate. Other finishes are available; see page 95.
<b>Shielded:</b>	<i>For material and finishes, see page 77.</i>
<b>High Voltage:</b>	<i>For material and finishes, see page 77.</i>

<b>Connector Housing (Shells):</b>	Brass with 0.000050 inch [1.27 microns] gold over copper plate.
<b>Mounting Spacers and Brackets:</b>	Brass with 0.000050 inch [1.27 microns] gold over copper plate.
<b>Push-On Fasteners:</b>	Phosphor bronze or beryllium copper with 0.000050 inch [1.27 microns] gold over copper plate.
<b>Jackscrew Systems:</b>	Brass with 0.000050 inch [1.27 microns] gold over copper plate.
<b>Cable Adapter (Hood):</b>	Brass with 0.000050 inch [1.27 microns] gold over copper plate; aluminum with electroless nickel plate. Other finishes available, contact Technical Sales.

*continued on next page. . .*



## TECHNICAL CHARACTERISTICS, *continued*

*continued from previous page. . .*

### MECHANICAL CHARACTERISTICS:

#### Contacts:

**Size 20 Fixed:** Male contact - 0.040 inch [1.02 mm] mating diameter. Female contact - PosiBand closed entry design; *see page 1 for details.*

**Size 8 Removable: Power:** Install contact to rear face of connector insert and remove from front face of connector insert. Male contact - 0.142 inch [3.61 mm] mating diameter. Female contact - features Large Surface Area (L.S.A.) closed entry design utilizing BeCu mechanical retention member. *For removable size 8 contacts, see pages 81-85.*

**Shielded:** *For mechanical characteristics, see page 77.*

**High Voltage:** *For mechanical characteristics, see page 77.*

#### Contact Retention in Connector Insert:

**Size 20:** 9 lbs. [40N].  
**Size 8 Power / Shielded:** 22 lbs. [98N].

**Resistance to Solder Iron Heat:** 500°F [260°C] for 10 seconds duration per IEC 60512-6.

#### Contact Terminations:

**Size 20:** Solder cup - wire size 20 AWG [0.5 mm<sup>2</sup>] maximum; *see page 24 for details.*  
Straight solder printed board mount - 0.028 inch [0.71 mm] termination diameter.  
Right angle (90°) printed board mount - 0.028 inch [0.71 mm] termination diameter.

**Size 8 Power:** Closed barrel crimp or solder cup - wire sizes 8 [10.0 mm<sup>2</sup>], 10 [4.3 mm<sup>2</sup>], 12 [4.0 mm<sup>2</sup>], and 16 [1.5 mm<sup>2</sup>] AWG.  
Straight solder printed board mount - 0.078 inch [1.98 mm], 0.094 inch [2.39 mm] and 0.125 inch [3.18 mm] termination diameters.

Right angle (90°) printed board mount - 0.078 inch [1.98 mm] and 0.125 inch [3.18 mm] termination diameters.

**Shielded:** *Refer to RF Cable in chart on page 84 for contact terminations.*

**High Voltage:** Straight and right angle (90°) terminations - 0.041 inch [1.04 mm] minimum hole diameter.

#### Connector Housing (Shells):

Male connector housings may be dimpled for EMI/ESD ground paths.

#### Polarization:

Trapezoidally-shaped connector housing and polarized jackscrews.

#### Mounting to Angle Brackets:

Jackscrews and riveted fasteners with 0.120 inch [3.05 mm] diameter hole, and threaded riveted fasteners with 4-40 threads and polyester inserts.

#### Mounting to Printed Board:

Rapid installation push-on fasteners and threaded posts.

#### Locking Systems:

Jackscrews.

#### Mechanical Operations:

1,000 operations per IEC 60512-5.

### ELECTRICAL CHARACTERISTICS:

#### SIZE 20 CONTACTS

**Contact Current Rating:** 7.5 amperes, nominal  
**Initial Contact Resistance:** 0.005 ohms maximum.  
**Proof Voltage:** 1000 V r.m.s.

#### SIZE 8 CONTACTS

##### POWER CONTACTS

**Contact Current Rating - Tested per U.L. 1977:**  
**0.078 inches diameter / 12 AWG terminations:** 39 amperes.  
**0.094 inches diameter / 10 AWG terminations:** 50 amperes.  
**0.125 inches diameter / 8 AWG terminations:** 70 amperes.

*See Temperature Rise Curves on page 3 for details.*

**Initial Contact Resistance:** 0.0005 ohms max. per IEC 60512-2, Test 2b.

##### SHIELDED CONTACTS

*For electrical characteristics, see page 77.*

##### HIGH VOLTAGE CONTACTS

*For electrical characteristics, see page 77.*

#### CONNECTOR

**Insulation Resistance:** 5 G ohms.  
**Clearance and Creepage Distance:** 0.039 inch [1.0 mm], minimum.  
**Working Voltage:** 300 V r.m.s.

### CLIMATIC CHARACTERISTICS:

**Temperature Range:** -55°C to +125°C.  
**Damp Heat, Steady State:** 21 days.

Visit our website for the latest catalog updates and supplements at  
<http://www.connectpositronic.com/products/62/HighPerformanceD-subminiature/catalogs/>



**CONTACT VARIANTS**

FACE VIEW OF MALE OR REAR VIEW OF FEMALE

— SHELL SIZE 1 —



\*1 2WK2



5W1

— SHELL SIZE 2 —



3W3



\*2 3WK3

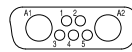

7W2

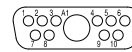

11W1

— SHELL SIZE 3 —

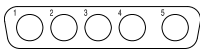

5W5

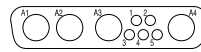

9W4

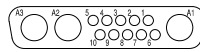

13W3

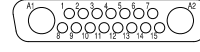

17W2

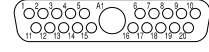

21W1

— SHELL SIZE 4 —

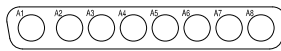

8W8

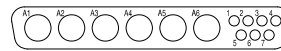

13W6

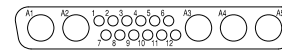

17W5

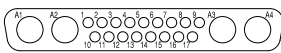

21WA4

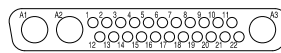

25W3

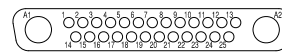

27W2

— SHELL SIZE 5 —

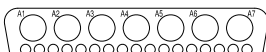

24W7

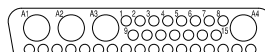

36W4



43W2



47W1

— SHELL SIZE 6 —

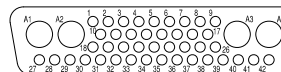

46W4

**Notes:**

\*1 2WK2 connectors have 1 male and 1 female contacts. Female connector should be loaded with female contact in A2 position.

\*2 3WK3 male variant contains 2 male contacts and 1 female contact. Female variant contains 2 female contacts and 1 male contact



Positronic Industries  
connectpositronic.com

# SCBM SERIES

## MILITARY / SPACE FLIGHT QUALITY

### STANDARD DENSITY PCB MOUNT

High  
Performance  
D-sub

### STANDARD CONNECTOR HOUSING (SHELLS) ASSEMBLY



SCBM3W3M0000G

SCBM5W5M0000G

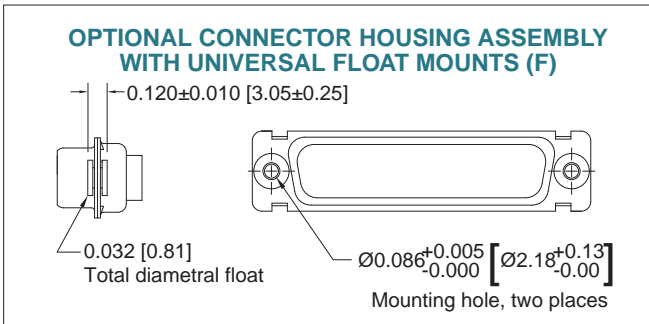
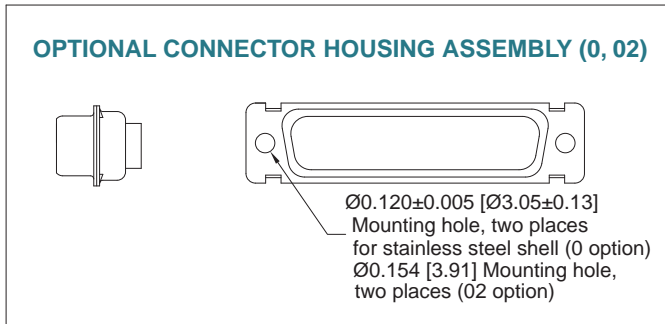
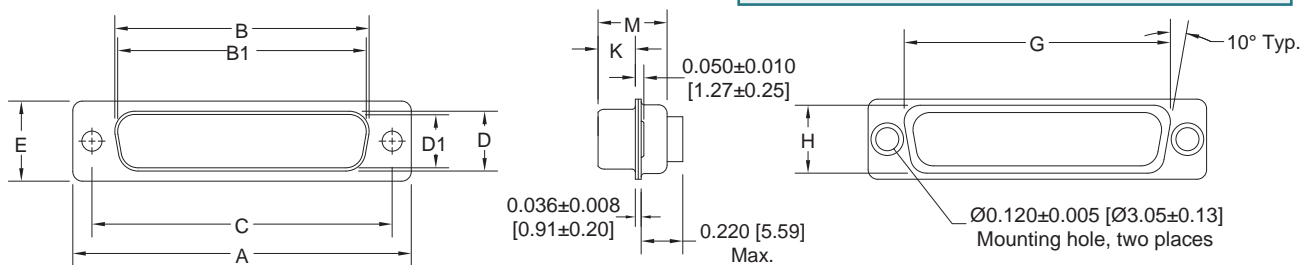
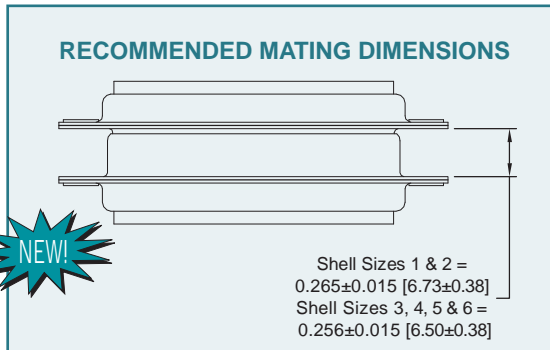

SCBM SERIES

SHELL SIZE	GENDER	A ±0.015 [0.38]	B ±0.005 [0.13]	B1 ±0.005 [0.13]	C ±0.005 [0.13]	D ±0.005 [0.13]	D1 ±0.005 [0.13]	E ±0.015 [0.38]	G ±0.010 [0.25]	H ±0.010 [0.25]	K ±0.005 [0.13]	M ±0.010 [0.25]
1	MALE	1.213 [30.81]		0.666 [16.92]	0.984 [24.99]		0.329 [8.36]	0.494 [12.55]	0.759 [19.28]	0.422 [10.72]	0.233 [5.92]	0.422 [10.72]
	FEMALE	1.213 [30.81]	0.643 [16.33]		0.984 [24.99]	0.311 [7.90]		0.494 [12.55]	0.759 [19.28]	0.422 [10.72]	0.243 [6.17]	0.429 [10.90]
2	MALE	1.541 [39.14]		0.994 [25.25]	1.312 [33.32]		0.329 [8.36]	0.494 [12.55]	1.083 [27.51]	0.422 [10.72]	0.233 [5.92]	0.422 [10.72]
	FEMALE	1.541 [39.14]	0.971 [24.66]		1.312 [33.32]	0.311 [7.90]		0.494 [12.55]	1.083 [27.51]	0.422 [10.72]	0.243 [6.17]	0.429 [10.90]
3	MALE	2.088 [53.04]		1.534 [38.96]	1.852 [47.04]		0.329 [8.36]	0.494 [12.55]	1.625 [41.28]	0.422 [10.72]	0.230 [5.84]	0.426 [10.82]
	FEMALE	2.088 [53.04]	1.511 [38.38]		1.852 [47.04]	0.311 [7.90]		0.494 [12.55]	1.625 [41.28]	0.422 [10.72]	0.243 [6.17]	0.429 [10.90]
4	MALE	2.729 [69.32]		2.182 [55.42]	2.500 [63.50]		0.329 [8.36]	0.494 [12.55]	2.272 [57.71]	0.422 [10.72]	0.230 [5.84]	0.426 [10.82]
	FEMALE	2.729 [69.32]	2.159 [54.84]		2.500 [63.50]	0.311 [7.90]		0.494 [12.55]	2.272 [57.71]	0.422 [10.72]	0.243 [6.17]	0.429 [10.90]
5	MALE	2.635 [66.93]		2.079 [52.81]	2.406 [61.11]		0.441 [11.20]	0.605 [15.37]	2.178 [55.32]	0.534 [13.56]	0.230 [5.84]	0.426 [10.82]
	FEMALE	2.635 [66.93]	2.064 [52.43]		2.406 [61.11]	0.423 [10.74]		0.605 [15.37]	2.178 [55.32]	0.534 [13.56]	0.243 [6.17]	0.429 [10.90]
6	MALE	2.729 [69.32]		2.212 [56.18]	2.500 [63.50]		0.503 [12.78]	0.668 [16.97]	2.302 [58.47]	0.596 [15.14]	0.230 [5.84]	0.426 [10.82]
	FEMALE	2.729 [69.32]	2.189 [55.60]		2.500 [63.50]	0.485 [12.32]		0.668 [16.97]	2.302 [58.47]	0.596 [15.14]	0.243 [6.17]	0.429 [10.90]



**SOLDER CUP TERMINATION  
CODE 2**

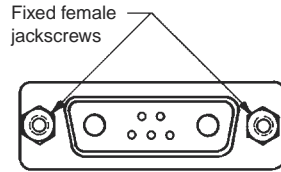
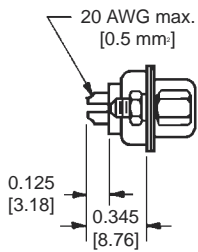

For solder cup contacts,  
specify code 2 in step 4 of  
ordering information.

Typical Part Number:  
**SCBM7W2M200T2G**

Fixed female jackscrew      Fixed male jackscrew

Fixed male and female polarized jackscrews available.  
Specify code T6 in step 7 of ordering information.

**TYPICAL PART NUMBER: SCBM7W2S200T6G**



SCBM21WA4M2000G WITH MS4820M

SCBM21WA4S65S00G

**STRAIGHT SOLDER PRINTED BOARD MOUNT TERMINATION  
CODE 3, 35, 36 AND 37**

*1 CODE NUMBER	D Ø
3	Size 8 contacts not supplied
35	0.078 [1.98]
 36	0.094 [2.39]
37	0.125 [3.18]

**NOTE:**

\*1 Contact termination code as specified in Step 4 of ordering information.

Swaged spacer with push-on fastener, phosphor bronze.

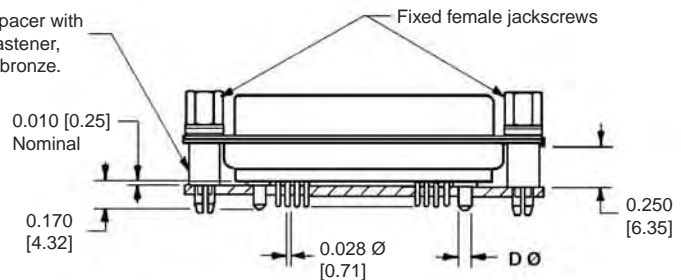

**TYPICAL PART NUMBER:  
SCBM17W2S35S60T2G**



Positronic Industries  
connectpositronic.com

# SCBM SERIES

## MILITARY / SPACE FLIGHT QUALITY

### STANDARD DENSITY PCB MOUNT

High  
Performance  
D-sub

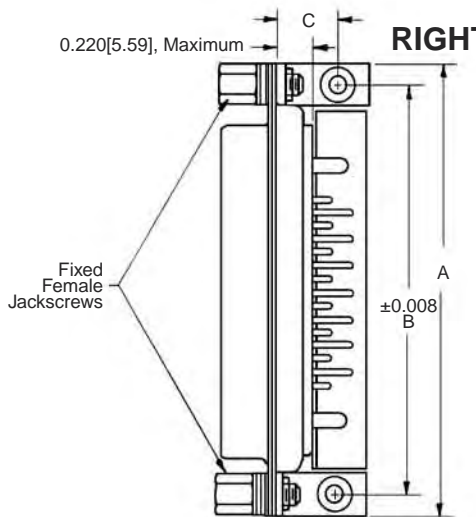

### RIGHT ANGLE (90°) PRINTED BOARD MOUNT TERMINATION WITH 0.078 [1.98] Ø POWER CONTACTS CODE 5 AND 55, 0.283 [7.19] CONTACT EXTENSION

See temperature rise curves on pages 3 and 4

SCBM**(5 or 55)**** 0.283 [7.19] CONTACT EXTENSION				
SHELL SIZE	A	B	C	D
SHELL SIZE 1	1.204 [30.58]	0.984 [24.99]	0.339 [8.61]	0.283 [7.19]
SHELL SIZE 2	1.532 [38.91]	1.312 [33.32]	0.339 [8.61]	0.283 [7.19]
SHELL SIZE 3	2.072 [52.63]	1.852 [47.04]	0.339 [8.61]	0.283 [7.19]
SHELL SIZE 4	2.720 [69.09]	2.500 [63.50]	0.339 [8.61]	0.283 [7.19]
SHELL SIZE 5	2.626 [66.70]	2.406 [61.11]	0.395 [10.03]	0.283 [7.19]

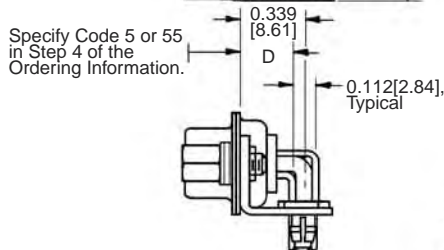

TYPICAL PART NUMBER:  
SCBM17W2M55R7NT2G

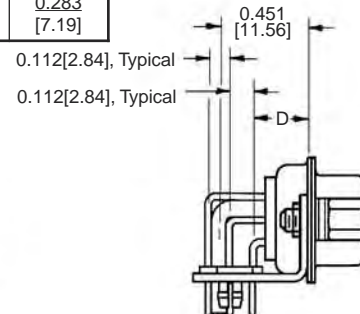
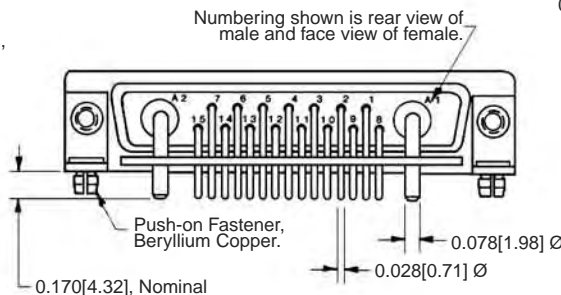

SCBM SERIES

### SHELL SIZE 6 RIGHT ANGLE (90°) PRINTED BOARD MOUNT TERMINATION WITH 0.078 [1.98] Ø POWER CONTACTS CODE 5 AND 55, 0.283 [7.19] CONTACT EXTENSION

CONNECTOR VARIANT 46W4

See temperature rise curves on pages 3 and 4

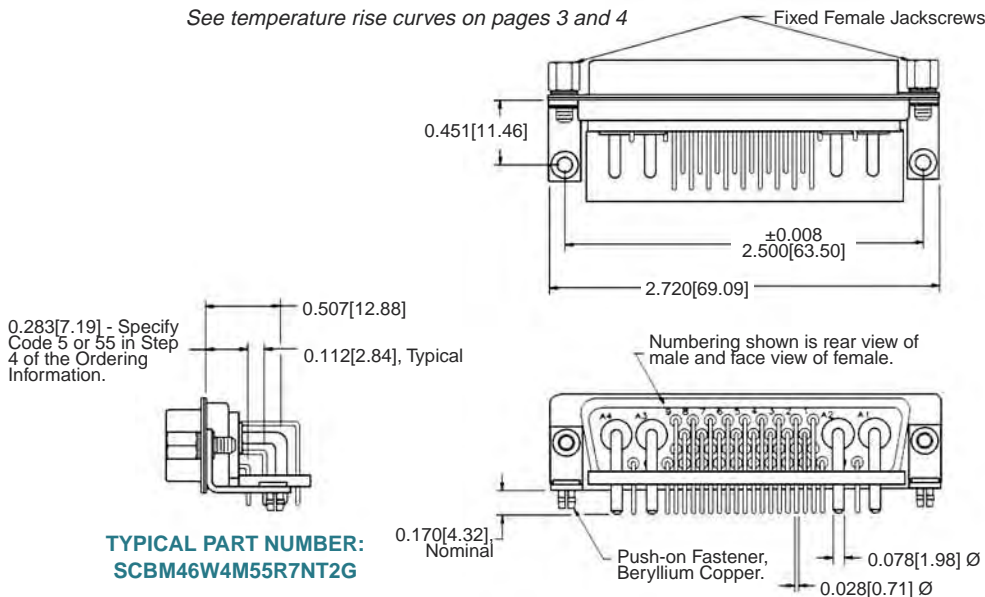





**RIGHT ANGLE (90°) PRINTED BOARD MOUNT TERMINATION  
WITH 0.125 [3.18] Ø POWER CONTACTS**

**CODE 5 AND 57, 0.283 [7.19] CONTACT EXTENSION**

See temperature rise curves on pages 3 and 4

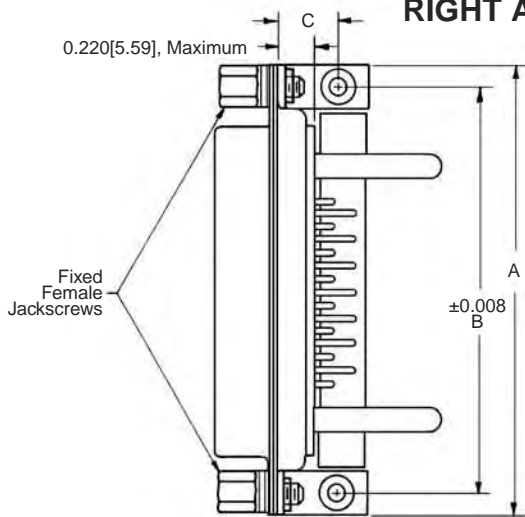

SCBM**(5 or 57)**** 0.283 [7.19] CONTACT EXTENSION				
SHELL SIZE	A	B	C	D
SHELL SIZE 1	1.204 [30.58]	0.984 [24.99]	0.339 [8.61]	0.283 [7.19]
SHELL SIZE 2	1.532 [38.91]	1.312 [33.32]	0.339 [8.61]	0.283 [7.19]
SHELL SIZE 3	2.072 [52.63]	1.852 [47.04]	0.339 [8.61]	0.283 [7.19]
SHELL SIZE 4	2.720 [69.09]	2.500 [63.50]	0.339 [8.61]	0.283 [7.19]
SHELL SIZE 5	2.626 [66.70]	2.406 [61.11]	0.395 [10.03]	0.283 [7.19]

Specify Code 5 or 57  
in Step 4 of the  
Ordering Information.

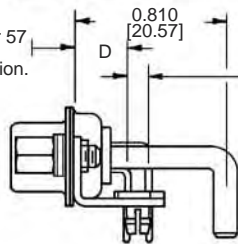

**TYPICAL PART NUMBER:  
SCBM17W2M57R7NT2G**

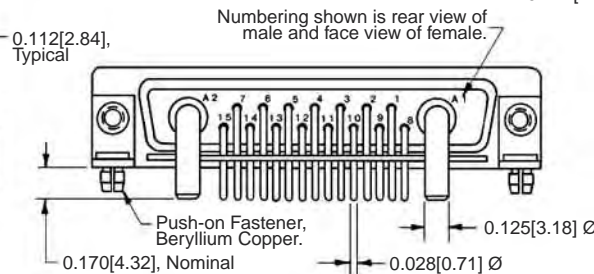

0.112[2.84], Typical  
0.112[2.84], Typical

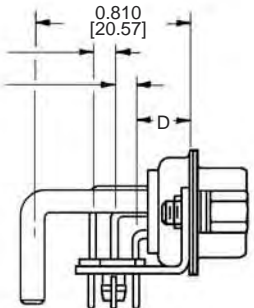

**Typical Part Number:  
SCBM36W4S57R7NT2G**

**SHELL SIZE 6**

**RIGHT ANGLE (90°) PRINTED BOARD MOUNT TERMINATION  
WITH 0.125 [3.18] Ø POWER CONTACTS**

**CODE 5 AND 57, 0.283 [7.19] CONTACT EXTENSION**

**CONNECTOR VARIANT 46W4**

See temperature rise curves on pages 3 and 4

**SHELL SIZE 6 CONNECTOR**

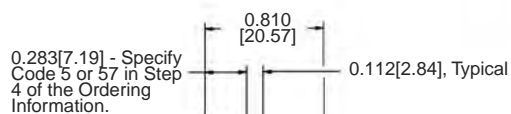
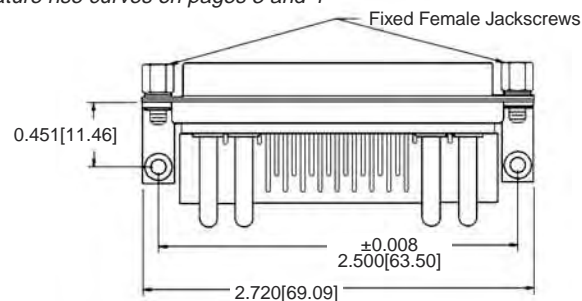

**TYPICAL PART NUMBER:  
SCBM46W4M57R7NT2G**

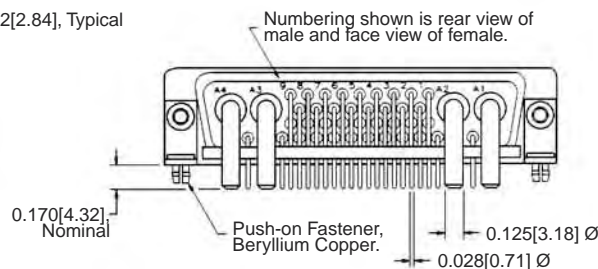



Positronic Industries  
connectpositronic.com

# SCBM SERIES

## MILITARY / SPACE FLIGHT QUALITY

### STANDARD DENSITY PCB MOUNT

High  
Performance  
D-sub

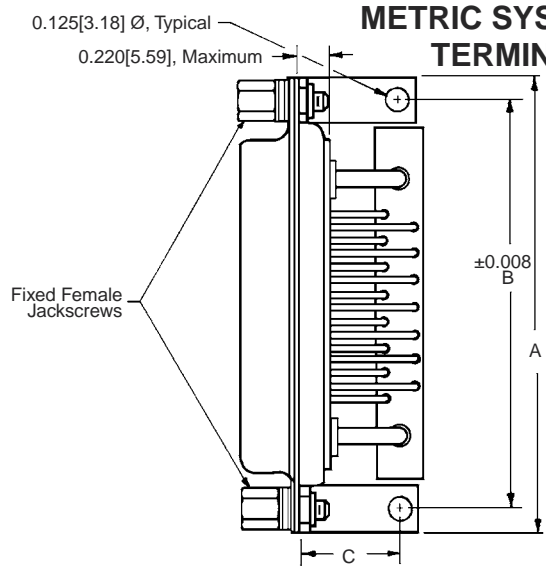

### METRIC SYSTEM RIGHT ANGLE (90°) PRINTED BOARD MOUNT TERMINATION WITH 0.078 [1.98] Ø POWER CONTACTS

CODE 7 AND 75, 0.370 [9.40] CONTACT EXTENSION

See temperature rise curves on pages 3 and 4

SCBM**(7 or 75)*** 0.370 [9.40] CONTACT EXTENSION				
SHELL SIZE	A	B	C	D
SHELL SIZE 1	1.204 [30.58]	0.984 [24.99]	0.420 [10.67]	0.370 [9.40]
SHELL SIZE 2	1.532 [38.91]	1.312 [33.32]	0.420 [10.67]	0.370 [9.40]
SHELL SIZE 3	2.072 [52.63]	1.852 [47.04]	0.420 [10.67]	0.370 [9.40]
SHELL SIZE 4	2.720 [69.09]	2.500 [63.50]	0.420 [10.67]	0.370 [9.40]
SHELL SIZE 5	2.626 [66.70]	2.406 [61.11]	0.470 [11.94]	0.370 [9.40]

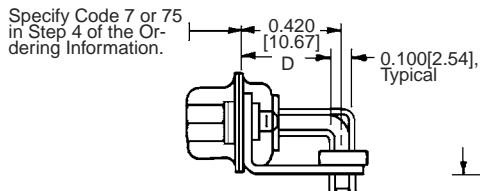

TYPICAL PART NUMBER:  
SCBM17W2M75R70T2G

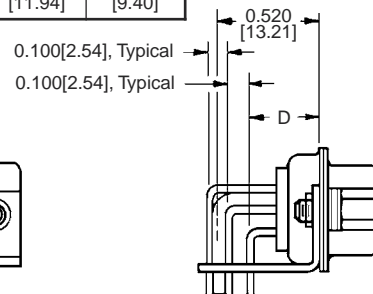
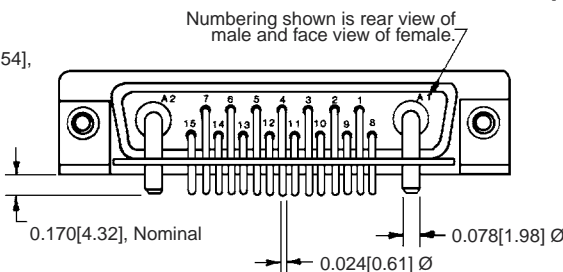

TYPICAL PART NUMBER:  
SCBM36W4S75R70T2G

SCBM SERIES

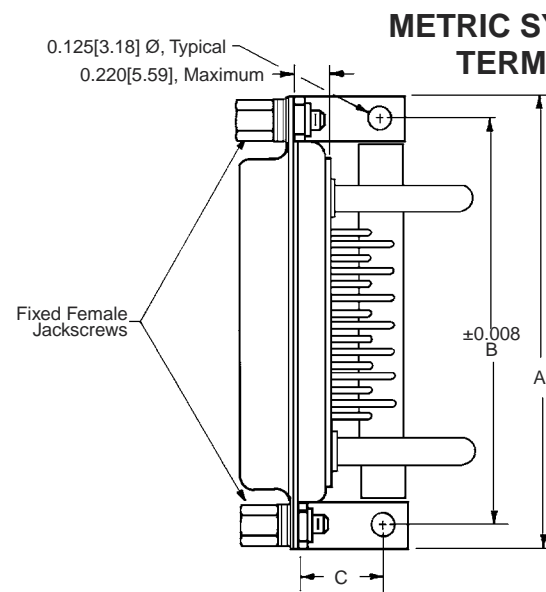

### METRIC SYSTEM RIGHT ANGLE (90°) PRINTED BOARD MOUNT TERMINATION WITH 0.125 [3.18] Ø POWER CONTACTS

CODE 7 AND 77, 0.370 [9.40] CONTACT EXTENSION

SCBM*** (7 or 77)*** 0.370 [9.40] CONTACT EXTENSION				
SHELL SIZE	A	B	C	D
SHELL SIZE 1	1.204 [30.58]	0.984 [24.99]	0.420 [10.67]	0.370 [9.40]
SHELL SIZE 2	1.532 [38.91]	1.312 [33.32]	0.420 [10.67]	0.370 [9.40]
SHELL SIZE 3	2.072 [52.63]	1.852 [47.04]	0.420 [10.67]	0.370 [9.40]
SHELL SIZE 4	2.720 [69.09]	2.500 [63.50]	0.420 [10.67]	0.370 [9.40]
SHELL SIZE 5	2.626 [66.70]	2.406 [61.11]	0.470 [11.94]	0.370 [9.40]

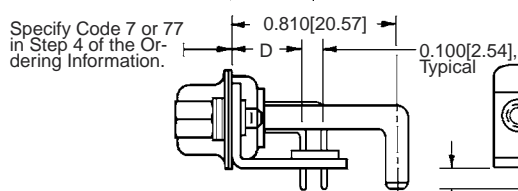

TYPICAL PART NUMBER:  
SCBM17W2M77R70T2G

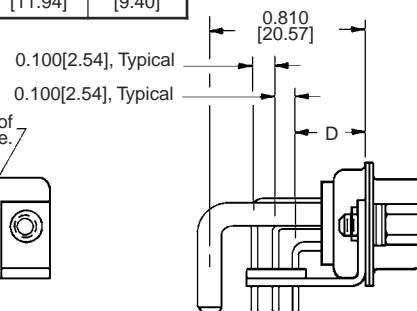
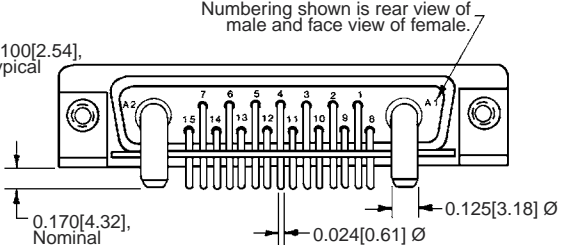

TYPICAL PART NUMBER:  
SCBM36W4S77R70T2G



**PRINTED BOARD CONTACT HOLE PATTERNS**

**RIGHT ANGLE (90°) WITH 0.078 [1.98] Ø POWER CONTACTS AND STRAIGHT SOLDER PRINTED BOARD MOUNT WITH 0.078 [1.98] Ø, 0.094 [2.39] Ø AND 0.125 [3.18] Ø POWER CONTACTS**

HOLE IDENTIFICATION SHOWN FOR MALE CONNECTOR; USE MIRROR IMAGE FOR FEMALE CONNECTOR.  
MOUNT CONNECTOR WITH MATING FACE POSITIONED TO FOLLOW DIRECTION OF ARROWS.

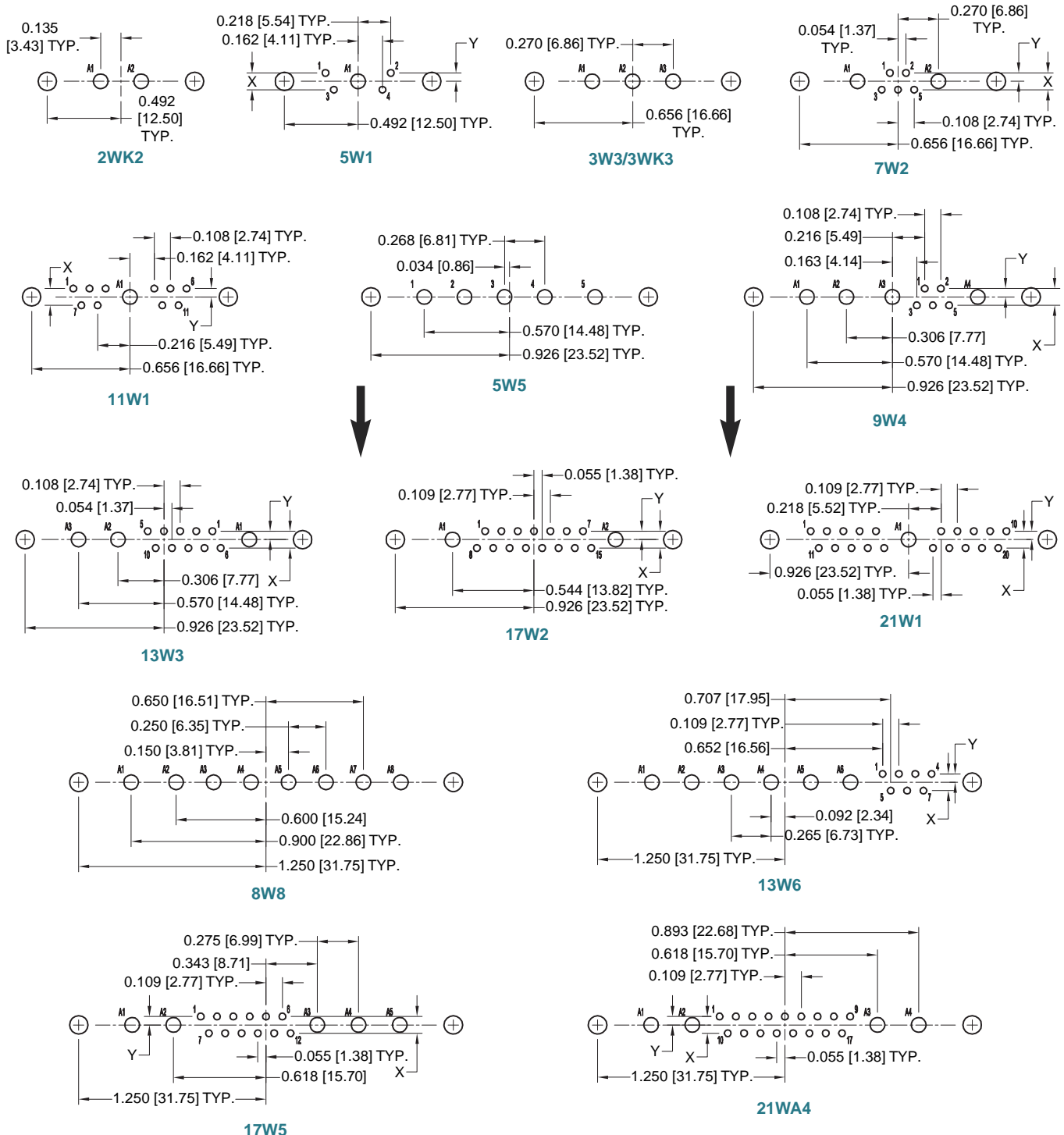

**SUGGESTED PRINTED BOARD HOLE SIZES:**

- Suggest 0.045 [1.14] Ø hole for size 20 contact termination positions.
- Suggest 0.098 [2.49] Ø hole for 0.078 [1.98] Ø power contact termination positions.
- Suggest 0.114 [2.90] Ø hole for 0.094 [2.39] Ø power contact termination positions.
- Suggest 0.145 [3.68] Ø hole for 0.125 [3.18] Ø power contact termination positions.
- Suggest 0.123 ±0.003 [3.12] Ø hole for mounting connector with push-on fasteners.

For "X" and "Y" dimensions, see chart on page 29.

*continued on next page. . .*



### PRINTED BOARD CONTACT HOLE PATTERNS

#### RIGHT ANGLE (90°) WITH 0.078 [1.98] Ø POWER CONTACTS AND STRAIGHT SOLDER PRINTED BOARD MOUNT WITH 0.078 [1.98] Ø, 0.094 [2.39] Ø AND 0.125 [3.18] Ø POWER CONTACTS

HOLE IDENTIFICATION SHOWN FOR MALE CONNECTOR; USE MIRROR IMAGE FOR FEMALE CONNECTOR.  
MOUNT CONNECTOR WITH MATING FACE POSITIONED TO FOLLOW DIRECTION OF ARROWS.

continued from previous page. . .

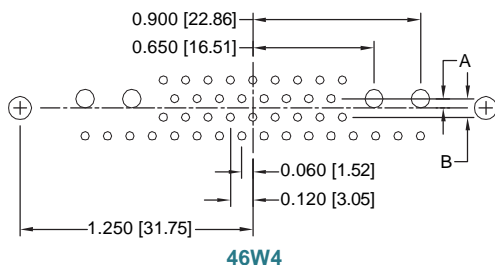
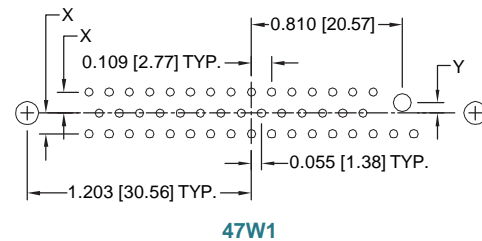
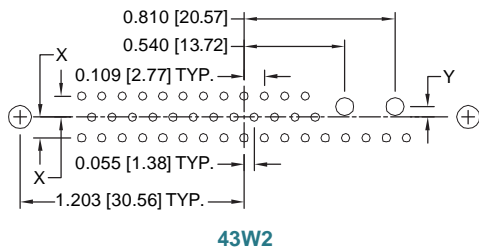
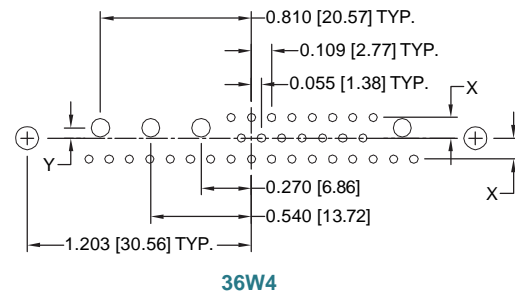
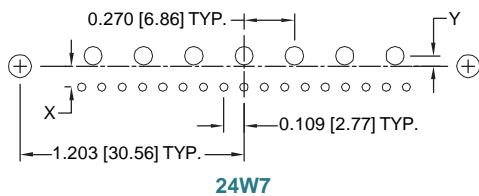
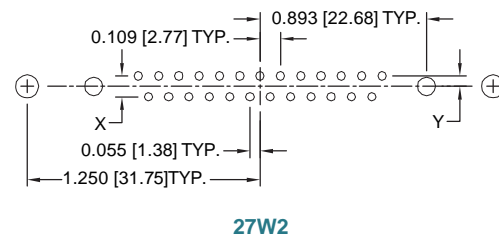
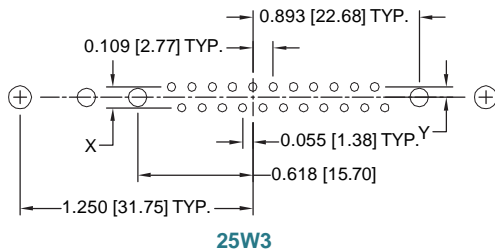

CODE NUMBER	X	Y	A	B
3				
35				
36	0.112 [2.84]	0.056 [1.42]	0.050 [1.27]	0.100 [2.54]
37				
5	0.112 [2.84]	0.056 [1.42]	0.056 [1.42]	0.112 [2.84]
55				
7	0.100 [2.54]	0.050 [1.27]	0.050 [1.27]	0.100 [2.54]
75				

#### SUGGESTED PRINTED BOARD HOLE SIZES:

- Suggest 0.045 [1.14] Ø hole for size 20 contact termination positions.
- Suggest 0.098 [2.49] Ø hole for 0.078 [1.98] Ø power contact termination positions.
- Suggest 0.114 [2.90] Ø hole for 0.094 [2.39] Ø power contact termination positions.
- Suggest 0.145 [3.68] Ø hole for 0.125 [3.18] Ø power contact termination positions.
- Suggest 0.123 ±0.003 [3.12] Ø hole for mounting connector with push-on fasteners.



**PRINTED BOARD CONTACT HOLE PATTERN**  
**RIGHT ANGLE (90°) WITH 0.125 [3.18] Ø POWER CONTACTS**

HOLE IDENTIFICATION SHOWN FOR MALE CONNECTOR; USE MIRROR IMAGE FOR FEMALE CONNECTOR.  
MOUNT CONNECTOR WITH MATING FACE POSITIONED TO FOLLOW DIRECTION OF ARROWS.

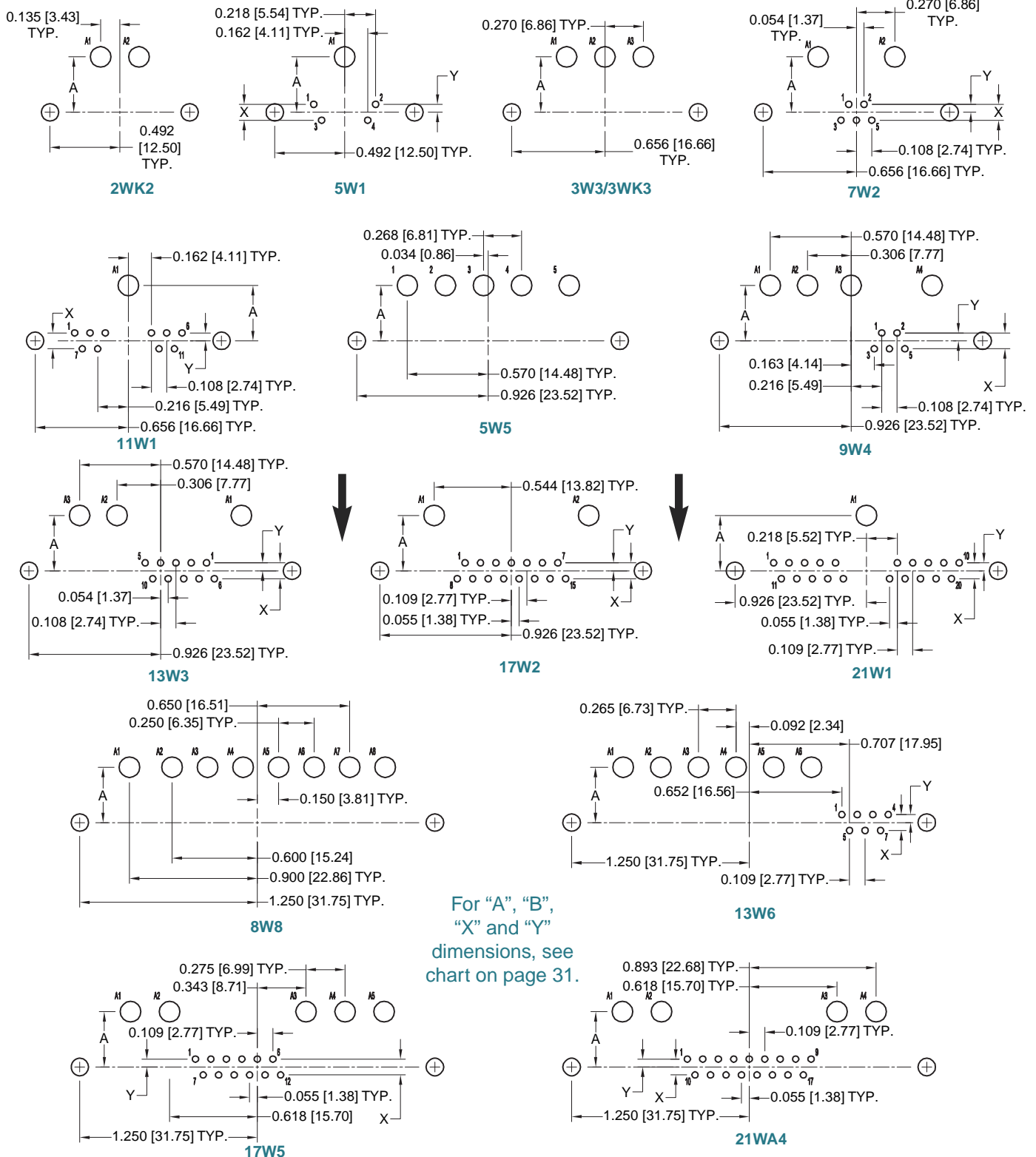

**SUGGESTED PRINTED BOARD HOLE SIZES:**

Suggest 0.045 [1.14] Ø hole for size 20 contact termination positions.  
Suggest 0.145 [3.68] Ø hole for power contact termination positions.  
Suggest 0.123±0.003 [3.12] Ø hole for mounting connector with push-on fasteners.

*continued on next page. . . .*



### PRINTED BOARD CONTACT HOLE PATTERN

#### RIGHT ANGLE (90°) WITH 0.125 [3.18] Ø POWER CONTACTS

HOLE IDENTIFICATION SHOWN FOR MALE CONNECTOR; USE MIRROR IMAGE FOR FEMALE CONNECTOR.  
MOUNT CONNECTOR WITH MATING FACE POSITIONED TO FOLLOW DIRECTION OF ARROWS.

continued from previous page...

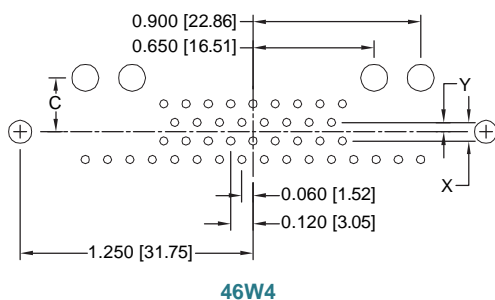
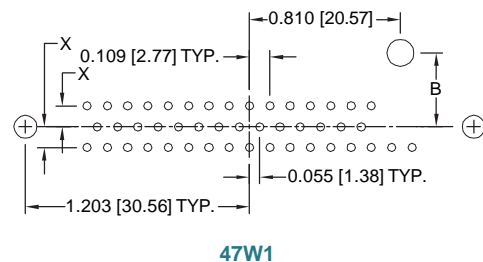
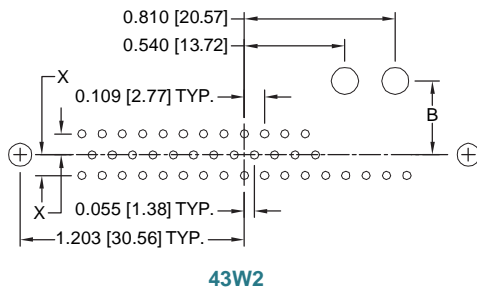
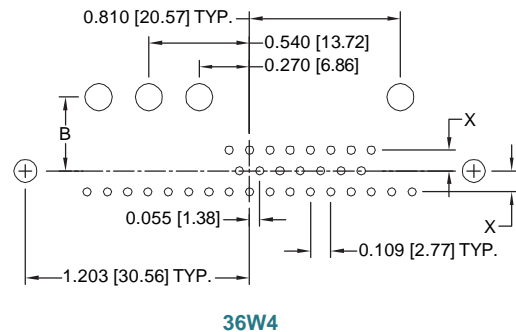
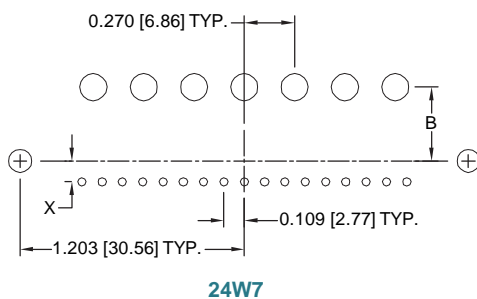
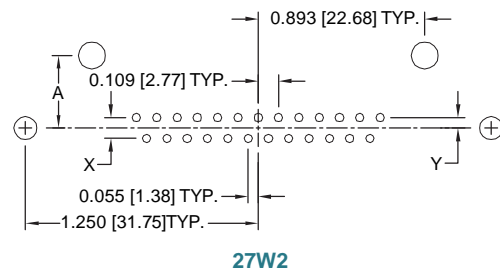
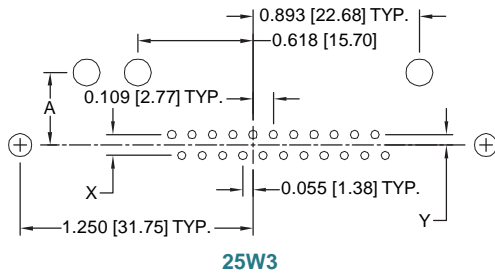

CODE NUMBER	A	B	C	X	Y
5	0.471 [11.96]	0.415 [10.54]	0.359 [9.12]	0.112 [2.84]	0.056 [1.42]
57	0.471 [11.96]	0.415 [10.54]	0.359 [9.12]	0.112 [2.84]	0.056 [1.42]
7	0.390 [9.91]	0.340 [8.64]	0.290 [7.37]	0.100 [2.54]	0.056 [1.42]
77	0.390 [9.91]	0.340 [8.64]	0.290 [7.37]	0.100 [2.54]	0.056 [1.42]

#### SUGGESTED PRINTED BOARD HOLE SIZES:

Suggest 0.045 [1.14] Ø hole for size 20 contact termination positions.  
Suggest 0.145 [3.68] Ø hole for power contact termination positions.  
Suggest 0.123±0.003 [3.12] Ø hole for mounting connector with push-on fasteners.



**STRAIGHT SOLDER PRINTED BOARD MOUNT TERMINATION WITH SHIELDED CONTACTS**  
**CODE 65, CONNECTOR WITH FDS4201M OR MDS4201M CONTACTS**

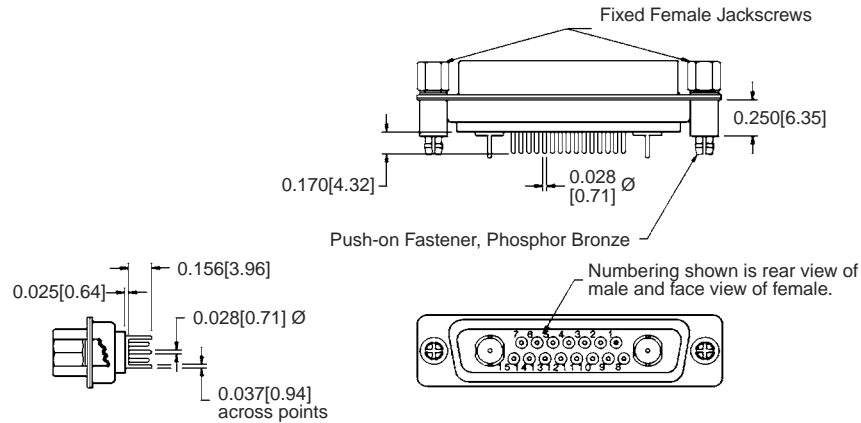

**TYPICAL PART NUMBER:**  
**SCBM17W2M65S60T2G**

**RIGHT ANGLE (90°) PRINTED BOARD MOUNT TERMINATION WITH SHIELDED CONTACTS**  
**CODE 85, CONNECTOR WITH FRT4201M OR MRT4201M CONTACTS**

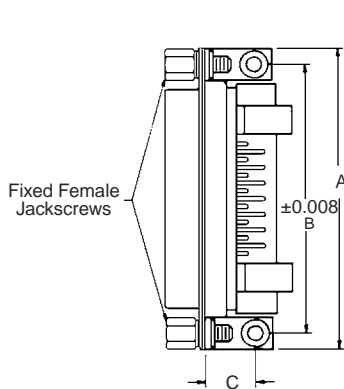

SCBM**85**** 0.283 [7.19] CONTACT EXTENSION				
SHELL SIZE	A	B	C	D
SHELL SIZE 1	1.204 [30.58]	0.984 [24.99]	0.339 [8.61]	0.283 [7.19]
SHELL SIZE 2	1.532 [38.91]	1.312 [33.32]	0.339 [8.61]	0.283 [7.19]
SHELL SIZE 3	2.072 [52.63]	1.852 [47.04]	0.339 [8.61]	0.283 [7.19]
SHELL SIZE 4	2.720 [69.09]	2.500 [63.50]	0.339 [8.61]	0.283 [7.19]
*1 SHELL SIZE 5	2.626 [66.70]	2.406 [61.11]	0.395 [10.03]	0.545 [13.84]

**NOTE:**

\*1 Shell size 5 connectors are supplied inverted when ordered with right angle (90°) printed board mount shielded contacts.

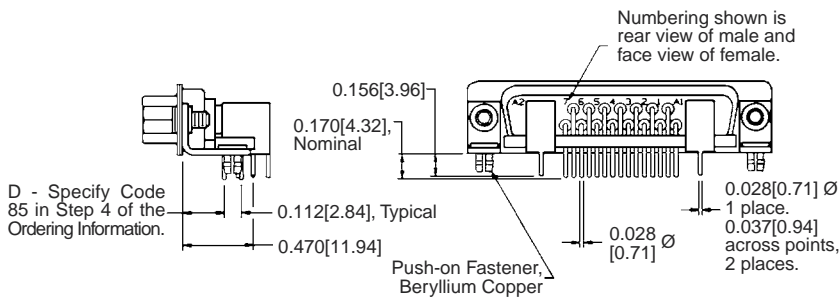

**TYPICAL PART NUMBER:**  
**SCBM17W2M85R7NT2G**

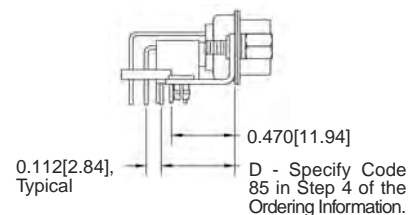

**TYPICAL PART NUMBER:**  
**SCBM36W4M85R7NT2G**



### STRAIGHT SOLDER PRINTED BOARD MOUNT CONTACT HOLE PATTERN WITH FDS4201M AND MDS4201M SHIELDED CONTACTS

HOLE IDENTIFICATION SHOWN FOR MALE CONNECTOR; USE MIRROR IMAGE FOR FEMALE CONNECTOR.

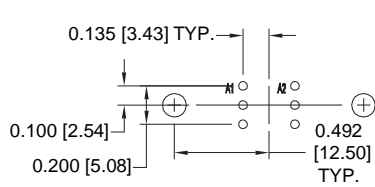

2WK2

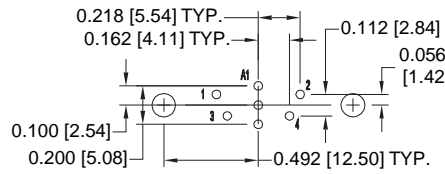

5W1

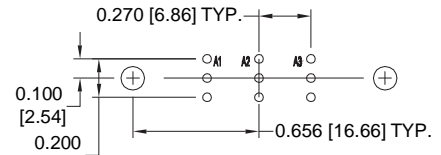

3W3/3WK3

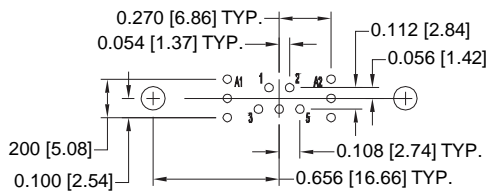

7W2

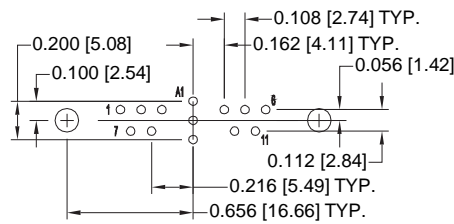

11W1

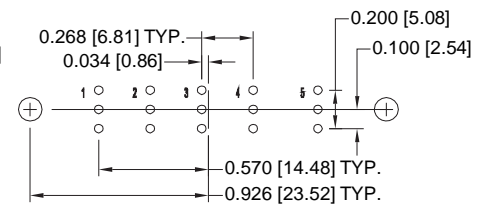

5W5

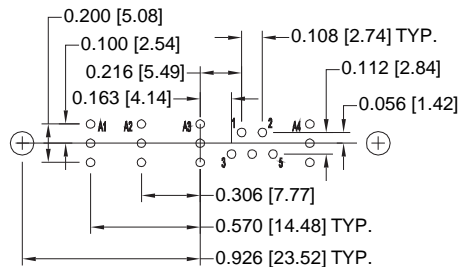

9W4

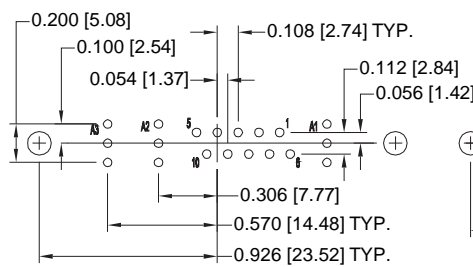

13W3

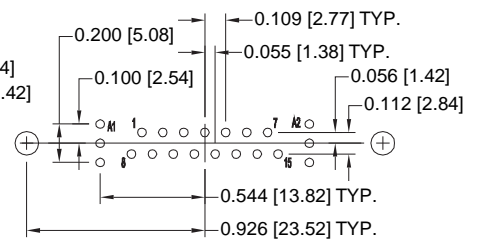

17W2

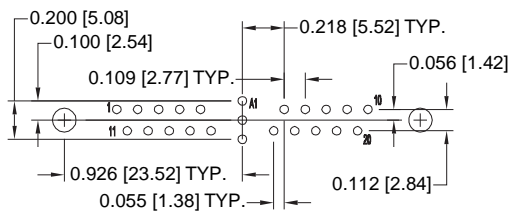

21W1

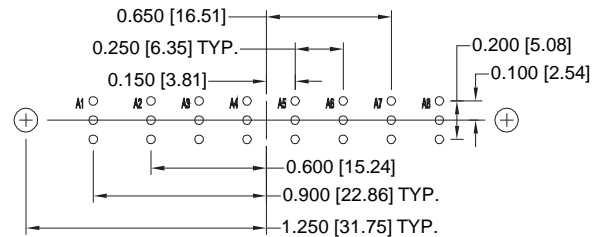

8W8

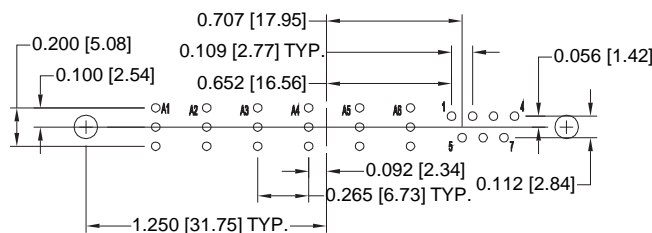

13W6

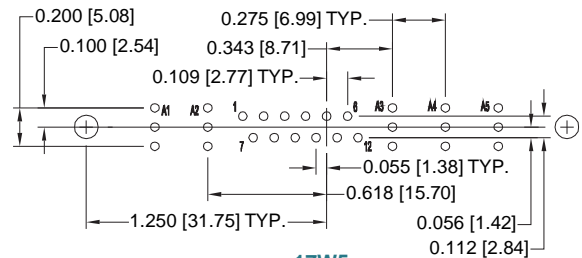

17W5

continued on next page . . .

### SUGGESTED PRINTED BOARD HOLE SIZES:

Suggest 0.045 [1.14] Ø hole for size 20 contact termination position.  
Suggest 0.123±0.003 [3.12] Ø hole for mounting connector with push-on fasteners.





**STRAIGHT SOLDER PRINTED BOARD MOUNT CONTACT HOLE PATTERN  
WITH FDS4201M AND MDS4201M SHIELDED CONTACTS**

HOLE IDENTIFICATION SHOWN FOR MALE CONNECTOR; USE MIRROR IMAGE FOR FEMALE CONNECTOR.

continued from previous page . . .

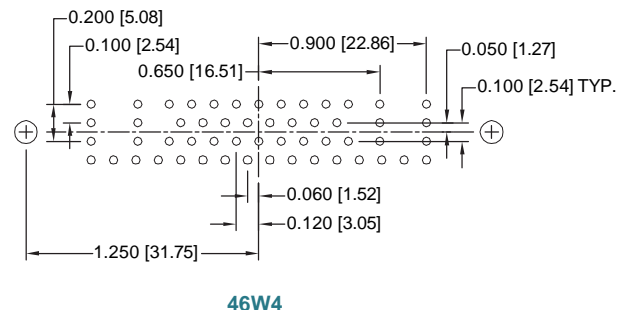
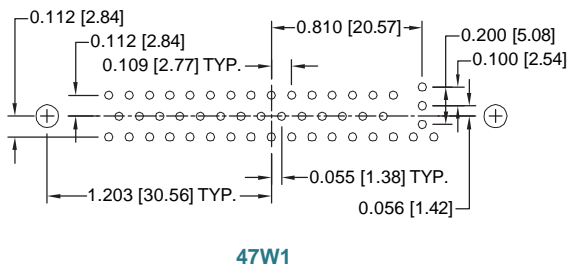
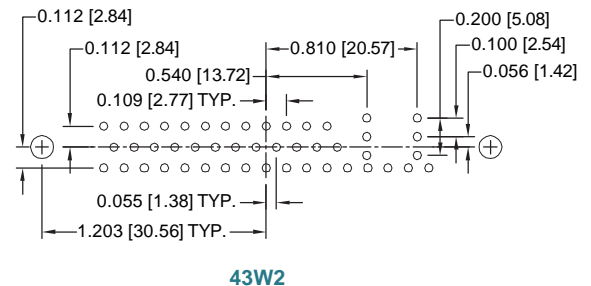
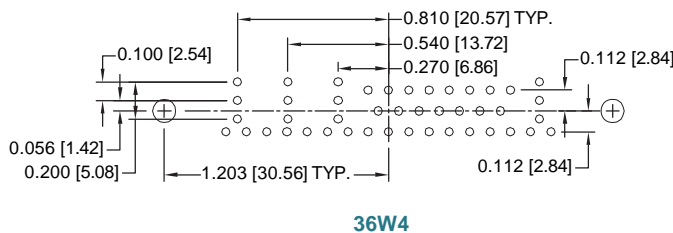
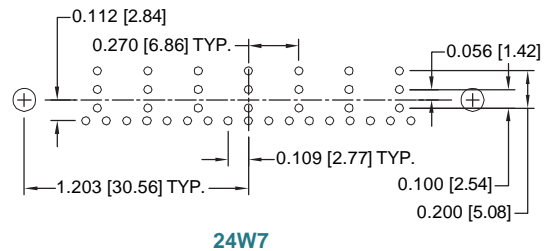
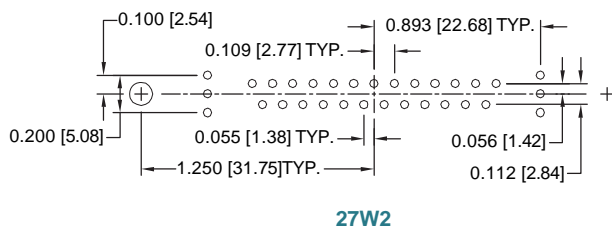
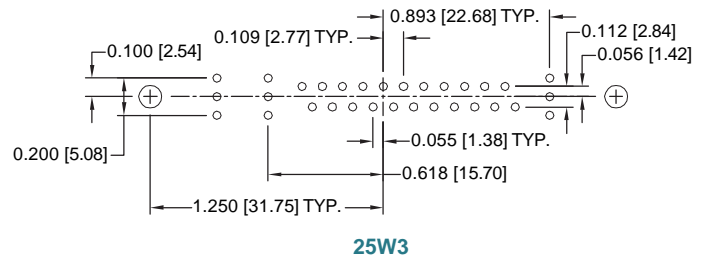
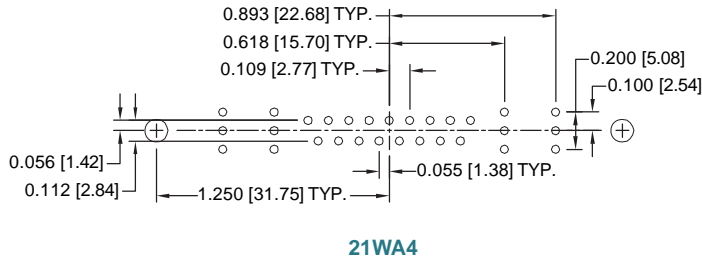

**SUGGESTED PRINTED BOARD HOLE SIZES:**

Suggest 0.045 [1.14] Ø hole for size 20 contact termination position.  
Suggest 0.123±0.003 [3.12] Ø hole for mounting connector with push-on fasteners.



Positronic Industries  
connectpositronic.com

# SCBM SERIES

## MILITARY / SPACE FLIGHT QUALITY

### STANDARD DENSITY PCB MOUNT

High  
Performance  
D-sub

### RIGHT ANGLE (90°) PRINTED BOARD MOUNT CONTACT HOLE PATTERN WITH FRT4201M AND MRT4201M SHIELDED CONTACTS

HOLE IDENTIFICATION SHOWN IS FOR MALE CONNECTOR; USE MIRROR IMAGE FOR FEMALE CONNECTOR.

MOUNT CONNECTOR WITH MATING FACE POSITIONED TO FOLLOW DIRECTION OF ARROW.

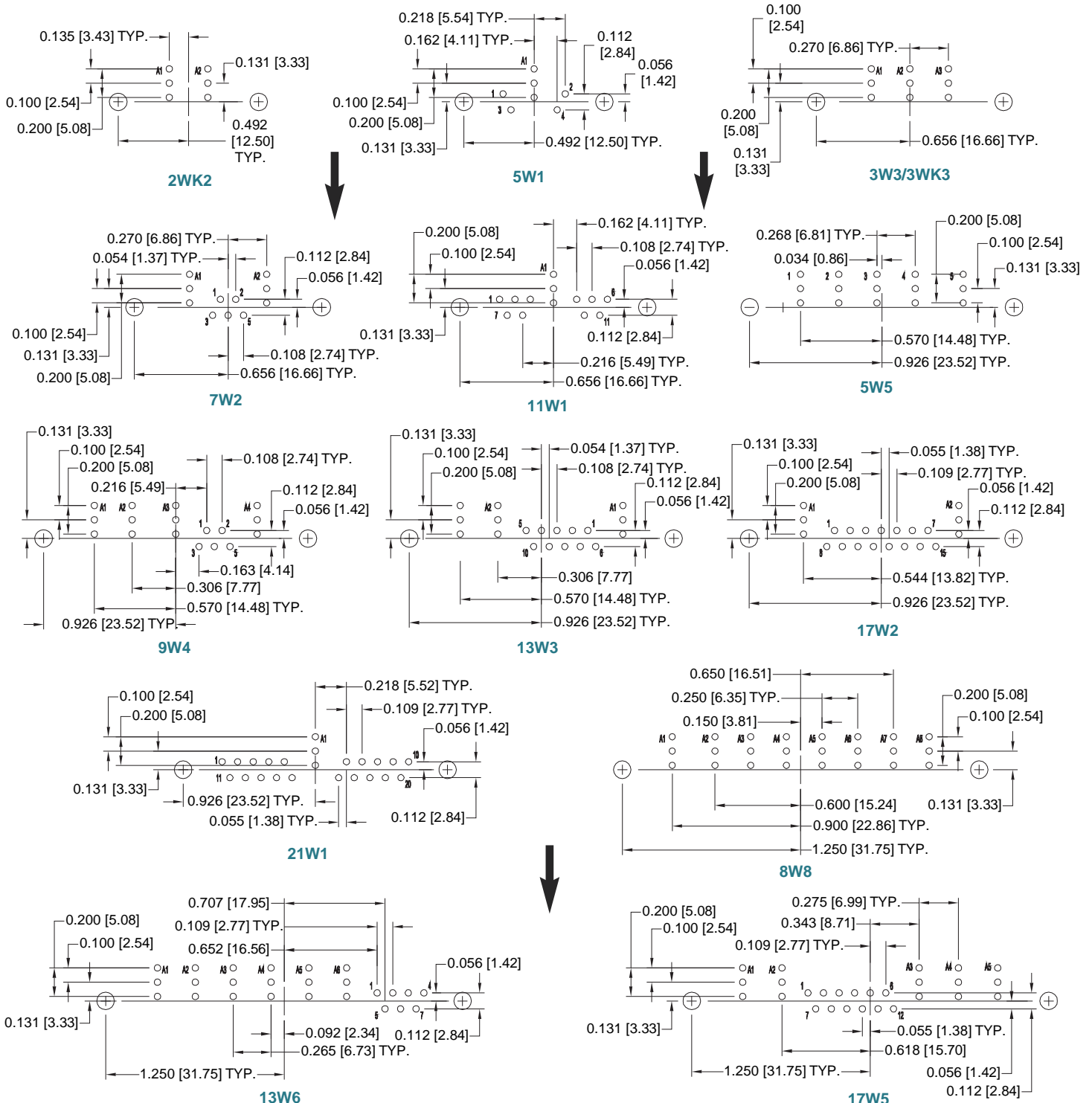

continued on next page . . .

### SUGGESTED PRINTED BOARD HOLE SIZES:

Suggest 0.045 [1.14] Ø hole for size 20 contact termination position.  
Suggest 0.123±0.003 [3.12] Ø hole for mounting connector with push-on fasteners.



**RIGHT ANGLE (90°) PRINTED BOARD MOUNT CONTACT HOLE PATTERN  
WITH FRT4201M AND MRT4201M SHIELDED CONTACTS**

HOLE IDENTIFICATION SHOWN IS FOR MALE CONNECTOR; USE MIRROR IMAGE FOR FEMALE CONNECTOR.  
MOUNT CONNECTOR WITH MATING FACE POSITIONED TO FOLLOW DIRECTION OF ARROW.

continued from previous page. . .

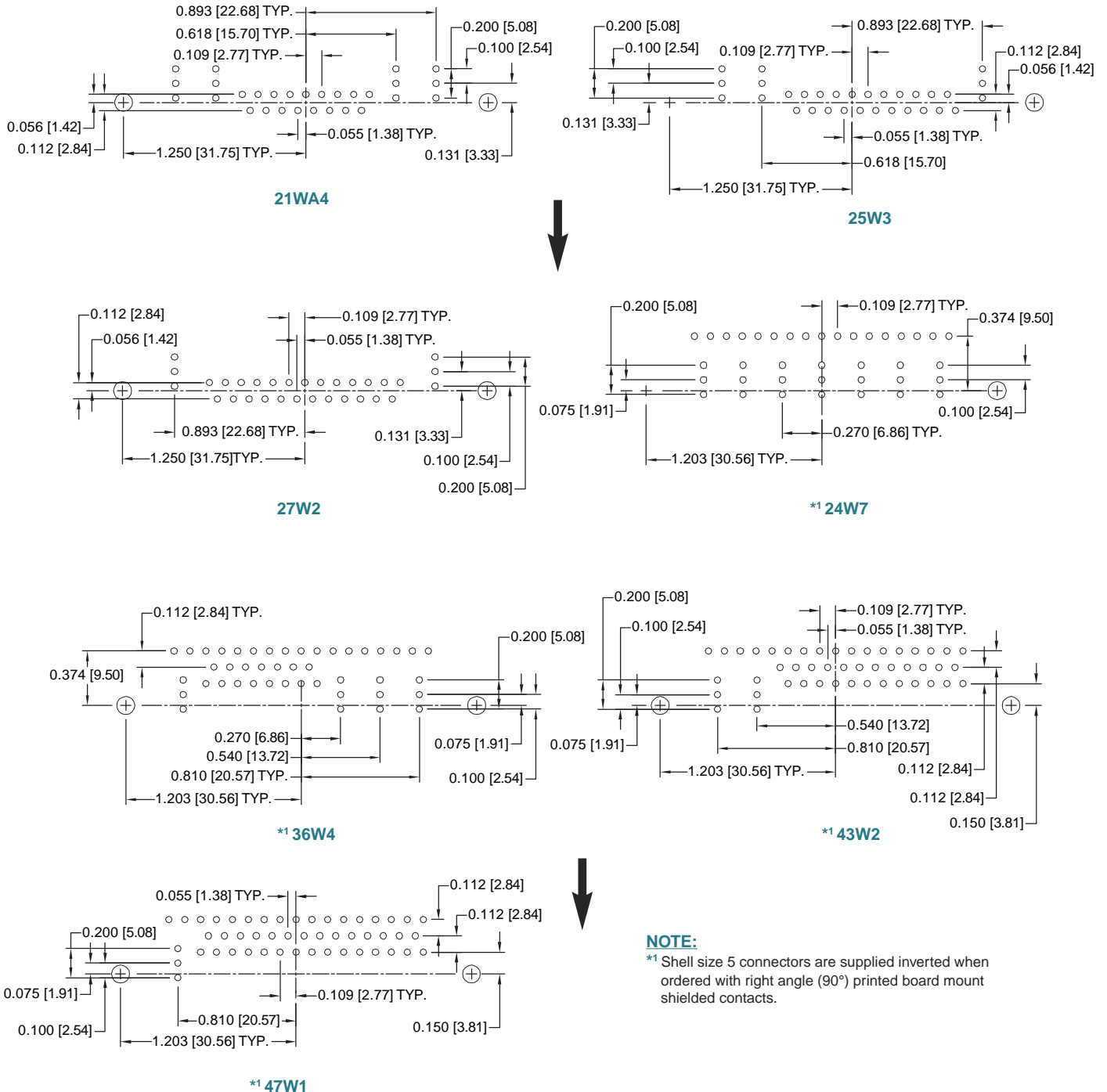

**NOTE:**  
\*1 Shell size 5 connectors are supplied inverted when ordered with right angle (90°) printed board mount shielded contacts.

**SUGGESTED PRINTED BOARD HOLE SIZES:**

Suggest 0.045 [1.14] Ø hole for size 20 contact termination position.  
Suggest 0.123±0.003 [3.12] Ø hole for mounting connector with push-on fasteners.



## REMOVABLE CONTACT ORDERING ASSISTANCE CHART



### SCBM SERIES CRIMP AND SOLDER CUP TERMINATION CONTACTS

TYPE	PAGE NUMBER REFERENCE IN CATALOG	CONTACT SIZE	FEMALE PART NUMBER	MALE PART NUMBER	WIRE SIZE AWG [mm <sup>2</sup> ]
CRIMP	see page 81 for additional information	8	FC4008M	MC4008M	8 [10.0]
			FC4010M	MC4010M	10 [5.3]
			FC4012M	MC4012M	12 [4.0]
			FC4016M	MC4016M	16 [1.5]
SOLDER CUP	see page 82 for additional information	8	FS4008M	MS4008M	8 [10.0]
			FS4012M	MS4012M	12 [4.0]
			FS4016M	MS4016M	16 [1.5]
HIGH VOLTAGE <i>Straight Solder Wire</i>	see page 83 for additional information	8	FS4820M	MS4820M	20 [0.5]
HIGH VOLTAGE <i>Right Angle (90°) Solder Wire</i>			FS4920M	MS4920M	20 [0.5]
SHIELDED	see page 84 for additional information	SOLDER / CRIMP	FC4101M	MC4101M	RG 178 B/U, 196 B/U
			FC4102M	MC4102M	RG 179 BU/, 316 B/U
			FC4103M	MC4103M	RG 180 B/U
			FC4104M	MC4104M	RG 58 B/U
		SOLDER / SOLDER	FS4101M	MS4101M	RG 178 B/U, 196 B/U
			FS4102M	MS4102M	RG 179 B/U, 316 B/U
			FS4103M	MS4103M	RG 180 B/U
			FS4104M	MS4104M	RG 58 B/U
		CRIMP / CRIMP	FCC4101M	MCC4101M	RG 178 B/U, 196 B/U
			FCC4102M	MCC4102M	RG 179 BU/, 316 B/U
			FCC4103M	MCC4103M	RG 180 B/U
			FCC4104M	MCC4104M	RG 58 B/U

**NOTE:** For ordering crimp contacts on reels, add "R" to part number, see page 77 for details. Examples: FC4008MR or MC4008MR

### SCBM SERIES PRINTED BOARD MOUNT TERMINATION CONTACTS

TERMINATION TYPE	PAGE NUMBER REFERENCE IN CATALOG	CONTACT SIZE	FEMALE PART NUMBER	MALE PART NUMBER	TERMINATION LENGTH	TERMINATION DIMENSION
STRAIGHT SOLDER PRINTED BOARD MOUNT	see page 82 for additional information	8	FDS4314M	MDS4314M	0.170 [4.32]	0.078 [1.98] Ø
			FDS4312M	MDS4312M		0.094 [2.39] Ø
			FDS4310M	MDS4310M		0.125 [3.18] Ø
	see page 85 for additional information	SHIELDED	FDS4201M	MDS4201M	0.156 [3.96]	SHIELDED
RIGHT ANGLE (90°) PRINTED BOARD MOUNT	see page 83 for additional information	8	FRT4314M	MRT4314M	0.339 [8.61]	0.078 [1.98] Ø
			FRT4414M	MRT4414M	0.451 [11.56]	0.078 [1.98] Ø
			FRT4714M	MRT4714M	0.420 [10.67]	0.078 [1.98] Ø
			FRT4814M	MRT4814M	0.520 [13.21]	0.078 [1.98] Ø
			FRT4310M	MRT4310M	0.810 [20.57]	0.125 [3.18] Ø
			FRT4410M	MRT4410M	0.810 [20.57]	0.125 [3.18] Ø
	see page 85 for additional information	SHIELDED	FRT4201M	MRT4201M	0.162 [6.10]	SHIELDED

**NOTE:** Positronic recommends printed circuit board contacts be supplied factory installed in the connector. Contact technical sales.

For information regarding **REMOVABLE CONTACTS**, see contact illustration drawings and charts on pages 77-85.

For information regarding **CRIMP TOOLS & CRIMPING TOOL TECHNIQUES**, see page 96.



## ORDERING INFORMATION - CODE NUMBERING SYSTEM

Specify Complete Connector By Selecting An Option From Step 1 Through 8

STEP	1	2	3	4	5	6	7	8	9
EXAMPLE	SCBM	17W2	S	55	R7	N	T2	G	
<b>STEP 1 - BASIC SERIES</b> SCBM series									<b>STEP 9 - SPECIAL OPTIONS</b> SEE APPENDIX ON PAGE 95.
<b>STEP 2 - CONNECTOR VARIANTS</b> Shell Size 1 - 2WK2, 5W1 Shell Size 2 - 3W3, 3WK3, 7W2, 11W1 Shell Size 3 - 5W5, 9W4, 13W3, 17W2, 21W1 Shell Size 4 - 8W8, 13W6, 17W5, 21WA4, 25W3, 27W2 Shell Size 5 - 24W7, 36W4, 43W2, 47W1 Shell Size 6 - 46W4									<b>STEP 8 - CONNECTOR HOUSING (SHELLS) OPTION</b> G - Gold over copper plate. D - Gold over copper plate and dimpled ( <i>male connectors only</i> ).
<b>STEP 3 - CONNECTOR GENDER</b> M - Male S - Female - PosiBand closed entry contacts, see page 1 for more information.									<b>*3 STEP 7 - LOCKING AND POLARIZING SYSTEMS</b> 0 - None. T - Fixed female jackscrews. T2 - Fixed female jackscrews. T6 - Fixed male and female polarized jackscrews. E - Rotating male jackscrews. E2 - Rotating male screw locks. E3 - Rotating male with internal hex for 3/32 hex drives. E6 - Rotating male and female polarized jackscrews.
<b>STEP 4 - CONTACT TERMINATION TYPE</b> *10 - Connector ordered without size 8 power shielded or high voltage removable contacts, see contact chart on page 37 for details. 2 - Fixed, solder cup, signal contacts only. 3 - Solder, straight printed board mount with signal contacts only, 0.170 [4.32] tail length. 35 - Solder, straight printed board mount with signal and 0.078 [1.98] Ø power contacts, 0.170 [4.32] tail length. 36 - Solder, straight printed board mount with signal and 0.094 [2.39] Ø power contacts, 0.170 [4.32] tail length. 37 - Solder, straight printed board mount with signal and 0.125 [3.18] Ø power contacts, 0.170 [4.32] tail length. 5 - Solder, right angle (90°) printed board mount with signal contacts only, 0.283 [7.19] signal contact extension. 55 - Solder, right angle (90°) printed board mount with signal and 0.078 [1.98] Ø power contacts, 0.283 [7.19] signal contact extension. 57 - Solder, right angle (90°) printed board mount with signal and 0.125 [3.18] Ø power contacts, 0.283 [7.19] signal contact extension. 65 - Solder, straight printed board mount with signal and shielded contacts, MDS/FDS 4201M footprint, 0.170 [4.32] signal contact tail length. 7 - Solder, metric system right angle (90°) printed board mount with signal contacts only, 0.370 [9.40] signal contact extension. 75 - Solder, metric system right angle (90°) printed board mount with signal and 0.078 [1.98] Ø power contacts, 0.370 [9.40] signal contact extension. 77 - Solder, metric system right angle (90°) printed board mount with signal and 0.125 [3.18] Ø power contacts, 0.370 [9.40] signal contact extension. *2 85 - Solder, right angle (90°) printed board mount with signal and shielded contacts, MRT/FRT 4201M footprint, 0.283 [7.19] signal contact extension.									<b>*3 STEP 6 - CABLE ADAPTER (HOOD) AND PUSH-ON FASTENER</b> 0 - None. H - Cable adapter, top opening, brass. AN - Cable adapter, lightweight aluminum, electroless nickel plate, see page 91 for details. N - Push-on fastener for right angle (90°) mounting brackets.
<b>NOTES:</b> *1 Available on 2WK2, 3W3, 3WK3, 5W5 and 8W8 variants only. *2 Not available on shell size 6, SCBM 46W4. *3 For additional information on accessories listed in Step 5, 6, and 7, see the Accessories section, pages 86-94. *4 Not available on 2WK2, 3W3, 3WK3, 5W5 and 8W8 variants when choosing code 57, 77 or 85 in Step 4. *5 For use with 2WK2, 3W3, 3WK3, 5W5, 8W8 variants when choosing code 57, 77 or 85 in step 4. *6 2WK2, 3W3, 3WK3, 5W5, AND 8W8 variants will be supplied without an alignment bar.									<b>*3 STEP 5 - MOUNTING STYLE</b> 0 - Mounting hole, 0.120 [3.05] Ø. 02 - Mounting hole, 0.154 [3.91] Ø. B3 - Bracket, mounting, right angle (90°) metal with cross bar. C5 - Swaged spacer, cul-de-sac style, 4-40 threads, 0.350 [8.89] length. For use with cable connectors only. *6 C7 - Bracket, mounting, right angle (90°) metal, swaged to connector with cul-de-sac spacer and 4-40 threads with cross bar. F - Float mounts, universal. P - Threaded post, brass, 0.250 [6.35] Length. *5 R - Bracket, mounting, right angle (90°) metal, swaged to connector with 4-40 thread fixed female jackscrews. *4 R2 - Bracket, mounting, right angle (90°) metal, swaged to connector with 4-40 thread fixed female jackscrews with cross bar. *5 R3 - Bracket, mounting, right angle (90°) metal, swaged to connector with 0.120 [3.05] Ø mounting hole. *5 R4 - Bracket, mounting, right angle (90°) metal, swaged to connector with 4-40 threads. *5 R5 - Bracket, mounting, right angle (90°) metal, swaged to connector with 4-40 locknut. *4 R6 - Bracket, mounting, right angle (90°) metal, swaged to connector with 0.120 [3.05] Ø mounting hole with cross bar. *4 R7 - Bracket, mounting, right angle (90°) metal, swaged to connector with 4-40 threads with cross bar. *4 R8 - Bracket, mounting, right angle (90°) metal, swaged to connector with 4-40 locknut with cross bar. S - Swaged spacer, 4-40 threads, 0.250 [6.35] length. S2 - Swaged spacer, 4-40 threads, 0.125 [3.18] length. S5 - Swaged locknut, 4-40 threads. S6 - Swaged spacer with push-on fastener, 4-40 threads, 0.250 [6.35] length.

Do you need 2-D drawings or 3-D models?  
See page 18 for more information!

For information regarding CRIMP TOOLS & CRIMPING TOOL TECHNIQUES, see page 96.

SCBM SERIES



Positronic Industries  
connectpositronic.com

# SCBC SERIES

## MILITARY / SPACE FLIGHT QUALITY

### STANDARD DENSITY REMOVABLE CONTACTS

High  
Performance  
D-sub



- ✓ High performance for use in harsh environments, including space flight.
- ✓ Size 20 and Size 8 **removable** contacts.
- ✓ All female closed entry signal contacts utilize the “PosiBand®” system. *See page 1 for details.* GSFC S-311-P-4/10 offers two contact engagement test options. Size 20 PosiBand contacts meet the higher 40 gram requirements per 4.2.2.b.
- ✓ Sixteen connector variants with a mixture of signal, power, shielded and high voltage contacts.
- ✓ Terminations include cable or wire crimp and solder.
- ✓ Current ratings to 70 amperes.  
*See temperature rise curves on page 3 & 4 for details.*
- ✓ A wide variety of options and accessories.
- ✓ Applicable variants are qualified to GSFC and military specifications. *See page 99 for details.*

#### Conforming To Applicable Material, Dimensional and Performance Requirements:

- GSFC S-311-P4
- DSCC Specification 85039

#### Conforming To Outgassing Requirements:

- ASTM E-595 & NASA-RP-1124

## TECHNICAL CHARACTERISTICS

### MATERIALS AND FINISHES:

<b>Connector Insert:</b>	Glass-filled polyester per ASTM-D-5927, UL 94V-0, ASTM E-595, NASA-RP-1124 blue color.
<b>Contacts:</b>	
<b>Size 20:</b>	Precision machined copper alloy. 0.000050 inch [1.27 microns] gold over copper plate.
<b>Size 8:</b>	
<b>Power:</b>	Precision machined high conductivity copper alloy. 0.000050 inch [1.27 microns] gold over copper plate.
<b>Shielded:</b>	<i>For material and finishes, see page 77.</i>
<b>High Voltage:</b>	<i>For material and finishes, see page 77.</i>

### Connector Housing (Shells):

Brass with 0.000050 inch [1.27 microns] gold over copper plate.

### Mounting Spacers and Brackets:

Brass with 0.000050 inch [1.27 microns] gold over copper plate.

### Jackscrew Systems:

Brass with 0.000050 inch [1.27 microns] gold over copper plate.

### Cable Adapter (Hood):

Brass with 0.000050 inch [1.27 microns] gold over copper plate; aluminum with electroless nickel plate. Other finishes available, contact Technical Sales.

*continued on next page. . .*



## TECHNICAL CHARACTERISTICS, *continued*

*continued from previous page. . .*

### MECHANICAL CHARACTERISTICS:

**Size 20 Removable:** Male contact - 0.040 inch [1.02 mm] mating diameter. Female contact - PosiBand closed entry design; *see page 1 for details. For removable size 20 contacts, see page 79-80.*

**Size 8 Removable:**  
**Power:** Male contact - 0.142 inch [3.61 mm] mating diameter. Female contact - features Large Surface Area (L.S.A.) closed entry design utilizing BeCu mechanical retention member. *For removable size 8 contacts, see pages 81-85.*

**Shielded:** *For mechanical characteristics, see page 77.*

**High Voltage:** *For mechanical characteristics, see page 77.*

### Contact Retention in Connector Insert:

**Size 20:** 9 lbs. [40 N].  
**Size 8 Power / Shielded:** 22 lbs. [98 N].

### Contact Terminations:

**Size 20:** Closed barrel crimp - wire sizes 18 AWG [1.0 mm<sup>2</sup>] through 30 AWG [0.05 mm<sup>2</sup>].  
Closed barrel solder - wire size 20 AWG [0.5 mm<sup>2</sup>] maximum; *see page 80 for details.*

**Size 8:**  
**Power:** Closed barrel crimp or solder cup - wire sizes 8 [10.0 mm<sup>2</sup>], 10 [5.3 mm<sup>2</sup>], 12 [4.0 mm<sup>2</sup>], and 16 [1.5 mm<sup>2</sup>] AWG.

**Shielded:** *Refer to RF Cable in chart on page 84 for contact terminations.*

**High Voltage:** Straight and right angle (90°) terminations 0.041 inch [1.04 mm] minimum hole diameter.

### Connector Housing (Shells):

Male connector housings may be dimpled for EMI/ESD ground paths.

### Polarization:

Trapezoidally-shaped connector housings and polarized jackscrews.

### Locking Systems:

Jackscrews.

### Mechanical Operations:

1,000 operations per IEC 60512-5.

### ELECTRICAL CHARACTERISTICS:

#### SIZE 20 CONTACTS

**Contact Current Rating:** 7.5 amperes, nominal  
**Initial Contact Resistance:** 0.004 ohms maximum.  
**Proof Voltage:** 1000 V r.m.s.

#### SIZE 8 CONTACTS

#### POWER CONTACTS

*For electrical characteristics, see page 21.*

#### SHIELDED CONTACTS

*For electrical characteristics, see page 77.*

#### HIGH VOLTAGE CONTACTS

*For electrical characteristics, see page 77.*

### CONNECTOR

**Insulation Resistance:** 5 G ohms.

### Clearance and

**Creepage Distance:**

0.039 inch [1.0 mm], minimum.

**Working Voltage:**

300 V r.m.s.

### CLIMATIC CHARACTERISTICS:

**Temperature Range:**

-55°C to +125°C.

**Damp Heat, Steady State:**

21 days.

Visit our website for the latest catalog updates and supplements at  
<http://www.connectpositronic.com/products/62/HighPerformanceD-subminiature/catalogs/>



SCBM13W6M55R200D  
(shown left)

SCBC13W6S1000G WITH FC4008M CONTACTS  
(shown right)



Positronic Industries  
connectpositronic.com

# SCBC SERIES

## MILITARY / SPACE FLIGHT QUALITY

### STANDARD DENSITY REMOVABLE CONTACTS

High  
Performance  
D-sub

#### \*1 CONTACT VARIANTS

FACE VIEW OF MALE OR REAR VIEW OF FEMALE

#### NOTES:

\*1 Additional contact variants may be tooled at customer request.

\*2 13W6 and 27W2 variant currently available in female only. Contact Technical Sales for availability of male connector.

#### — SHELL SIZE 1 —

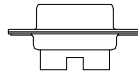
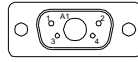

5W1

#### — SHELL SIZE 2 —

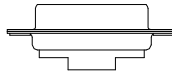
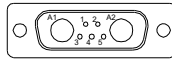

7W2

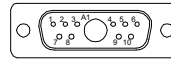

11W1

#### — SHELL SIZE 3 —

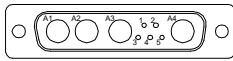

9W4

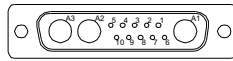

13W3

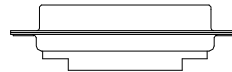
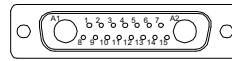

17W2

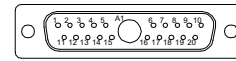

21W1

#### — SHELL SIZE 4 —

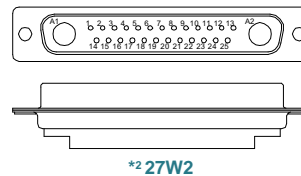
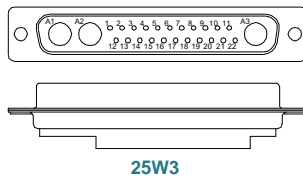
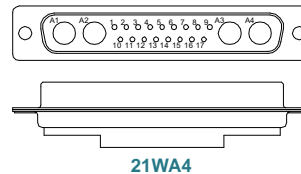
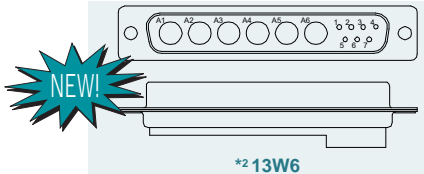

#### — SHELL SIZE 5 —

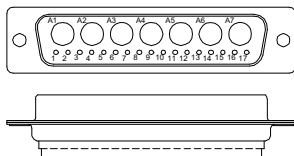

24W7

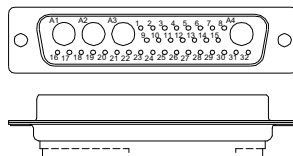

36W4

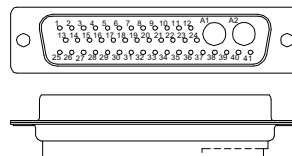

43W2

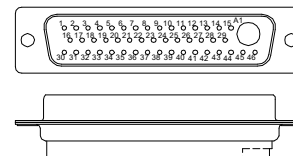

47W1

#### — SHELL SIZE 6 —

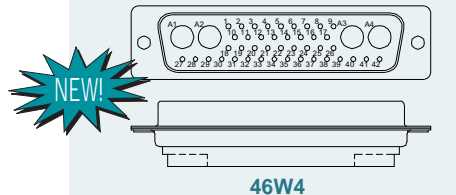





**STANDARD CONNECTOR HOUSING (SHELLS) ASSEMBLY**



SCBC7W2S0000G

SCBC17W2M0000G

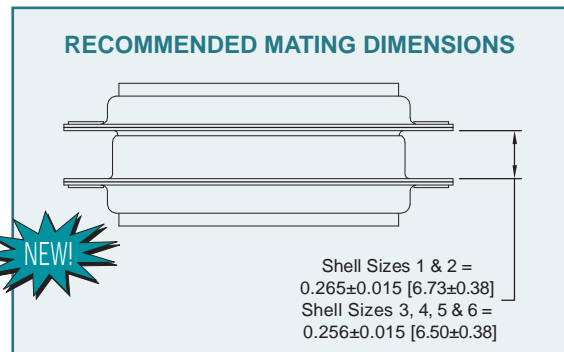

**TYPICAL CONNECTOR TOP VIEW**

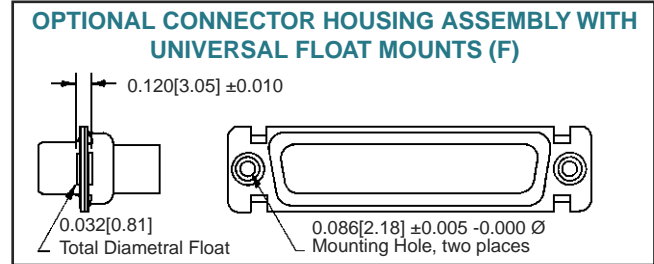
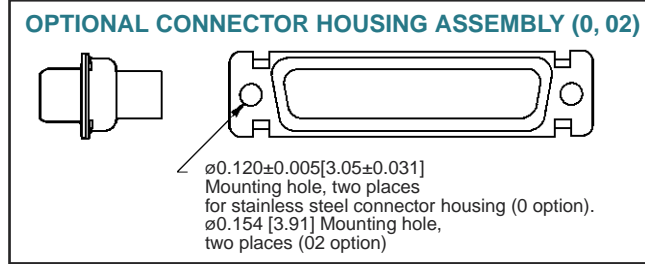
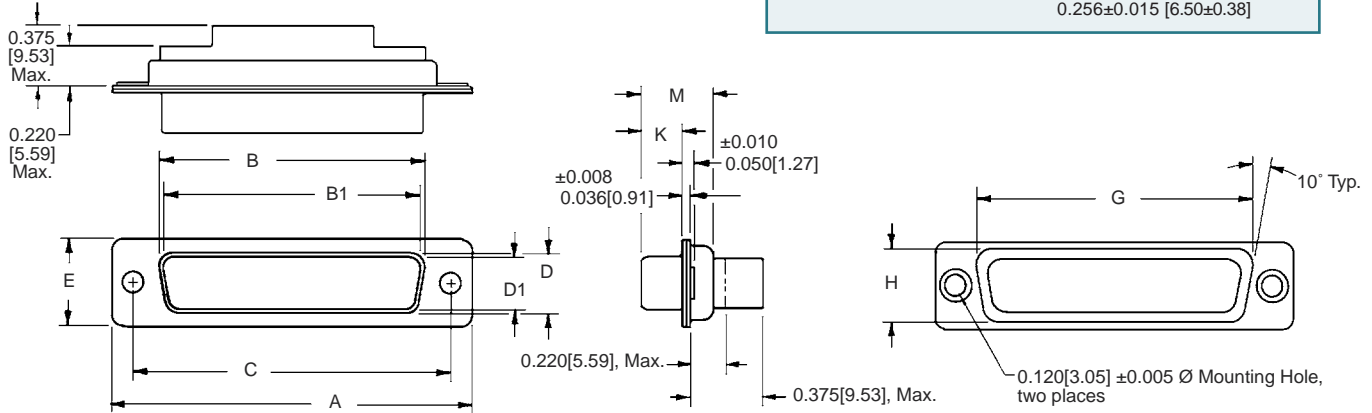

SHELL SIZE	GENDER	A ±0.015 [0.38]	B ±0.005 [0.13]	B1 ±0.005 [0.13]	C ±0.005 [0.13]	D ±0.005 [0.13]	D1 ±0.005 [0.13]	E ±0.015 [0.38]	G ±0.010 [0.25]	H ±0.010 [0.25]	K ±0.005 [0.13]	M ±0.010 [0.25]
1	MALE	1.213 [30.81]		0.666 [16.92]	0.984 [24.99]		0.329 [8.36]	0.494 [12.55]	0.759 [19.28]	0.422 [10.72]	0.233 [5.92]	0.422 [10.72]
	FEMALE	1.213 [30.81]	0.643 [16.33]		0.984 [24.99]	0.311 [7.90]		0.494 [12.55]	0.759 [19.28]	0.422 [10.72]	0.243 [6.17]	0.429 [10.90]
2	MALE	1.541 [39.14]		0.994 [25.25]	1.312 [33.32]		0.329 [8.36]	0.494 [12.55]	1.083 [27.51]	0.422 [10.72]	0.233 [5.92]	0.422 [10.72]
	FEMALE	1.541 [39.14]	0.971 [24.66]		1.312 [33.32]	0.311 [7.90]		0.494 [12.55]	1.083 [27.51]	0.422 [10.72]	0.243 [6.17]	0.429 [10.90]
3	MALE	2.088 [53.04]		1.534 [38.96]	1.852 [47.04]		0.329 [8.36]	0.494 [12.55]	1.625 [41.28]	0.422 [10.72]	0.230 [5.84]	0.426 [10.82]
	FEMALE	2.088 [53.04]	1.511 [38.38]		1.852 [47.04]	0.311 [7.90]		0.494 [12.55]	1.625 [41.28]	0.422 [10.72]	0.243 [6.17]	0.429 [10.90]
4	MALE	2.729 [69.32]		2.182 [55.42]	2.500 [63.50]		0.329 [8.36]	0.494 [12.55]	2.272 [57.71]	0.422 [10.72]	0.230 [5.84]	0.426 [10.82]
	FEMALE	2.729 [69.32]	2.159 [54.84]		2.500 [63.50]	0.311 [7.90]		0.494 [12.55]	2.272 [57.71]	0.422 [10.72]	0.243 [6.17]	0.429 [10.90]
5	MALE	2.635 [66.93]		2.079 [52.81]	2.406 [61.11]		0.441 [11.20]	0.605 [15.37]	2.178 [55.32]	0.534 [13.56]	0.230 [5.84]	0.426 [10.82]
	FEMALE	2.635 [66.93]	2.064 [52.43]		2.406 [61.11]	0.423 [10.74]		0.605 [15.37]	2.178 [55.32]	0.534 [13.56]	0.243 [6.17]	0.429 [10.90]
6	MALE	2.729 [69.32]		2.212 [56.18]	2.500 [63.50]		0.503 [12.78]	0.668 [16.97]	2.302 [58.47]	0.596 [15.14]	0.230 [5.84]	0.426 [10.82]
	FEMALE	2.729 [69.32]	2.189 [55.60]		2.500 [63.50]	0.485 [12.32]		0.668 [16.97]	2.302 [58.47]	0.596 [15.14]	0.243 [6.17]	0.429 [10.90]



## REMOVABLE CONTACT ORDERING ASSISTANCE CHART



### SCBC SERIES CRIMP AND SOLDER TERMINATION CONTACTS

TYPE	PAGE NUMBER REFERENCE IN CATALOG	CONTACT SIZE	FEMALE PART NUMBER	MALE PART NUMBER	WIRE SIZE AWG [mm <sup>2</sup> ]
CRIMP	see page 79 for additional information	20	FC6020M2	MC6020M	20 [0.5] / 22 [0.3] / 24 [0.25]
			FC6026M2	MC6026M	26 [0.12] / 28 [0.08] / 30 [0.5]
			FC6018M2	MC6018M	18 [1.0] max.
	see page 81 for additional information	8	FC4008M	MC4008M	8 [10.0]
			FC4010M	MC4010M	10 [5.3]
			FC4012M	MC4012M	12 [4.0]
			FC4016M	MC4016M	16 [1.5]
SOLDER	see page 80 for additional information	20	FS6020M2	MS6020M	20 [0.5] max.
SOLDER CUP	see page 82 for additional information	8	FS4008M	MS4008M	8 [10.0]
			FS4012M	MS4012M	12 [4.0]
			FS4016M	MS4016M	16 [1.5]
HIGH VOLTAGE <i>Straight Solder Wire</i>	see page 83 for additional information	8	FS4820M	MS4820M	20 [0.5]
HIGH VOLTAGE <i>Right Angle (90°) Solder Wire</i>			FS4920M	MS4920M	20 [0.5]
SHIELDED	see page 84 for additional information	SOLDER / CRIMP	FC4101M	MC4101M	RG 178 B/U, 196 B/U
			FC4102M	MC4102M	RG 179 BU/, 316 B/U
			FC4103M	MC4103M	RG 180 B/U
			FC4104M	MC4104M	RG 58 B/U
		SOLDER / SOLDER	FS4101M	MS4101M	RG 178 B/U, 196 B/U
			FS4102M	MS4102M	RG 179 B/U, 316 B/U
			FS4103M	MS4103M	RG 180 B/U
			FS4104M	MS4104M	RG 58 B/U
		CRIMP / CRIMP	FCC4101M	MCC4101M	RG 178 B/U, 196 B/U
			FCC4102M	MCC4102M	RG 179 BU/, 316 B/U
			FCC4103M	MCC4103M	RG 180 B/U
			FCC4104M	MCC4104M	RG 58 B/U

**NOTE:** For ordering crimp contacts on reels, add "R" to part number, see page 77 for details. Examples: FC4008MR or MC4008MR

For information regarding **REMOVABLE CONTACTS**, see contact illustration drawings and charts on pages 77-85.

For information regarding **CRIMP TOOLS & CRIMPING TOOL TECHNIQUES**, see page 96.



## ORDERING INFORMATION - CODE NUMBERING SYSTEM

Specify Complete Connector By Selecting An Option From Step 1 Through 8

STEP	1	2	3	4	5	6	7	8	9
EXAMPLE	SCBC	7W2	M	14	0	0	E	D	

### STEP 1 - BASIC SERIES

SCBC Series

### \*4 STEP 2 - CONNECTOR VARIANTS

#### Shell Size 1

5W1

#### Shell Size 2

7W2, 11W1

#### Shell Size 3

9W4, 13W3, 17W2, 21W1

#### Shell Size 4

\*113W6, 21WA4, 25W3, \*127W2

#### Shell Size 5

24W7, 36W4, 43W2, 47W1

#### Shell Size 6

46W4

### STEP 3 - CONNECTOR GENDER

M - Male

S - Female - PosiBand closed entry contacts,  
see page 1 for more information.

### STEP 4 - CONTACT TERMINATION TYPE

0 - Contacts ordered separately, see contact chart on page 43 for details.

\*3 1 - Signal contacts, 20 AWG - 24 AWG [0.5mm<sup>2</sup>-0.25mm<sup>2</sup>].

\*3 11 - Signal contacts, 20 AWG - 24 AWG [0.5mm<sup>2</sup>-0.25mm<sup>2</sup>] with MC/FC 4012M power contact.

\*3 12 - Signal contacts, 20 AWG - 24 AWG [0.5mm<sup>2</sup>-0.25mm<sup>2</sup>] with MC/FC 4016M power contact

\*3 13 - Signal contacts, 20 AWG - 24 AWG [0.5mm<sup>2</sup>-0.25mm<sup>2</sup>] with MCC/FCC 4101M shielded contacts.

\*3 14 - Signal contacts, 20 AWG - 24 AWG [0.5mm<sup>2</sup>-0.25mm<sup>2</sup>] with MCC/FCC 4102M shielded contacts.

### \*2 STEP 5 - MOUNTING STYLE

0 - Mounting hole, 0.120 [3.05] Ø.

02 - Mounting hole, 0.154 [3.91] Ø.

C5 - Swaged spacer, cul-de-sac style, 4-40 threads, 0.350 [8.89] length.

F - Float mounts, universal.

S2 - Swaged spacer, 4-40 threads, 0.125 [3.18] Length.

S5 - Swaged locknut, 4-40 threads.

### STEP 9 - SPECIAL OPTIONS

SEE APPENDIX ON PAGE 95.

### STEP 8 - CONNECTOR HOUSING (SHELLS) OPTION

G - Gold over copper plate.

D - Gold over copper plate and dimpled  
(male connectors only).

### \*2 STEP 7 - LOCKING AND POLARIZING SYSTEMS

0 - None.

T - Fixed female jackscrews.

T2 - Fixed female jackscrews.

T6 - Fixed male and female polarized jackscrews.

E - Rotating male jackscrews.

E2 - Rotating male screw locks.

E3 - Rotating male with internal hex for 3/32 hex drives

E6 - Rotating male and female polarized jackscrews.

### \*2 STEP 6 - CABLE ADAPTER (HOOD)

0 - None.

H - Cable adapter, top opening, brass.

AN - Cable adapter, lightweight aluminum, electroless nickel plate, see page 91 for details.

### NOTE:

\*1 13W6 and 27W2 variant currently available in female only. Contact Technical Sales for availability of male connector.

\*2 For additional information on accessories listed in Step 5, 6, and 7, see the Accessories section, pages 86-94.

\*3 Kitted contacts are supplied in sealed bags.

\*4 See SCBM series for removable contact versions of 2WK2, 3W3, 3WK3, 5W5 and 8W8 variants.

*Do you need 2-D drawings or 3-D models?*

See page 18 for more information!

For information regarding CRIMP TOOLS & CRIMPING TOOL TECHNIQUES, see page 96.



Positronic Industries  
connectpositronic.com



# SCBDD SERIES

## MILITARY / SPACE FLIGHT QUALITY

### HIGH DENSITY PCB MOUNT

High  
Performance  
D-sub



- ✓ High performance for use in harsh environments, including space flight.
- ✓ Size 22 **fixed** contacts, Size 16 **fixed** contacts and Size 8 **removable** contacts.
- ✓ All female closed entry signal contacts utilize the “PosiBand®” system. *See page 1 for details.* GSFC S-311-P-4/08 offers two contact engagement test options. Size 22 PosiBand contacts meet the higher 40 gram requirements per 4.2.2.b.
- ✓ Four connector variants with a mixture of signal, power, shielded and high voltage contacts.
- ✓ Terminations include cable or wire crimp and solder, straight and right angle PCB mount.
- ✓ Current ratings to 70 amperes.  
*See temperature rise curves on page 3 & 4 for details.*
- ✓ A wide variety of options and accessories.

### Conforming To Applicable Material, Dimensional and Performance Requirements:

- GSFC S-311-P4 & GSFC S-311-P10
- DSCC Specification 85039

### Conforming To Outgassing Requirements:

- ASTM E-595 & NASA-RP-1124

## TECHNICAL CHARACTERISTICS

### MATERIALS AND FINISHES:

<b>Connector Insert:</b>	Glass-filled polyester per ASTM-D-5927, UL 94V-0, ASTM E-595, NASA-RP-1124 blue color.	<b>Shielded:</b>	<i>For material and finishes, see page 77.</i>
<b>Contacts:</b>		<b>High Voltage:</b>	<i>For material and finishes, see page 77.</i>
<b>Size 22:</b>	Precision machined copper alloy. 0.000050 inch [1.27 microns] gold over copper plate. Other finishes are available; see page 95.	<b>Connector Housing (Shells):</b>	Brass with 0.000050 inch [1.27 microns] gold over copper plate.
<b>Size 16:</b>	Precision machined high conductivity copper alloy. 0.000050 inch [1.27 microns] gold over copper plate. Other finishes are available; see page 95.	<b>Mounting Spacers and Brackets:</b>	Brass with 0.000050 inch [1.27 microns] gold over copper plate.
<b>Size 8:</b>		<b>Push-On Fasteners:</b>	Phosphor bronze or beryllium copper with 0.000050 inch [1.27 microns] gold over copper plate.
<b>Power:</b>	Precision machined high conductivity copper alloy. 0.000050 inch [1.27 microns] gold over copper plate. Other finishes are available; see page 95.	<b>Jackscrew Systems:</b>	Brass with 0.000050 inch [1.27 microns] gold over copper plate.
		<b>Cable Adapter (Hood):</b>	Brass with 0.000050 inch [1.27 microns] gold over copper plate; aluminum with electroless nickel plate. Other finishes available, contact Technical Sales.

*continued on next page. . .*



## TECHNICAL CHARACTERISTICS, *continued*

*continued from previous page. . .*

### MECHANICAL CHARACTERISTICS:

<b>Size 22 Fixed:</b>	Male – 0.030 inch [0.76 mm] mating diameter. Female contact - PosiBand closed entry design; <i>see page 1 for details.</i>
<b>Size 16 Fixed:</b>	Male – 0.062 inch [1.57 mm] mating diameter. Female contact - PosiBand closed entry design; <i>see page 1 for details.</i>
<b>Size 8 Removable:</b>	Male – 0.142 inch [3.61mm] mating diameter. Female contact features Large Surface Area (L.S.A.) closed entry contact design utilizing BeCu mechanical retention member.
<b>Shielded:</b>	<i>For mechanical characteristics, see page 77.</i>
<b>High Voltage:</b>	<i>For mechanical characteristics, see page 77.</i>

### Contact Retention in Connector Insert:

<b>Size 22:</b>	5 lbs. [21N] minimum.
<b>Size 16 Power:</b>	6 lbs. [26N] minimum.
<b>Size 8 Power / Shielded:</b>	22 lbs. [98N].

<b>Resistance to Solder Iron Heat:</b>	500°F [260°C] for 10 seconds duration per IEC 60512-6.
--	--

### Contact Terminations:

<b>Size 22:</b>	Solder cup - wire size 22 AWG [0.25 mm <sup>2</sup> ] maximum. Straight solder printed board mount - 0.020 inch [0.51 mm] termination diameter. Right angle (90°) printed board mount - 0.030 inch [0.76 mm] termination diameter.
<b>Size 16:</b>	Solder cup - wire size 22 AWG [0.25 mm <sup>2</sup> ] maximum. Straight solder printed board mount - 0.063 inch [1.60 mm] termination diameter. Right angle (90°) printed board mount - 0.062 inch [0.76 mm] termination diameter.
<b>Size 8:</b>	
<b>Power:</b>	Closed barrel crimp or solder cup - wire sizes 8 [10.0 mm <sup>2</sup> ], 10 [5.3 mm <sup>2</sup> ], 12 [4.0 mm <sup>2</sup> ], and 16 [1.5 mm <sup>2</sup> ] AWG. Straight solder printed board mount - 0.078 inch [1.98 mm], 0.094 inch [2.39 mm] and 0.125 inch [3.18 mm] termination diameters. Right angle (90°) printed board mount - 0.078 inch [1.98 mm] and 0.125 inch [3.18 mm] termination diameters.
<b>Shielded:</b>	<i>Refer to RF Cable in chart on page 84 for contact terminations.</i>

<b>High Voltage:</b>	Straight and right angle (90°) terminations 0.041 inch [1.04 mm] minimum hole diameter.
----------------------	---

<b>Connector Housing (Shells):</b>	Male connector housings may be dimpled for EMI/ESD ground paths.
------------------------------------	--

<b>Polarization:</b>	Trapezoidally-shaped connector housing and polarized jackscrews.
----------------------	--

<b>Mounting to Angle Brackets:</b>	Jackscrews and riveted fasteners with 0.120 inch [3.05 mm] diameter hole, and threaded riveted fasteners with 4-40 threads and polyester inserts.
------------------------------------	---

<b>Mounting to Printed Board:</b>	Rapid installation push-on fasteners and threaded posts.
-----------------------------------	--

<b>Locking Systems:</b>	Jackscrews.
-------------------------	-------------

<b>Mechanical Operations:</b>	1,000 operations per IEC 60512-5.
-------------------------------	-----------------------------------

### ELECTRICAL CHARACTERISTICS:

#### SIZE 22 CONTACTS

<b>Contact Current Rating:</b>	5 amperes, nominal
<b>Initial Contact Resistance:</b>	0.005 ohms maximum.
<b>Proof Voltage:</b>	1000 V r.m.s.

#### SIZE 16 CONTACTS

<b>Contact Current Rating, Tested per UL 1977:</b>	28 amperes <i>See temperature rise curves on page 4 for details.</i>
<b>Initial Contact Resistance:</b>	0.0016 ohms maximum, per IEC 60512-2, Test 2b.
<b>Proof Voltage:</b>	1000 V r.m.s.

#### SIZE 8 CONTACTS

##### POWER CONTACTS

*For electrical characteristics, see page 21.*

##### SHIELDED CONTACTS

*For electrical characteristics, see page 77.*

##### HIGH VOLTAGE CONTACTS

*For electrical characteristics, see page 77.*

#### CONNECTOR

<b>Insulation Resistance:</b>	5 G ohms.
<b>Clearance and Creepage Distance:</b>	0.042 inch [1.06 mm], minimum.
<b>Working Voltage:</b>	300 V r.m.s.

### CLIMATIC CHARACTERISTICS:

<b>Temperature Range:</b>	-55°C to +125°C.
<b>Damp Heat, Steady State:</b>	10 days.

Visit our website for the latest catalog updates and supplements at  
<http://www.connectpositronic.com/products/62/HighPerformanceD-subminiature/catalogs/>



Positronic Industries  
connectpositronic.com



# SCBDD SERIES

## MILITARY / SPACE FLIGHT QUALITY

### HIGH DENSITY PCB MOUNT

High  
Performance  
D-sub

### STANDARD CONNECTOR HOUSING (SHELLS) ASSEMBLY



SCBDD8W2M3S00G

SCBDD45W2M3000G

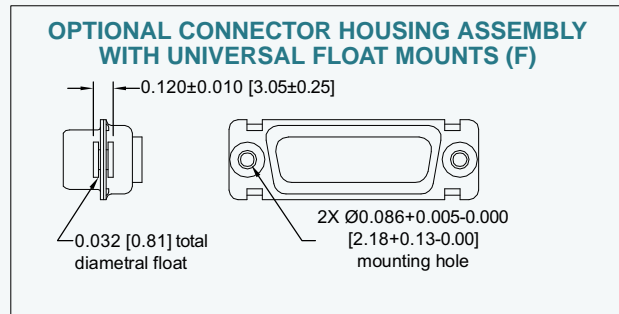
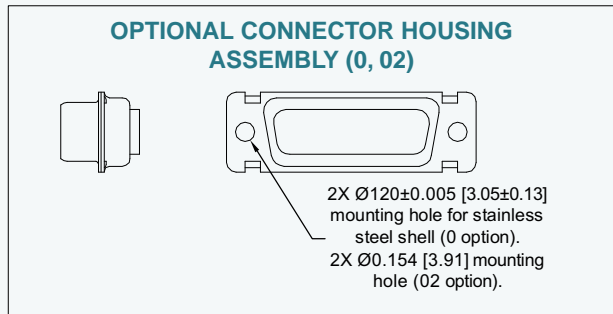
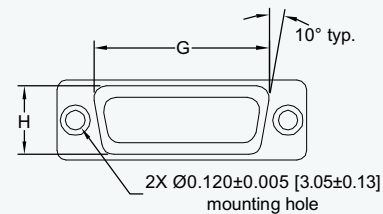
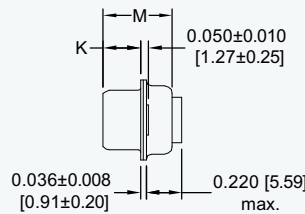
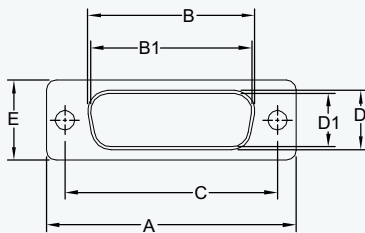
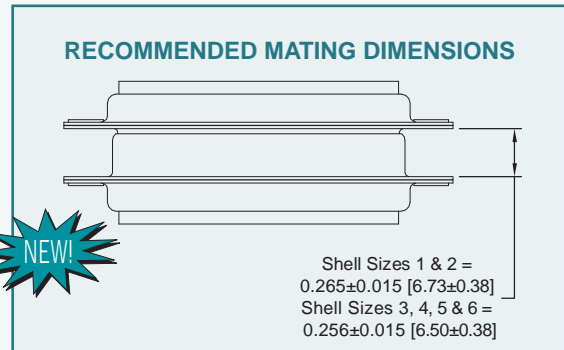

SHELL SIZES	VARIANT	A ±0.015 [0.38]	B ±0.005 [0.13]	B1 ±0.005 [0.13]	C ±0.005 [0.13]	D ±0.005 [0.13]	D1 ±0.005 [0.13]	E ±0.015 [0.38]	G ±0.010 [0.25]	H ±0.010 [0.25]	K ±0.005 [0.13]	M ±0.010 [0.25]
1	8W2M	1.213 [30.81]		0.666 [16.92]	0.984 [24.99]		0.329 [8.36]	0.494 [12.55]	0.759 [19.28]	0.422 [10.72]	0.233 [5.92]	0.422 [10.72]
	8W2S	1.213 [30.81]	0.643 [16.33]		0.984 [24.99]	0.311 [7.90]		0.494 [12.55]	0.759 [19.28]	0.422 [10.72]	0.243 [6.17]	0.429 [10.90]
2	19W1M	1.541 [39.14]		0.994 [25.25]	1.312 [33.32]		0.329 [8.36]	0.494 [12.55]	1.083 [27.51]	0.422 [10.72]	0.233 [5.92]	0.422 [10.72]
	19W1S	1.541 [39.14]	0.971 [24.66]		1.312 [33.32]	0.311 [7.90]		0.494 [12.55]	1.083 [27.51]	0.422 [10.72]	0.243 [6.17]	0.429 [10.90]
3	15W4M	2.088 [53.04]		1.534 [38.96]	1.852 [47.04]		0.329 [8.36]	0.494 [12.55]	1.625 [41.28]	0.422 [10.72]	0.230 [5.84]	0.426 [10.82]
	15W4S	2.088 [53.04]	1.511 [38.38]		1.852 [47.04]	0.311 [7.90]		0.494 [12.55]	1.625 [41.28]	0.422 [10.72]	0.243 [6.17]	0.429 [10.90]
4	45W2M	2.729 [69.32]		2.182 [55.42]	2.500 [63.50]		0.329 [8.36]	0.494 [12.55]	2.272 [57.71]	0.422 [10.72]	0.230 [5.84]	0.426 [10.82]

DIMENSIONS ARE IN INCHES [MILLIMETERS].  
ALL DIMENSIONS ARE SUBJECT TO CHANGE.



**\*1 CONTACT VARIANTS**

FACE VIEW OF MALE OR REAR VIEW OF FEMALE

— SHELL SIZE 1 —

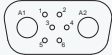

**8W2**

Six (6) Size 22 Signal Contacts and  
Two (2) Size 16 Power Contacts

— SHELL SIZE 2 —

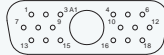

**19W1**

Eighteen (18) Size 22 Signal Contacts  
and One (1) Size 8 Power Contact

— SHELL SIZE 3 —



**15W4**

Eleven (11) Size 22 Signal Contacts  
and Four (4) Size 8 Power Contacts

— SHELL SIZE 4 —

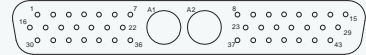

**\*2 45W2**

Forty-three (43) Size 22 Signal Contacts  
and Two (2) Size 8 Power Contacts

**NOTES:**

\*1 Additional contact variants may be tooled at customer request.

\*2 45W2 variant currently available in male only. Contact Technical Sales for availability of female connector.

OTHER VARIANTS WILL BE ADDED, CONSULT OUR WEBSITE  
OR CONTACT TECHNICAL SALES FOR UPDATED INFORMATION.

**SOLDER CUP TERMINATION  
CODE 21**

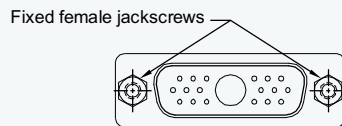
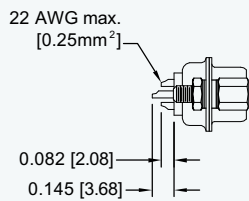

For solder cup contacts,  
specify code 21 in step 4 of  
ordering information.

**TYPICAL PART NUMBER:  
SCBDD19W1M2100T2G**

Fixed female jackscrew      Fixed male jackscrew

Fixed male and female polarized jackscrews available.  
Specify code T6 in step 7 of ordering information.

**TYPICAL PART NUMBER:  
SCBDD19W1M2100T6G**



Positronic Industries  
connectpositronic.com



# SCBDD SERIES

## MILITARY / SPACE FLIGHT QUALITY

### HIGH DENSITY PCB MOUNT

High  
Performance  
D-sub

### STRAIGHT SOLDER PRINTED BOARD MOUNT TERMINATION CODE 3, 35, 36, AND 37

FOR VARIANTS INCLUDING SIZE 16 CONTACTS	
*1 CONTACT NUMBER	D Ø
3	0.063 [1.60]

**NOTE:**

\*1 Contact termination code as specified in Step 4 of ordering information.

FOR VARIANTS WITH SIZE 8 CAVITY	
*1 CONTACT NUMBER	D Ø
3	Size 8 contacts not supplied
35	0.078 [1.98]
36	0.094 [2.39]
37	0.125 [3.18]

**NOTE:**

\*1 Contact termination code as specified in Step 4 of ordering information.

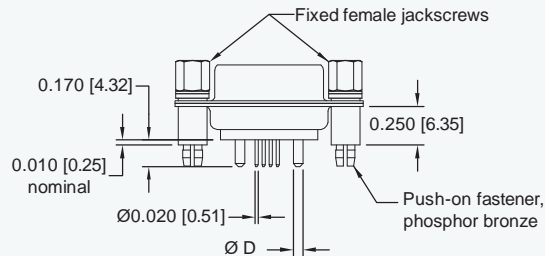

**Typical Part Number: SCBDD8W2S3S60T2G**

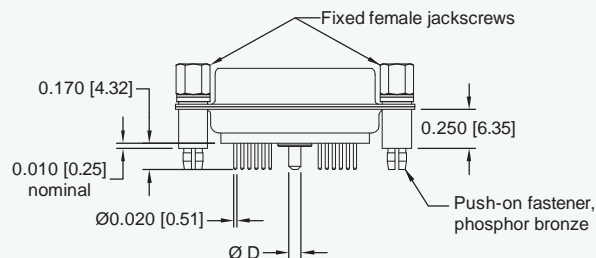

**TYPICAL PART NUMBER:  
SCBDD19W1S35S60T2G**

### RIGHT ANGLE (90°) PRINTED BOARD MOUNT TERMINATION SIZE 16 POWER CONTACTS WITH 0.062 [1.57] Ø TERMINATIONS CODE 4, 0.314 [7.98] CONTACT EXTENSION

See temperature rise curves on pages 3 and 4

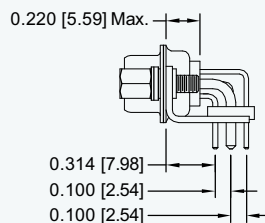
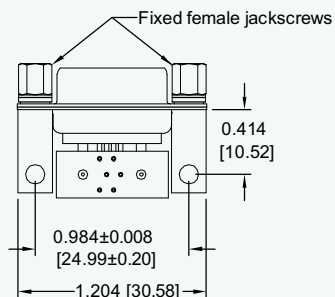
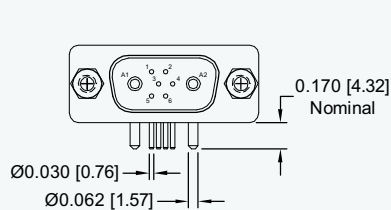

**TYPICAL PART NUMBER:  
SCBDD8W2M4R70T2G**





**RIGHT ANGLE (90°) PRINTED BOARD MOUNT TERMINATION**  
**SIZE 8 POWER CONTACTS WITH 0.078 [1.98] Ø TERMINATIONS**  
**CODE 4 AND 45, 0.314 [7.98] CONTACT EXTENSION**

See temperature rise curves on pages 3 and 4

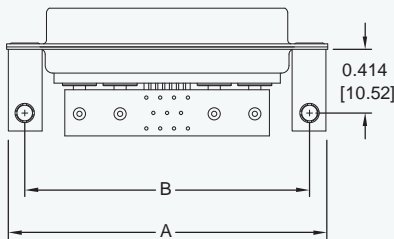
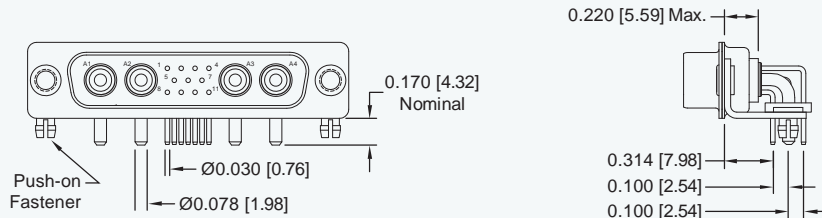

**TYPICAL PART NUMBER:**  
**SCBDD15W4M45R7N0G**

SCBDD**(4 or 45)**** 0.314 [7.98] CONTACT EXTENSION		
SHELL SIZE	A	B
SHELL SIZE 2	1.532 [38.91]	1.312 [33.32]
SHELL SIZE 3	2.072 [52.63]	1.852 [47.04]
SHELL SIZE 4	2.720 [69.09]	2.500 [63.50]

**RIGHT ANGLE (90°) PRINTED BOARD MOUNT TERMINATION**  
**SIZE 8 POWER CONTACTS WITH 0.125 [3.18] Ø TERMINATIONS**  
**CODE 4 AND 47, 0.314 [7.98] CONTACT EXTENSION**

See temperature rise curves on pages 3 and 4

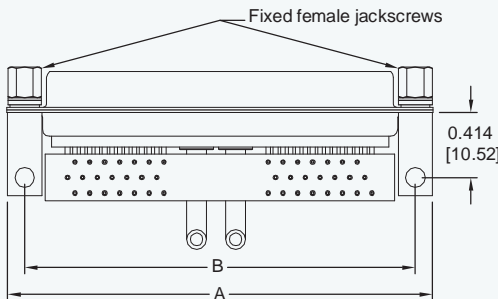
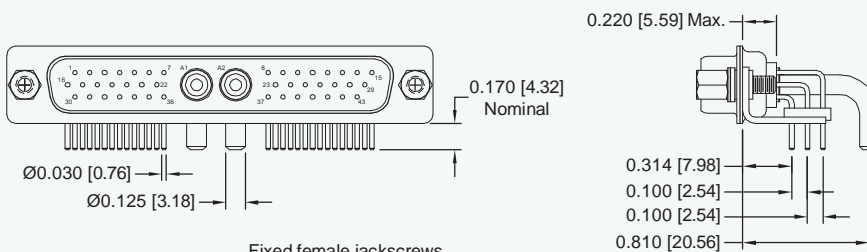

**TYPICAL PART NUMBER:**  
**SCBDD45W2M47R70T2G**

SCBDD**(4 or 47)**** 0.314 [7.98] CONTACT EXTENSION		
SHELL SIZE	A	B
SHELL SIZE 2	1.532 [38.91]	1.312 [33.32]
SHELL SIZE 3	2.072 [52.63]	1.852 [47.04]
SHELL SIZE 4	2.720 [69.09]	2.500 [63.50]



Positronic Industries  
connectpositronic.com



# SCBDD SERIES

## MILITARY / SPACE FLIGHT QUALITY

### HIGH DENSITY PCB MOUNT

High  
Performance  
D-sub

### STRAIGHT SOLDER PRINTED BOARD MOUNT TERMINATION WITH FDS4201M OR MDS4201M SHIELDED CONTACTS CODE 65

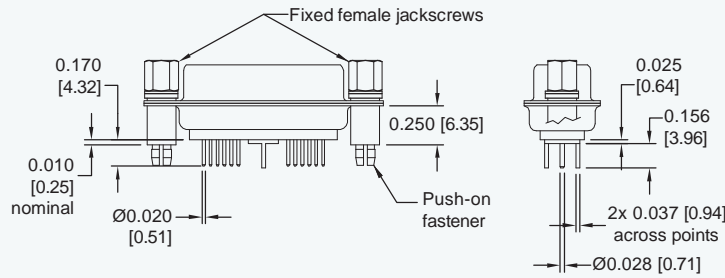

TYPICAL PART NUMBER:  
SCBDD19W1M65S60T2G

Shielded contacts only  
visible this view for clarity

### RIGHT ANGLE (90°) PRINTED BOARD MOUNT TERMINATION WITH FRT4201M OR MRT4201M SHIELDED CONTACTS CODE 84

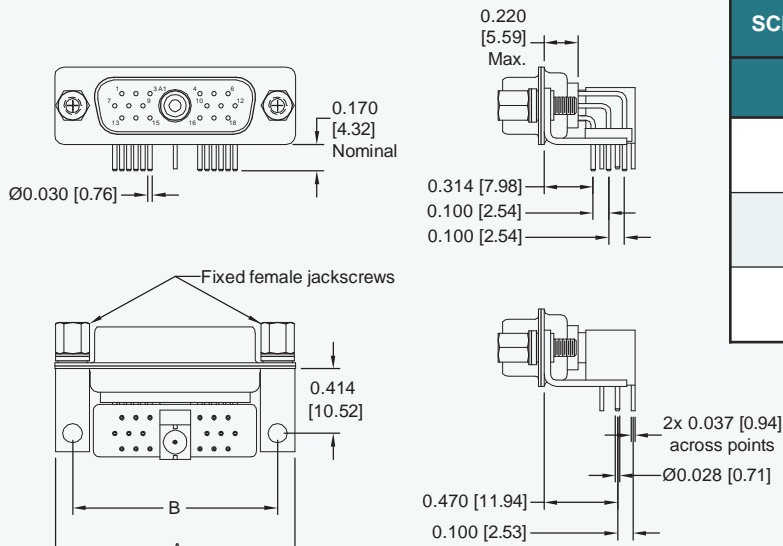

TYPICAL PART NUMBER:  
SCBDD19W1M84R70T2G

Shielded contacts only  
visible this view for clarity

SCBDD\*\*\*84\*\*\*\* 0.314 [7.98] CONTACT EXTENSION

SHELL SIZE	A	B
SHELL SIZE 2	1.532 [38.91]	1.312 [33.32]
SHELL SIZE 3	2.072 [52.63]	1.852 [47.04]
SHELL SIZE 4	2.720 [69.09]	2.500 [63.50]



**PRINTED BOARD MOUNT CONTACT HOLE PATTERN**

HOLE IDENTIFICATION SHOWN FOR MALE CONNECTOR; USE MIRROR IMAGE FOR FEMALE CONNECTOR.  
MOUNT RIGHT ANGLE (90°) CONNECTOR WITH MATING FACE POSITIONED TO FOLLOW DIRECTION OF ARROWS.

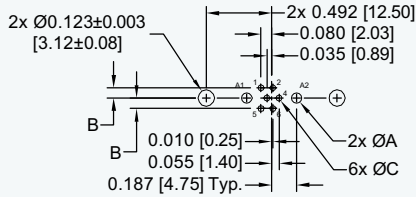

**SCBDD8W2M3**  
**SCBDD8W2M4**

**SUGGESTED PRINTED BOARD HOLE SIZES:**

See Suggested Printed Board Hole Size chart on page 53.

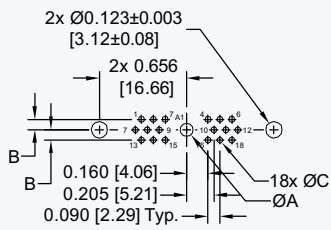

**SCBDD19W1M3, 35, 36, 37**  
**SCBDD19W1M4, 45**

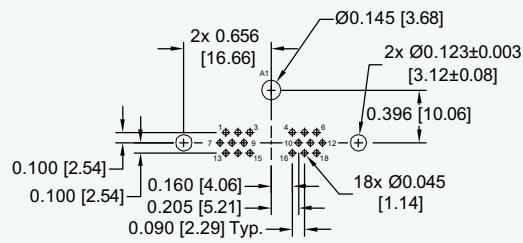

**SCBDD19W1M47**

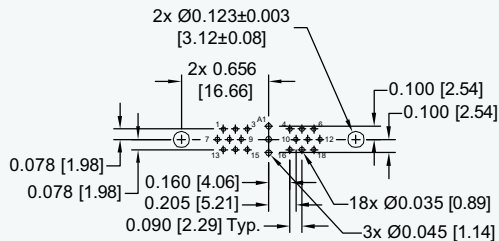

**SCBDD19W1M65**

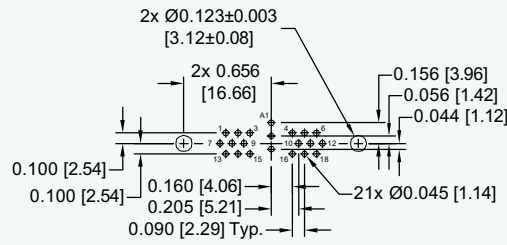

**SCBDD19W1M84**

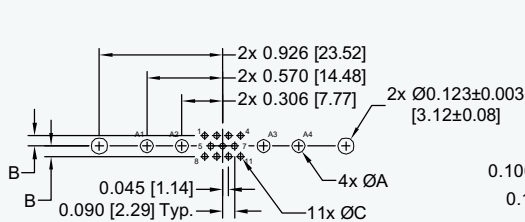

**SCBDD15W4M3, 35, 36, 37**  
**SCBDD15W4M4, 45**

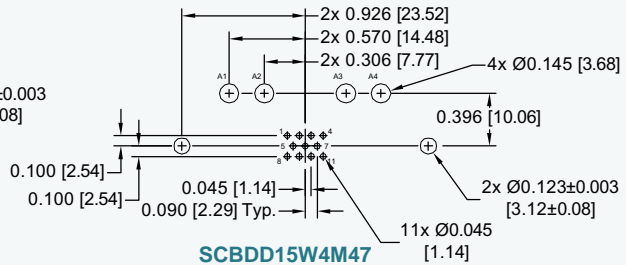

**SCBDD15W4M47**

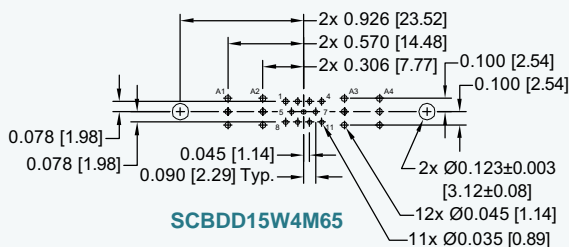

**SCBDD15W4M65**

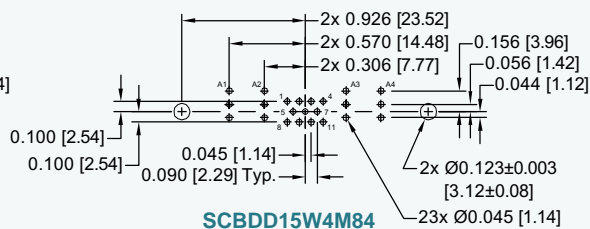

**SCBDD15W4M84**

*continued on next page. . .*



Positronic Industries  
connectpositronic.com



# SCBDD SERIES

## MILITARY / SPACE FLIGHT QUALITY

### HIGH DENSITY PCB MOUNT

High  
Performance  
D-sub

### PRINTED BOARD MOUNT CONTACT HOLE PATTERN

HOLE IDENTIFICATION SHOWN FOR MALE CONNECTOR; USE MIRROR IMAGE FOR FEMALE CONNECTOR.  
MOUNT RIGHT ANGLE (90°) CONNECTOR WITH MATING FACE POSITIONED TO FOLLOW DIRECTION OF ARROWS.

continued from previous page. . .

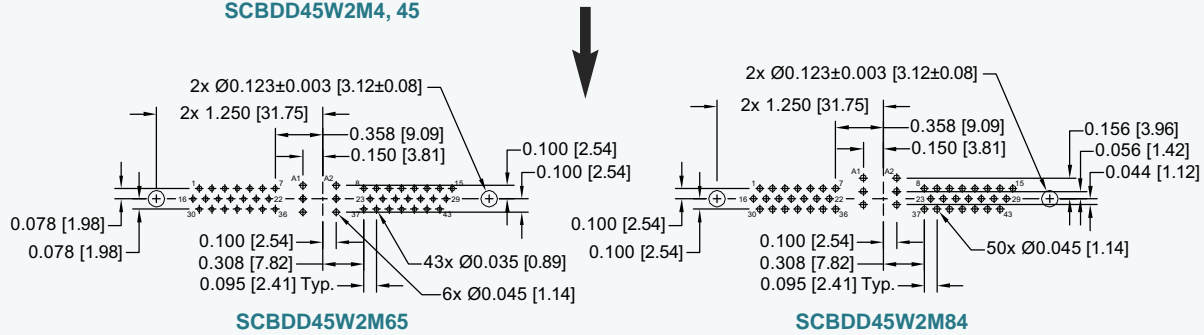
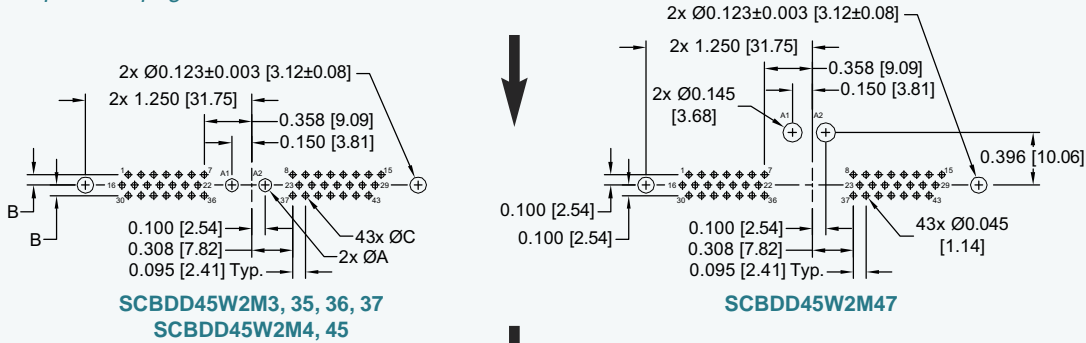

### SUGGESTED PRINTED BOARD HOLE SIZES

VARIANT	CODE	ØA	B	ØC
8W2	3	0.080 [2.03]	0.078 [1.98]	0.035 [0.89]
	4	0.080 [2.03]	0.100 [2.54]	0.045 [1.14]
19W1	3, 35	0.098 [2.49]	0.078 [1.98]	0.035 [0.89]
	36	0.114 [2.90]		
	37	0.145 [3.68]		
15W4	4	N/A	0.100 [2.54]	0.045 [1.14]
45W2	45	0.098 [2.49]	0.100 [2.54]	0.045 [1.14]
	47	N/A	N/A	N/A
	65	N/A	N/A	N/A
	84	N/A	N/A	N/A



**ORDERING INFORMATION - CODE NUMBERING SYSTEM**

Specify Complete Connector By Selecting An Option From Step 1 Through 8

**FOR CONNECTORS**  
**NOT INCLUDING SIZE 8 CONTACTS**

STEP	1	2	3	4	5	6	7	8	9
EXAMPLE	SCBDD	8W2	S	3	S6	0	T2	G	—

**STEP 1 - BASIC SERIES**

SCBDD Series

**STEP 2 - CONNECTOR VARIANTS**

Shell Size 1 - 8W2

See page 56 for ordering information for other shell size options.

**STEP 3 - CONNECTOR GENDER**

M - Male

S - Female - PosiBand closed entry contacts, see page 1 for more information.

**STEP 4 - CONTACT TERMINATION TYPE**

\*1 21 – Fixed, solder cup.

\*1 3 – Solder, straight printed board mount, 0.170 [4.32] tail length.

\*1 4 – Solder, right angle (90°) printed board mount, 0.314 [7.98] signal contact extension.

**\*2 STEP 5 - MOUNTING STYLE**

0 – Mounting hole, 0.120 [3.05] Ø

02 – Mounting hole, 0.154 [3.91] Ø

C5 – Swaged spacer, cul-de-sac style, 4-40 threads, 0.350 [8.89] length. For use with cable connectors only.

C7 – Bracket, mounting, right angle (90°) metal, swaged to connector with cul-de-sac spacer and 4-40 threads with cross bar.

F – Float mounts, universal

P – Threaded post, brass, 0.250 [6.35] length

R2 – Bracket, mounting, right angle (90°) metal, swaged to connector with 4-40 thread fixed female jackscrews with cross bar

R6 – Bracket, mounting, right angle (90°) metal, swaged to connector with 0.120 [3.05] Ø mounting hole with cross bar

R7 – Bracket, mounting, right angle (90°) metal, swaged to connector with 4-40 threads with cross bar

R8 – Bracket, mounting, right angle (90°) metal, swaged to connector with 4-40 locknut with cross bar

S – Swaged spacer, 4-40 threads, 0.250 [6.35] length

S2 – Swaged spacer, 4-40 threads, 0.125 [3.18] length

S5 – Swaged locknut, 4-40 threads

S6 – Swaged spacer with push-on fastener, 4-40 threads, 0.250 [6.35] length

**STEP 9 - SPECIAL OPTIONS**

SEE APPENDIX ON PAGE 95.

**STEP 8 - CONNECTOR HOUSING (SHELLS) OPTION**

G - Gold over copper plate.

D - Gold over copper plate and dimpled (male connectors only).

**\*2 STEP 7 - LOCKING AND POLARIZING SYSTEMS**

0 – None.

T – Fixed female jackscrews.

T2 – Fixed female jackscrews.

T6 – Fixed male and female polarized jackscrews.

E – Rotating male jackscrews.

E2 – Rotating male screw locks.

E3 – Rotating male with internal hex for 3/32 hex drives.

E6 – Rotating male and female polarized jackscrews.

**\*2 STEP 6 - CABLE ADAPTER (HOOD) AND PUSH-ON FASTENER**

0 – None

AN – Cable adapter, lightweight aluminum, electroless nickel plate, see page 91 for details.

H – Cable adapter, top opening, brass

N – Push-on fastener, for right angle (90°) mounting brackets

**NOTES**

\*1 Size 16 power contacts are included when used on 8W2 variant in Step 2.

\*2 For additional information of options listed in steps 5, 6, and 7, see Accessories Section on pages 86-94.

*Do you need 2-D drawings or 3-D models?*

See page 18 for more information!



Positronic Industries  
connectpositronic.com



# SCBDD SERIES

MILITARY / SPACE FLIGHT QUALITY  
HIGH DENSITY PCB MOUNT

High  
Performance  
D-sub

## REMOVABLE CONTACT ORDERING ASSISTANCE CHART



### SCBDD SERIES CRIMP AND SOLDER CUP TERMINATION CONTACTS

TYPE	PAGE NUMBER REFERENCE IN CATALOG	CONTACT SIZE	FEMALE PART NUMBER	MALE PART NUMBER	WIRE SIZE AWG [mm <sup>2</sup> ]
CRIMP	see page 81 for additional information	8	FC4008M	MC4008M	8 [10.0]
			FC4010M	MC4010M	10 [5.3]
			FC4012M	MC4012M	12 [4.0]
			FC4016M	MC4016M	16 [1.5]
SOLDER CUP	see page 82 for additional information	8	FS4008M	MS4008M	8 [10.0]
			FS4012M	MS4012M	12 [4.0]
			FS4016M	MS4016M	16 [1.5]
HIGH VOLTAGE <i>Straight Solder Wire</i>	see page 83 for additional information	8	FS4820M	MS4820M	20 [0.5]
HIGH VOLTAGE <i>Right Angle (90°) Solder Wire</i>		8	FS4920M	MS4920M	20 [0.5]
SHIELDED	see page 84 for additional information	SOLDER / CRIMP	FC4101M	MC4101M	RG 178 B/U, 196 B/U
			FC4102M	MC4102M	RG 179 BU/, 316 B/U
			FC4103M	MC4103M	RG 180 B/U
			FC4104M	MC4104M	RG 58 B/U
		SOLDER / SOLDER	FS4101M	MS4101M	RG 178 B/U, 196 B/U
			FS4102M	MS4102M	RG 179 B/U, 316 B/U
			FS4103M	MS4103M	RG 180 B/U
			FS4104M	MS4104M	RG 58 B/U
		CRIMP / CRIMP	FCC4101M	MCC4101M	RG 178 B/U, 196 B/U
			FCC4102M	MCC4102M	RG 179 BU/, 316 B/U
			FCC4103M	MCC4103M	RG 180 B/U
			FCC4104M	MCC4104M	RG 58 B/U

**NOTE:** For ordering crimp contacts on reels, add "R" to part number, *see page 77 for details*. Examples: FC4008MR or MC4008MR

For information regarding **REMOVABLE CONTACTS**, see contact illustration drawings and charts on pages 77-85.

For information regarding **CRIMP TOOLS & CRIMPING TOOL TECHNIQUES**, see page 96.



**ORDERING INFORMATION - CODE NUMBERING SYSTEM**

Specify Complete Connector By Selecting An Option From Step 1 Through 8

**FOR CONNECTORS INCLUDING SIZE 8 CONTACTS**

STEP	1	2	3	4	5	6	7	8	9
EXAMPLE	SCBDD	19W1	M	47	R7	0	T2	G	—
<b>STEP 1 - BASIC SERIES</b> SCBDD Series									<b>STEP 9 - SPECIAL OPTIONS</b> <i>SEE APPENDIX ON PAGE 95.</i>
<b>STEP 2 - CONNECTOR VARIANTS</b> Shell Size 2 - 19W1 Shell Size 3 - 15W4 *1 Shell Size 4 - 45W2 <i>See page 54 for ordering information for shell size 1 - 8W2 options.</i>									<b>STEP 8 - CONNECTOR HOUSING (SHELLS) OPTION</b> G - Gold over copper plate. D - Gold over copper plate and dimpled (male connectors only).
<b>STEP 3 - CONNECTOR GENDER</b> M - Male S - Female - PosiBand closed entry contacts, <i>see page 1 for more information.</i>									<b>*2 STEP 7 - LOCKING AND POLARIZING SYSTEMS</b> 0 - None. T - Fixed female jackscrews. T2 - Fixed female jackscrews. T6 - Fixed male and female polarized jackscrews. E - Rotating male jackscrews. E2 - Rotating male screw locks. E3 - Rotating male with internal hex for 3/32 hex drives. E6 - Rotating male and female polarized jackscrews.
<b>STEP 4 - CONTACT TERMINATION TYPE</b> 21 - Fixed, solder cup, signal contact only. 3 - Solder, straight printed board mount with signal contacts only 0.170 [4.32] tail length. 35 - Solder, straight printed board mount with signal and 0.078 [1.98] Ø power contacts, 0.170 [4.32] tail length. 36 - Solder, straight printed board mount with signal and 0.094 [2.39] Ø power contacts, 0.170 [4.32] tail length. 37 - Solder, straight printed board mount with signal and 0.125 [3.18] Ø power contacts, 0.170 [4.32] tail length. 4 - Solder, right angle (90°) printed board mount with signal contacts only, 0.314 [7.98] signal contact extension. 45 - Solder, right angle (90°) printed board mount with signal and 0.078 [1.98] Ø power contacts, 0.314 [7.98] signal contact extension. 47 - Solder, right angle (90°) printed board mount with signal and 0.125 [3.18] Ø power contacts, 0.314 [7.98] signal contact extension. 65 - Solder, straight printed board mount with signal and shielded contacts MDS/FDS4201D footprint, 0.170 [4.32] signal contact tail length. 84 - Solder, right angle (90°) printed board mount with signal and shielded contacts MRT/FDS4201D footprint, 0.314 [7.98] signal contact extension.									<b>*2 STEP 6 - CABLE ADAPTER (HOOD) AND PUSH-ON FASTENER</b> 0 - None AN - Cable adapter, lightweight aluminum, electroless nickel plate, see page 91 for details. H - Cable adapter, top opening, brass N - Push-on fastener, for right angle (90°) mounting brackets
<b>NOTES</b> *1 45W2 variant currently available in male only. *2 For additional information of options listed in steps 5, 6, and 7, see Accessories Section on pages 86-94.									<b>*2 STEP 5 - MOUNTING STYLE</b> 0 - Mounting hole, 0.120 [3.05] Ø 02 - Mounting hole, 0.154 [3.91] Ø C5 - Swaged spacer, Cul-de-Sac style, 4-40 threads, 0.350 [8.89] length. For use with cable connectors only. C7 - Bracket, mounting, right angle (90°) metal, swaged to connector with Cul-de-Sac spacer and 4-40 threads with cross bar. F - Float mounts, universal P - Threaded post, brass, 0.250 [6.35] length R2 - Bracket, mounting, right angle (90°) metal, swaged to connector with 4-40 thread fixed female jackscrews with cross bar R6 - Bracket, mounting, right angle (90°) metal, swaged to connector with 0.120 [3.05] Ø mounting hole with cross bar R7 - Bracket, mounting, right angle (90°) metal, swaged to connector with 4-40 threads with cross bar R8 - Bracket, mounting, right angle (90°) metal, swaged to connector with 4-40 locknut with cross bar S - Swaged spacer, 4-40 threads, 0.250 [6.35] length S2 - Swaged spacer, 4-40 threads, 0.125 [3.18] length S5 - Swaged locknut, 4-40 threads S6 - Swaged spacer with push-on fastener, 4-40 threads, 0.250 [6.35] length

*Do you need 2-D drawings or 3-D models?*  
See page 18 for more information!



Positronic Industries  
connectpositronic.com



**SCBCD SERIES**  
**MILITARY / SPACE FLIGHT QUALITY**  
**HIGH DENSITY REMOVABLE CONTACTS**

**High**  
**Performance**  
**D-sub**



- ✓ High performance for use in harsh environments, including space flight.
- ✓ Size 22, Size 16 and Size 8 **removable** contacts.
- ✓ All female closed entry signal contacts utilize the "PosiBand®" system. *See page 1 for details.* GSFC S-311-P-4/08 offers two contact engagement test options. Size 22 PosiBand contacts meet the higher 40 gram requirements per 4.2.2.b.
- ✓ Three connector variants with a mixture of signal, power, shielded and high voltage contacts.
- ✓ Terminations include cable or wire crimp and solder.
- ✓ Current ratings to 70 amperes.  
*See temperature rise curves on page 3 & 4 for details.*
- ✓ A wide variety of options and accessories.

**Conforming To Applicable Material, Dimensional and Performance Requirements:**

- GSFC S-311-P4 & GSFC S-311-P10
- DSCC Specification 85039

**Conforming To Outgassing Requirements:**

- ASTM E-595 & NASA-RP-1124

**T E C H N I C A L C H A R A C T E R I S T I C S**

**MATERIALS AND FINISHES:**

<b>Connector Insert:</b>	Glass-filled polyester per ASTM-D-5927, UL 94V-0, ASTM E-595, NASA-RP-1124 blue color.
<b>Contacts:</b>	
<b>Size 22:</b>	Precision machined copper alloy. 0.000050 inch [1.27 microns] gold over copper plate. Other finishes are available; see page 95.
<b>Size 16:</b>	Precision machined high conductivity copper alloy. 0.000050 inch [1.27 microns] gold over copper plate. Other finishes are available; see page 95.
<b>Size 8:</b>	
<b>Power:</b>	Precision machined high conductivity copper alloy. 0.000050 inch [1.27 microns] gold over copper plate. Other finishes are available; see page 95.
<b>Shielded:</b>	<i>For material and finishes, see page 77.</i>
<b>High Voltage:</b>	<i>For material and finishes, see page 77.</i>
<b>Connector Housing (Shells):</b>	Brass with 0.000050 inch [1.27 microns] gold over copper plate.
<b>Mounting Spacers and Brackets:</b>	Brass with 0.000050 inch [1.27 microns] gold over copper plate.

**Jackscrew Systems:**

Brass with 0.000050 inch [1.27 microns] gold over copper plate.

**Cable Adapter (Hood):**

Brass with 0.000050 inch [1.27 microns] gold over copper plate; aluminum with electroless nickel plate. Other finishes available, contact Technical Sales.

**MECHANICAL CHARACTERISTICS:**

**Size 22 Removable:**

Male contact - 0.030 inch [0.76 mm] mating diameter. Female contact - PosiBand closed entry design; *see page 1 for details.* *For removable size 22 contacts, see page 79.*

**Size 16 Removable:**

Male - 0.062 inch [1.57mm] mating diameter. Female contact - PosiBand closed entry design; *see page 1 for details.* *For removable size 16 contacts, see page 81.*

**Size 8 Removable:**

Male contact - 0.142 inch [3.61 mm] mating diameter. Female contact - features Large Surface Area (L.S.A.) closed entry design utilizing BeCu mechanical retention member. Closed crimp barrel. *For removable size 8 contacts, see pages 81-85.*

*continued on next page. . .*





## TECHNICAL CHARACTERISTICS, *continued*

*continued from previous page. . .*

### MECHANICAL CHARACTERISTICS, continued:

<b>Shielded:</b>	For mechanical characteristics, see page 77.
<b>High Voltage:</b>	For mechanical characteristics, see page 77.
<b>Contact Retention in Connector Insert:</b>	
<b>Size 22:</b>	9 lbs. [40N] minimum.
<b>Size 16:</b>	15 lbs. [67N] minimum.
<b>Size 8 Power / Shielded:</b>	22 lbs. [98N].
<b>Contact Terminations:</b>	
<b>Size 22:</b>	Closed barrel crimp - wire sizes 20 AWG [0.5 mm <sup>2</sup> ] through 30 AWG [0.05 mm <sup>2</sup> ]. Closed barrel solder - wire size 22 AWG [0.3 mm <sup>2</sup> ] maximum; see page 79 for details.
<b>Size 16:</b>	Closed barrel crimp - wire sizes 12 AWG [4.0 mm <sup>2</sup> ] through 24 AWG [0.25 mm <sup>2</sup> ].
<b>Size 8:</b>	
<b>Power:</b>	Closed barrel crimp or solder cup - wire sizes 8 [10.0 mm <sup>2</sup> ], 10 [5.3 mm <sup>2</sup> ], 12 [4.0 mm <sup>2</sup> ], and 16 [1.5 mm <sup>2</sup> ] AWG.
<b>Shielded:</b>	Refer to RF Cable in chart on page 84 for contact terminations.
<b>High Voltage:</b>	Straight and right angle (90°) terminations - 0.041 inch [1.04 mm] minimum hole diameter.
<b>Connector Housing (Shells):</b>	Male connector housings may be dimpled for EMI/ESD ground paths.
<b>Polarization:</b>	Trapezoidally-shaped connector housings and polarized jackscrews.

<b>Locking Systems:</b>	Jackscrews.
<b>Mechanical Operations:</b>	1,000 operations per IEC 60512-5.

### ELECTRICAL CHARACTERISTICS:

#### SIZE 22 CONTACTS

<b>Contact Current Rating:</b>	5 amperes, nominal
<b>Initial Contact Resistance:</b>	0.005 ohms maximum.
<b>Proof Voltage:</b>	1000 V r.m.s.

#### SIZE 16 CONTACTS

<b>Contact Current Rating, Tested per UL 1977:</b>	28 amperes
<i>See temperature rise curves on page 4 for details.</i>	
<b>Initial Contact Resistance:</b>	0.0016 ohms maximum, per IEC 60512-2, Test 2b.
<b>Proof Voltage:</b>	1000 V r.m.s.

#### SIZE 8 CONTACTS

**POWER CONTACTS**  
*For electrical characteristics, see page 21.*

**SHIELDED CONTACTS**  
*For electrical characteristics, see page 77.*

**HIGH VOLTAGE CONTACTS**  
*For electrical characteristics, see page 77.*

#### CONNECTOR

<b>Insulation Resistance:</b>	5 G ohms.
<b>Clearance and Creepage Distance:</b>	0.042 inch [1.06 mm], minimum.
<b>Working Voltage:</b>	300 V r.m.s.

### CLIMATIC CHARACTERISTICS:

<b>Temperature Range:</b>	-55°C to +125°C.
<b>Damp Heat, Steady State:</b>	10 days.

Visit our website for the latest catalog updates and supplements at  
<http://www.connectpositronic.com/products/62/HighPerformanceD-subminiature/catalogs/>

### \*1 CONTACT VARIANT

FACE VIEW OF MALE OR REAR VIEW OF FEMALE

#### — SHELL SIZE 1 —

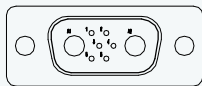

**8W2**

Six (6) Size 22 Signal Contacts and Two (2) Size 16 Power Contacts

#### — SHELL SIZE 2 —

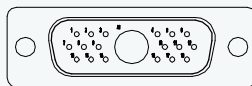

**19W1**

Eighteen (18) Size 22 Signal Contacts and One (1) Size 8 Power Contact

#### — SHELL SIZE 4 —

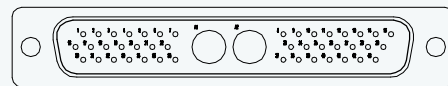

**\*2 45W2**

Forty-three (43) Size 22 Signal Contacts and Two (2) Size 8 Power Contacts

**OTHER VARIANTS WILL BE ADDED, CONSULT OUR WEBSITE OR CONTACT TECHNICAL SALES FOR UPDATED INFORMATION.**

#### NOTES:

- \*1 Additional contact variants may be tooled at customer request.
- \*2 45W2 variant currently available in female only. Contact Technical Sales for availability of male connector.



Positronic Industries  
connectpositronic.com



# SCBCD SERIES

MILITARY / SPACE FLIGHT QUALITY  
HIGH DENSITY REMOVABLE CONTACTS

High  
Performance  
D-sub

## STANDARD CONNECTOR HOUSING (SHELLS) ASSEMBLY



SCBCD45W2S0000G

SCBCD8W2S0000G

**RECOMMENDED MATING DIMENSIONS**

**NEW!**

Shell Sizes 1 & 2 =  
0.265±0.015 [6.73±0.38]  
Shell Sizes 3, 4, 5 & 6 =  
0.256±0.015 [6.50±0.38]

**TYPICAL CONNECTOR TOP VIEW**

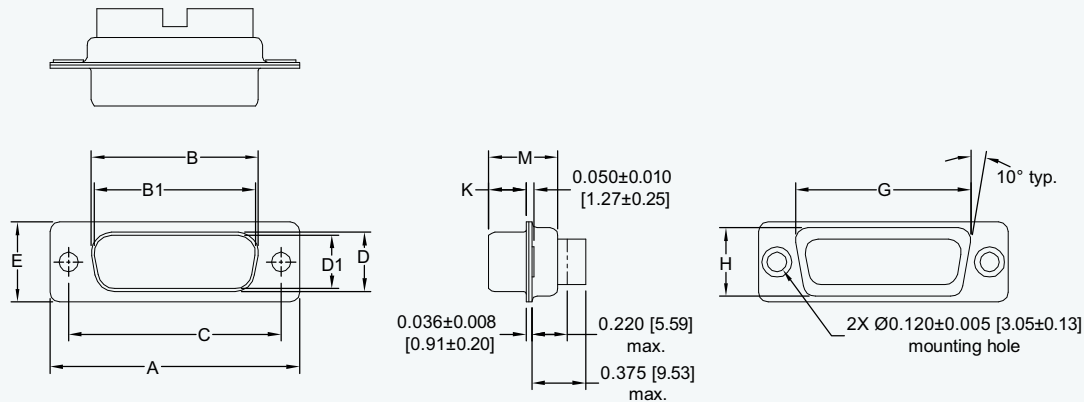

**OPTIONAL CONNECTOR HOUSING ASSEMBLY (0, 02)**

2X Ø120±0.005 [3.05±0.13] mounting hole for stainless steel shell (0 option).  
2X Ø0.154 [3.91] mounting hole (02 option).

**OPTIONAL CONNECTOR HOUSING ASSEMBLY WITH UNIVERSAL FLOAT MOUNTS (F)**

0.120±0.010 [3.05±0.25]  
0.032 [0.81] total diametral float  
2X Ø0.086±0.005-0.000 [2.18+0.13-0.00] mounting hole

SHELL SIZES	VARIANT	A ±0.015 [0.38]	B ±0.005 [0.13]	B1 ±0.005 [0.13]	C ±0.005 [0.13]	D ±0.005 [0.13]	D1 ±0.005 [0.13]	E ±0.015 [0.38]	G ±0.010 [0.25]	H ±0.010 [0.25]	K ±0.005 [0.13]	M ±0.010 [0.25]
1	8W2 M	1.213 [30.81]		0.666 [16.92]	0.984 [24.99]		0.329 [8.36]	0.494 [12.55]	0.759 [19.28]	0.422 [10.72]	0.233 [5.92]	0.422 [10.72]
	8W2 S	1.213 [30.81]	0.643 [16.33]		0.984 [24.99]	0.311 [7.90]		0.494 [12.55]	0.759 [19.28]	0.422 [10.72]	0.243 [6.17]	0.429 [10.90]
2	19W1 M	1.541 [39.14]		0.994 [25.25]	1.312 [33.32]		0.329 [8.36]	0.494 [12.55]	1.083 [27.51]	0.422 [10.72]	0.233 [5.92]	0.422 [10.72]
	19W1 S	1.541 [39.14]	0.971 [24.66]		1.312 [33.32]	0.311 [7.90]		0.494 [12.55]	1.083 [27.51]	0.422 [10.72]	0.243 [6.17]	0.429 [10.90]
4	45W2 S	2.729 [69.32]	2.159 [54.84]		2.500 [63.50]	0.311 [7.90]		0.494 [12.55]	2.272 [57.71]	0.422 [10.72]	0.243 [6.17]	0.429 [10.90]



## REMOVABLE CONTACT ORDERING ASSISTANCE CHART



### SCBCD SERIES CRIMP AND SOLDER TERMINATION CONTACTS

TYPE	PAGE NUMBER REFERENCE IN CATALOG	CONTACT SIZE	FEMALE PART NUMBER	MALE PART NUMBER	WIRE SIZE AWG [mm <sup>2</sup> ]
CRIMP	see page 78 for additional information	22	FC8022M2	MC8022M	22 [0.3] / 24 [0.25] / 26 [0.12] / 28 [0.08] / 30 [0.5]
			FC8020M2	MC8020M	20 [0.5] max.
	see page 81 for additional information	16	FC112N4-50	MC112N-50-133.0	12 [4.0]
			FC114N4-50	MC114N-50-133.0	14 [2.5] / 16 [1.5]
			FC116N4-50	MC116N-50-133.0	16 [1.5] / 18 [1.0]
			FC120N4-50	MC120N-50-133.0	20 [0.5] / 22 [0.3] / 24 [0.25]
	see page 81 for additional information	8	FC4008M	MC4008M	8 [10.0]
			FC4010M	MC4010M	10 [5.3]
			FC4012M	MC4012M	12 [4.0]
			FC4016M	MC4016M	16 [1.5]
SOLDER	see page 79 for additional information	22	FS8022M2	MS8022M	22 [0.3] max.
SOLDER CUP	see page 82 for additional information	8	FS4008M	MS4008M	8 [10.0]
			FS4012M	MS4012M	12 [4.0]
			FS4016M	MS4016M	16 [1.5]
HIGH VOLTAGE <i>Straight Solder Wire</i>	see page 83 for additional information	8	FS4820M	MS4820M	20 [0.5]
HIGH VOLTAGE <i>Right Angle (90°) Solder Wire</i>		8	FS4920M	MS4920M	20 [0.5]
SHIELDED	see page 84 for additional information	SOLDER / CRIMP	FC4101M	MC4101M	RG 178 B/U, 196 B/U
			FC4102M	MC4102M	RG 179 BU/, 316 B/U
			FC4103M	MC4103M	RG 180 B/U
			FC4104M	MC4104M	RG 58 B/U
		SOLDER / SOLDER	FS4101M	MS4101M	RG 178 B/U, 196 B/U
			FS4102M	MS4102M	RG 179 B/U, 316 B/U
			FS4103M	MS4103M	RG 180 B/U
			FS4104M	MS4104M	RG 58 B/U
		CRIMP / CRIMP	FCC4101M	MCC4101M	RG 178 B/U, 196 B/U
			FCC4102M	MCC4102M	RG 179 BU/, 316 B/U
			FCC4103M	MCC4103M	RG 180 B/U
			FCC4104M	MCC4104M	RG 58 B/U

**NOTE:** For ordering crimp contacts on reels, add "R" to part number, see page 77 for details. Examples: FC4008MR or MC4008MR

For information regarding REMOVABLE CONTACTS, see contact illustration drawings and charts on pages 77-85.

For information regarding CRIMP TOOLS & CRIMPING TOOL TECHNIQUES, see page 96.



Positronic Industries  
connectpositronic.com



**SCBCD SERIES**  
MILITARY / SPACE FLIGHT QUALITY  
HIGH DENSITY REMOVABLE CONTACTS

High  
Performance  
D-sub

**ORDERING INFORMATION - CODE NUMBERING SYSTEM**

Specify Complete Connector By Selecting An Option From Step 1 Through 8

STEP	1	2	3	4	5	6	7	8	9
EXAMPLE	SCBCD	8W2	S	0	0	0	0	G	—

**STEP 1 - BASIC SERIES**

SCBCD Series

**STEP 2 - CONNECTOR VARIANTS**

Shell Size 1 - 8W2

Shell Size 2 - 19W1

\*1 Shell Size 4 - 45W2

**STEP 3 - CONNECTOR GENDER**

M - Male

S - Female - PosiBand closed entry contacts,  
see page 1 for more information.

**STEP 4 - CONTACT TERMINATION TYPE**

0 - Contacts ordered separately, see contact chart on page 60 for details.

1 - Signal contacts, 22 AWG-30 AWG [0.03mm<sup>2</sup>-0.05mm<sup>2</sup>].

\*2 11 - Signal contacts, 22 AWG-30 AWG [0.03mm<sup>2</sup>-0.05mm<sup>2</sup>] with MC/FC 4012M power contact.

\*2 12 - Signal contacts, 22 AWG-30 AWG [0.03mm<sup>2</sup>-0.05mm<sup>2</sup>] with MC/FC 4016M power contact.

\*2 13 - Signal contacts, 22 AWG-30 AWG [0.03mm<sup>2</sup>-0.05mm<sup>2</sup>] with MCC/FCC 4101M shielded contacts.

\*2 14 - Signal contacts, 22 AWG-30 AWG [0.03mm<sup>2</sup>-0.05mm<sup>2</sup>] with MCC/FCC 4102M shielded contacts.

**\*3 STEP 5 - MOUNTING STYLE**

0 - Mounting hole, 0.120 [3.05] Ø

02 - Mounting hole, 0.154 [3.91] Ø

C5 - Swaged spacer, Cul-de-Sac style, 4-40 threads, 0.350 [8.89] length.

F - Float mounts, universal

S2 - Swaged spacer, 4-40 threads, 0.125 [3.18] length

S5 - Swaged locknut, 4-40 threads

**STEP 9 - SPECIAL OPTIONS**

SEE APPENDIX ON PAGE 95.

**STEP 8 - CONNECTOR HOUSING (SHELLS) OPTION**

G - Gold over copper plate.

D - Gold over copper plate and dimpled (male connectors only).

**\*3 STEP 7 - LOCKING AND POLARIZING SYSTEMS**

0 - None.

T - Fixed female jackscrews.

T2 - Fixed female jackscrews.

T6 - Fixed male and female polarized jackscrews.

E - Rotating male jackscrews.

E2 - Rotating male screw locks.

E3 - Rotating male with internal hex for 3/32 hex drives

E6 - Rotating male and female polarized jackscrews.

**\*3 STEP 6 - CABLE ADAPTER (HOOD) AND PUSH-ON FASTENER**

0 - None

AN - Cable adapter, lightweight aluminum, electroless nickel plate, see page 91 for details.

H - Cable adapter, top opening, brass

N - Push-on fastener, for right angle (90°) mounting brackets

**NOTES**

\*1 45W2 variant currently available in female only.

\*2 Available on 19W1 and 45W2 connectors only.







\*3 For additional information of options listed in steps 5, 6, and 7, see Accessories Section on pages 86-94.

*Do you need 2-D drawings or 3-D models?*

See page 18 for more information!

*For information regarding CRIMP TOOLS & CRIMPING TOOL TECHNIQUES, see page 96.*



-  High performance for use in harsh environments, including space flight.
-  Size 20 **fixed** contacts.
-  Female closed entry contacts utilize the “PosiBand®” system.  
*See page 1 for details.*
-  Five connector variants include 9, 15, 25, 37, and 50 contacts.
-  Suitable for use as connector saver or gender changer.
-  A wide variety of jackscrew options allows for mechanical keying.

**Conforming To Applicable Material, Dimensional and Performance Requirements:**

- GSFC S-311-P4 & GSFC S-311-P10
- MIL-DTL-24308 Class M

**Conforming To Outgassing Requirements:**

- ASTM E-595 & NASA-RP-1124

## TECHNICAL CHARACTERISTICS

### MATERIALS AND FINISHES:

**Connector Insulator:** Glass-filled DAP per ASTM-D-5948, UL 94V-0, ASTM E-595, NASA-RP-1124.

**Contacts:** Precision machined copper alloy. 0.000050 inch [1.27 microns] gold over copper plate. Other finishes are available; see page 95.

**Connector Housing (Shells), Spacers and Jackscrew Systems:** Brass with 0.000050 inch [1.27 microns] gold over copper plate.

### MECHANICAL CHARACTERISTICS:

**Size 20 Fixed:** Male contact - 0.040 inch [1.02 mm] mating diameter. Female contact - PosiBand closed entry design; *see page 1 for details.*

**Connector Saver:** Male to female, or male to male.

**Contact Retention:** 9 lbs. [40 N].

**Connector Housing (Shells):** Male connector housings may be dimpled for EMI/ESD ground paths.

**Polarization:** Trapezoidally-shaped connector housings.

**Mechanical Operations:** 1,000 operations, minimum, per IEC 60512-5.

### ELECTRICAL CHARACTERISTICS:

**Contact Current Rating:** 7.5 amperes, nominal.

**Initial Contact Resistance:** 0.008 ohms, maximum.

**Proof Voltage:** 1,000 V r.m.s.

**Insulator Resistance:** 5 G ohms.

**Clearance and Creepage Distance:** 0.039 inch [1.0 mm], minimum.

**Working Voltage:** 300 V r.m.s.

### CLIMATIC CHARACTERISTICS:

**Temperature Range:** -55°C to +125°C.

Visit our website for the latest catalog updates and supplements at  
<http://www.connectpositronic.com/products/62/HighPerformanceD-subminiature/catalogs/>



Positronic Industries  
connectpositronic.com

# SAD SERIES

## MILITARY / SPACE FLIGHT QUALITY

### STANDARD DENSITY CONNECTOR SAVER

High  
Performance  
D-sub

## SAD SERIES SIZE 20 CONTACT CONNECTOR SAVER

### CONTACT VARIANTS

FACE VIEW OF MALE OR REAR VIEW OF FEMALE

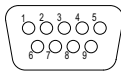

SAD 9

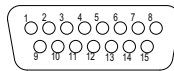

SAD 15

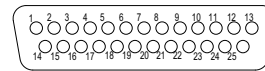

SAD 25

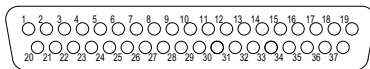

SAD 37

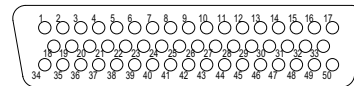

SAD 50

## STANDARD CONNECTOR HOUSING (SHELLS) ASSEMBLY DIMENSIONS

### SIZE 20 CONTACTS

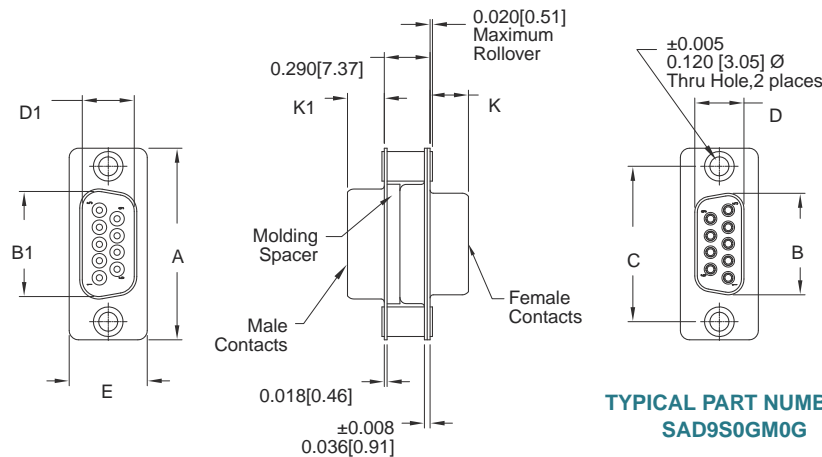

TYPICAL PART NUMBER:  
SAD9S0GM0G

CONNECTOR VARIANT SIZES	A ±0.015 [0.38]	B ±0.005 [0.13]	B1 ±0.005 [0.13]	C ±0.005 [0.13]	D ±0.005 [0.13]	D1 ±0.005 [0.13]	E ±0.015 [0.38]	K ±0.005 [0.13]	K1 ±0.005 [0.13]
9 M	1.213 [30.81]		0.666 [16.92]	0.984 [24.99]		0.329 [8.36]	0.494 [12.55]		0.233 [5.92]
9 S	1.213 [30.81]	0.643 [16.33]		0.984 [24.99]	0.311 [7.90]		0.494 [12.55]	0.243 [6.17]	
15 M	1.541 [39.14]		0.994 [25.25]	1.312 [33.32]		0.329 [8.36]	0.494 [12.55]		0.233 [5.92]
15 S	1.541 [39.14]	0.971 [24.66]		1.312 [33.32]	0.311 [7.90]		0.494 [12.55]	0.243 [6.17]	
25 M	2.088 [53.04]		1.534 [38.96]	1.852 [47.04]		0.329 [8.36]	0.494 [12.55]		0.230 [5.84]
25 S	2.088 [53.04]	1.511 [38.38]		1.852 [47.04]	0.311 [7.90]		0.494 [12.55]	0.243 [6.17]	
37 M	2.729 [69.32]		2.182 [55.42]	2.500 [63.50]		0.329 [8.36]	0.494 [12.55]		0.230 [5.84]
37 S	2.729 [69.32]	2.159 [54.84]		2.500 [63.50]	0.311 [7.90]		0.494 [12.55]	0.243 [6.17]	
50 M	2.635 [66.93]		2.079 [52.81]	2.406 [61.11]		0.441 [11.20]	0.605 [15.37]		
50 S	2.635 [66.93]	2.064 [52.43]		2.406 [61.11]	0.423 [10.74]		0.605 [15.37]	0.243 [6.17]	



**JACKSCREW SYSTEMS**

CODE E, E6, T AND T6

ROTATING  
MALE AND FEMALE  
JACKSCREWS

**E**

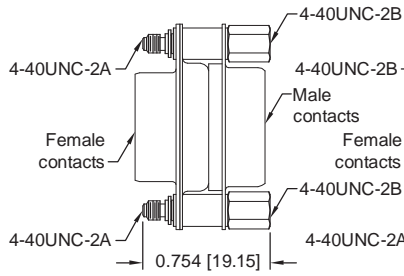

EXAMPLE PART NUMBER:  
SAD9SEGM0G

ROTATING  
MALE AND FEMALE  
POLARIZED  
JACKSCREWS

**E6**

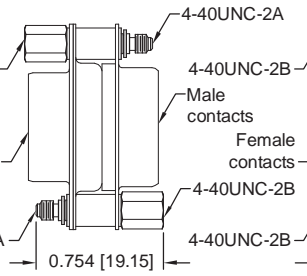

EXAMPLE PART NUMBER:  
SAD9SE6GM0G

FIXED  
MALE AND FEMALE  
JACKSCREWS

**T**

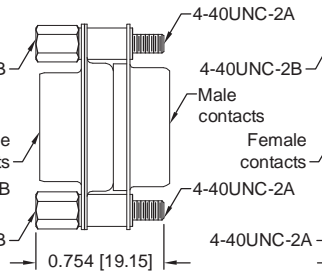

EXAMPLE PART NUMBER:  
SAD9STGM0G

FIXED  
MALE AND FEMALE  
POLARIZED  
JACKSCREWS

**T6**

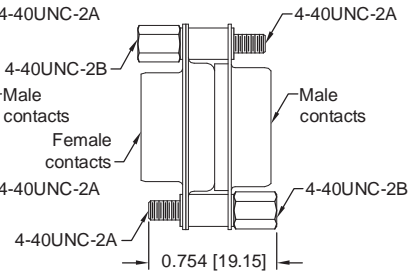

EXAMPLE PART NUMBER:  
SAD9ST6GM0G



SAD15S0GM0G connector saver mated to  
SND15S5R70T2G connector.



Positronic Industries  
connectpositronic.com

# SAD SERIES

## MILITARY / SPACE FLIGHT QUALITY

### STANDARD DENSITY CONNECTOR SAVER

High  
Performance  
D-sub



## ORDERING INFORMATION - CODE NUMBERING SYSTEM

Specify Complete Connector By Selecting An Option From Step 1 Through 8

STEP	1	2	3	4	5	6	7	8	9
EXAMPLE	SAD	9	S	S	G	M	S	D	—

### STEP 1 - BASIC SERIES

SAD series

### STEP 2 - CONNECTOR VARIANT

9, 15, 25, 37, 50

### STEP 3 - 1<sup>ST</sup> CONNECTOR GENDER

M - Male  
S - Female - PosiBand closed entry contacts,  
*see page 1 for more information.*

### \*1 STEP 4 - 1<sup>ST</sup> CONNECTOR MATING STYLE

- 0 - Swaged spacer 0.120 [3.05µ] mounting hole
- S - Swaged spacer 4-40 UNC-2B threads
- \*2 E - Rotating male and female jackscrews  
*(Select 0 in Step 7)*
- \*2 E6 - Rotating male and female polarized jackscrew  
*(Select 0 in Step 7)*
- \*2 T - Fixed male and female jackscrews  
*(Select 0 in Step 7)*
- \*2 T6 - Fixed male and female polarized jackscrew  
*(Select 0 in Step 7)*

### STEP 5 - 1<sup>ST</sup> CONNECTOR HOUSING (SHELLS) OPTION

G - Gold over copper plate.  
D - Gold over copper plate and dimpled  
*(male connectors only).*

### STEP 9 - SPECIAL OPTIONS

SEE APPENDIX ON PAGE 95.

### STEP 8 - 2<sup>ND</sup> CONNECTOR HOUSING (SHELLS) OPTION

G - Gold over copper plate.  
D - Gold over copper plate and dimpled  
*(male connectors only).*

### \*1 STEP 7 - 2<sup>ND</sup> CONNECTOR MATING STYLE

- 0 - Swaged spacer 0.120 [3.05µ] mounting hole
- S - Swaged spacer 4-40 UNC-2B threads
- \*2 E - Rotating male and female jackscrews  
*(Select 0 in Step 4)*
- \*2 E6 - Rotating male and female polarized jackscrew  
*(Select 0 in Step 4)*
- \*2 T - Fixed male and female jackscrews  
*(Select 0 in Step 4)*
- \*2 T6 - Fixed male and female polarized jackscrew  
*(Select 0 in Step 4)*

### STEP 6 - 2<sup>ND</sup> CONNECTOR GENDER

M - Male

### NOTES

\*1 Connector mating style for both connectors must be the same if 0 or S is used. If E or E6 is used in either Step 4 or 8 the other step must be 0.

\*2 For hardware information, see page 64.

*Do you need 2-D drawings or 3-D models?*

See page 18 for more information!



High  
Performance  
D-sub

# SADD SERIES

MILITARY / SPACE FLIGHT QUALITY  
HIGH DENSITY CONNECTOR SAVER



Positronic Industries  
connectpositronic.com



- ✓ High performance for use in harsh environments, including space flight.
- ✓ Size 22 **fixed** contacts.
- ✓ Female closed entry contacts utilize the "PosiBand®" system. *See page 1 for details.*
- ✓ Five connector variants include 15, 26, 44, 62, 78, and 104 contacts.
- ✓ Suitable for use as connector saver or gender changer.
- ✓ A wide variety of jackscrew options allows for mechanical keying.

### Conforming To Applicable Material, Dimensional and Performance Requirements:

- GSFC S-311-P4
- MIL-DTL-24308 Class M

### Conforming To Outgassing Requirements:

- ASTM E-595 & NASA-RP-1124

SADD SERIES

## TECHNICAL CHARACTERISTICS

### MATERIALS AND FINISHES:

<b>Connector Insulator:</b>	Polyester glass-filled per ASTM-D-5927, UL 94V-0, ASTM E-595, NASA-RP-1124.
<b>Contacts:</b>	Precision machined copper alloy. 0.000050 inch [1.27 microns] gold over copper plate. Other finishes are available; see page 95.
<b>Connector Housing (Shells), Spacers and Jackscrew Systems:</b>	Brass with 0.000050 inch [1.27 microns] gold over copper plate.

### MECHANICAL CHARACTERISTICS:

<b>Size 20 Fixed:</b>	Male contact - 0.030 inch [0.76 mm] mating diameter. Female contact - PosiBand closed entry design; <i>see page 1 for details.</i>
<b>Connector Saver:</b>	Male to female (or male to male, Size 78 only).
<b>Contact Retention:</b>	9 lbs. [40 N].

### Connector Housing (Shells):

Male connector housings may be dimpled for EMI/ESD ground paths.

### Polarization:

Trapezoidally-shaped connector housings.

### Mechanical Operations:

1,000 operations, minimum, per IEC 60512-5.

### ELECTRICAL CHARACTERISTICS:

<b>Contact Current Rating:</b>	5 amperes, nominal.
<b>Initial Contact Resistance:</b>	0.008 ohms, maximum.
<b>Proof Voltage:</b>	1,000 V r.m.s.
<b>Insulator Resistance:</b>	5 G ohms.
<b>Clearance and Creepage Distance:</b>	0.039 inch [1.0 mm], minimum.
<b>Working Voltage:</b>	300 V r.m.s.

### CLIMATIC CHARACTERISTICS:

<b>Temperature Range:</b>	-55°C to +125°C.
---------------------------	------------------

Visit our website for the latest catalog updates and supplements at  
<http://www.connectpositronic.com/products/62/HighPerformanceD-subminiature/catalogs/>



Positronic Industries  
connectpositronic.com

# SADD SERIES

## MILITARY / SPACE FLIGHT QUALITY

### HIGH DENSITY CONNECTOR SAVER

High  
Performance  
D-sub

## SADD SERIES SIZE 22 CONTACT CONNECTOR SAVER

### CONTACT VARIANTS

FACE VIEW OF MALE OR USE MIRROR IMAGE FOR FEMALE

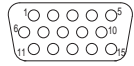

SADD 15

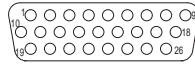

SADD 26

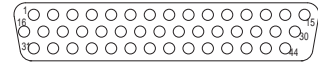

SADD 44

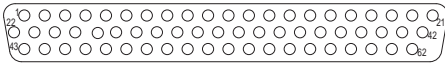

SADD 62

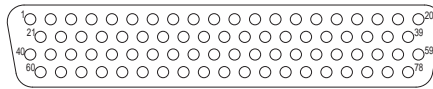

SADD 78

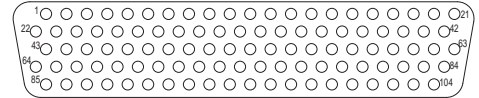

SADD 104

## STANDARD CONNECTOR HOUSING (SHELLS) ASSEMBLY DIMENSIONS

### SIZE 22 CONTACTS

TYPICAL PART NUMBER:  
SADD15S0G15M0G

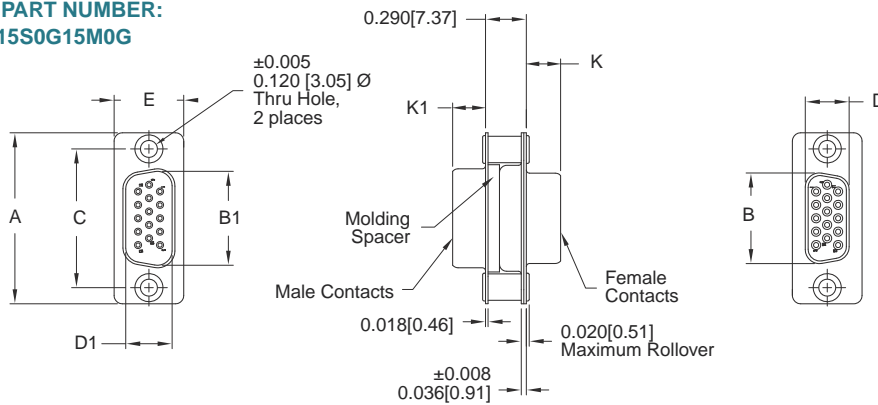

CONNECTOR VARIANT SIZES	A ±0.015 [0.38]	B ±0.005 [0.13]	B1 ±0.005 [0.13]	C ±0.005 [0.13]	D ±0.005 [0.13]	D1 ±0.005 [0.13]	E ±0.015 [0.38]	K ±0.005 [0.13]	K1 ±0.005 [0.13]
15 M	1.213 [30.81]		0.666 [16.92]	0.984 [24.99]		0.329 [8.36]	0.494 [12.55]		0.233 [5.92]
15 S	1.213 [30.81]	0.643 [16.33]		0.984 [24.99]	0.311 [7.90]		0.494 [12.55]	0.243 [6.17]	
26 M	1.541 [39.14]		0.994 [25.25]	1.312 [33.32]		0.329 [8.36]	0.494 [12.55]		0.233 [5.92]
26 S	1.541 [39.14]	0.971 [24.66]		1.312 [33.32]	0.311 [7.90]		0.494 [12.55]	0.243 [6.17]	
44 M	2.088 [53.04]		1.534 [38.96]	1.852 [47.04]		0.329 [8.36]	0.494 [12.55]		0.230 [5.84]
44 S	2.088 [53.04]	1.511 [38.38]		1.852 [47.04]	0.311 [7.90]		0.494 [12.55]	0.243 [6.17]	
62 M	2.729 [69.32]		2.182 [55.42]	2.500 [63.50]		0.329 [8.36]	0.494 [12.55]		0.230 [5.84]
62 S	2.729 [69.32]	2.159 [54.84]		2.500 [63.50]	0.311 [7.90]		0.494 [12.55]	0.243 [6.17]	
78 M	2.635 [66.93]		2.079 [52.81]	2.406 [61.11]		0.441 [11.20]	0.605 [15.37]		
78 S	2.635 [66.93]	2.064 [52.43]		2.406 [61.11]	0.423 [10.74]		0.605 [15.37]	0.243 [6.17]	
104 M	2.729 [69.32]		2.212 [56.18]	2.500 [63.50]		0.503 [12.78]	0.668 [16.97]		0.230 [5.84]
104 S	2.729 [69.32]	2.189 [55.60]		2.500 [63.50]	0.485 [12.32]		0.668 [16.97]	0.243 [6.17]	



## ORDERING INFORMATION - CODE NUMBERING SYSTEM

Specify Complete Connector By Selecting An Option From Step 1 Through 8

STEP	1	2	3	4	5	6	7	8	9
EXAMPLE	SADD	15	S	S	G	M	S	D	
<b>STEP 1 - BASIC SERIES</b> SADD series									<b>STEP 9 - SPECIAL OPTIONS</b> <i>SEE APPENDIX ON PAGE 95.</i>
<b>STEP 2 - CONNECTOR VARIANT</b> 15, 26, 44, 62, 78, 104									
<b>STEP 3 - 1<sup>ST</sup> CONNECTOR GENDER</b> <sup>*3</sup> M - Male S - Female - PosiBand closed entry contacts, <i>see page 1 for more information.</i>									
<b>*1 STEP 4 - 1<sup>ST</sup> CONNECTOR MATING STYLE</b> 0 - Swaged spacer 0.120 [3.05µ] mounting hole S - Swaged spacer 4-40 UNC-2B threads <sup>*2</sup> E - Rotating male and female jackscrews <i>(Select 0 in Step 7)</i> <sup>*2</sup> E6 - Rotating male and female polarized jackscrew <i>(Select 0 in Step 7)</i> <sup>*2</sup> T - Fixed male and female jackscrews <i>(Select 0 in Step 7)</i> <sup>*2</sup> T6 - Fixed male and female polarized jackscrew <i>(Select 0 in Step 7)</i>									
<b>STEP 5 - 1<sup>ST</sup> CONNECTOR HOUSING (SHELLS) OPTION</b> G - Gold over copper plate. D - Gold over copper plate and dimpled <i>(male connectors only).</i>									
									<b>STEP 8 - 2<sup>ND</sup> CONNECTOR HOUSING (SHELLS) OPTION</b> G - Gold over copper plate. D - Gold over copper plate and dimpled <i>(male connectors only).</i>
									<b>*1 STEP 8 - 2<sup>ND</sup> CONNECTOR MATING STYLE</b> 0 - Swaged spacer 0.120 [3.05µ] mounting hole S - Swaged spacer 4-40 UNC-2B threads <sup>*2</sup> E - Rotating male and female jackscrews <i>(Select 0 in Step 4)</i> <sup>*2</sup> E6 - Rotating male and female polarized jackscrew <i>(Select 0 in Step 4)</i> <sup>*2</sup> T - Fixed male and female jackscrews <i>(Select 0 in Step 4)</i> <sup>*2</sup> T6 - Fixed male and female polarized jackscrew <i>(Select 0 in Step 4)</i>
									<b>STEP 6 - 2<sup>ND</sup> CONNECTOR GENDER</b> M - Male

**NOTES**

- <sup>\*1</sup> Connector mating style for both connectors must be the same if 0 or S is used. If E or E6 is used in either Step 4 or 8 the other step must be 0.
- <sup>\*2</sup> For hardware information, see page 64.
- <sup>\*3</sup> Male option available only on connector variant 78.

*Do you need 2-D drawings or 3-D models?*  
See page 18 for more information!

**SADD SERIES**



Positronic Industries  
connectpositronic.com

# SACBMP SERIES

## MILITARY / SPACE FLIGHT QUALITY

### STANDARD DENSITY COMBO-D CONNECTOR SAVER

High  
Performance  
D-sub



- ✓ High performance for use in harsh environments, including space flight.
- ✓ Size 20 and Size 8 **fixed** contacts.
- ✓ All female closed entry signal contacts utilize the “PosiBand®” system. *See page 1 for details.*
- ✓ Twenty-two connector variants with a mixture of signal, power, shielded and high voltage contacts.
- ✓ Suitable for use as connector saver or gender changer.
- ✓ Current ratings: signal level to 7.5 amperes. *See temperature rise curves on page 2 for details.*
- ✓ A wide variety of jackscrew options allows for mechanical keying.

#### Conforming To Applicable Material, Dimensional and Performance Requirements:

- GSFC S-311-P4 & GSFC S-311-P10
- DSCC Specification 85039

#### Conforming To Outgassing Requirements:

- ASTM E-595 & NASA-RP-1124

## TECHNICAL CHARACTERISTICS

### MATERIALS AND FINISHES:

<b>Connector Insulator:</b>	Glass-filled polyester per ASTM-D-5927, UL 94-V0, ASTM E-595, NASA-RP-1124, blue color.
<b>Contacts:</b>	
<b>Size 20:</b>	Precision machined copper alloy. 0.000050 inch [1.27 microns] gold over copper plate. Other finishes are available; see page 95.
<b>Size 8:</b>	Precision machined high conductivity copper alloy. 0.000050 inch [1.27 microns] gold over copper plate. Other finishes are available; see page 95.
<b>Connector Housing (Shells), Spacers and Jackscrew Systems:</b>	Brass with 0.000050 inch [1.27 microns] gold over copper plate.

### MECHANICAL CHARACTERISTICS:

<b>Size 20 Fixed:</b>	Male contact - 0.040 inch [1.02 mm] mating diameter. Female contact - PosiBand closed entry design; <i>see page 1 for details.</i>
<b>Size 8 Fixed:</b>	Male - 0.142 inch [3.61mm] mating diameter. Female contact features Large Surface Area (L.S.A.) closed entry contact design utilizing BeCu mechanical retention member. Closed crimp barrel.
<b>Connector Saver:</b>	Male to female, male to male see page 72 for available variants.
<b>Contact Retention:</b>	9 lbs. [40 N].
<b>Connector Housing (Shells):</b>	Male connector housings may be dimpled for EMI/ESD ground paths.
<b>Polarization:</b>	Trapezoidally-shaped connector housings.
<b>Mechanical Operations:</b>	1,000 operations, minimum, per IEC 60512-5.

... continued on next page



## TECHNICAL CHARACTERISTICS, *continued*

continued from previous page. . .

### ELECTRICAL CHARACTERISTICS:

#### SIZE 20 CONTACTS

<b>Contact Current Rating:</b>	7.5 amperes, nominal
<b>Initial Contact Resistance:</b>	0.008 ohms maximum.
<b>Proof Voltage:</b>	1000 V r.m.s.

#### SIZE 8 CONTACTS

<b>Contact Current Rating:</b>	40 amperes, nominal
<b>Initial Contact Resistance:</b>	0.008 ohms maximum.
<b>Proof Voltage:</b>	1000 V r.m.s.

### CONNECTOR

<b>Insulation Resistance:</b>	5 G ohms.
<b>Clearance and Creepage Distance:</b>	0.039 inch [1.0 mm], minimum.
<b>Working Voltage:</b>	300 V r.m.s.

### CLIMATIC CHARACTERISTICS:

<b>Temperature Range:</b>	-55°C to +125°C.
---------------------------	------------------

Visit our website for the latest catalog updates and supplements at  
<http://www.connectpositronic.com/products/62/HighPerformanceD-subminiature/catalogs/>

## SACBMP SERIES SIZE 20 AND SIZE 8 CONTACT CONNECTOR SAVER

### CONTACT VARIANTS

FACE VIEW OF MALE OR REAR VIEW OF FEMALE

#### SHELL SIZE 1



#### SHELL SIZE 2

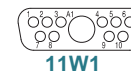
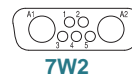
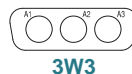

#### SHELL SIZE 3

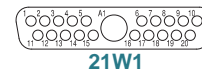
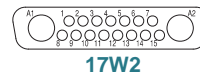
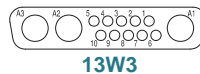
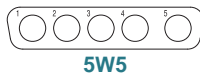

#### SHELL SIZE 4

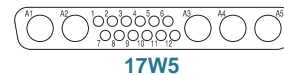
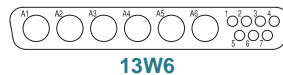
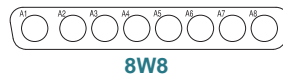

#### SHELL SIZE 5

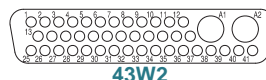
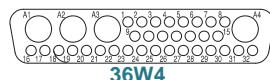
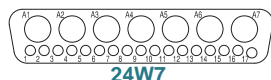

#### SHELL SIZE 6

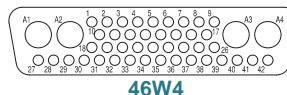

Note: For high density 8W2, 19W1, 15W4 and 45W2 variants contact Technical Sales for availability.



Positronic Industries  
connectpositronic.com

# SACBMP SERIES

## MILITARY / SPACE FLIGHT QUALITY

### STANDARD DENSITY COMBO-D CONNECTOR SAVER

High  
Performance  
D-sub

### STANDARD CONNECTOR HOUSING (SHELLS) ASSEMBLY DIMENSIONS SIZE 20 AND SIZE 8 CONTACTS

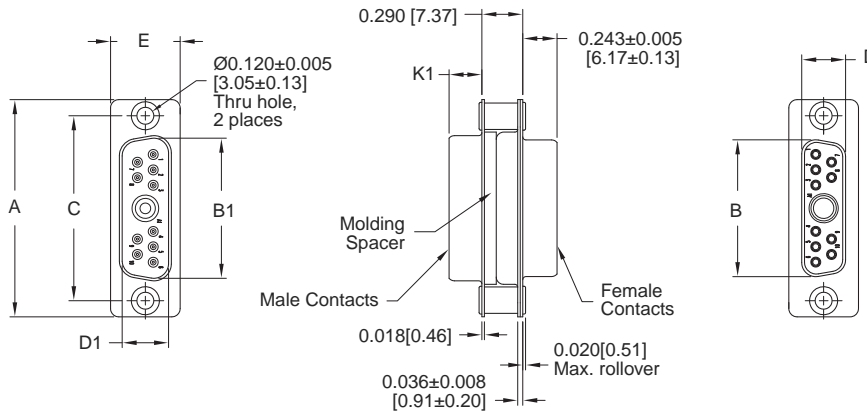

**NOTE:**  
Code S = Swaged  
spacer with 4-40  
UNC-2B threads.

**TYPICAL PART NUMBER:**  
**SACBMP11W1S0GM0G**

SHELL SIZES	CONNECTOR VARIANT	A $\pm 0.015$ [0.38]	B $\pm 0.005$ [0.13]	B1 $\pm 0.005$ [0.13]	C $\pm 0.005$ [0.13]	D $\pm 0.005$ [0.13]	D1 $\pm 0.005$ [0.13]	E $\pm 0.015$ [0.38]	K1 $\pm 0.005$ [0.13]
1	5W1	1.213 [30.81]	0.643 [16.33]	0.666 [16.92]	0.984 [24.99]	0.311 [7.90]	0.329 [8.36]	0.494 [12.55]	0.233 [5.92]
2	3W3, 7W2, 11W1	1.541 [39.14]	0.971 [24.66]	0.994 [25.25]	1.312 [33.32]	0.311 [7.90]	0.329 [8.36]	0.494 [12.55]	0.233 [5.92]
3	5W5, 9W4, 13W3, 17W2, 21W1	2.088 [53.04]	1.511 [38.38]	1.534 [38.96]	1.852 [47.04]	0.311 [7.90]	0.329 [8.36]	0.494 [12.55]	0.230 [5.84]
4	8W8, 13W6, 17W5, 21WA4, 25W3, 27W2	2.729 [69.32]	2.159 [54.84]	2.182 [55.42]	2.500 [63.50]	0.311 [7.90]	0.329 [8.36]	0.494 [12.55]	0.230 [5.84]
5	24W7, 36W4, 43W2, 47W1	2.635 [66.93]	2.064 [52.43]	2.079 [52.81]	2.406 [61.11]	0.423 [10.74]	0.441 [11.20]	0.605 [15.37]	0.230 [5.84]
6	46W4	2.729 [69.32]	2.189 [55.60]	2.212 [56.18]	2.500 [63.50]	0.485 [12.32]	0.503 [12.78]	0.668 [16.97]	0.230 [5.84]

SACBMP SERIES



## ORDERING INFORMATION - CODE NUMBERING SYSTEM

Specify Complete Connector By Selecting An Option From Step 1 Through 8

STEP	1	2	3	4	5	6	7	8	9
EXAMPLE	SACBMP	11W1	S	S	G	M	S	D	—
<b>STEP 1 - BASIC SERIES</b> SACBMP series									<b>STEP 9 - SPECIAL OPTIONS</b>  SEE APPENDIX ON PAGE 95.
<b>STEP 2 - CONNECTOR VARIANT</b> Shell Size 1 5W1 Shell Size 2 3W3, 7W2, 11W1 Shell Size 3 5W5, 9W4, 13W3, 17W2, 21W1 Shell Size 4 8W8, 13W6, 17W5, 21WA4, 25W3, 27W2 Shell Size 5 24W7, 36W4, 43W2, 47W1 Shell Size 6 46W4  <b>Note:</b> For high density 8W2, 19W1, 15W4 and 45W2 variants contact Technical Sales for availability.									<b>STEP 8 - 2<sup>ND</sup> CONNECTOR HOUSING (SHELLS) OPTION</b>  G - Gold over copper plate. D - Gold over copper plate and dimpled (male connectors only).  <b>*2 STEP 8 - 2<sup>ND</sup> CONNECTOR MATING STYLE</b> 0 - Swaged spacer 0.120 [3.05μ] mounting hole S - Swaged spacer 4-40 UNC-2B threads <b>*3 E</b> - Rotating male and female jackscrews (Select 0 in Step 4) <b>*3 E6</b> - Rotating male and female polarized jackscrew (Select 0 in Step 4) <b>*3 T</b> - Fixed male and female jackscrews (Select 0 in Step 4) <b>*3 T6</b> - Fixed male and female polarized jackscrew (Select 0 in Step 4)
<b>STEP 3 - 1<sup>ST</sup> CONNECTOR GENDER</b> <b>*1 M</b> - Male S - Female - PosiBand closed entry contacts, see page 1 for more information.									<b>STEP 6 - 2<sup>ND</sup> CONNECTOR GENDER</b> M - Male
<b>*2 STEP 4 - 1<sup>ST</sup> CONNECTOR MATING STYLE</b> 0 - Swaged spacer 0.120 [3.05μ] mounting hole S - Swaged spacer 4-40 UNC-2B threads <b>*3 E</b> - Rotating male and female jackscrews (Select 0 in Step 7) <b>*3 E6</b> - Rotating male and female polarized jackscrew (Select 0 in Step 7) <b>*3 T</b> - Fixed male and female jackscrews (Select 0 in Step 7) <b>*3 T6</b> - Fixed male and female polarized jackscrew (Select 0 in Step 7)									<b>NOTES</b> <b>*1</b> Male option in Step 3 available only on connector variants 5W1, 3W3, 7W2, 11W1, 17W2, 21W1, 21WA4, 27W2, 24W7, 46W4. <b>*2</b> Connector mating style for both connectors must be the same if 0 or S is used. If E, E6, T or T6 is used in either Step 4 or 8 the other step must be 0. <b>*3</b> For hardware information, see page 64.
<b>STEP 5 - 1<sup>ST</sup> CONNECTOR HOUSING (SHELLS) OPTION</b> G - Gold over copper plate. D - Gold over copper plate and dimpled (male connectors only).									

Do you need 2-D drawings or 3-D models?

See page 18 for more information!



Positronic Industries  
connectpositronic.com



## UNIQUE FEATURES

High  
Performance  
D-sub

### UNIQUE FEATURE SECTION



Positronic Industries is **known** around the world for **offering** our customers **flexibility** when choosing connectors.

In addition to allowing **customers** to **create** part numbers for **particular applications**, Positronic offers a **wide variety** of features and accessories within our products.

Positronic is **able** to modify existing products **to meet unique customer requirements**. We are also eager to develop **custom connectors** for specific customer applications. If you do not find what you need in this catalog, please contact us for **assistance**.

### SEQUENTIAL MATING CONTACTS

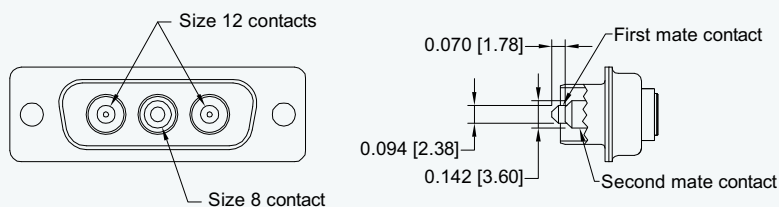

**Note:** A third level can be accomplished with signal contacts if needed.

#### Three levels of sequential mating are possible:

- First mate accomplished by a size 12 power contact. Male contact diameter is 0.094 inch. Contact Technical Sales for first mate size 8 (0.125 inch) diameter contacts.
- Second mate accomplished by a size 8 power contact. Male contact diameter is 0.142 inch.
- Third mate can be accomplished by size 20 signal contacts.

**CONTACT TECHNICAL SALES FOR MORE INFORMATION!**





**SIZE 8 CONTACT STABILIZATION FEATURE**  
MINIMIZES FLOAT IN SIZE 8 CONTACT POSITIONS

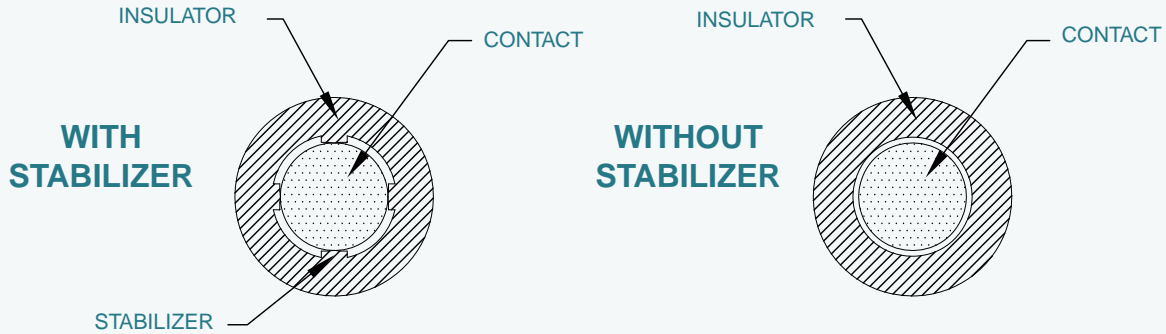

SCBM size 8 male contacts are removed toward the rear after utilizing front release tooling. Space must be provided between the contact and the connector molding so the tooling can slide over the mating portion of the contact. This fact allows the contact to float.

In some applications this float creates problems in alignment during mating. Many male contact SCBM variants offer an integral stabilizing feature to minimize problems created by float in size 8 contacts. An alternate tool is used to remove the contact if necessary. Tool number is 4311-0-1-0.

The stabilization feature is currently available for the following male contact variants:



SCBM3W3M



SCBM8W8M

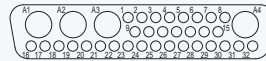

SCBC36W4M

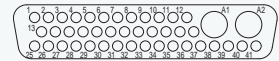

SCBC43W2M

Add MOS -1570.4 to end of part number. Example: SCBM3W3M00000-1570.4

**CONTACT TECHNICAL SALES FOR MORE INFORMATION!**

**SELECTIVELY LOADED CONNECTOR**

Select loading may be advantageous in applications requiring additional creepage and clearance distances.

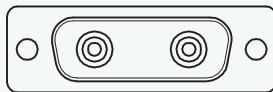

**SCBM3W3**  
loaded in 2 positions

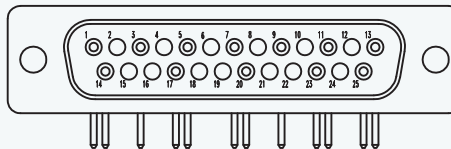

**SND25**  
loaded in 12 positions

**Note:**

SCBM3W3 and SND25 variants shown for reference. Selectively loading available on all series and variants.

**CONTACT TECHNICAL SALES FOR MORE INFORMATION!**



Positronic Industries  
connectpositronic.com



# UNIQUE FEATURES

High  
Performance  
D-sub

## CUSTOMER SPECIFIED CONTACT TERMINATION LENGTH

Positronic can supply high performance D-subminiature series connectors with customer specified termination lengths. A wide variety of options are available.

### STRAIGHT SOLDER PRINTED BOARD MOUNT

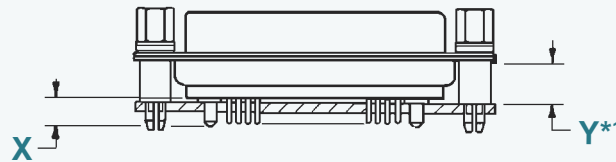

**Note:**

\*1 PCB spacer height can be adjusted according to contact termination length

### RIGHT ANGLE (90°) PRINTED BOARD MOUNT

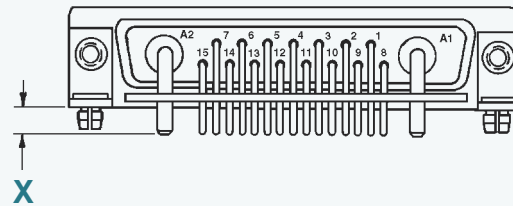

**Note:**

Combination-D variants shown for reference only. This option is available with SND, SDD, SCBM, SCBC and SCBCD.

**X and Y contact termination lengths can be custom designed to fit specific application requirements.**

**CONTACT TECHNICAL SALES FOR MORE INFORMATION!**

## LOW PROFILE INSULATOR

Positronic can supply high performance high density D-subminiature series connectors with a low profile insulator.

### LOW PROFILE

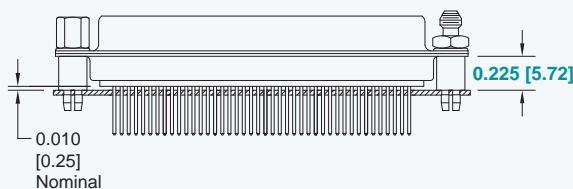

### STANDARD PROFILE

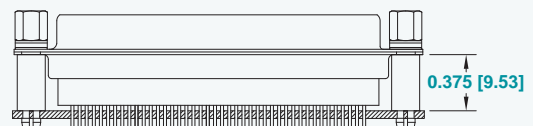

**CONTACT TECHNICAL SALES FOR MORE INFORMATION!**

UNIQUE FEATURES



COMPLIANT PRESS-IN CONNECTOR

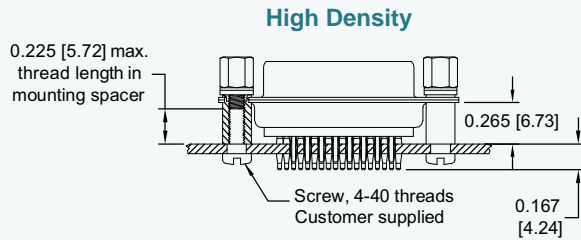
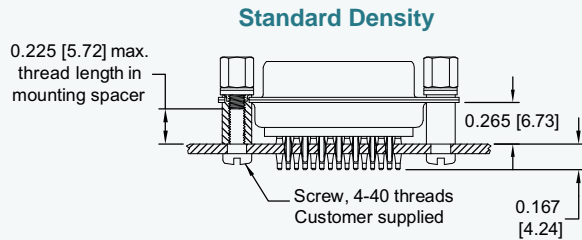

Customers may determine press-in terminations are a viable option based on their application parameters.

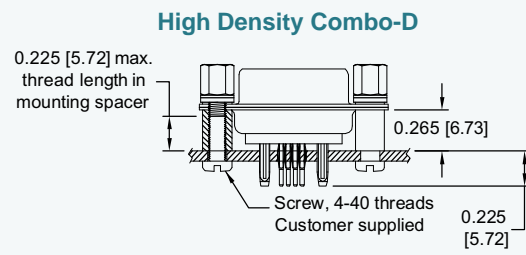
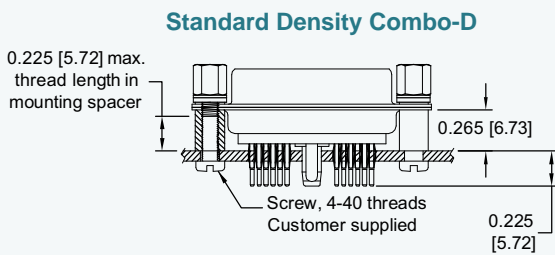

CONTACT TECHNICAL SALES FOR MORE INFORMATION!

DUAL PORT CONNECTOR

Connectors can be stacked to conserve printed circuit board space.

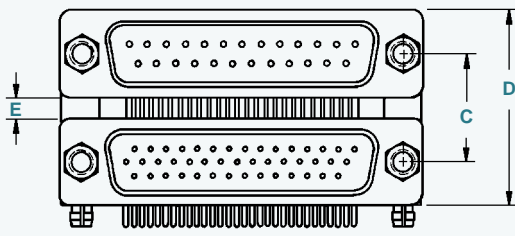

Standard density over high density shown for reference.



THREE HEIGHT OPTIONS!

SPACING BETWEEN CONNECTORS	C	D	E
OPTION 1	0.625 [15.88]	1.119 [28.42]	0.131 [3.33]
OPTION 2	0.750 [19.05]	1.244 [31.60]	0.256 [6.50]
OPTION 3	0.900 [22.86]	1.394 [35.41]	0.406 [10.31]

Connectors can be stacked in a variety of configurations:

- Standard / Standard Density
- High Density / High Density
- Standard / High Density
- Combination / Combination
- Combination / Standard or High Density

CONTACT TECHNICAL SALES FOR MORE INFORMATION!



Positronic Industries  
connectpositronic.com



# REMOVABLE CONTACTS

## MILITARY / SPACE FLIGHT QUALITY

High  
Performance  
D-sub

### REMOVABLE CONTACT TECHNICAL CHARACTERISTICS

#### SIZE 22 CONTACT

##### MATERIALS AND FINISHES:

Precision machined copper alloy. 0.000050 inch [1.27 microns] gold over copper plate. Other finishes are available; see page 95.

##### MECHANICAL CHARACTERISTICS:

Install contact to rear face of connector insert and remove from rear face of connector insert. Size 22 contacts, male – 0.030 inch [0.76 mm] mating diameter. Female contact - PosiBand closed entry design; see page 1 for details. Terminations for 20, 22, 24, 26, 28, and 30 AWG. Closed barrel crimp or solder.

##### ELECTRICAL CHARACTERISTICS:

For SDD series: For electrical characteristics, see page 14.  
For SCBCD series: For electrical characteristics, see page 58.

#### SIZE 20 CONTACT

##### MATERIALS AND FINISHES:

Precision machined copper alloy. 0.000050 inch [1.27 microns] gold over copper plate. Other finishes are available; see page 95.

##### MECHANICAL CHARACTERISTICS:

Install contact to rear face of connector insert and remove from rear face of connector insert. Size 20 contact, male – 0.040 inch [1.02 mm] mating diameter. Female contact - PosiBand closed entry design; see page 1 for details. Terminations for 18, 20, 22, 24, 26, 28, and 30 AWG. Closed barrel crimp or solder.

##### ELECTRICAL CHARACTERISTICS:

For SND series: For electrical characteristics, see page 6.  
For SCBC series: For electrical characteristics, see page 40.

#### SIZE 16 CONTACT

##### MATERIALS AND FINISHES:

Precision machined copper alloy. 0.000050 inch [1.27 microns] gold over copper plate. Other finishes are available; see page 95.

##### MECHANICAL CHARACTERISTICS:

Install contact to rear face of insulator, release from front face of insulator. Size 16 contacts, male – 0.062 inch [1.57mm] mating diameter. Female contact - PosiBand closed entry design; see page 1 for details. Terminations for 12, 14, 16, 18, 20, 22 and 24 AWG. Closed barrel crimp.

##### ELECTRICAL CHARACTERISTICS:

For electrical characteristics, see SCBCD series on page 58.

#### SIZE 8 CONTACT

##### MATERIALS AND FINISHES:

**POWER:** Precision machined copper alloy. 0.000050 inch [1.27 microns] gold over copper plate. Other finishes are available; see page 95.

##### HIGH VOLTAGE:

**Insulator Material:** PTFE teflon  
**Contacts:** Precision machined copper alloy. 0.000050 inch [1.27 microns] gold over copper plate. Other finishes are available; see page 95.

##### SHIELDED:

**Dielectric Material:** PTFE teflon  
**Inner Contacts:** Precision machined copper alloy. 0.000050 inch [1.27 microns] gold over copper plate. Other finishes are available; see page 95.  
**Outer Contacts:** Precision machined copper alloy. 0.000050 inch [1.27 microns] gold over copper plate. Other finishes are available; see page 95.

#### MECHANICAL CHARACTERISTICS:

##### POWER:

Install contact to rear face of connector insert and remove from front face of connector insert. Size 8 contacts, male – 0.142 inch [3.61 mm] mating diameter. Female contact - features Large Surface Area (L.S.A.) closed entry design utilizing BeCu mechanical retention member. Closed barrel crimp.

##### SHIELDED:

Install contact to rear face of insulator and remove from front face of insulator. Size 8 contacts. See page 84 table of cable sizes for contact termination dimensions.

##### Durability:

500 cycles minimum.

##### Vibration:

20g from 10 Hz to 500 Hz.

##### Shock:

30g-11ms.

##### HIGH VOLTAGE:

Install contact to rear face of insulator and remove from front face of insulator. Size 8 contacts. Straight and right angle (90°) terminations. 0.041 inch [1.04 mm] minimum hole diameter.

##### Durability:

500 cycles minimum.

##### Vibration:

20g from 10 Hz to 500 Hz.

##### Shock:

30g-11ms.

#### ELECTRICAL CHARACTERISTICS:

##### POWER:

For electrical characteristics, see page 21.

##### SHIELDED:

**Initial Contact Resistance:** 0.008 ohms maximum.

**Nominal Impedance:** 50 ohms.

**Insertion Loss:** -0.46 dB at 1 GHz

-1.5 dB at 2 GHz

##### VSWR:

1.15 average at 1 GHz

1.56 average at 2 GHz

Above values measured using frequency domain techniques.

##### Proof Voltage:

1000 V r.m.s.

##### HIGH VOLTAGE:

**Flash over Voltage:** 3600 V r.m.s.

**Proof Voltage:** 2700 V r.m.s.

**Initial Contact Resistance:** 0.008 ohms maximum.

#### OPTIONAL PLATING FINISHES

-54

0.000100 [2.54 μ] gold over copper by adding “-54” suffix onto part number. Example: FC6026M2-54.

#### REELED CONTACTS:

Contacts may be supplied in plastic carriers, packaged in reels holding 2,000 contacts for use with the automatic pneumatic crimp tools, catalog part number 9550-1. The same type carrier is used for both male and female contacts.

All male and female crimp contacts can be ordered in reels by adding letter “R” after the contact part number, such as MC4008MR for a male contact and FC120N4R-50 for female contact.



Enlarged section of plastic contact carriers

For information regarding CRIMP TOOLS & CRIMPING TOOL TECHNIQUES, see page 96.



**REMOVABLE CRIMP CONTACTS**

FOR USE WITH SDD AND SCBCD SERIES CONNECTORS

**SIZE 22**



*Note: Connectors can be kitted with all applicable crimp/solder contacts, contact Technical Sales for connector part number.*



**FEMALE CONTACT**  
"PosiBand" Closed Entry Design

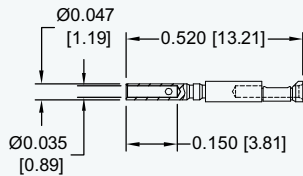

**MALE CONTACT**

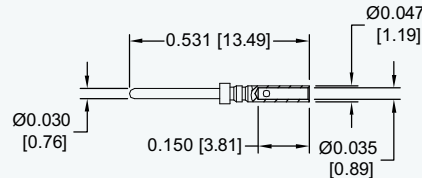

FEMALE PART NUMBER	WIRE SIZE AWG/[mm <sup>2</sup> ]
<b>FC8022M2</b>	22 / 24 / 26 / 28 / 30 [0.3/0.25/0.12/0.08/0.05]

MALE PART NUMBER	WIRE SIZE AWG/[mm <sup>2</sup> ]
<b>MC8022M</b>	22 / 24 / 26 / 28 / 30 [0.3/0.25/0.12/0.08/0.05]



**REMOVABLE CRIMP CONTACT**

FOR USE WITH SDD AND SCBCD SERIES CONNECTORS

CONTACTS USED WITH 20 AWG WIRE

**SIZE 22**



The crimp area of these contacts is not protected when fully seated in the connector molding. These contacts require shrink tubing after installation. Not suitable for fully loaded connector.

*Note: Connectors can be kitted with all applicable crimp/solder contacts, contact Technical Sales for connector part number.*

**FEMALE CONTACT**  
"PosiBand" Closed Entry Design

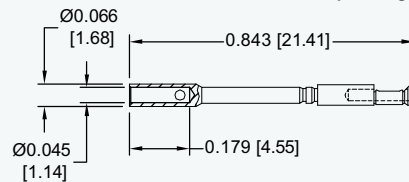

**MALE CONTACT**

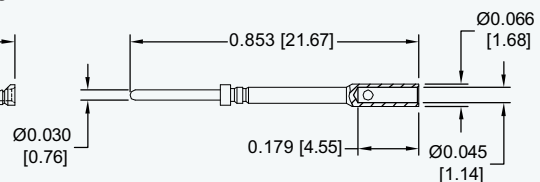

Crimp area extends above connector molding.



FEMALE PART NUMBER	WIRE SIZE AWG/[mm <sup>2</sup> ]
<b>FC8020M2</b>	20 [0.5] max



MALE PART NUMBER	WIRE SIZE AWG/[mm <sup>2</sup> ]
<b>MC8020M</b>	20 [0.5] max

For information regarding CRIMP TOOLS & CRIMPING TOOL TECHNIQUES, see page 96.



Positronic Industries  
connectpositronic.com



# REMOVABLE CONTACTS

## MILITARY / SPACE FLIGHT QUALITY

High  
Performance  
D-sub



### REMOVABLE CLOSED BARREL SOLDER CONTACTS

FOR USE WITH SDD AND SCBCD SERIES CONNECTORS

SIZE 22



Note: Connectors can be kitted with all applicable crimp/solder contacts, contact Technical Sales for connector part number.



#### FEMALE CONTACT

"PosiBand" Closed Entry Design

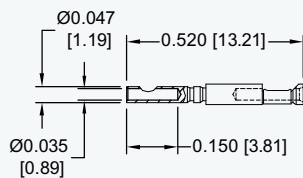

#### MALE CONTACT

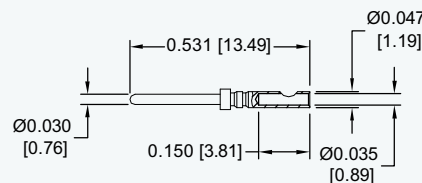

FEMALE PART NUMBER	WIRE SIZE AWG/[mm <sup>2</sup> ]
<b>FS8022M2</b>	22 [0.3] max

MALE PART NUMBER	WIRE SIZE AWG/[mm <sup>2</sup> ]
<b>MS8022M</b>	22 [0.3] max

### REMOVABLE CRIMP CONTACT

FOR USE WITH SND AND SCBC SERIES CONNECTORS

SIZE 20



Note: Connectors can be kitted with all applicable crimp/solder contacts, contact Technical Sales for connector part number.



#### FEMALE CONTACT

"PosiBand" Closed Entry Design

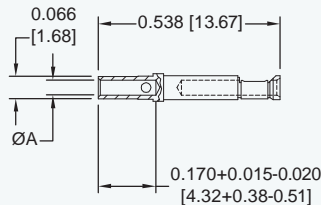

#### MALE CONTACT

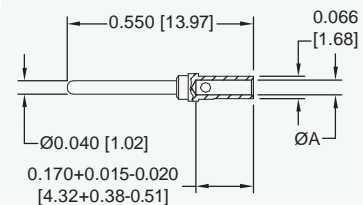

FEMALE PART NUMBER	WIRE SIZE AWG/[mm <sup>2</sup> ]	ØA
<b>FC6020M2</b>	20 / 22 / 24 [0.5/0.3/0.25]	0.045 [1.14]
<b>FC6026M2</b>	26 / 28 / 30 [0.12/0.08/0.05]	0.027 [0.69]

MALE PART NUMBER	WIRE SIZE AWG/[mm <sup>2</sup> ]	ØA
<b>MC6020M</b>	20 / 22 / 24 [0.5/0.3/0.25]	0.045 [1.14]
<b>MC6026M</b>	26 / 28 / 30 [0.12/0.08/0.05]	0.027 [0.69]

For information regarding CRIMP TOOLS & CRIMPING TOOL TECHNIQUES, see page 96.



**REMOVABLE CRIMP CONTACT**

FOR USE WITH SND AND SCBC SERIES CONNECTORS

CONTACTS USED WITH 18 AWG WIRE

**SIZE 20**



Authentic **POSITRONIC**  
**PosiBand**

*These contacts utilize authentic Positronic® PosiBand® technology.*

*Note: Connectors can be kitted with all applicable crimp/solder contacts, contact Technical Sales for connector part number.*

The crimp area of these contacts is not protected when fully seated in the connector molding. These contacts require shrink tubing after installation. Not suitable for fully loaded connector.



**FEMALE CONTACT**

“PosiBand” Closed Entry Design

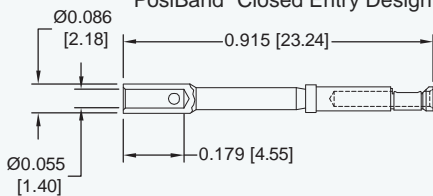

**MALE CONTACT**

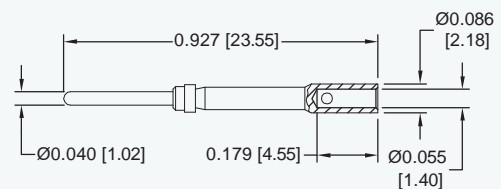

FEMALE PART NUMBER	WIRE SIZE AWG/[mm <sup>2</sup> ]
<b>FC6018M2</b>	18 [1.0] max

MALE PART NUMBER	WIRE SIZE AWG/[mm <sup>2</sup> ]
<b>MC6018M</b>	18 [1.0] max



**REMOVABLE CLOSED BARREL SOLDER CONTACTS**

FOR USE WITH SND AND SCBC SERIES CONNECTORS

**SIZE 20**



Authentic **POSITRONIC**  
**PosiBand**

*These contacts utilize authentic Positronic® PosiBand® technology.*

*Note: Connectors can be kitted with all applicable crimp/solder contacts, contact Technical Sales for connector part number.*



**FEMALE CONTACT**

“PosiBand” Closed Entry Design

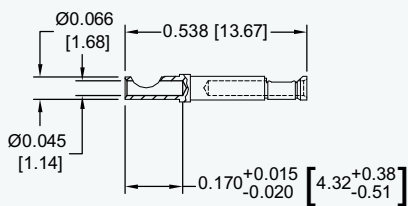

**MALE CONTACT**

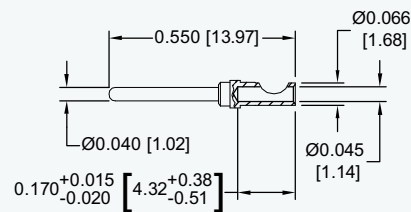

FEMALE PART NUMBER	WIRE SIZE AWG/[mm <sup>2</sup> ]
<b>FS6020M2</b>	20 [0.5] max

MALE PART NUMBER	WIRE SIZE AWG/[mm <sup>2</sup> ]
<b>MS6020M</b>	20 [0.5] max

For information regarding CRIMP TOOLS & CRIMPING TOOL TECHNIQUES, see page 96.



Positronic Industries  
connectpositronic.com



# REMOVABLE CONTACTS

## MILITARY / SPACE FLIGHT QUALITY

High  
Performance  
D-sub



### REMOVABLE CRIMP POWER CONTACT

#### FOR USE WITH SCBCD SERIES CONNECTORS

SIZE 16



Note: Connectors can be kitted with all applicable crimp/solder contacts, contact Technical Sales for connector part number.

#### FEMALE CONTACT

"PosiBand" Closed Entry Design

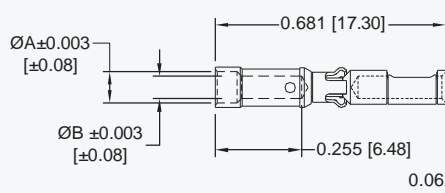

#### MALE CONTACT

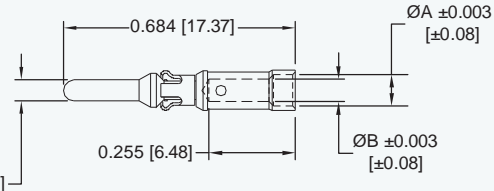

FEMALE PART NUMBER	WIRE SIZE [AWG] mm <sup>2</sup>	ØA	ØB
FC112N4-50	12 / [4.0]	N/A	0.098 [2.49]
FC114N4-50	14-16 [2.5-1.5]	0.105 [2.67]	0.081 [2.06]
FC116N4-50	16-18 [1.5-1.0]	0.093 [2.36]	0.067 [1.70]
FC120N4-50	20-22-24 [0.5-0.3-0.25]	0.065 [1.65]	0.045 [1.14]

MALE PART NUMBER	WIRE SIZE mm <sup>2</sup> [AWG]	ØA	ØB
MC112N-50-133.0	12 / [4.0]	N/A	0.098 [2.49]
MC114N-50-133.0	14-16 [2.5-1.5]	0.105 [2.67]	0.081 [2.06]
MC116N-50-133.0	16-18 [1.5-1.0]	0.093 [2.36]	0.067 [1.70]
MC120N-50-133.0	20-22-24 [0.5-0.3-0.25]	0.065 [1.65]	0.045 [1.14]

### REMOVABLE CRIMP POWER CONTACT

FOR USE WITH SCBM, SCBC, SCBDD AND SCBCD SERIES CONNECTORS

SIZE 8

For contact current rating, see page 21.

Note: Connectors can be kitted with all applicable crimp/solder contacts, contact Technical Sales for connector part number.

#### \*1 FEMALE CONTACT

"CLOSED ENTRY" DESIGN, L.S.A.

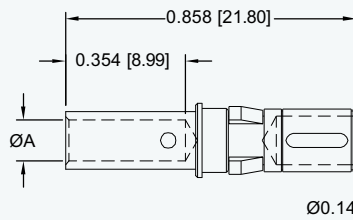
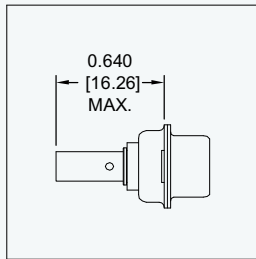

#### MALE CONTACT

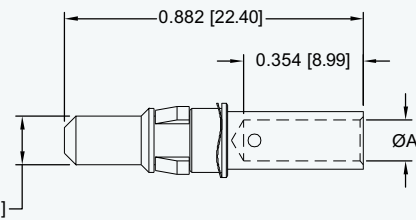

FEMALE PART NUMBER	WIRE SIZE [AWG] mm <sup>2</sup>	Ø A
FC4008M	8 [10.0]	0.181 [4.60]
FC4010M	10 [5.3]	0.122 [3.10]
FC4012M	12 [4.0]	0.101 [2.57]
FC4016M	16 [1.5]	0.067 [1.70]

MALE PART NUMBER	WIRE SIZE [AWG] mm <sup>2</sup>	Ø A
MC4008M	8 [10.0]	0.181 [4.60]
MC4010M	10 [5.3]	0.122 [3.10]
MC4012M	12 [4.0]	0.101 [2.57]
MC4016M	16 [1.5]	0.067 [1.70]

NOTE: \*1 Female contacts feature Large Surface Area (L.S.A.) closed entry contact design which provides maximum mating surfaces between male and female contact and reduced contact resistance during operation.

For information regarding CRIMP TOOLS & CRIMPING TOOL TECHNIQUES, see page 96.





**REMOVABLE SOLDER CUP POWER CONTACT**  
FOR USE WITH SCBM, SCBC, SCBDD AND SCBCD SERIES CONNECTORS

**SIZE 8**

For contact current rating, see page 21

Note: Connectors can be kitted with all applicable crimp/solder contacts, contact Technical Sales for connector part number.

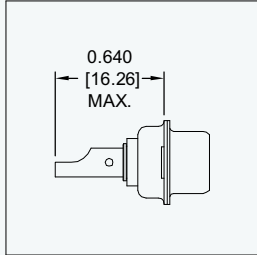

**\*1 FEMALE CONTACT**  
"CLOSED ENTRY" DESIGN, L.S.A.

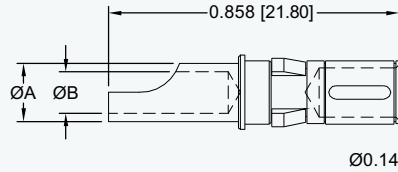

**MALE CONTACT**

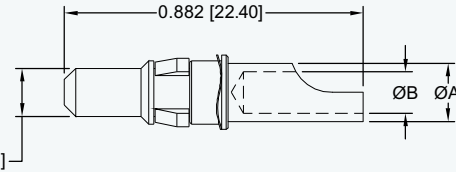

FEMALE PART NUMBER	WIRE SIZE [AWG] mm <sup>2</sup>	Ø A	Ø B
FS4008M	8 [10.0]	0.219 [5.56]	0.188 [4.78]
FS4012M	12 [4.0]	0.143 [3.63]	0.112 [2.84]
FS4016M	16 [1.5]	0.100 [2.54]	0.069 [1.75]

MALE PART NUMBER	WIRE SIZE [AWG] mm <sup>2</sup>	Ø A	Ø B
MS4008M	8 [10.0]	0.219 [5.56]	0.188 [4.78]
MS4012M	12 [4.0]	0.143 [3.63]	0.112 [2.84]
MS4016M	16 [1.5]	0.100 [2.54]	0.069 [1.75]

**NOTE:** \*1 Female contacts feature Large Surface Area (L.S.A.) closed entry contact design which provides maximum mating surfaces between male and female contact and reduced contact resistance during operation.

**STRAIGHT SOLDER PRINTED BOARD MOUNT POWER CONTACT**  
FOR USE WITH SCBM AND SCBDD SERIES CONNECTORS

**SIZE 8**

For contact current rating, see page 21.

Note: Connectors can be kitted with all applicable crimp/solder contacts, contact Technical Sales for connector part number.

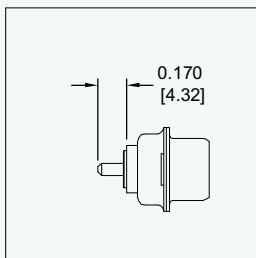

**\*1 FEMALE CONTACT**  
"CLOSED ENTRY" DESIGN, L.S.A.

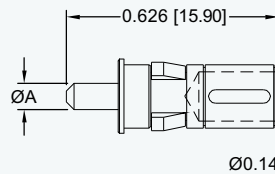

**MALE CONTACT**

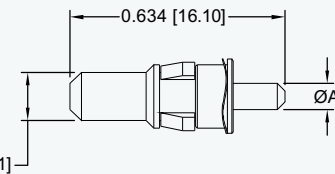

FEMALE PART NUMBER	Ø A	CONTACT CODE
FDS4314M	0.078 [1.98]	35
<b>NEW!</b> FDS4312M	0.094 [2.39]	36
FDS4310M	0.125 [3.18]	37

MALE PART NUMBER	Ø A	CONTACT CODE
MDS4314M	0.078 [1.98]	35
<b>NEW!</b> MDS4312M	0.094 [2.39]	36
MDS4310M	0.125 [3.18]	37

**NOTE:** \*1 Female contacts feature Large Surface Area (L.S.A.) closed entry contact design which provides maximum mating surfaces between male and female contact and reduced contact resistance during operation.

For information regarding CRIMP TOOLS & CRIMPING TOOL TECHNIQUES, see page 96.



Positronic Industries  
connectpositronic.com



# REMOVABLE CONTACTS

## MILITARY / SPACE FLIGHT QUALITY

High  
Performance  
D-sub

### RIGHT ANGLE (90°) PRINTED BOARD MOUNT POWER CONTACT

FOR USE WITH SCBM AND SCBDD SERIES CONNECTORS

SIZE 8

For contact current rating, see page 21

\*1 FEMALE CONTACT

"CLOSED ENTRY" DESIGN, L.S.A.

MALE CONTACT

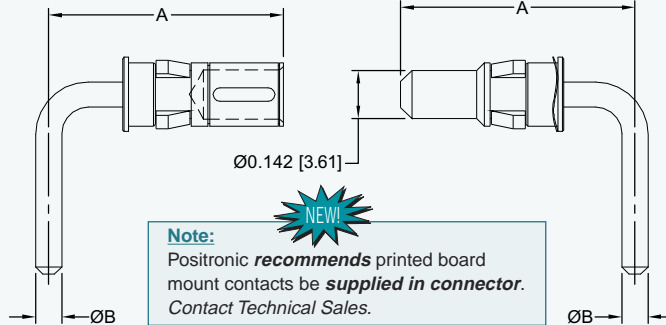
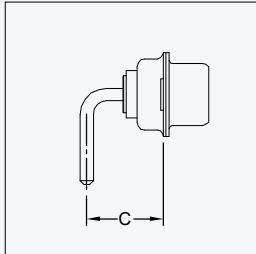

**Note:**  
Positronic **recommends** printed board mount contacts be **supplied in connector**.  
Contact Technical Sales.

**NOTE:**

\*1 Female contacts feature Large Surface Area (L.S.A.) closed entry contact design which provides maximum mating surfaces between male and female contact and reduced contact resistance during operation.

FEMALE PART NUMBER	A REF.	Ø B	C	SHELL SIZE	CONTACT CODE
FRT4314M	0.580 [14.73]	0.078 [1.98]	0.339 [8.61]	1, 2, 3 & 4	55
FRT4414M	0.692 [17.58]	0.078 [1.98]	0.451 [11.46]	5	55
FRT4714M	0.661 [16.79]	0.078 [1.98]	0.420 [10.67]	1, 2, 3 & 4	75
FRT4814M	0.773 [19.63]	0.078 [1.98]	0.520 [13.21]	5	75
FRT4310M	1.051 [26.70]	0.125 [3.18]	0.810 [20.57]	1, 2, 3 & 4	57, 77
FRT4410M	1.051 [26.70]	0.125 [3.18]	0.810 [20.57]	5	57, 77

MALE PART NUMBER	A REF.	Ø B	C	SHELL SIZE	CONTACT CODE
MRT4314M	0.580 [14.73]	0.078 [1.98]	0.339 [8.61]	1, 2, 3 & 4	55
MRT4414M	0.692 [17.58]	0.078 [1.98]	0.451 [11.46]	5	55
MRT4714M	0.661 [16.79]	0.078 [1.98]	0.420 [10.67]	1, 2, 3 & 4	75
MRT4814M	0.773 [19.63]	0.078 [1.98]	0.520 [13.21]	5	75
MRT4310M	1.051 [26.70]	0.125 [3.18]	0.810 [20.57]	1, 2, 3 & 4	57, 77
MRT4410M	1.051 [26.70]	0.125 [3.18]	0.810 [20.57]	5	57, 77

*Note: Connectors can be kitted with all applicable crimp/solder contacts, contact Technical Sales for connector part number.*

### REMOVABLE HIGH VOLTAGE POWER CONTACT

FOR USE WITH SCBM, SCBC, SCBDD AND SCBCD SERIES CONNECTORS

SIZE 8

#### STRAIGHT SOLDER WIRE TERMINATION

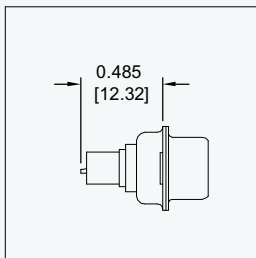

FEMALE CONTACT

MALE CONTACT

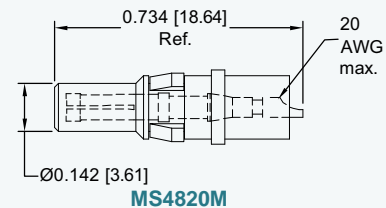
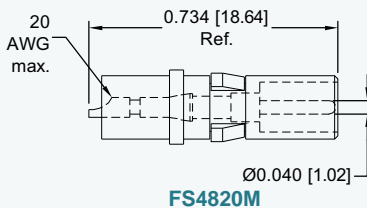

#### RIGHT ANGLE (90°) SOLDER WIRE TERMINATION

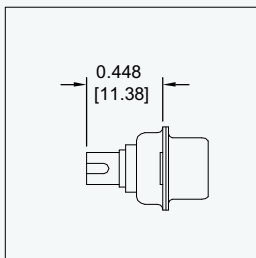

FEMALE CONTACT

MALE CONTACT

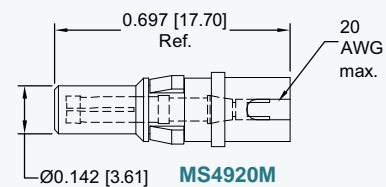
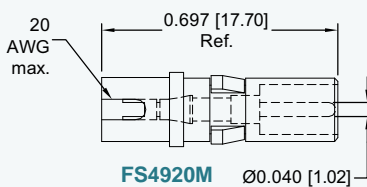

For information regarding CRIMP TOOLS & CRIMPING TOOL TECHNIQUES, see page 96.



**REMOVABLE SHIELDED CONTACT**

FOR USE WITH SCBM, SCBC, SCBDD AND SCBCD SERIES CONNECTORS

SIZE 8

**STRAIGHT SOLDER/CRIMP CONTACTS**

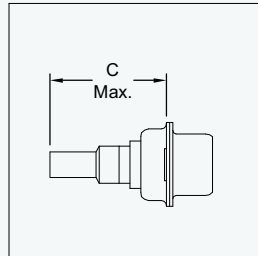

FEMALE CONTACT

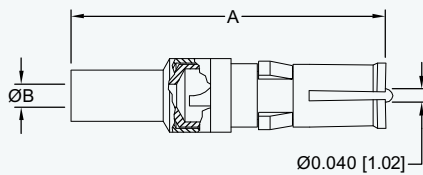

MALE CONTACT

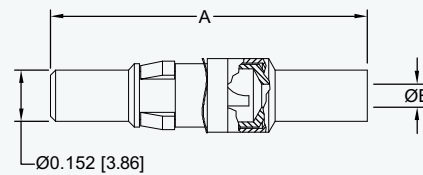

**STRAIGHT SOLDER/SOLDER CONTACTS**

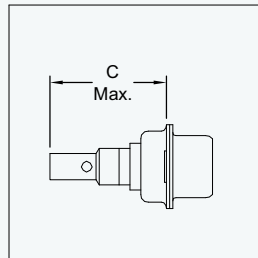

FEMALE CONTACT

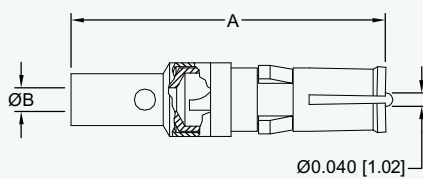

MALE CONTACT

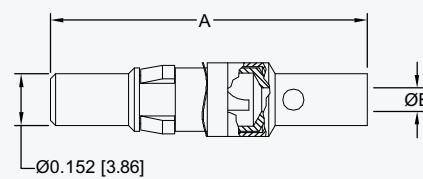

**STRAIGHT CRIMP/CRIMP CONTACTS**

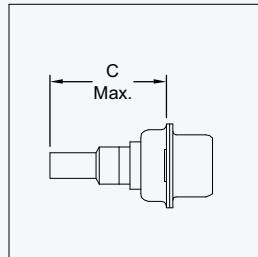

FEMALE CONTACT

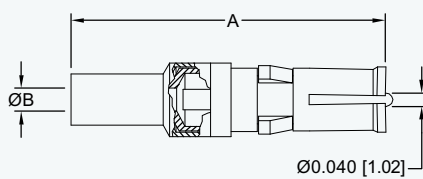

MALE CONTACT

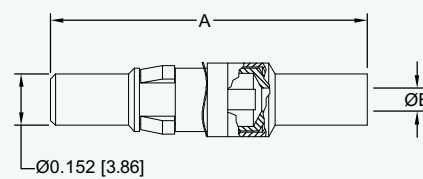

TYPE OF CONTACT	FEMALE PART NUMBER	MALE PART NUMBER	A	Ø B	C MAX.	RG CABLE NUMBER
SOLDER/CRIMP	FC4101M	MC4101M	0.929 [23.60]	0.040 [1.02]	0.739 [18.77]	178 B/U 196 B/U
	FC4102M	MC4102M	0.929 [23.60]	0.067 [1.70]	0.739 [18.77]	179 B/U 316 /U
	FC4103M	MC4103M	1.037 [26.34]	0.108 [2.74]	0.847 [21.51]	180 B/U
	FC4104M	MC4104M	1.037 [26.34]	0.120 [3.05]	0.847 [21.51]	58 B/U
SOLDER/SOLDER	FS4101M	MS4101M	0.929 [23.60]	0.040 [1.02]	0.739 [18.77]	178 B/U 196 B/U
	FS4102M	MS4102M	0.929 [23.60]	0.067 [1.70]	0.739 [18.77]	179 B/U 316 /U
	FS4103M	MS4103M	1.037 [26.34]	0.108 [2.74]	0.847 [21.51]	180 B/U
	FS4104M	MS4104M	1.037 [26.34]	0.120 [3.05]	0.847 [21.51]	58 B/U
CRIMP/CRIMP	FCC4101M	MCC4101M	0.929 [23.60]	0.040 [1.02]	0.739 [18.77]	178 B/U 196 B/U
	FCC4102M	MCC4102M	0.929 [23.60]	0.067 [1.70]	0.739 [18.77]	179 B/U 316 /U
	FCC4103M	MCC4103M	1.037 [26.34]	0.108 [2.74]	0.847 [21.51]	180 B/U
	FCC4104M	MCC4104M	1.037 [26.34]	0.120 [3.05]	0.847 [21.51]	58 B/U

Note: Connectors can be kitted with all applicable crimp/solder contacts, contact Technical Sales for connector part number.



**SHIELDED CONTACTS**

Two-step crimping action for signal and shielding conductors.

For information regarding CRIMP TOOLS & CRIMPING TOOL TECHNIQUES, see page 96.



Positronic Industries  
connectpositronic.com



# REMOVABLE CONTACTS

## MILITARY / SPACE FLIGHT QUALITY

High  
Performance  
D-sub

### STRAIGHT SOLDER PRINTED BOARD MOUNTED SHIELDED CONTACT FOR USE WITH SCBM AND SCBDD SERIES CONNECTORS SIZE 8

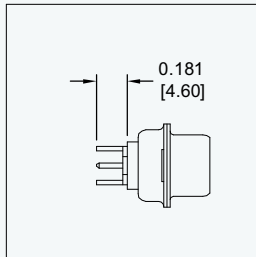

Suggest  $\varnothing 0.045$   
[1.14] hole

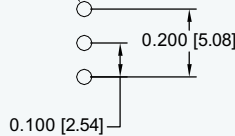

CONTACT HOLE PATTERN

#### FEMALE CONTACT

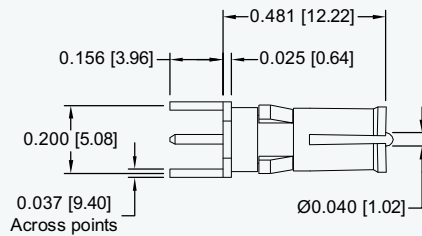

FDS4201M

#### MALE CONTACT

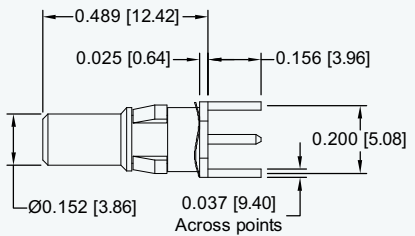

MDS4201M

**Note:**

Positronic **recommends** printed board mount contacts be **supplied in connector**.  
Contact Technical Sales.

### RIGHT ANGLE (90°) PRINTED BOARD MOUNT SHIELDED CONTACTS FOR USE WITH SCBM AND SCBDD SERIES CONNECTORS SIZE 8

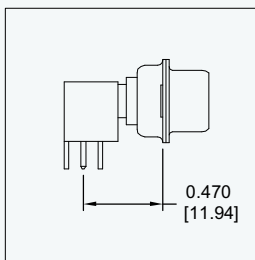

Suggest  $\varnothing 0.045$   
[1.14] hole

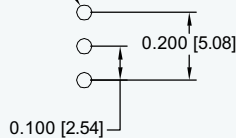

CONTACT HOLE PATTERN

#### FEMALE CONTACT

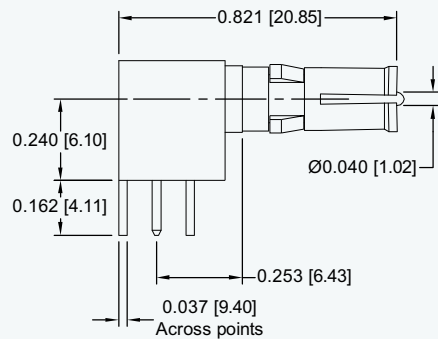

FRT4201M

#### MALE CONTACT

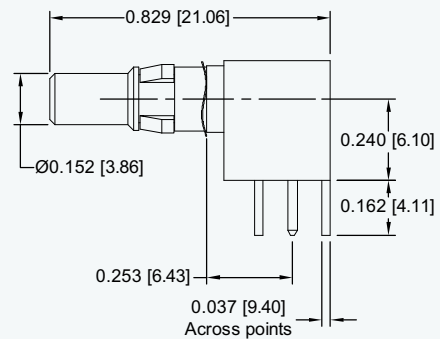

MRT4201M

**Note:**

Positronic **recommends** printed board mount contacts be **supplied in connector**.  
Contact Technical Sales.

For information regarding CRIMP TOOLS & CRIMPING TOOL TECHNIQUES, see page 96.



**RIVETED ON RIGHT ANGLE (90°) MOUNTING BRACKETS WITH CROSS BAR  
CODE R2, R6, R7 AND R8**

CONTACT ALIGNMENT BAR IS SUPPLIED WITH R2, R6, R7, AND R8. EXCEPTION: SCBM2WK2, SCBM3W3, SCBM3WK3, SCBM5W5 AND SCBM8W8 VARIANTS. SEE PAGE 38 FOR MORE INFORMATION.

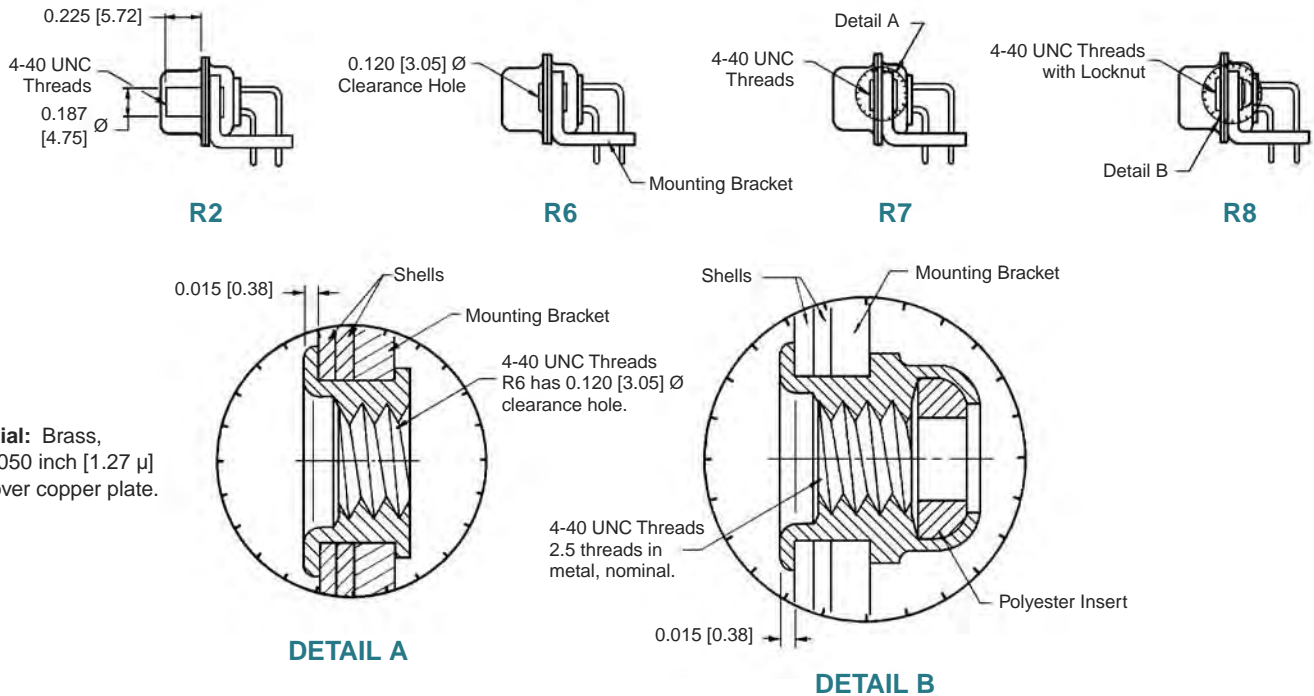

**Material:** Brass,  
0.000050 inch [1.27 μ]  
gold over copper plate.

**PUSH-ON FASTENER FOR RIVETED ON RIGHT ANGLE (90°) MOUNTING BRACKETS  
CODE N**



**SCBM17W2S5R7N0G**  
(shown left)

**SDD26S4R7N0G**  
(shown right)

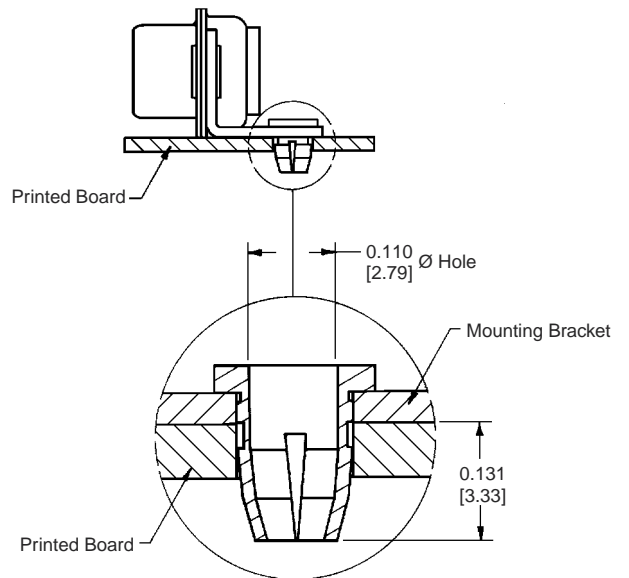

Printed board mounting hole to be 0.123 [3.12] Ø ±0.003 for use with push-on fastener.

**Material:** Beryllium copper, 0.000050 inch [1.27 μ]  
gold over copper plate.

TYPICAL PERFORMANCE EVALUATION DATA			
SAMPLE #	PRINTED BOARD HOLE Ø	INSERTION FORCE [LBS.]	RETENTION FORCE [LBS.]
1	0.120 [3.05]	7-1/4	5-3/4
2	0.123 [3.12]	5-3/4	5-1/2
3	0.125 [3.18]	2-3/4	2-1/2
4	0.128 [3.25]	1-3/4	2-1/4
5	0.126 [3.20] PLATED	1-3/4	2-1/4



Positronic Industries  
connectpositronic.com

# ACCESSORIES

## MILITARY / SPACE FLIGHT QUALITY

High  
Performance  
D-sub

### RIGHT ANGLE (90°) METAL MOUNTING BRACKET CODE B3

PART NO.	STYLE	A	B	C	D	SIZE	SND	SDD	SCBM	SCBDD
4535-2-0	1	0.324 [8.23]	0.484 [12.29]	0.244 [6.20]	0.358 [9.09]	9-37	5		5, 55, 57	
4535-3-0	1	0.380 [9.65]	0.594 [15.09]	0.303 [7.70]	0.417 [10.59]	50	5		5, 55, 57	
4535-5-0	3	0.554 [14.07]	0.739 [18.77]	0.244 [6.20]	0.358 [9.09]	15-62		4		
4535-6-0	3	0.604 [15.34]	0.800 [20.32]	0.303 [7.70]	0.417 [10.59]	78		4		
4535-8-0	2	0.405 [10.29]	0.522 [13.26]	0.246 [6.25]	0.358 [9.09]	9-37	42		7, 75, 77	
4535-9-0	2	0.455 [11.56]	0.572 [14.53]	0.303 [7.70]	0.414 [10.52]	50	42		7, 75, 77	
4535-32-0	2	0.399 [10.13]	0.516 [13.11]	0.246 [6.25]	0.358 [9.09]	15-62				4
4535-33-0	2	0.399 [10.13]	0.516 [13.11]	0.303 [7.70]	0.414 [10.52]	78				4
4535-62-0	2	0.614 [15.60]	0.731 [18.57]	0.334 [8.48]	0.445 [11.30]	104		4		

**NOTE:** Sold only as part of a connector assembly.

**Note:** Contact alignment bar is supplied with B3 option.

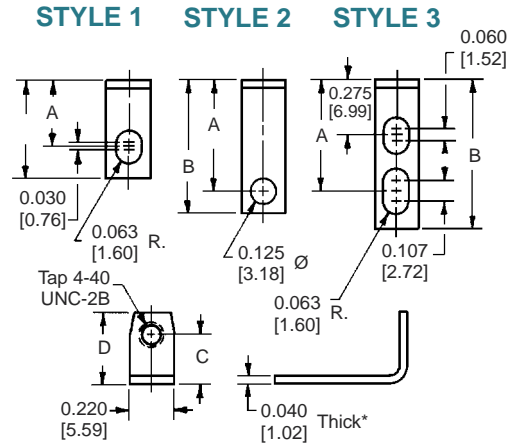

\*0.062 [1.57] thick for Size 104 SDD series and SCBM46W4 variant.

**Material:** Brass, 0.000050 inch [1.27 μ] gold over copper plate.

### RIGHT ANGLE (90°) METAL MOUNTING BRACKET SUPPLIED WITH R, R2, R3, R4, R5, R6, R7 AND R8 RIVETED-ON BRACKET ASSEMBLIES CODE R, R2, R3, R4, R5, R6, R7 AND R8

PART NO.	A	B	C	D	SIZE	SND	SDD	SCBM	SCBDD
4535-2-1	0.339 [8.61]	0.456 [11.58]	0.246 [6.25]	0.358 [9.09]	9 - 37	5		5, 55, 57	
4535-3-1	0.395 [10.03]	0.512 [13.00]	0.303 [7.70]	0.414 [10.52]	50	5		5, 55, 57	
4535-8-1	0.420 [10.67]	0.537 [13.64]	0.246 [6.25]	0.358 [9.09]	9 - 37	42		7, 75, 77	
4535-9-1	0.470 [11.94]	0.587 [14.91]	0.303 [7.70]	0.414 [10.52]	50	42		7, 75, 77	
4535-32-1	0.414 [10.52]	0.531 [13.49]	0.246 [6.25]	0.358 [9.09]	15-62				4
4535-33-1	0.414 [10.52]	0.531 [13.49]	0.303 [7.70]	0.414 [10.52]	78				4
4535-34-1	0.528 [13.41]	0.645 [16.38]	0.246 [6.25]	0.358 [9.09]	15 - 62		4		
4535-35-1	0.573 [14.55]	0.690 [17.53]	0.303 [7.70]	0.414 [10.52]	78		4		
4535-62-1	0.614 [15.60]	0.731 [18.57]	0.334 [8.48]	0.445 [11.30]	104		4		

**NOTE:** Sold only as part of a connector assembly.

**Note:** Contact alignment bar is supplied with R2, R6, R7 and R8 options only.

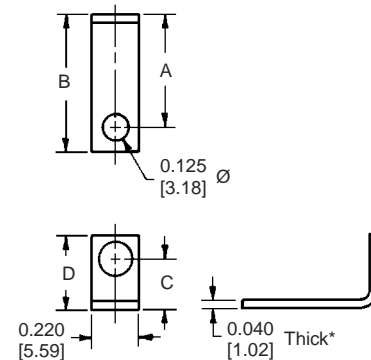

\*0.062 [1.57] thick for Size 104 SDD series and SCBM46W4 variant.

**Material:** Brass, 0.000050 inch [1.27 μ] gold over copper plate.



**SWAGED SPACER  
CODE S**

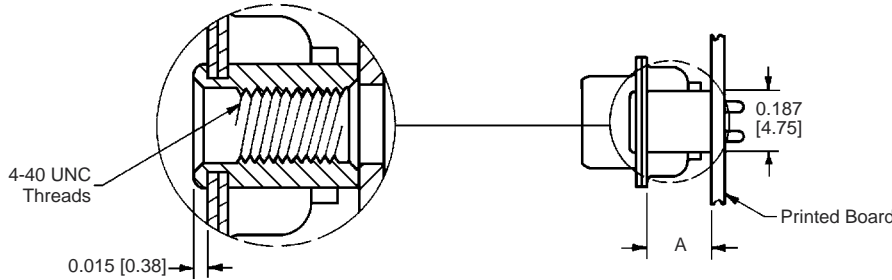

**Material:** Brass, 0.000050 inch [1.27 μ] gold over copper plate.

CONNECTOR SERIES	*1 CODE NUMBER	A
SND	0, 1, 12	0.375 [9.53]
	2, 3, 32, 36, 42, 5	0.225 [5.72]
SDD	0, 1, 3, 32, 4	0.375 [9.53]
SCBM	0, 2, 3, 35, 36, 37, 5, 55, 57, 65, 7, 75, 77, 85	0.250 [6.35]
SCBC	0, 1, 12, 13, 14	0.375 [9.53]
SCBDD	21, 3, 35, 36, 37, 4, 45, 47, 65, 84	0.250 [6.35]
SCBCD	0, 1, 12, 13, 14	0.375 [9.53]

**NOTE:**

\*1 Contact termination code as specified in Step 4 of ordering information.

**SWAGED SPACER  
CODE S2**

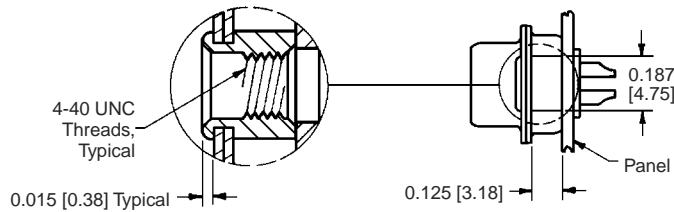

**Material:** Brass, 0.000050 inch [1.27 μ] gold over copper plate.

**SWAGED LOCKNUT  
CODE S5**

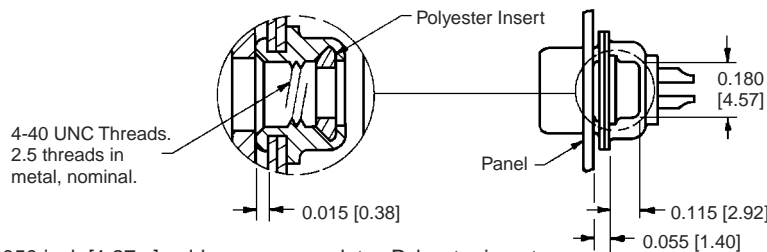

**Material:** Brass, 0.000050 inch [1.27 μ] gold over copper plate. Polyester insert.

**SWAGED SPACER WITH PUSH-ON FASTENER  
CODE S6**

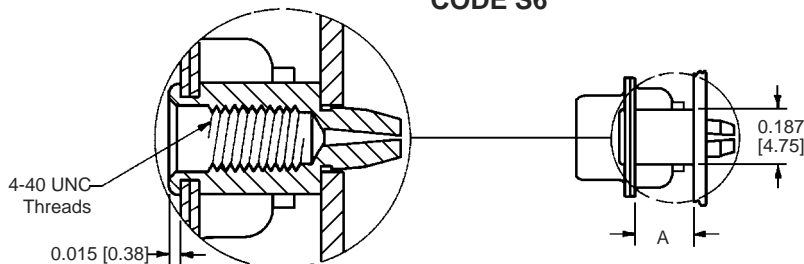

Printed board mounting hole to be 0.123 [3.12] Ø ±0.003 for use with push-on fastener.

**Material:** Phosphor bronze, 0.000050 inch [1.27 μ] gold over copper plate.

CONNECTOR SERIES	*1 CODE NUMBER	A
SND	0, 1, 12	0.375 [9.53]
	2, 3, 32, 36, 42, 5	0.225 [5.72]
SDD	0, 1, 3, 32, 4	0.375 [9.53]
SCBM	0, 2, 3, 35, 36, 37, 5, 55, 57, 65, 7, 75, 77, 85	0.250 [6.35]
SCBC	0, 1, 12, 13, 14	0.375 [9.53]
SCBDD	21, 3, 35, 36, 37, 4, 45, 47, 65, 84	0.250 [6.35]
SCBCD	0, 1, 12, 13, 14	0.375 [9.53]

**NOTE:**

\*1 Contact termination code as specified in Step 4 of ordering information.



Positronic Industries  
connectpositronic.com

# ACCESSORIES

## MILITARY / SPACE FLIGHT QUALITY

High  
Performance  
D-sub

### THREADED POST CODE P

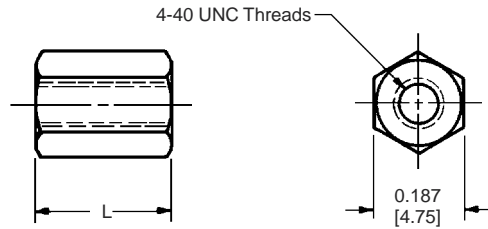

CONNECTOR SERIES	*1 CODE NUMBER	A
SND	0, 1, 12	0.375 [9.53]
	2, 3, 32, 36, 42, 5	0.225 [5.72]
SDD	0, 1, 3, 32, 4	0.375 [9.53]
SCBM	0, 2, 3, 35, 36, 37, 5, 55, 57, 65, 7, 75, 77, 85	0.250 [6.35]
SCBC	0, 1, 12, 13, 14	0.375 [9.53]
SCBDD	21, 3, 35, 36, 37, 4, 45, 47, 65, 84	0.250 [6.35]
SCBCD	0, 1, 12, 13, 14	0.375 [9.53]

**Material:** Brass, 0.000050 inch [1.27 μ] gold over copper plate.

**NOTE:**

\*1 Contact termination code as specified in Step 4 of ordering information.

### CUL-DE-SAC STYLE MOUNTING ACCESSORIES CODE C5 AND C7

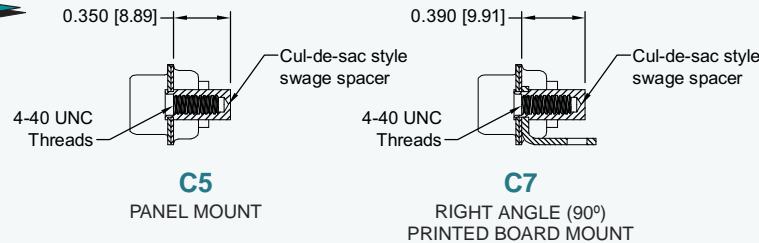

**Material:** Brass, 0.000050 inch [1.27 μ] gold over copper plate.

### IN-LINE CRIMP SPLICE

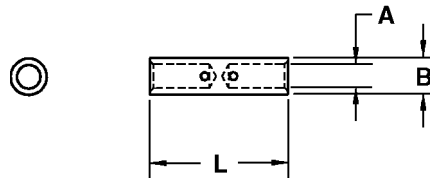

Consult Technical Sales for crimp tool part number.

**NOTE:**

\*1 To order crimp splice with insulating sleeve, add "-W" suffix to part number. To order without sleeve, add "-N" suffix.

PART NUMBER	WIRE SIZE AWG / [mm <sup>2</sup> ]	L	A	B
PSK43636-*1	20-26 [0.5/0.12]	0.500 [12.70]	0.045 [1.14]	0.076 [1.93]
PSK43637-*1	16-20 [1.5/0.5]	0.575 [14.61]	0.066 [1.68]	0.101 [2.57]
PSK43638-*1	12-18 [4.0-1.0]	0.577 [14.66]	0.097 [2.46]	0.150 [3.81]

**Materials:**

**Splice:** Copper alloy, 0.000050 [1.27 μ] gold over copper.

**Sleeve:** Shrink-fit polyvinylidene fluoride.





**BLIND MATING SYSTEM**

**BLIND MATING GUIDES**

TO OBTAIN BLIND MATING GUIDES, ADD THE SUFFIX  
"-759.42" TO THE END OF THE PART NUMBER.

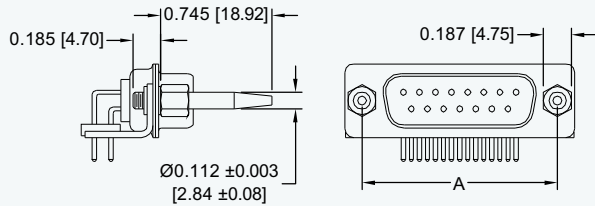

**TYPICAL PART NUMBER:**  
**SND15M5R700G-759.42**

**Material:** Brass, 0.000050 inch [1.27 μ] gold over copper plate.

CONNECTOR VARIANT (SHELL SIZE)	A	B	C	D	E
<b>9/15</b> (SHELL SIZE 1)	0.984 [24.99]	1.586 [40.28]	1.333 [33.86]	1.930 [49.02]	0.677 [17.20]
<b>15/26</b> (SHELL SIZE 2)	1.312 [33.32]	1.914 [48.62]	1.661 [42.19]	2.258 [57.35]	0.677 [17.20]
<b>25/44</b> (SHELL SIZE 3)	1.852 [47.04]	2.461 [62.51]	2.208 [56.08]	2.805 [71.25]	0.677 [17.20]
<b>37/62</b> (SHELL SIZE 4)	2.500 [63.50]	3.102 [78.79]	2.849 [72.36]	3.446 [87.53]	0.677 [17.20]
<b>50/78</b> (SHELL SIZE 5)	2.406 [61.11]	3.008 [76.40]	2.755 [69.98]	3.352 [85.14]	0.789 [20.04]

**PANEL MOUNTING**

TO OBTAIN PANEL MOUNTING, ADD THE SUFFIX  
"-759.43" TO THE END OF THE PART NUMBER.

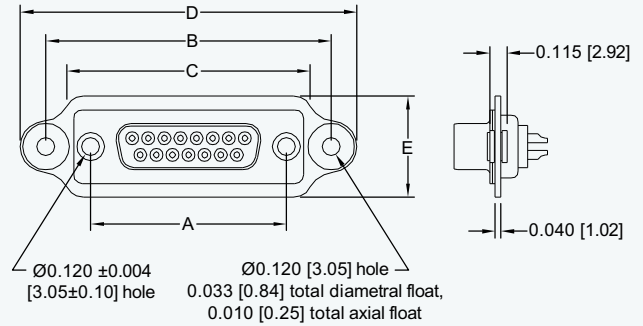

**TYPICAL PART NUMBER:**  
**SND15S2000G-759.43**

**Material:** Aluminum, yellow anodize standard.

**METAL CABLE ADAPTER (HOOD)**  
**CODE H**

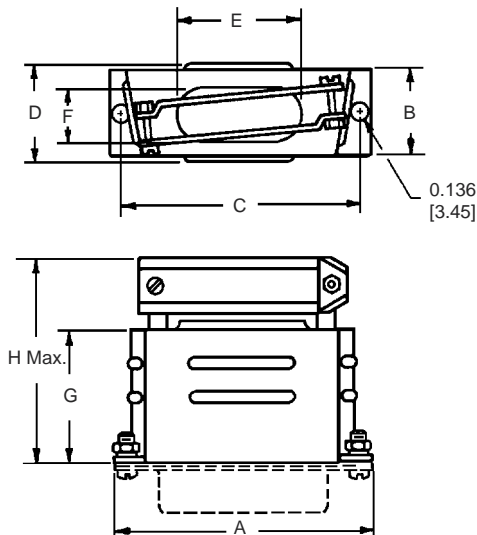

**TYPICAL PART NUMBER:**  
**SND15M00HG**

CONNECTOR VARIANT (SHELL SIZE)	PART NO.	A	B	C	D MAX.	E	F	G	H MAX.
<b>15/26</b> (SHELL SIZE 2)	<b>SND15000HG</b>	1.531 [38.88]	0.492 [12.50]	1.312 [33.32]	0.578 [14.68]	0.713 [18.11]	0.312 [7.92]	0.750 [19.05]	1.219 [30.96]
<b>25/44</b> (SHELL SIZE 3)	<b>SND25000HG</b>	2.078 [52.78]	0.492 [12.50]	1.852 [47.04]	0.578 [14.68]	1.000 [25.40]	0.312 [7.92]	1.000 [25.40]	1.532 [38.91]
<b>37/62</b> (SHELL SIZE 4)	<b>SND37000HG</b>	2.718 [69.03]	0.492 [12.50]	2.500 [63.50]	0.578 [14.68]	1.375 [34.93]	0.312 [7.92]	1.000 [25.40]	1.532 [38.91]
<b>50/78</b> (SHELL SIZE 5)	<b>SND50000HG</b>	2.625 [66.68]	0.601 [15.27]	2.406 [61.11]	0.687 [17.45]	1.406 [35.71]	0.406 [10.31]	1.125 [28.58]	1.657 [42.09]

**Material:** Brass, 0.000050 inch [1.27 μ] gold over copper plate.



Positronic Industries  
connectpositronic.com

# ACCESSORIES

## MILITARY / SPACE FLIGHT QUALITY

High  
Performance  
D-sub



### LIGHTWEIGHT ALUMINUM CABLE ADAPTER (HOOD)

CODE AN

#### TECHNICAL CHARACTERISTICS

##### MATERIAL AND FINISHES:

**Hood & Cable Clamps:** Aluminum with electroless nickel plate. Zinc content is 1% maximum.

**Jackscrews & Screws:** Brass, 0.000050 inch [1.27 μ] gold over copper plate.

*Other plating and finishes are available, contact Technical Sales.*

##### MECHANICAL CHARACTERISTICS:

**Ground Screws:** Can accept up to 0.250 inch [6.35mm] diameter ring terminal.

**Locking System:** Jackscrews, see below and page 92 for more information.

##### CLIMATIC CHARACTERISTICS:

**Temperature Range:** -55°C to +125°C

##### ELECTRICAL CHARACTERISTICS:

**Range of Operation, Calculated Method:** 2 GHz minimum.

##### WEIGHT CHART:

HOOD SIZE	D*1000ANE ounces [grams]
9	1.08 [30.54]
15	1.32 [37.44]
25	1.62 [45.92]
37	2.19 [62.06]
50	2.26 [63.94]
104	2.41 [68.44]

All hardware in a hood assembly including cable clamps, screws, etc.

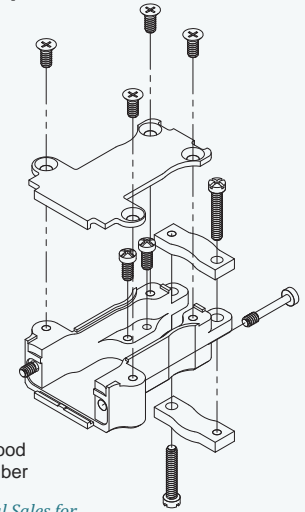

**NOTE:**

\*1 designates hood size in part number

Contact Technical Sales for weights on T2, E6, and E7 hardware options.

### LIGHTWEIGHT ALUMINUM CABLE ADAPTER (HOOD)

#### WITH FIXED FEMALE JACKSCREWS

CODE ANT2

Also available with Polarized Fixed Jackscrews. Contact Technical Sales for details.

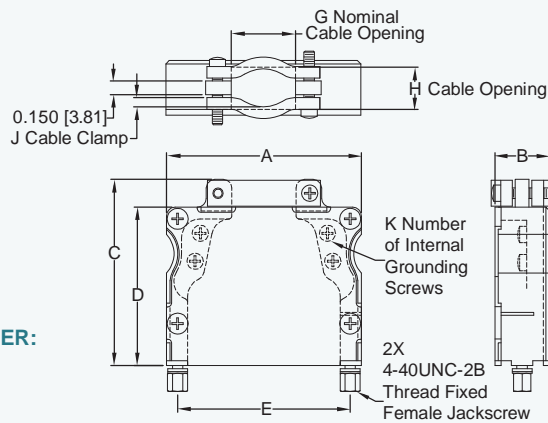

D15000ANT2G- Lightweight aluminum hood with fixed female jackscrews, pictured above with connector installed.

TYPICAL PART NUMBER:  
D25000ANT2G

SHELL SIZE	CONNECTOR / CONTACT VARIANT COMPATIBILITY		PART NUMBER	A	B	C	D	E	G	H		J	K
										Min.*2	Max.		
1	Std-D: 9 High-D: 15	Combo-D: 5W1, 2WK2 Combo-D High-D: 8W2	D9000ANT2G	1.219 [30.96]	0.586 [14.88]	2.000 [50.08]	1.700 [43.18]	0.984 [24.99]	0.362 [9.19]	0.240 [6.10]	0.453 [11.51]	0.050 [1.27]	4
2	Std-D: 15 High-D: 26	Combo-D: 3W3, 3WK3, 7W2, 11W1 Combo-D High-D: 19W1	D15000ANT2G	1.547 [39.29]	0.586 [14.88]	2.000 [50.08]	1.700 [43.18]	1.312 [33.32]	0.690 [17.53]	0.350 [8.89]	0.453 [11.51]	0.100 [2.54]	4
3	Std-D: 25 High-D: 44	Combo-D: 5W5, 9W4, 13W3, 17W2, 21W1 Combo-D High-D: 15W4	D25000ANT2G	2.094 [53.19]	0.586 [14.88]	2.000 [50.08]	1.700 [43.18]	1.852 [47.04]	0.690 [17.53]	0.350 [8.89]	0.453 [11.51]	0.100 [2.54]	4
4	Std-D: 37 High-D: 62	Combo-D: 8W8, 13W6, 17W5, 21WA4, 25W3, 27W2 Combo-D High-D: 45W2	D37000ANT2G	2.736 [69.49]	0.586 [14.88]	2.250 [57.15]	1.950 [49.53]	2.500 [63.50]	1.242 [31.55]	0.410 [10.41]	0.453 [11.51]	0.130 [3.30]	6
5	Std-D: 50 High-D: 78	Combo-D: 24W7, 36W4, 43W2, 47W1 Combo-D High-D: n/a	D50000ANT2G	2.642 [67.11]	0.689 [17.73]	2.250 [57.15]	1.950 [49.53]	2.406 [61.11]	1.242 [31.55]	0.410 [10.41]	0.564 [14.33]	0.130 [3.30]	6
6	Std-D: n/a High-D: 104	Combo-D: 46W4 Combo-D High-D: n/a	D104000ANT2G	2.736 [69.49]	0.760 [19.30]	2.250 [57.15]	1.950 [49.53]	2.500 [63.50]	1.242 [31.55]	0.410 [10.41]	0.627 [15.93]	0.130 [3.30]	6



LIGHTWEIGHT ALUMINUM CABLE ADAPTER (HOOD)  
WITH ROTATING JACKSCREWS  
CODE ANE, ANE6, AND ANE7

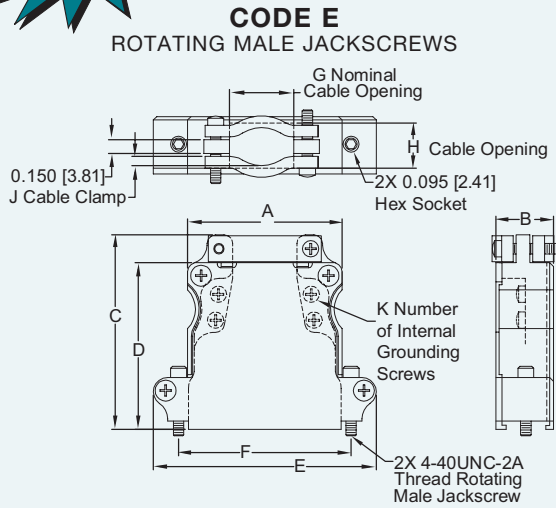

TYPICAL PART NUMBER: D25000ANEG

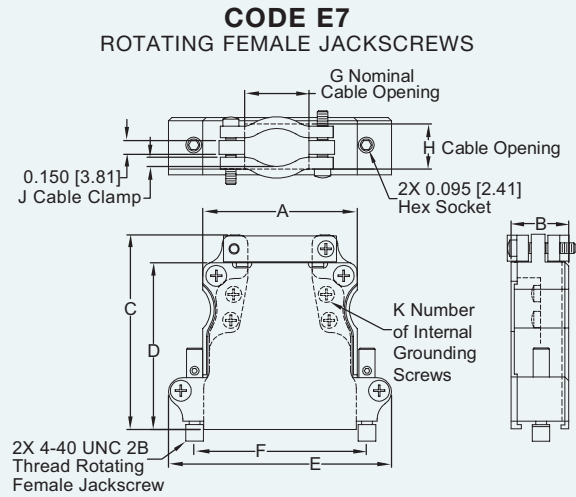

TYPICAL PART NUMBER: D25000ANE7G

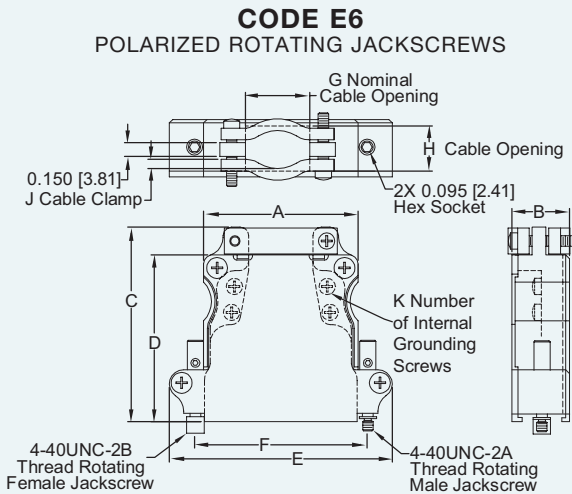

TYPICAL PART NUMBER: D25000ANE6G

*For Technical  
Characteristics,  
see page 91  
for details.*

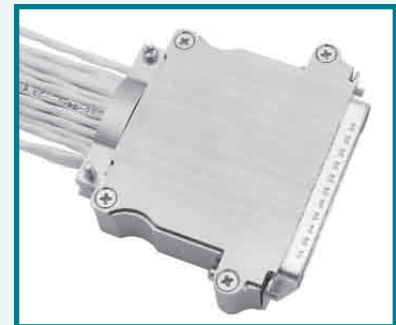

**D37000ANEG- Lightweight aluminum hood with rotating male jackscrews, pictured above with connector installed.**

SHELL SIZE	CONNECTOR / CONTACT VARIANT COMPATIBILITY		PART NUMBER	A	B	C	D	E	F	G	H		J	K
											Min. <sup>-2</sup>	Max.		
1	Std-D: 9 High-D: 15	Combo-D: 5W1, 2WK2 Combo-D High-D: 8W2	D9000AN*1G	0.908 [23.06]	0.616 [15.65]	2.090 [53.09]	1.790 [45.47]	1.524 [38.71]	0.984 [24.99]	0.362 [9.19]	0.240 [6.10]	0.483 [12.27]	0.050 [1.27]	4
2	Std-D: 15 High-D: 26	Combo-D: 3W3, 3WK3, 7W2, 11W1 Combo-D High-D: 19W1	D15000AN*1G	1.236 [31.39]	0.616 [15.65]	2.090 [53.09]	1.790 [45.47]	1.852 [47.04]	1.312 [33.32]	0.690 [17.53]	0.350 [8.89]	0.483 [12.27]	0.100 [2.54]	4
3	Std-D: 25 High-D: 44	Combo-D: 5W5, 9W4, 13W3, 17W2, 21W1 Combo-D High-D: 15W4	D25000AN*1G	1.656 [42.06]	0.616 [15.65]	2.090 [53.09]	1.790 [45.47]	2.392 [60.76]	1.852 [47.04]	0.690 [17.53]	0.350 [8.89]	0.483 [12.27]	0.100 [2.54]	4
4	Std-D: 37 High-D: 62	Combo-D: 8W8, 13W6, 17W5, 21WA4, 25W3, 27W2 Combo-D High-D: 45W2	D37000AN*1G	2.304 [58.52]	0.616 [15.65]	2.340 [59.44]	2.040 [51.82]	3.040 [77.22]	2.500 [63.50]	1.242 [31.55]	0.410 [10.41]	0.483 [12.27]	0.130 [3.30]	6
5	Std-D: 50 High-D: 78	Combo-D: 24W7, 36W4, 43W2, 47W1 Combo-D High-D: n/a	D50000AN*1G	2.210 [56.13]	0.727 [18.47]	2.340 [59.44]	2.040 [51.82]	2.946 [74.83]	2.406 [61.11]	1.242 [31.55]	0.410 [10.41]	0.594 [15.09]	0.130 [3.30]	6
6	Std-D: n/a High-D: 104	Combo-D: 46W4 Combo-D High-D: n/a	D104000AN*1G	2.304 [58.52]	0.790 [20.07]	2.340 [59.44]	2.040 [51.82]	3.040 [77.22]	2.500 [63.50]	1.242 [31.55]	0.410 [10.41]	0.657 [16.69]	0.130 [3.30]	6

NOTES: \*1 For completed part number, insert the desired code (E, E6 or E7) for required jackscrew option.  
\*2 Smaller cable openings may be achieved by inverting one or both cable clamps.

DIMENSIONS ARE IN INCHES [MILLIMETERS].  
ALL DIMENSIONS ARE SUBJECT TO CHANGE.



Positronic Industries  
connectpositronic.com

# ACCESSORIES

## MILITARY / SPACE FLIGHT QUALITY

High  
Performance  
D-sub

### EMI/RFI PROTECTIVE COVER

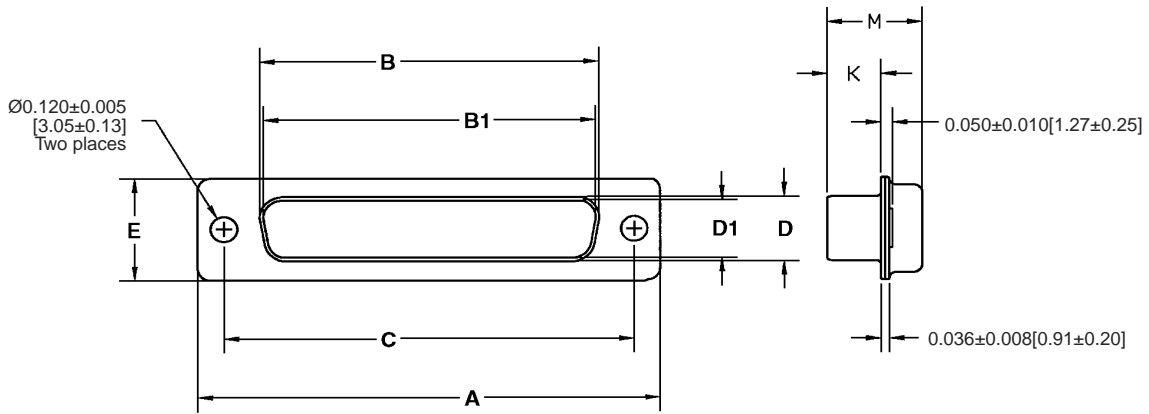

COVER PART NUMBER	COVER MATES TO	A $\pm 0.015$ [0.38]	B $\pm 0.005$ [0.13]	B1 $\pm 0.005$ [0.13]	C $\pm 0.005$ [0.13]	D $\pm 0.005$ [0.13]	D1 $\pm 0.005$ [0.13]	E $\pm 0.015$ [0.38]	K $\pm 0.005$ [0.13]	M $\pm 0.010$ [0.25]
PSK633-9MG*1	Female 9 / 15	1.213 [30.81]		0.666 [16.92]	0.984 [24.99]		0.329 [8.36]	0.494 [12.55]	0.233 [5.92]	0.422 [10.72]
PSK633-9FG*1	Male 9 / 15	1.213 [30.81]	0.643 [16.33]		0.984 [24.99]	0.311 [7.90]		0.494 [12.55]	0.243 [6.17]	0.429 [10.90]
PSK633-15MG*1	Female 15 / 26	1.541 [39.14]		0.994 [25.25]	1.312 [33.32]		0.329 [8.36]	0.494 [12.55]	0.233 [5.92]	0.422 [10.72]
PSK633-15FG*1	Male 15 / 26	1.541 [39.14]	0.971 [24.66]		1.312 [33.32]	0.311 [7.90]		0.494 [12.55]	0.243 [6.17]	0.429 [10.90]
PSK633-25MG*1	Female 25 / 44	2.088 [53.04]		1.534 [38.96]	1.852 [47.04]		0.329 [8.36]	0.494 [12.55]	0.230 [5.84]	0.426 [10.82]
PSK633-25FG*1	Male 25 / 44	2.088 [53.04]	1.511 [38.38]		1.852 [47.04]	0.311 [7.90]		0.494 [12.55]	0.243 [6.17]	0.429 [10.90]
PSK633-37MG*1	Female 37 / 62	2.729 [69.32]		2.182 [55.42]	2.500 [63.50]		0.329 [8.36]	0.494 [12.55]	0.230 [5.84]	0.426 [10.82]
PSK633-37FG*1	Male 37 / 62	2.729 [69.32]	2.159 [54.84]		2.500 [63.50]	0.311 [7.90]		0.494 [12.55]	0.243 [6.17]	0.429 [10.90]
PSK633-50MG*1	Female 50 / 78	2.635 [66.93]		2.079 [52.81]	2.406 [61.11]		0.441 [11.20]	0.605 [15.37]	0.230 [5.84]	0.426 [10.82]
PSK633-50FG*1	Male 50 / 78	2.635 [66.93]	2.064 [52.43]		2.406 [61.11]	0.423 [10.74]		0.605 [15.37]	0.243 [6.17]	0.429 [10.90]
PSK633-104MG*1	Female - / 104	2.729 [69.32]		2.212 [56.18]	2.500 [63.50]		0.503 [12.78]	0.668 [16.97]	0.230 [5.84]	0.426 [10.82]
PSK633-104FG*1	Male - / 104	2.729 [69.32]	2.189 [55.60]		2.500 [63.50]	0.485 [12.32]		0.668 [16.97]	0.243 [6.17]	0.429 [10.90]

Material: Brass, 0.000050 [1.27 μ] gold over copper.

**NOTE:**

\*1 To order protective cover with E2 rotating male screw locks (see page 94), insert "N" into the last digit of part number. Omit this digit if thread locks are not required.



SND25M1000G with PSK633-25FGN installed.



JACKSCREW SYSTEMS  
CODE T\*1, T2\*1, E, E2 AND E3

**Note:**  \*1 T or T2 jackscrew supplied on connectors in combination with other accessories may differ dimensionally, contact Technical Sales for more information.

CODE	A	B
T*1	0.437 [11.10]	0.250 [6.35]
T2*1	0.500 [12.70]	0.198 [5.03]

T\*1/T2\*1

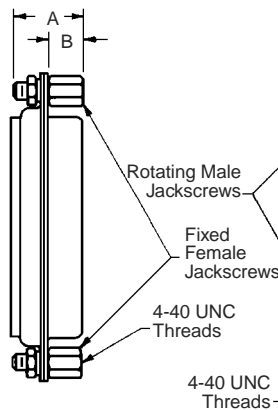

FIXED FEMALE JACKSCREWS

E/E3

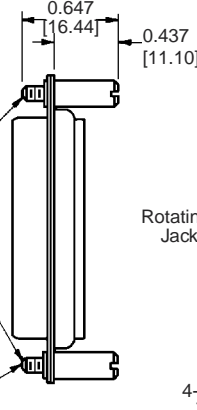

ROTATING MALE JACKSCREWS

E2

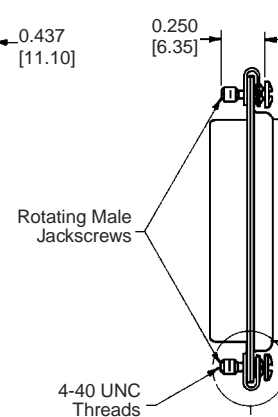

ROTATING MALE SCREW LOCKS

**Jackscrew Material:** Brass, 0.000050 inch [1.27 μ] gold over copper plate.

E = slotted for screw driver  
E3 = internal hex for 3/32 hex drives

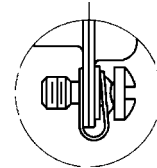

**Material: Screw** - Brass, 0.000050 inch [1.27 μ] gold over copper plate.

**U-Clip** - Copper alloy, 0.000050 inch [1.27 μ] gold over copper plate.

**NOTE:** Stainless steel jackscrews are available. Consult Technical Sales for ordering information.

POLARIZED JACKSCREW SYSTEMS  
CODE T6 AND E6

T6

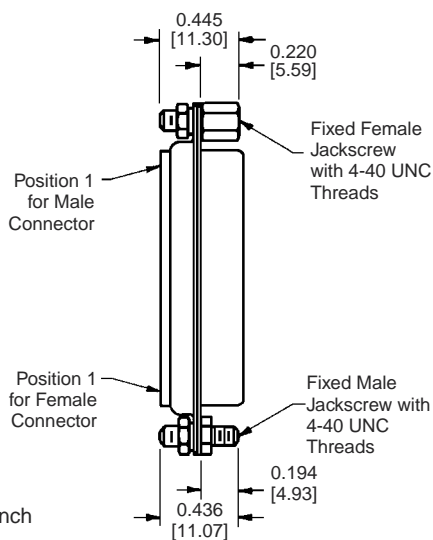

FIXED MALE AND FEMALE JACKSCREWS

E6\*2

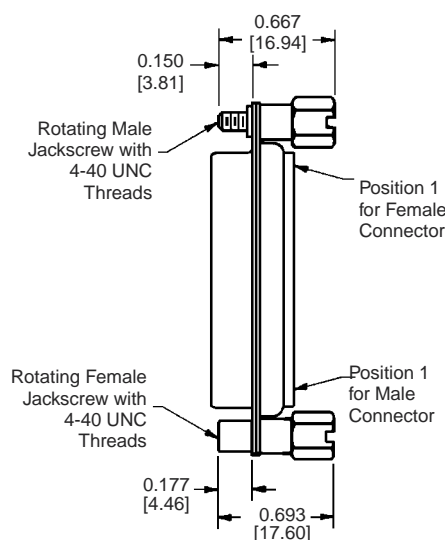

ROTATING MALE AND FEMALE JACKSCREWS

**Note:**  \*1 For customer installation of knobs onto jackscrews, set screw torque value of 16 in/oz is recommended. Recommend application of thread lock to set screw.

**Material:** Brass, 0.000050 inch [1.27 μ] gold over copper plate.

**Material:** Brass, 0.000050 inch [1.27 μ] gold over copper plate.



Positronic Industries  
connectpositronic.com



## SPECIAL OPTIONS MILITARY / SPACE FLIGHT QUALITY

High  
Performance  
D-sub

### MODIFICATION (MOS) SUFFIXES

Specify complete connector by selecting a base part number from the desired series **Ordering Information Page**.

Once base part number is selected, add desired modifications (MOS) number below to the end of the part number.

**Example part number:** SND9M5R7SNT2G-1768.33

*(Ordering information pages can be found at the end of each series)*

SERIES	CONNECTOR VARIANT	GENDER	TERMINATION TYPE AVAILABLE	MODIFICATION OF STANDARD (MOS) SUFFIXES	DESCRIPTION OF MODIFICATION
SND, SDD, SCBM, SCBC, SCBDD, SCBCD, SAD, SADD, SACBMP	ALL	MALE FEMALE	ALL	-54	Allows connector with contacts installed, for size 22, size 20 and size 16 contacts only to be plated 0.0000100 [2.54 μ] gold over copper.
SND, SDD, SCBM, SCBDD	ALL	MALE FEMALE	4, 5	-367.9	Allows connector to be supplied with contacts inverted.
SND, SDD, SCBC, SCBM, SCBDD, SCBCD	ALL	MALE FEMALE	ALL	-759.42	Allows connector to be supplied with blind mate guides, lockwashers and hexnuts installed. For connectors with a 4-40 threaded mounting style install blind mate guides only. For connectors with a R3/R6 mounting style install special blind mate guides with lockwashers and hexnuts. See page 90 in accessories section for more information.
SND, SDD, SCBM, SCBC, SCBDD, SCBCD, SAD, SADD	ALL	MALE FEMALE	ALL	-759.43	Allows connector, with any contacts to include blind mate mounting plate. See page 90 in accessories section for more information.
SND, SDD, SCBC, SCBM, SCBDD, SCBCD	ALL	MALE FEMALE	ALL	-1144.8	Allows connector to have Group A inspection per Goddard Spec GSFC-S-311-P-4 performed. Certifications included with shipment.
SCBM	3W3, 8W8	MALE FEMALE	0	-1570.4	Integral stabilizing feature used to minimize size 8 contacts from floating in the molding. Use tool number 4311-0-1-0 to removed contact if necessary. See page 74 in unique feature section for more information.
SCBC	36W4, 43W3				
SND, SDD	ALL	MALE FEMALE	ALL	-1768.33	Allows connector to be permanently marked with single lot/date code. Individual package and label per MIL-C-5530. Inspect per GSFC-S-311-P-4. Failure analysis reports. Certifications included with shipment.

**MANY OTHER SPECIAL OPTIONS ARE AVAILABLE CONSULT TECHNICAL SALES  
OR VISIT OUR WEB SITE AT WWW.CONNECTPOSITRONIC.COM**

# Connectors Designed To Customer Specifications

*Positronic High Performance D-subminiature connectors can be modified to customers specifications.*

**Examples:** select loading of contacts for cost savings or to gain creepage and clearance distances; longer PCB terminations; customer specified hardware; sealing for water resistance.

***Contact Technical Sales with your particular requirements.***



## APPLICATION TOOLS SECTION

High Performance D-subminiature connectors are offered with **removable crimp contacts**.

Positronic Industries recognizes the **importance of supplying application tooling** to support our customers' use of our products.

Information on application tooling is **available** on our web site at

<http://www.connectpositronic.com/products/157/ApplicationTooling>

There you will find **downloadable PDF** cross reference charts for removable contacts. These charts will **supply part numbers** for insertion, removal and crimping tools, along with **information regarding use** of tools and techniques.



## Do you need 2-D drawings or 3-D models?

Once you have made a connector selection, contact Technical Sales if you would like a 2-D drawing or 3-D model. If we do not have your specific part number on file, we can create one for you. Or, please visit [www.connectpositronic.com](http://www.connectpositronic.com) and use the search function.

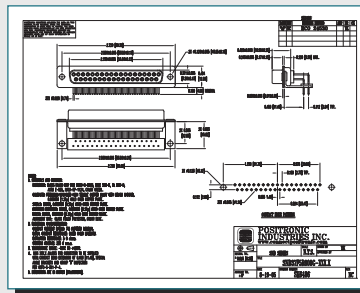

2-D Drawing

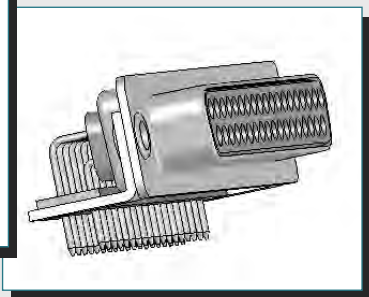

3-D Model







# Positronic® offers a variety of QPL connector products

## D-SUBMINIATURE CONNECTORS

MIL PREFIX	POSITRONIC SERIES
MIL-DTL-24308/1	HDC
MIL-DTL-24308/2	RD, DD
MIL-DTL-24308/3	HDC
MIL-DTL-24308/4	RD, DD
MIL-DTL-24308/5	HDC
MIL-DTL-24308/6	RD, DD
MIL-DTL-24308/7	HDC
MIL-DTL-24308/8	RD, DD
MIL-DTL-24308/23	HDC, DD

MIL PREFIX	POSITRONIC SERIES
MIL-DTL-24308/24	HDC, DD
MIL-DTL-24308/25	HDC, RD, DD
MIL-DTL-24308/26	HDC, RD, DD
GSFC S-311-P4	SND, SDD, SCBC, SCBM
GSFC S-311-P10	SND, SCBM
SAE AS39029/57	DD
SAE AS39029/58	DD
SAE AS39029/63	RD
SAE AS39029/64	RD

## RECTANGULAR CONNECTORS

MIL PREFIX	POSITRONIC SERIES
MIL-DTL-28748/3	GMCT
MIL-DTL-28748/4	GMCT
MIL-DTL-28748/5	GM
MIL-DTL-28748/6	GM
MIL-DTL-28748/7	SGM

MIL PREFIX	POSITRONIC SERIES
MIL-DTL-28748/8	SGM
MIL-C-28748/13	SGMC
MIL-C-28748/14	SGMC
SAE AS39029/34	SGMC, GMCT
SAE AS39029/35	SGMC, GMCT

For a complete QPL listing available to download in PDF format, visit the desired connector family home page and click on link "Qualified Product Listing (PDF)" on our website at:

[www.connectpositronic.com](http://www.connectpositronic.com)

or enter the URL link below to download the QPL PDF file immediately!

[http://www.connectpositronic.com/pdf\\_view/222/](http://www.connectpositronic.com/pdf_view/222/)

# Positronic Hermetic Connector Assemblies



- **Leakage Rate:  $5 \times 10^{-9}$  mbar.l/s @ vacuum  $1.5 \times 10^{-5}$  atm**
- **Shock and vibration resistant**
- **Application Specific Design**

Positronic Industries can supply hermetic connector assemblies for use in vacuum applications. All Positronic hermetic connectors are designed to act as feedthroughs through the bulkhead/chamber wall. Typically both sides of the connector have mating faces, but certain contact terminations are also available per customer requirement. Typical configurations include:

- **Standard Density D-subminiature** (Contact size 20)
- **High Density D-subminiature** (Contact size 22)
- **Mixed Density D-subminiature** (Contact sizes 8 and 20 in a single package)
- **Circular** (Variety of contact sizes and configurations)

In addition to simply providing the hermetic connector itself, Positronic can provide a fully-assembled flange/plate according to customer specification (see above).

**For more information on Positronic hermetic capabilities**, please call (800) 641-4054 and request to speak to someone about the Positronic hermetic product line.

# Connector Excellence<sup>®</sup>

## Positronic HIGH RELIABILITY Products

### POWER



#### FEATURES:

- High current density
- Energy saving - low contact resistance
- AC/DC operation in a single connector
- Signal contacts for hardware management
- Blind mating
- Sequential mating
- Large surface area contact mating system
- Wide variety of accessories
- Customer-specified contact arrangements
- Modular tooling which produces a single piece connector insert

**Contact Sizes:** 0, 8, 12, 16, 20, 22 and 24  
To 200 amperes per contact

**Current Ratings:** Crimp and panel mount, straight solder, right angle (90°) solder, straight compliant press-in and right angle (90°) compliant press-in

**Terminations:** Multiple variants in a variety of package sizes

**Configurations:** MIL-DTL-24308, GSFC S-311-P-4, DSCC, GSFC S-311-P-10, PICMG 2.11, PICMG 3.0, VITA 41, DSCC, GSFC S-311-P-4, GSFC S-311-P-10

**Compliance:**

### D - SUB MINIATURE



#### FEATURES:

- Four performance levels available for best cost/performance ratio: professional, industrial, military and space-flight quality
- Options include high voltage, coax, thermocouple and air coupling contacts; environmentally sealed and dual port connector packages including mixed density
- Broad selection of accessories
- Size 20 and 22 contacts suitable for use in carrying power
- IP65, IP67

**Contact Sizes:** 8, 16, 20 and 22  
To 100 amperes

**Current Ratings:** Crimp, wire solder, straight solder, right angle (90°) solder, straight compliant press-in and right angle (90°) compliant press-in

**Terminations:** Multiple variants in both standard and high densities, seven shell sizes

**Configurations:** MIL-DTL-24308, GSFC S-311-P-4, GSFC S-311-P-10, SAE AS39029, DSCC

**Qualifications:**

### RECTANGULAR



#### FEATURES:

- Two performance levels available: industrial quality and military quality
- A wide variety of accessories
- Broad selection of contact variants and package sizes
- Connector keying options

**Contact Sizes:** 16, 20 and 22

**Current Ratings:** To 13 amperes nominal

**Terminations:** Crimp, wire solder, straight solder, right angle (90°) solder, and straight compliant press-in

**Configurations:** Multiple variants in both standard and high densities, thirty package sizes

**Qualifications:** MIL-DTL-28748, SAE AS39029, CCITT V.35

### CIRCULAR



#### FEATURES:

- Non-corrodible / lightweight composite construction
- EMI/RFI shielded versions
- Thermocouple contacts
- Environmentally sealed versions
- Rear insertion/ front release of removable contacts
- Two level sequential mating
- Overmolding available on full assemblies

**Contact Sizes:** 12, 16, 20 and 22  
To 25 amperes nominal

**Current Ratings:** Crimp, wire solder, straight solder, and right angle (90°) solder

**Terminations:** Multiple variants in four package sizes

**Configurations:** Environmental protection to IP67

**Qualifications:**

### CABLE



#### FEATURES:

- Shorten the supply chain and reduce additional costs and delays by "cabling" your Positronic connector selection
- Overmolding available
- Shielded and environmentally sealed versions available
- Power cables and access boxes which meet the SAE J2496 specification

- ✓ Design assemblies in accordance with customer specifications.
- ✓ Prepare cabled connector configuration and performance specifications.
- ✓ Design each system in accordance with applicable customer, domestic, and international standards.
- ✓ Define and conduct performance and verification testing.

### HERMETIC



#### FEATURES:

- Intended for use as an electrical feedthrough in high vacuum applications
- Leakage rate: 5 x 10<sup>-9</sup> mbar.l/s @ vacuum 1.5 x 10<sup>-5</sup> atm
- Signal, power, coax and high voltage versions available
- Connectors can be mounted on flange assembly per customer specification

**Contact Sizes:** 8, 12, 16, 20 and 22

**Current Ratings:** To 40 amperes nominal

**Terminations:** Feedthrough is standard; flying leads and board mount available upon request

**Configurations:** See D-subminiature and circular configurations above

**Compliance:** Space-D32

For more information, visit [www.connectpositronic.com](http://www.connectpositronic.com) or call your nearest Positronic sales office listed on the back of this catalog.

## **NORTH AMERICAN LOCATIONS**

### **UNITED STATES, Springfield, Missouri, Corporate Headquarters**

Factory Sales and Engineering Offices 800 641 4054 info@connectpositronic.com

### **PUERTO RICO, Ponce Factory**

Factory Sales and Engineering Offices 800 641 4054 info@connectpositronic.com

### **MEXICO**

Factory Sales and Engineering Offices 800 872 7674 info@connectpositronic.com

### **CANADA**

Factory Sales and Engineering Offices 800 327 8272 info@connectpositronic.com

## **ASIA/PACIFIC LOCATIONS**

### **SINGAPORE, Asia/Pacific Headquarters**

Factory Sales and Engineering Offices 65 6842 1419 singapore@connectpositronic.com

### **ASIA, Direct Sales Offices**

China -Zhuhai Factory and Sales Office	86 756 3626 466	zhuhai@connectpositronic.com
China -Shenzhen Sales Office	86 755 2643 7578	shenzhen@connectpositronic.com
China -Shanghai Sales Office	86 158 2907 9779	shanghai@connectpositronic.com
China -Xian/Beijing Sales Office	86 29 8839 5306	xian@connectpositronic.com
Korea Sales Office	82 31 909 8047	korea@connectpositronic.com
Taiwan Sales Office	886 2 2937 8775	taiwan@connectpositronic.com

### **JAPAN, Direct Sales Offices**

Sales and Engineering Offices 81 3 5619 8072 japan@connectpositronic.com

### **INDIA, Direct Sales Offices**

Factory Sales and Engineering Offices	91 20 2439 4810	india@connectpositronic.com
Bangalore Sales Office	91 94 4907 3251	bangalore@connectpositronic.com
New Delhi Sales Office	91 80 1071 1175	delhi@connectpositronic.com

### **ASIA/PACIFIC, Technical Agents**

Technical Agents in Malaysia, Australia, New Zealand, Philippines, Hong Kong, Vietnam, Thailand

## **EUROPEAN LOCATIONS**

### **FRANCE, Auch Factory, European Headquarters**

Factory Sales and Engineering Offices 33 5 6263 4491 contact@connectpositronic.com

### **EUROPE, Direct Sales Offices**

Northern France Sales Office	33 1 4588 1388	jchalaux@connectpositronic.com
Southern France Sales Office	33 5 6263 4491	plafon@connectpositronic.com
Eire + Northern Ireland	33 5 6263 4557	tauvin@connectpositronic.com
Italy Sales Office	39 02 5411 6106	rmagni@connectpositronic.com
Germany Sales Office	49 23 5163 4739	cbouche@connectpositronic.com
UK Sales Office	44 7975 682 488	lbridwell@connectpositronic.com

### **EUROPE, Technical Agents**

Technical Agents in Austria, Benelux, Eastern Europe Countries, Greece, Ireland, Russia, Scandinavia, Spain, Switzerland and the United Kingdom

### **MIDEAST, Technical Agents**

Technical Agents in Israel and Turkey



**POSITRONIC**  
GLOBAL *Connector* SOLUTIONS

### **POSITRONIC INDUSTRIES, INC.**

423 N Campbell Avenue • PO Box 8247 • Springfield, MO 65801  
Tel 417 866 2322 • Fax 417 866 4115 • Toll Free 800 641 4054  
info@connectpositronic.com

### **POSITRONIC INDUSTRIES, S.A.S.**

Zone Industrielle d'Engachies • 46 Route d'Engachies  
France 32020 Auch Cedex 9  
Telephone 33 5 6263 4491 • Fax 33 5 6263 5117  
contact@connectpositronic.com

### **POSITRONIC ASIA PTE LTD.**

3014A Ubi Road 1 #07-01 • Singapore 408703  
Telephone 65 6842 1419 • Fax 65 6842 1421  
singapore@connectpositronic.com

CONNECT POSITRONICS