

"Schutzvermerk nach DIN ISO 16016 beachten." "Please pay attention to copyright note DIN ISO 16016"

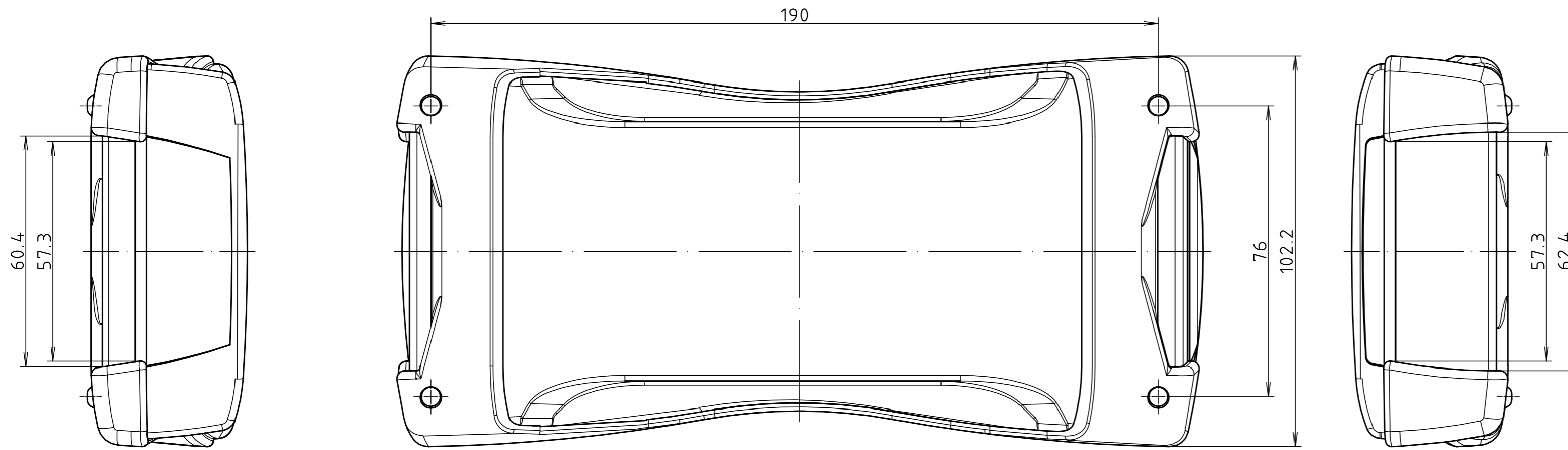

BS 800 mit DI-D  
parallel montiert  
BS 800 with Di-D  
parallel assembled

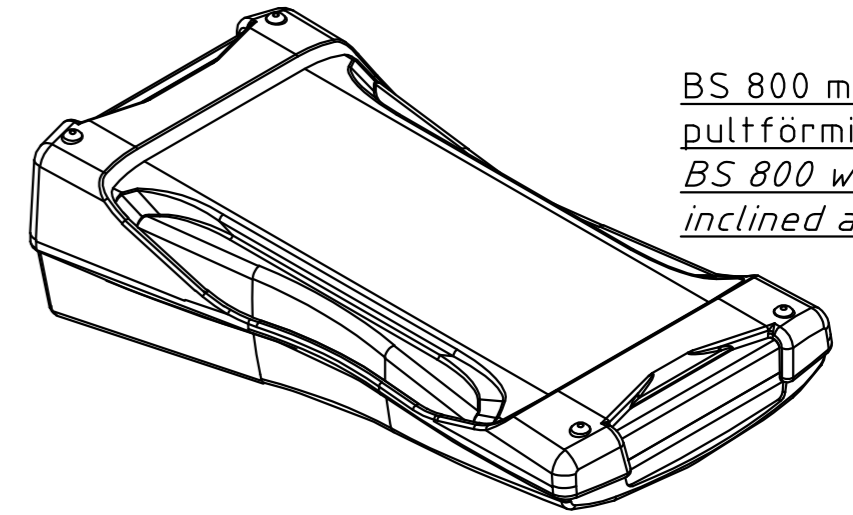
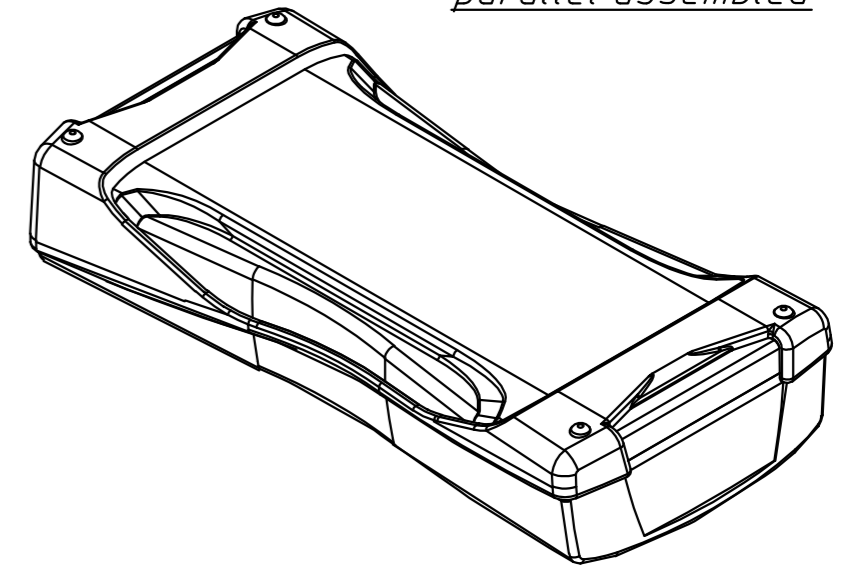

BS 800 mit DI-D  
pultförmig montiert  
BS 800 with Di-D  
inclined assembled

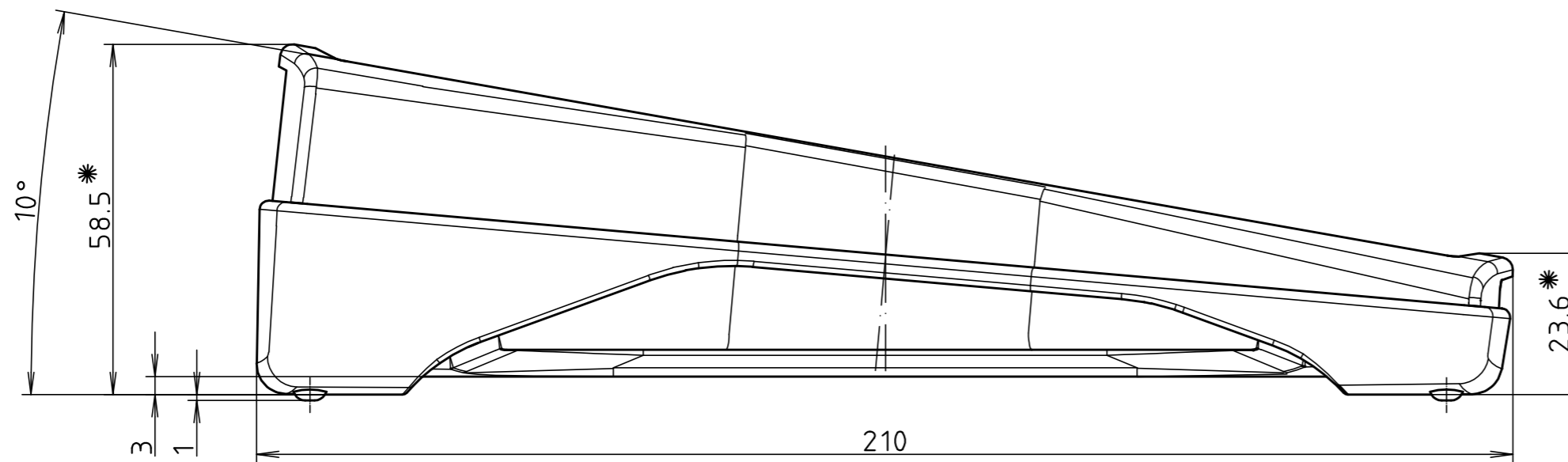
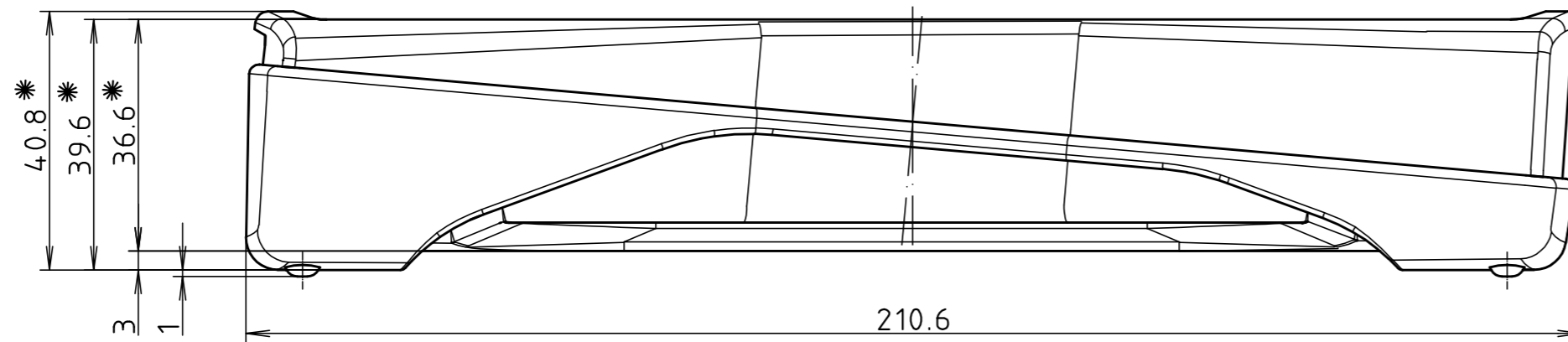

BS 800 DI-D

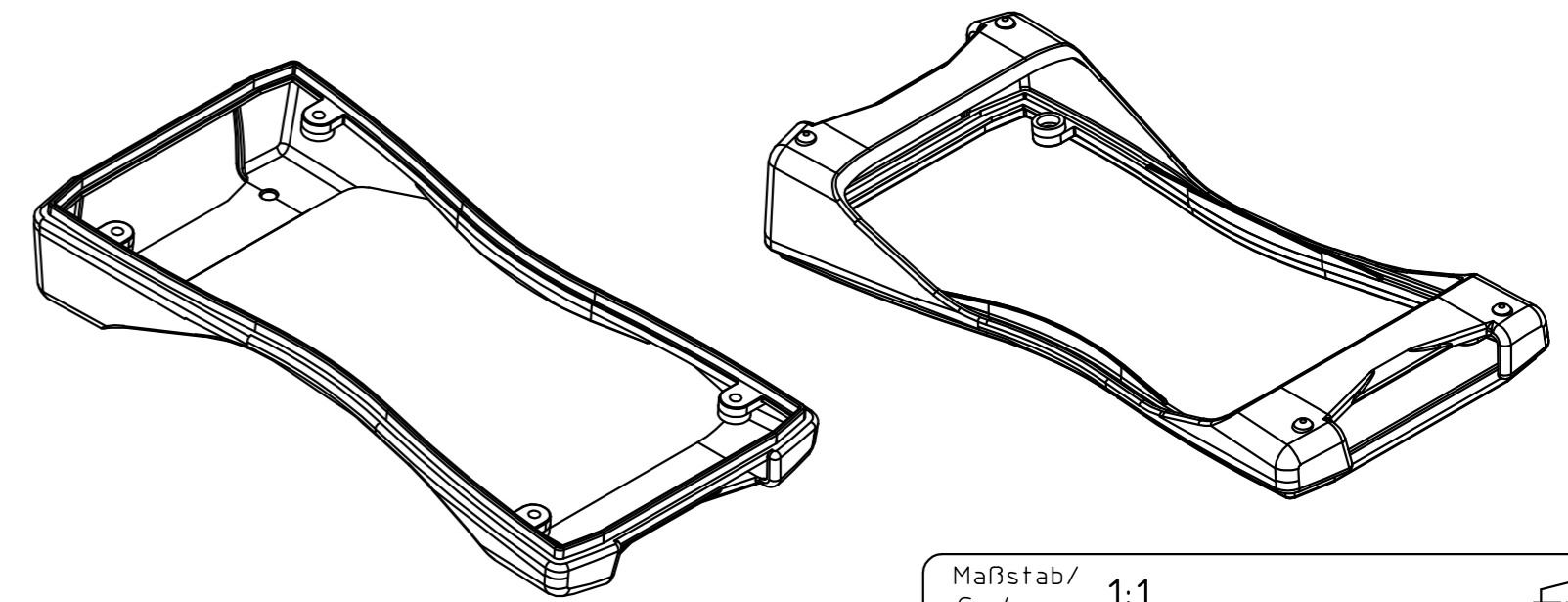

\* Je nach Anzugsmoment verringern sich die Maße um bis zu 0.5mm.  
The dimensions reduce up to 0.5mm depend by the torque

Maßstab/ Scale: 1:1

Zeichnungs-Nr. / Drawing-No.: 2K 5355.042.01

Artikel / Article: BS 800 DI-D  
Katalogzeichnung / Catalogue drawing

A.Nr. / Alt-No.:  
Datum / Date:  
DISK: 2 802 693  
Datum / Date: 09.06.06 KH

