

PCM 150/75 T



Sample image

Order symbol: PCM 150/75 T

Product nbr: 6016914

UL Code: 6416914

UL Name: UL PCM 150/75 T

Description: Enclosure. PC

Remarks: Smoked transparent cover

Including: Base with TPE gasket, screws for mounting plate/DIN-rail and cover with polyamide cover screws.

EAN: 6418074038258

El. number:

- Finland: 3421666
- Denmark: 8212027174
- Sweden: 2535427

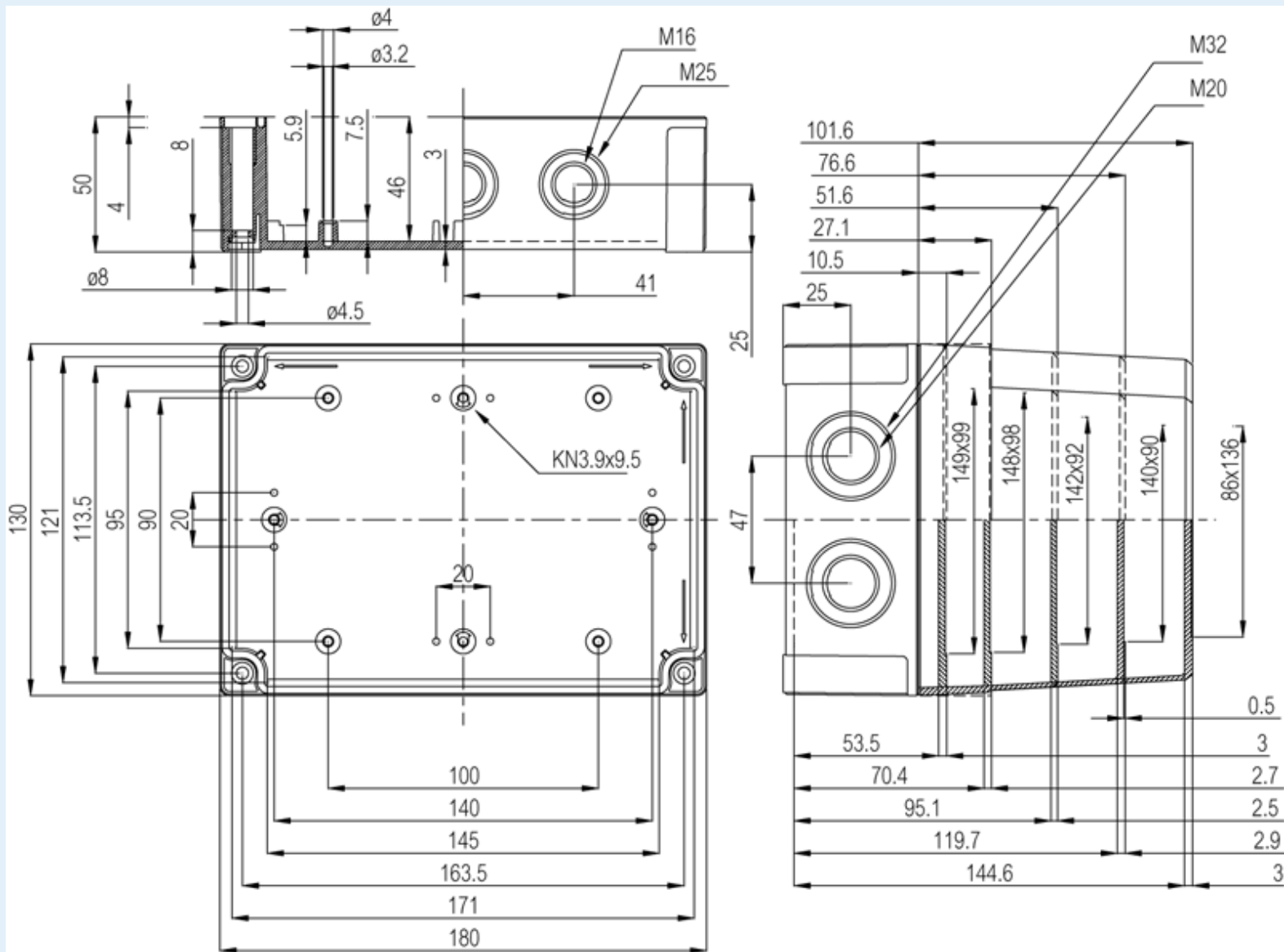

Dimensions:	Height	Width	Depth
mm:	180	130	75
inch:	7.09	5.12	2.95

Materials:

Material:	Polycarbonate
Base colour:	RAL 7035 -light grey
Cover colour:	Clear transparent
Gasket material:	Polyurethane

Temperatures:

Temperature °C (short term)::	-40 ... 120
Temperature °C (continuous):	-40 ... 80
Temperature °F (short term):	-40 ... 250
Temperature °F (continuous):	-40 ... 175

Accessories:

MIV 10	DIN-35 Mounting rail. for enclosures: (100 x 35 x 1)
FP A 150/180	Front panel (Aluminum). for enclosures: (170 x 112 x 1)
HFP 180	Front panel hinge series
MIV 150	Back Panel (Galvanized steel). for enclosures: (148 x 98 x 1)
MIN 15	DIN-15 Mounting rail. for enclosures: (150 x 15 x 1)
MIN 10	DIN-15 Mounting rail. for enclosures: (100 x 15 x 1)
MIV 15	DIN-35 Mounting rail. for enclosures: (150 x 35 x 1)
FP 22046	Mounting foot kit (4 pcs)

Rating:

Ingress protection (EN 60529):	IP66; IP67;
Impact Resistance (EN 62262):	IK08;
Electrical insulation:	Totally insulated

Halogen free (DIN/VDE 0472, Part 815):	1
UV resistance:	UL 508
Flammability Rating:	UL 746C 5"
Glow Wire Test (IEC 695-2-1) °C:	960 °C
NEMA Class	

Certificates:

Certificate FI 40847