

OSRAM GF CSSRML.24

Datasheet

Published by **ams-OSRAM AG**

Tobelbader Strasse 30, 8141 Premstaetten, Austria

Phone +43 3136 500-0

ams-osram.com

© All rights reserved



OSLON® Optimal

GF CSSRML.24

A brand new family of LEDs with our ams OSRAM's latest chip technology, delivering significant performance upgrades. Offered in four colors for ease of design and flexibility for all your horticulture spectrum needs. With Hyper Red (660 nm), Deep Blue (450 nm), Far Red (730 nm) and Horti White options to select from both narrow spectrum and full spectrum solutions can be designed to meet all crop needs for both greenhouses and vertical farms.

The OSLON® Optimal strikes a perfect balance of performance and cost along with proven robustness, high reliability and long lifetime.

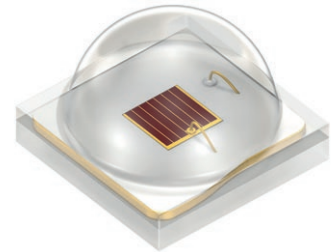

Applications

- Architecture

- Horticulture Lighting

Features

- Package: SMT ceramic package with silicone lens
- Typ. Radiation: 120° (Lambertian emitter)
- ESD: 8 kV acc. to ANSI/ESDA/JEDEC JS-001 (HBM, Class 3B)
- Radiant Flux: typ. 440 mW
- Radiant Efficiency: typ. 64.5%
- Photon Flux: typ. 2.69 umol/s
- Photon Flux Efficacy: typ. 3.94 umol/J

Ordering Information

| Type | Total radiant flux ¹⁾ $I_F = 350 \text{ mA}$ Φ_E | Ordering Code |
|-----------------------|--|---------------|
| GF CSSRML.24-TNUL-1-1 | 380 ... 565 mW | Q65113A4445 |

Maximum Ratings

| Parameter | Symbol | | Values |
|--|-----------|------|------------------------------------|
| Operating Temperature | T_{op} | min. | -40 °C |
| | | max. | 125 °C |
| Storage Temperature | T_{stg} | min. | -40 °C |
| | | max. | 125 °C |
| Junction Temperature | T_j | max. | 135 °C |
| Forward current | I_F | min. | 30 mA |
| | | max. | 1000 mA |
| Surge Current $t \leq 10 \mu s$; $D = 0.005$; $T_j = 25 \text{ °C}$ | I_{FS} | max. | 2000 mA |
| Reverse voltage ²⁾ | V_R | | Not designed for reverse operation |
| ESD withstand voltage acc. to ANSI/ESDA/JEDEC JS-001 (HBM, Class 3B) | V_{ESD} | | 8 kV |

Characteristics

$I_F = 350 \text{ mA}$; $T_J = 25 \text{ °C}$

| Parameter | Symbol | | Values |
|--|-----------------------------|----------------------|--|
| Peak Wavelength | λ_{peak} | typ. | 730 nm |
| Centroid Wavelength ³⁾ $I_F = 350 \text{ mA}$ | $\lambda_{\text{centroid}}$ | min. typ. max. | 710 nm 727 nm 740 nm |
| Spectral Bandwidth at 50% $I_{\text{rel,max}}$ | $\Delta\lambda$ | typ. | 30 nm |
| Viewing angle at 50% I_V | 2ϕ | typ. | 120 ° |
| Forward Voltage ⁴⁾ $I_F = 350 \text{ mA}$ | V_F | min. typ. max. | 1.80 V 1.95 V 2.20 V |
| Reverse current ²⁾ | I_R | | Not designed for reverse operation |
| Electrical thermal resistance junction/solderpoint with efficiency $\eta_e = 64.5 \%$ | $R_{\text{thJS elec.}}$ | typ. | 2.0 K / W |

Brightness Groups

| Group | Total radiant flux ¹⁾ $I_F = 350 \text{ mA}$ min. Φ_E | Total radiant flux ¹⁾ $I_F = 350 \text{ mA}$ max. Φ_E | PPF * min. Φ_p | PPF * max. Φ_p | PPF/W * typ. | PF ** min. $\Phi_{p,b}$ | PF ** max. $\Phi_{p,b}$ | PF/W ** typ. |
|-------|--|--|----------------------------|----------------------------|---------------------------|-------------------------------|-------------------------------|---------------------------|
| TN | 380 mW | 415 mW | 0.098 $\mu\text{mol/s}$ | 0.107 $\mu\text{mol/s}$ | 0.15 $\mu\text{mol/J}$ | 2.32 $\mu\text{mol/s}$ | 2.54 $\mu\text{mol/s}$ | 3.56 $\mu\text{mol/J}$ |
| TO | 415 mW | 450 mW | 0.107 $\mu\text{mol/s}$ | 0.116 $\mu\text{mol/s}$ | 0.16 $\mu\text{mol/J}$ | 2.54 $\mu\text{mol/s}$ | 2.75 $\mu\text{mol/s}$ | 3.88 $\mu\text{mol/J}$ |
| UJ | 450 mW | 485 mW | 0.116 $\mu\text{mol/s}$ | 0.125 $\mu\text{mol/s}$ | 0.18 $\mu\text{mol/J}$ | 2.75 $\mu\text{mol/s}$ | 2.97 $\mu\text{mol/s}$ | 4.19 $\mu\text{mol/J}$ |
| UK | 485 mW | 525 mW | 0.125 $\mu\text{mol/s}$ | 0.135 $\mu\text{mol/s}$ | 0.19 $\mu\text{mol/J}$ | 2.97 $\mu\text{mol/s}$ | 3.21 $\mu\text{mol/s}$ | 4.53 $\mu\text{mol/J}$ |
| UL | 525 mW | 565 mW | 0.135 $\mu\text{mol/s}$ | 0.145 $\mu\text{mol/s}$ | 0.21 $\mu\text{mol/J}$ | 3.21 $\mu\text{mol/s}$ | 3.46 $\mu\text{mol/s}$ | 4.89 $\mu\text{mol/J}$ |

Note: [*] Photosynthetic Photon Flux includes wavelengths between 400 and 700 nm
 Note: [**] Photon Flux includes wavelengths between 280 and 800 nm
 Note: PPF and PF values are for reference only

Forward Voltage Groups

| Group | Forward Voltage ⁴⁾ $I_F = 350 \text{ mA}$ min. V_F | Forward Voltage ⁴⁾ $I_F = 350 \text{ mA}$ max. V_F |
|-------|--|--|
| E1 | 1.80 V | 1.90 V |
| E2 | 1.90 V | 2.00 V |
| F1 | 2.00 V | 2.10 V |
| F2 | 2.10 V | 2.20 V |

Centroid Wavelength

| Group | Centroid Wavelength ³⁾ $I_F = 350 \text{ mA}$ min. $\lambda_{\text{centroid}}$ | Centroid Wavelength ³⁾ $I_F = 350 \text{ mA}$ max. $\lambda_{\text{centroid}}$ |
|-------|--|--|
| 1 | 710 nm | 740 nm |

Group Name on Label

Example: TN-1-E1

| Brightness | Wavelength | Forward Voltage |
|------------|------------|-----------------|
| TN | 1 | E1 |

Relative Spectral Emission ⁵⁾

$I_{rel} = f(\lambda)$; $I_F = 350 \text{ mA}$; $T_J = 25 \text{ }^\circ\text{C}$

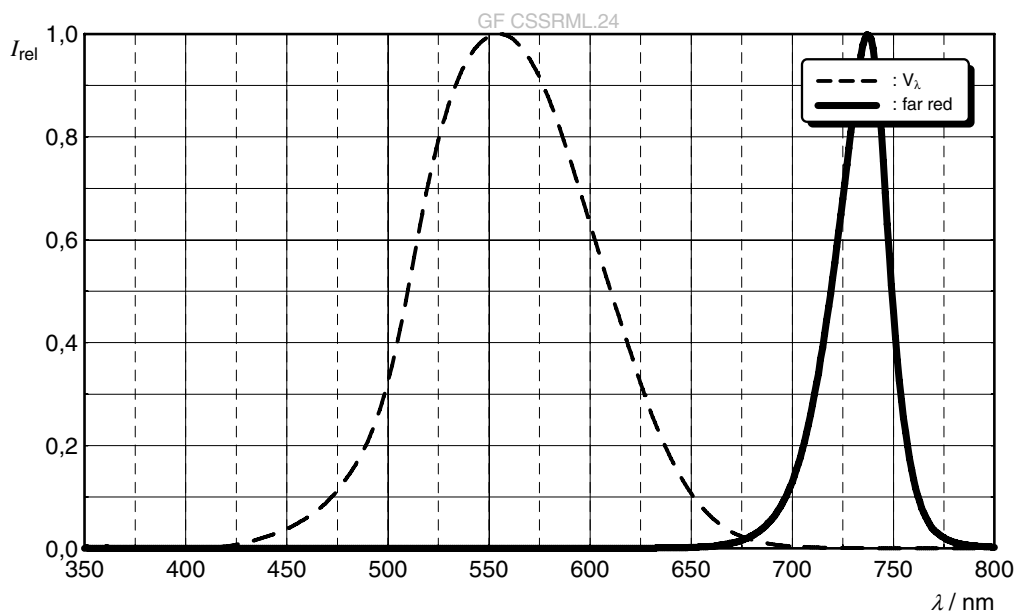

Radiation Characteristics ⁵⁾

$I_{rel} = f(\phi)$; $T_J = 25 \text{ }^\circ\text{C}$

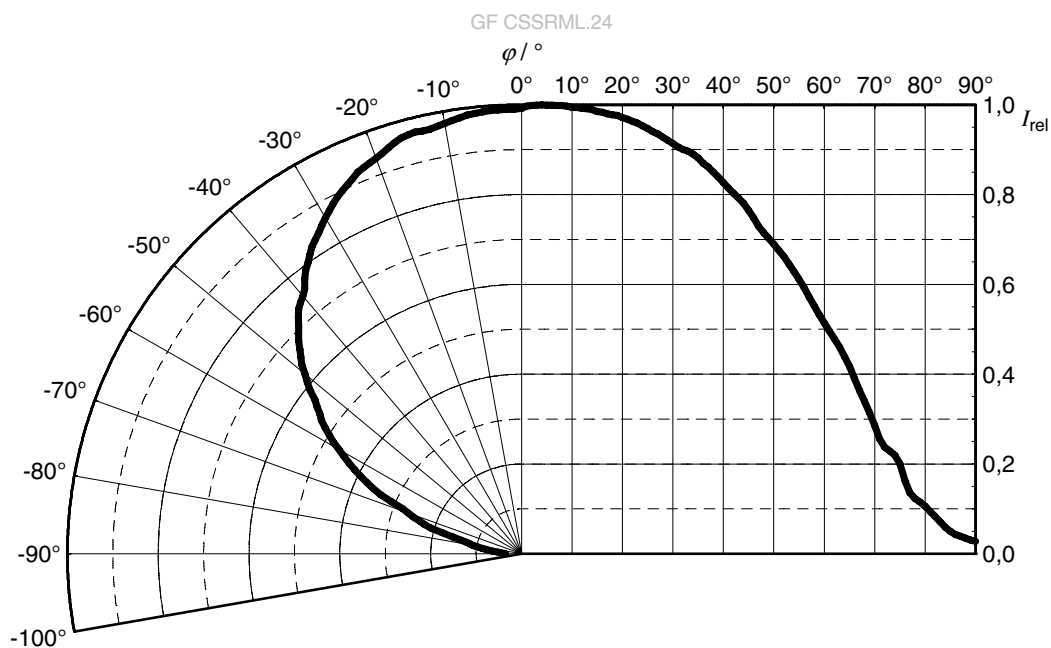

Forward current ⁵⁾

$$I_F = f(V_F); T_J = 25\text{ °C}$$

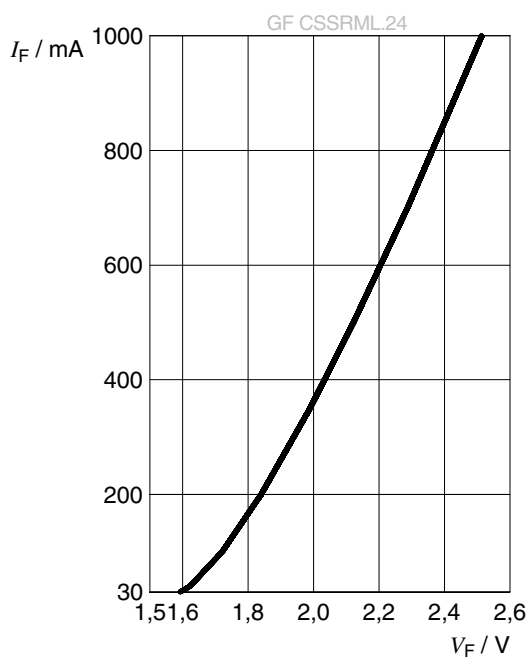

Relative Radiant Power ^{5), 6)}

$$\Phi_E / \Phi_E(350\text{ mA}) = f(I_F); T_J = 25\text{ °C}$$

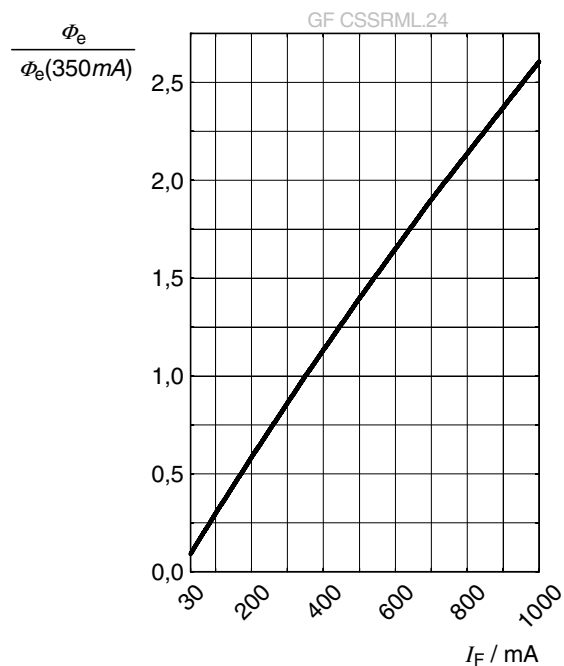

Forward Voltage ⁵⁾

$$\Delta V_F = V_F - V_F(25\text{ °C}) = f(T_j); I_F = 350\text{ mA}$$

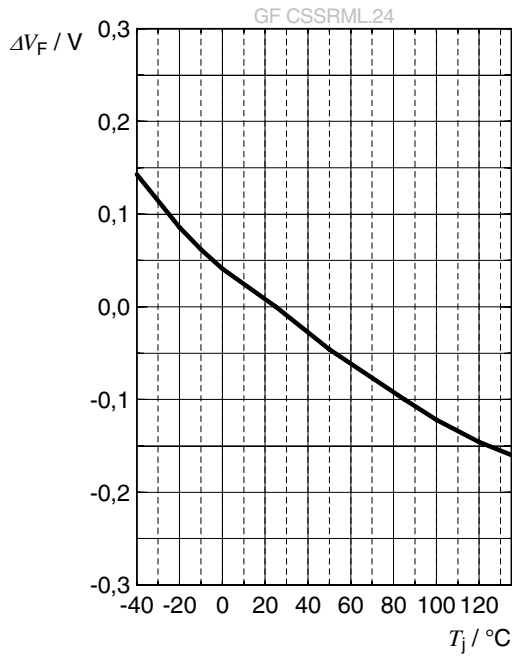

Relative Radiant Power ⁵⁾

$$\Phi_E / \Phi_E(25\text{ °C}) = f(T_j); I_F = 350\text{ mA}$$

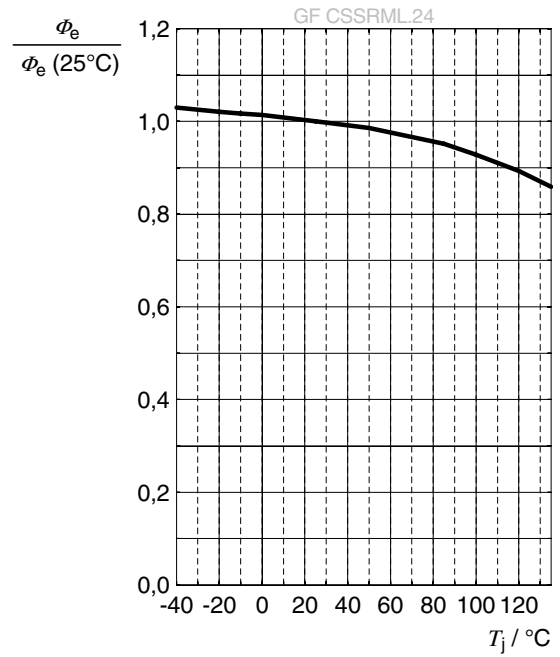

Centroid Wavelength ⁵⁾

$$\Delta \lambda_{\text{centr}} = \lambda_{\text{centr}} - \lambda_{\text{centr}}(25\text{ °C}) = f(T_j); I_F = 350\text{ mA}$$

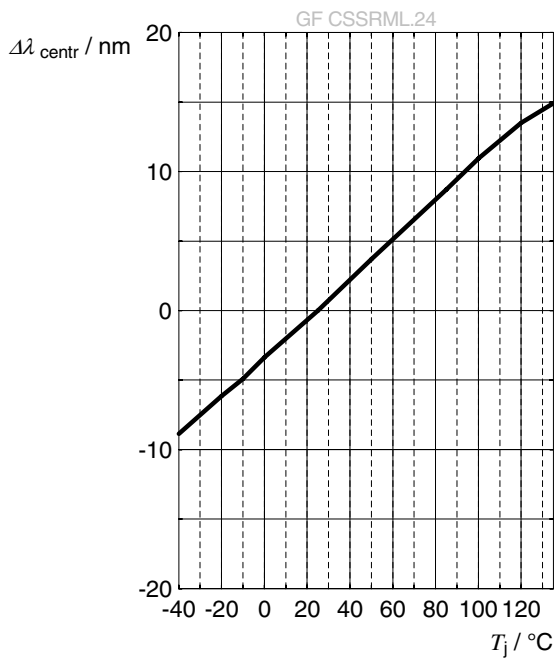

Max. Permissible Forward Current

$$I_F = f(T)$$

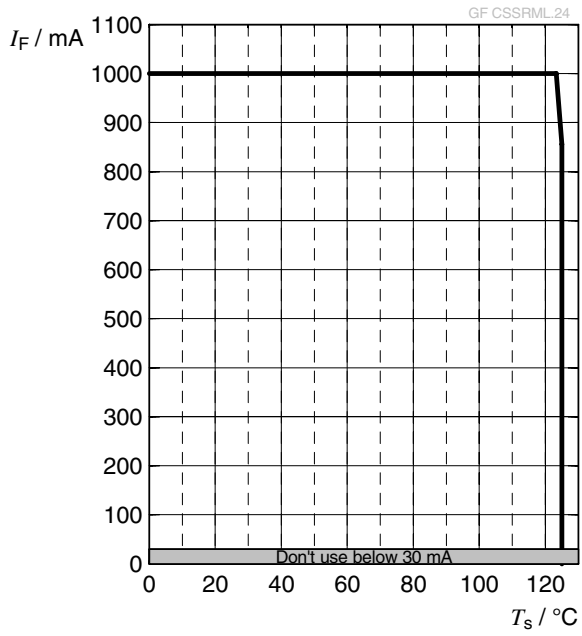

Dimensional Drawing ⁷⁾

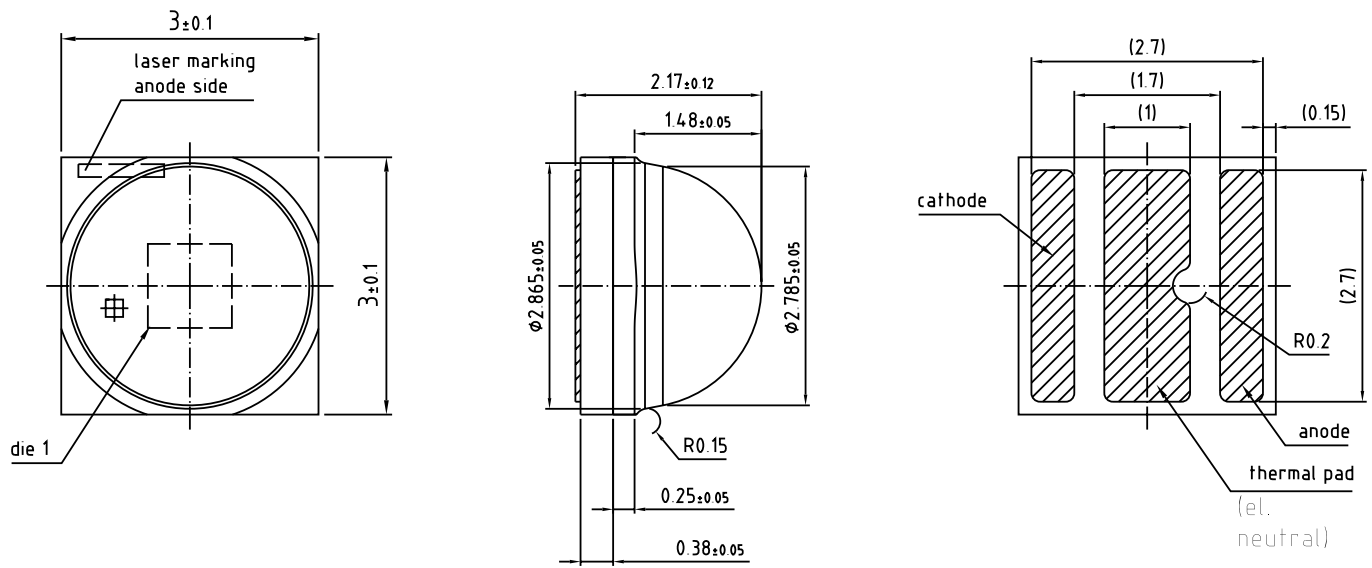

C69062-A0014-A2-01

Further Information:

Approximate Weight: 27.7 mg

Package marking: Anode

ESD advice: The device is protected by ESD device which is connected in parallel to the Chip.

Recommended Solder Pad ⁷⁾

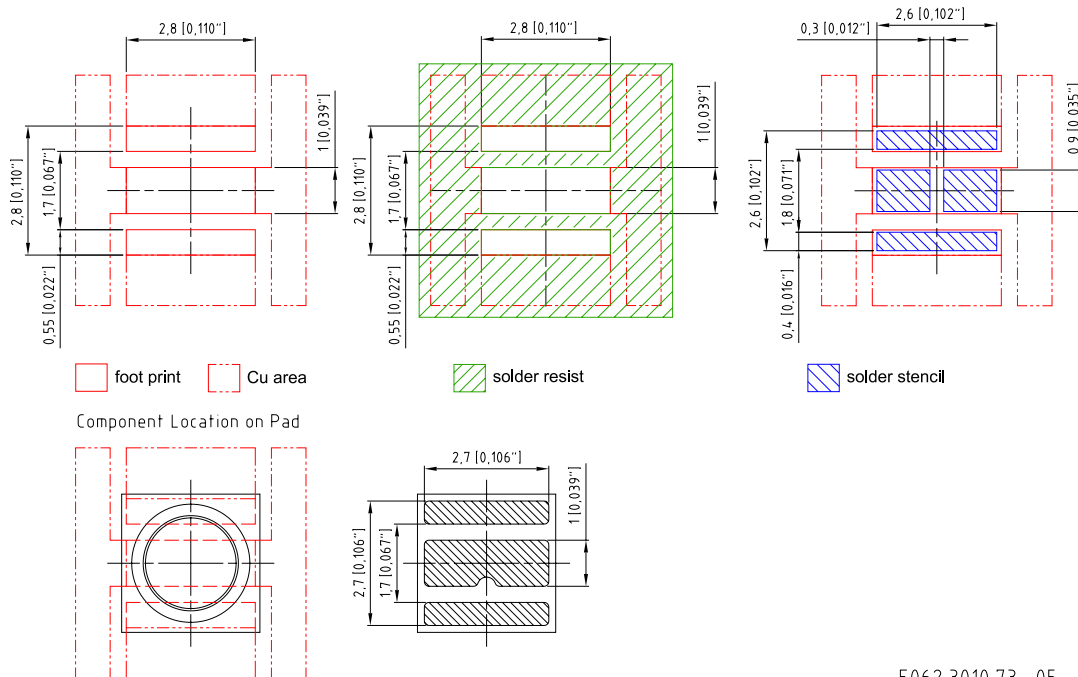

E062 3010.73 -05

For superior solder joint connectivity results we recommend soldering under standard nitrogen atmosphere. Further information can be found in our Application Note: "Handling and Processing Details for Ceramic LEDs".

Reflow Soldering Profile

Product complies to MSL Level 2 acc. to JEDEC J-STD-020E

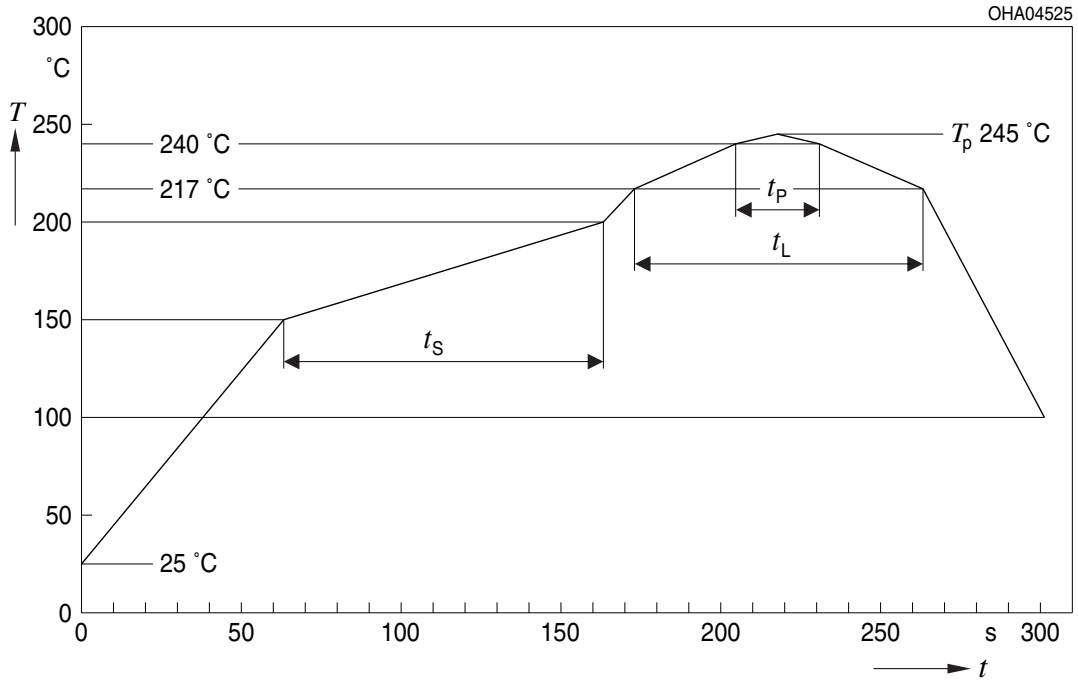

| Profile Feature | Symbol | Pb-Free (SnAgCu) Assembly | | | Unit |
|--|--------|---------------------------|----------------|---------|------|
| | | Minimum | Recommendation | Maximum | |
| Ramp-up rate to preheat ^{*)} 25 °C to 150 °C | | | 2 | 3 | K/s |
| Time t_s T_{Smin} to T_{Smax} | t_s | 60 | 100 | 120 | s |
| Ramp-up rate to peak ^{*)} T_{Smax} to T_p | | | 2 | 3 | K/s |
| Liquidus temperature | T_L | | 217 | | °C |
| Time above liquidus temperature | t_L | | 80 | 100 | s |
| Peak temperature | T_p | | 245 | 260 | °C |
| Time within 5 °C of the specified peak temperature $T_p - 5$ K | t_p | 10 | 20 | 30 | s |
| Ramp-down rate* T_p to 100 °C | | | 3 | 6 | K/s |
| Time 25 °C to T_p | | | | 480 | s |

All temperatures refer to the center of the package, measured on the top of the component
 *) slope calculation DT/Dt : Dt max. 5 s; fulfillment for the whole T-range

Taping ⁷⁾

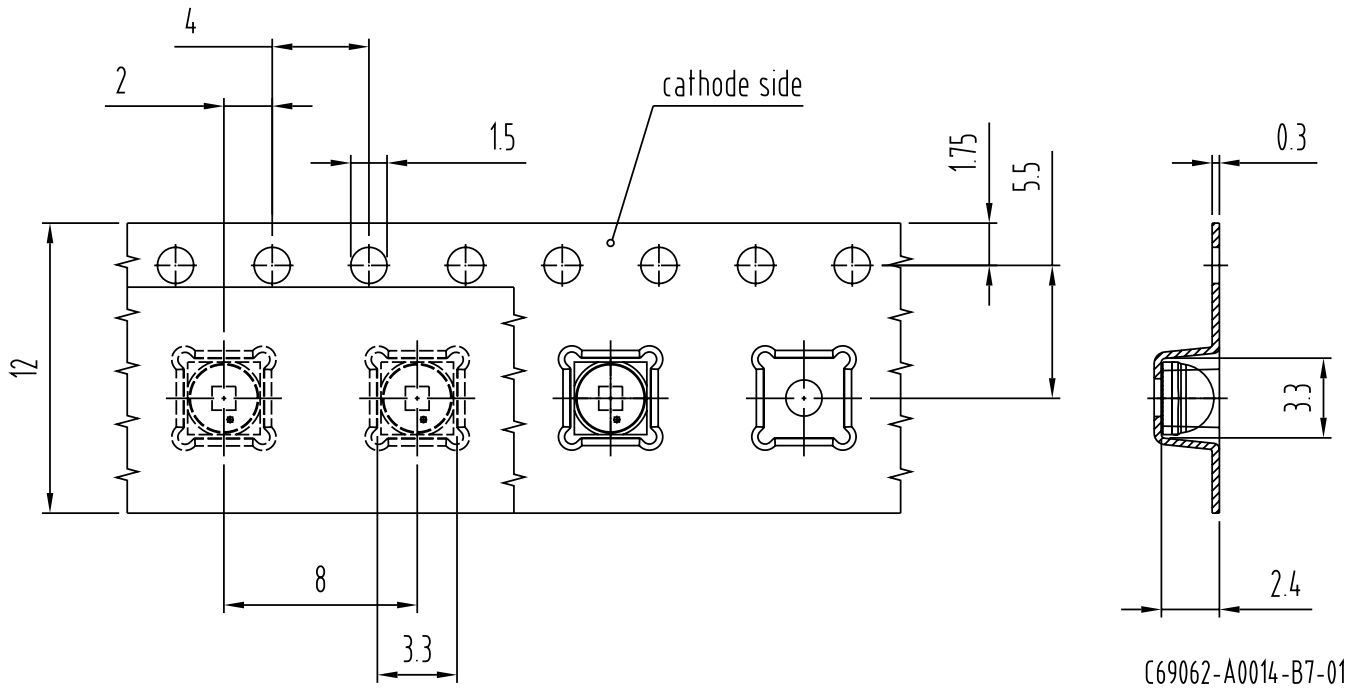

Tape and Reel ⁸⁾

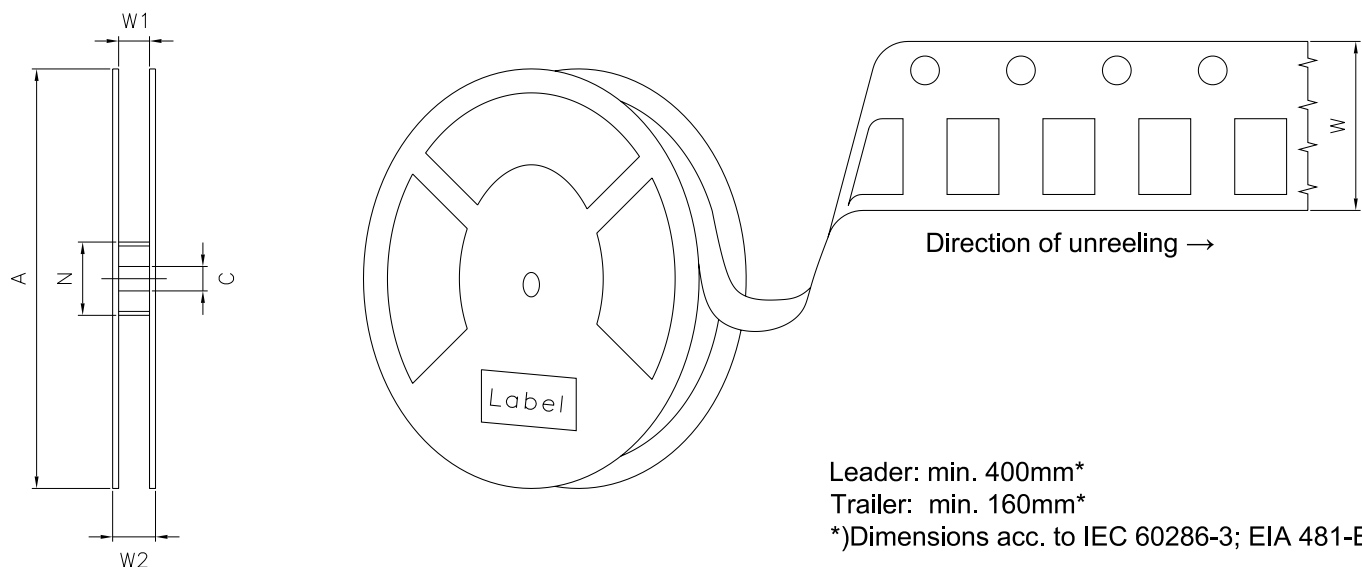

Reel Dimensions

| A | W | N_{\min} | W_1 | $W_{2\max}$ | Pieces per PU |
|--------|-----------------------|------------|---------------|-------------|---------------|
| 330 mm | $12 + 0.3 / - 0.1$ mm | 60 mm | $12.4 + 2$ mm | 18.4 mm | 3000 |

Barcode-Product-Label (BPL)

OSRAM Opto Semiconductors LX XXXX BIN1: XX-XX-X-XXX-X





RoHS Compliant

(6P) BATCH NO: 1234567890 ML Temp ST
X XXX °C X

(1T) LOT NO: 1234567890 (9D) D/C: 1234

Pack: RXX
DEMY XXX
X_X123_1234.1234 X

(X) PROD NO: 123456789(Q)QTY: 9999 (G) GROUP: XX-XX-X-X

OHA04563

Dry Packing Process and Materials



OHA00539

Moisture-sensitive product is packed in a dry bag containing desiccant and a humidity card according JEDEC-STD-033.

Notes

The evaluation of eye safety occurs according to the standard IEC 62471:2006 (photo biological safety of lamps and lamp systems). Within the risk grouping system of this IEC standard, the device specified in this data sheet fall into the class **exempt group (exposure time 10000 s)**. Under real circumstances (for exposure time, conditions of the eye pupils, observation distance), it is assumed that no endangerment to the eye exists from these devices. As a matter of principle, however, it should be mentioned that intense light sources have a high secondary exposure potential due to their blinding effect. When looking at bright light sources (e.g. headlights), temporary reduction in visual acuity and afterimages can occur, leading to irritation, annoyance, visual impairment, and even accidents, depending on the situation.

Subcomponents of this device contain, in addition to other substances, metal filled materials including silver. Metal filled materials can be affected by environments that contain traces of aggressive substances. Therefore, we recommend that customers minimize device exposure to aggressive substances during storage, production, and use. Devices that showed visible discoloration when tested using the described tests above did show no performance deviations within failure limits during the stated test duration. Respective failure limits are described in the IEC60810.

This device is designed for specific/recommended applications only. Please consult OSRAM Opto Semiconductors Sales Staff in advance for detailed information on other non-recommended applications (e.g. automotive).

Change management for this component is aligned with the requirements of the lighting market.

For further application related information please visit www.osram-os.com/appnotes

Disclaimer

Attention please!

The information describes the type of component and shall not be considered as assured characteristics. Terms of delivery and rights to change design reserved. Due to technical requirements components may contain dangerous substances.

For information on the types in question please contact our Sales Organization.

If printed or downloaded, please find the latest version on our website.

Packing

Please use the recycling operators known to you. We can also help you – get in touch with your nearest sales office. By agreement we will take packing material back, if it is sorted. You must bear the costs of transport. For packing material that is returned to us unsorted or which we are not obliged to accept, we shall have to invoice you for any costs incurred.

Product and functional safety devices/applications or medical devices/applications

Our components are not developed, constructed or tested for the application as safety relevant component or for the application in medical devices.

Our products are not qualified at module and system level for such application.

In case buyer – or customer supplied by buyer – considers using our components in product safety devices/ applications or medical devices/applications, buyer and/or customer has to inform our local sales partner immediately and we and buyer and /or customer will analyze and coordinate the customer-specific request between us and buyer and/or customer.

Glossary

- 1) **Brightness:** Brightness values are measured during a current pulse of typically 10 ms, with a tolerance of +/- 7%.
- 2) **Reverse Operation:** Not designed for reverse operation. Continuous reverse operation can cause migration and damage of the device.
- 3) **Wavelength:** The wavelength is measured at a current pulse of typically 10 ms, with a tolerance of ± 0.5 nm.
- 4) **Forward Voltage:** The Forward voltage is measured during a current pulse duration of typically 1 ms with a tolerance of $\pm 0.05V$.
- 5) **Typical Values:** Due to the special conditions of the manufacturing processes of semiconductor devices, the typical data or calculated correlations of technical parameters can only reflect statistical figures. These do not necessarily correspond to the actual parameters of each single product, which could differ from the typical data and calculated correlations or the typical characteristic line. If requested, e.g. because of technical improvements, these typ. data will be changed without any further notice.
- 6) **Characteristic curve:** In the range where the line of the graph is broken, you must expect higher differences between single devices within one packing unit.
- 7) **Tolerance of Measure:** Unless otherwise noted in drawing, tolerances are specified with ± 0.1 and dimensions are specified in mm.
- 8) **Tape and Reel:** All dimensions and tolerances are specified acc. IEC 60286-3 and specified in mm.

Revision History

| Version | Date | Change |
|---------|------------|-----------------|
| 1.0 | 2022-04-27 | Initial Version |



EU RoHS and China RoHS compliant product

此产品符合欧盟 RoHS 指令的要求；
按照中国的相关法规和标准，
不含有毒有害物质或元素。

Published by ams-OSRAM AG

Tobelbader Strasse 30, 8141 Premstaetten, Austria

Phone +43 3136 500-0

ams-osram.com

© All rights reserved

am 

OSRAM