

MaxiBridge

2.54 mm Connectors

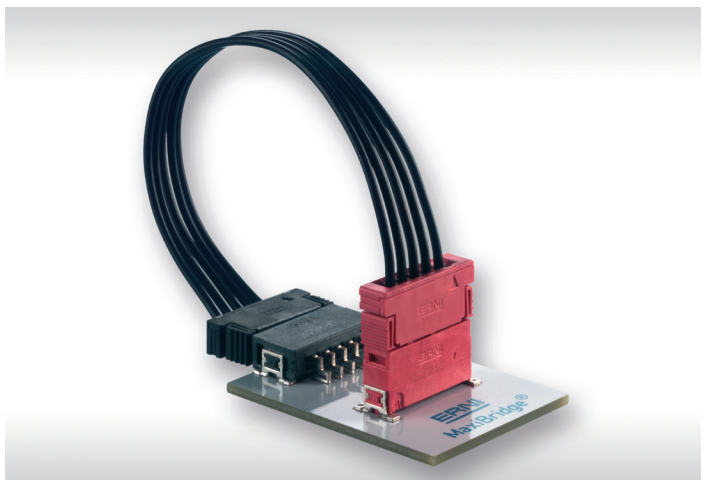
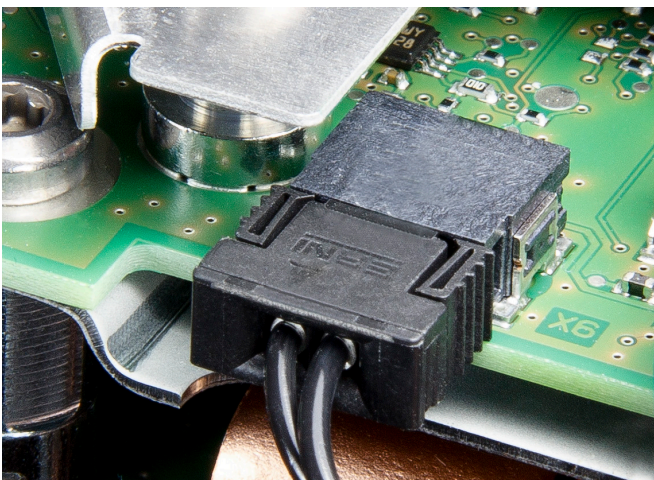

MaxiBridge - CABLE CONNECTOR SYSTEM

The 2.54 mm single and dual row cable connector system is excellently suitable for reliable and space saving connections between Printed Circuit Boards (PCB) and decentral units, e.g. lamps or info panels, front plate elements like buttons, switches or LEDs, motors, fans etc. The cable system can be used in different applications, for example: automotive, industrial, medical or even lighting technology. Thanks to the availability of vertical and right angle male connectors and female connectors with 180° cable outlet the system can be used in a versatile manner. Emphasis is put on flexibility of the usable cable sizes. Thus the required current rating can be adjusted over a wide range.

The vertical and right angle male connectors provide Surface Mount Technology (SMT) terminals and the female connector has contact cavities according to the crimp contacts. The plastic material used is suitable for lead-free reflow soldering. Tape and reel packaging and pick and place pad for automatic assembly is a standard.

The crimp contacts are secured twice and reach high retention forces. For each pin number, there are four mechanical and different colored coding versions with high blocking forces against mismatching available. Cable and male connector have a locking system on both sides, which helps prevent the contact from loosening due to vibration. The robust interlocking can be manually released without tools.

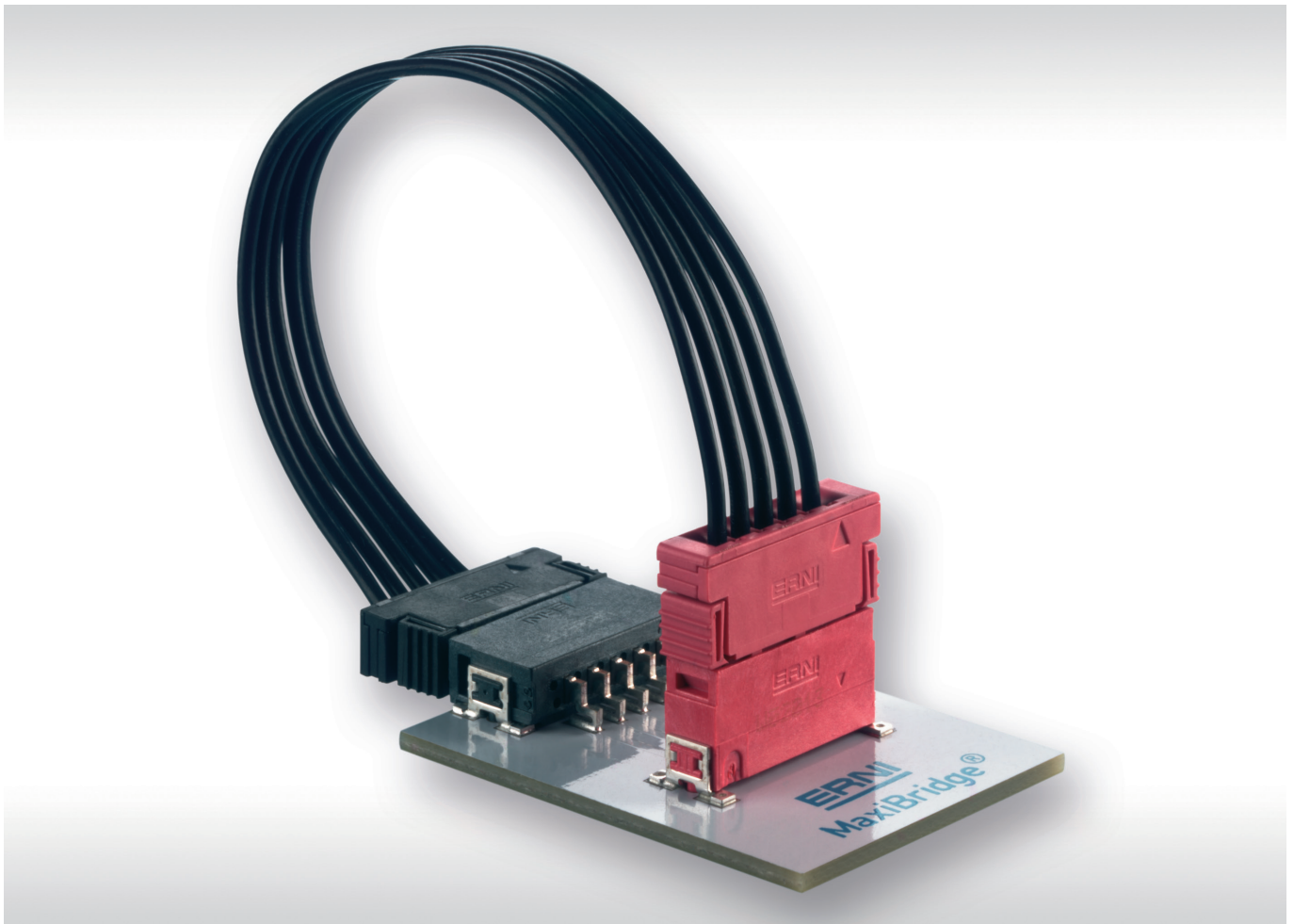

FEATURES

Pitch	2.54 mm
No. of Pins	2, 3, 4, 5, 6, 8, 2x5, 2x10
Current rating per contact	up to 12 A (depends on cable)
Termination technology	Male connector SMT, female connector crimp
Cables	Single stranded wires American Wire Gauge (AWG) 20, AWG 22, AWG 24, AWG 26
Variants	Single row male connectors, vertical and right angle Dual row male connectors, vertical and right angle Cable assemblies: - Female connectors crimp, vertical
Coding	black, blue, green, red
Automotive standard	particular wire cross sections have been tested according to the requirements of LV214 for automotive connectors

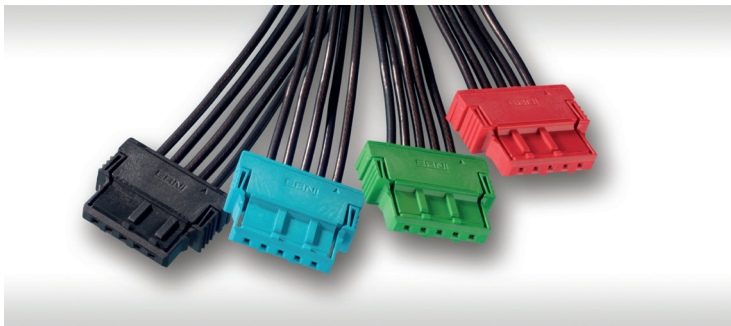

Robust interlocking with four different colored codings per pin number

CAPABILITIES

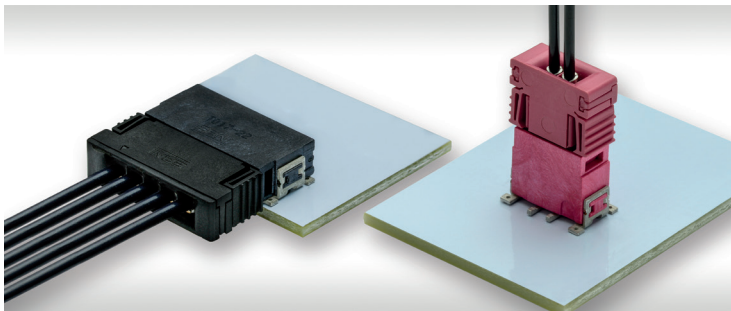

Single Row Variants

- right angle male - female with 180° cable outlet
- vertical male - female with 180° cable outlet

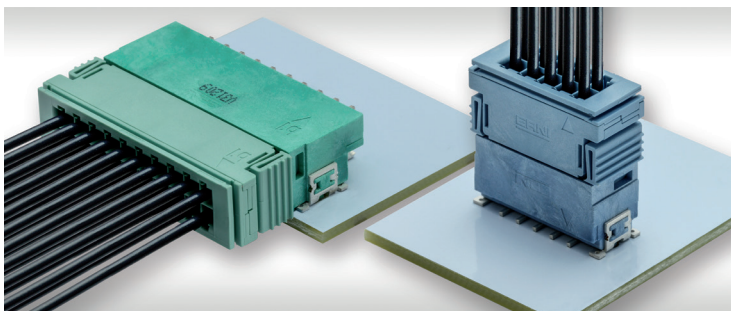

Dual Row Variants

- right angle male - female with 180° cable outlet
- vertical male - female with 180° cable outlet

FEATURES

Housing Guide

- The rugged insulation body of the male connector provides an highly reliable cable connector guide.



Locating Pegs

- Two pegs (round and oval) provides exact positioning on the PCB. In addition, they enable a compensation of the PCB hole tolerances.

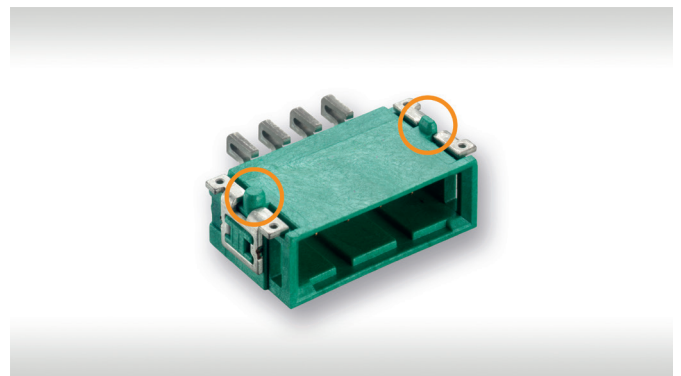

Easy Assembly

- Pick-and-place cover for automatic assembly of the vertical male connectors with a vacuum pipette.

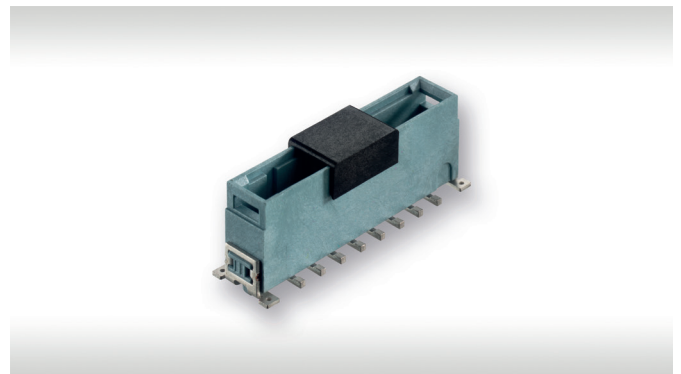

Robust Solder Clips

- Reliable retention force on the PCB due to ruggedized solder clips. In addition, they serve as an integrated strain relief.



FEATURES

Locking for Housing

- The robust locking system with latches on both sides can be manually released without tools and resist high vibrations. During the locking process, there is an audible latching.

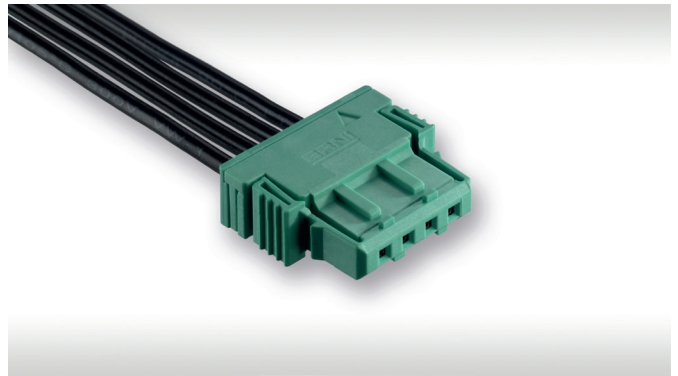

Contact Locking

- Primary and secondary locking of the crimp contact inside the connector housing.



Coding

- Four different colored codings per pin number. With high blocking forces against mismatching.

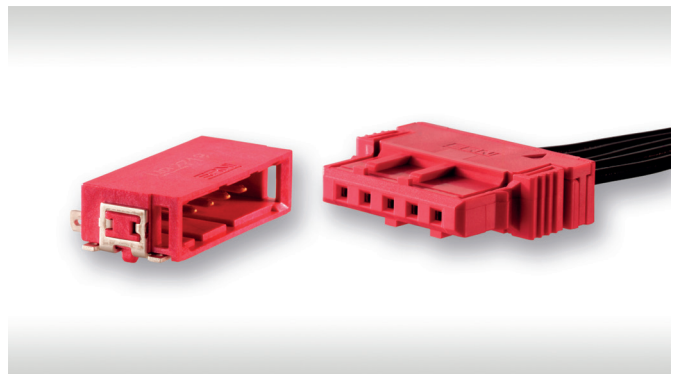

SSL-Lighting Technology

- Connectors with colorless insulation bodies help prevent shadow formation in lighting applications, e.g. LED strips with transparent diffusion disks. Thus providing uniform light distribution.

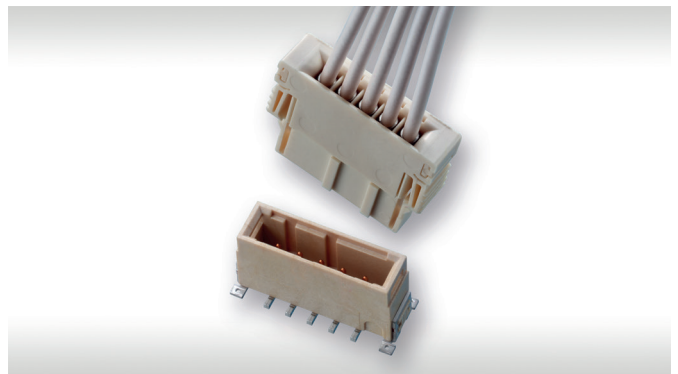

PROCESSING

Tape and Reel Packaging

- transport safe packaging
- automatic assembly.



Automatic Assembly and Reflow Soldering

- for efficient processing on modern assembly lines.

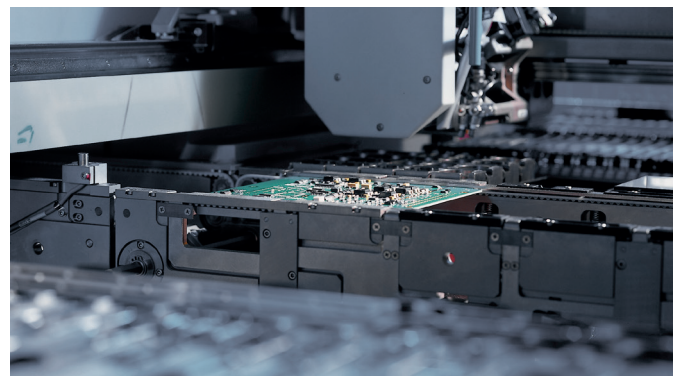

ELECTRICAL AND MECHANICAL CHARACTERISTICS

Technical Data

Description	Standard	Male Connectors Single and Dual Row	Female Connectors Single and Dual Row
Climate category	DIN EN 60068-1 test b		55 / 150 / 56
Temperature range			-55 / 150 °C
Current rating per contact	IEC 60512 test 5b		up to 12 A (depends on cable)
Air- and creepage distance			contact - contact min. 1.2 mm
Operating voltage	IEC 60664	The permissible operating voltages depend on the customer application and on the applicable or specified safety requirements. Insulation coordination according to IEC 60664-1 has to be regarded for the complete electrical device. Therefore, the maximum creepage and clearance distances of the mated connectors are specified for consideration as a part of the whole current path. In practice, reductions in creepage or clearance distances may occur due to the conductive pattern of the printed board or the wiring used, and have to be taken into account separately. As a result the creepage and clearance distances for the application may be reduced compared to those of the connector.	
Dielectric strength	IEC 60512 test 4a		contact - contact 1000 V _{rms}
Contact resistance	IEC 60512 test 2a		≤ 20 mΩ
Insulation resistance	IEC 60512 test 3a		≥ 10 ⁴ MΩ
Broadband noise	DIN EN 60068-2-64		10 – 1000 Hz 27.8 m/s ²
Contact disturbance (while broadband noise)	DIN EN 60068-2-64		< 1 μs
Shock half sine	IEC 60068-2-27		30 g 6 ms
Contact disturbance (while shock test)	IEC 60512 test 2e		< 1 μs
Mechanical operation	IEC 60512 test 9a		500 mating cycles
Insertion and withdrawal force	IEC 60512 test 13b		≤ 1 N per contact
Gauge retention force	IEC 60512 test 16e		> 0.15 N
Processing Conditions			
Hand soldering temperature max.	IEC 60068-2-20		3.5 s at 350 °C
Reflow soldering temperature max.	JEDEC J-STD-020		30 s at 260 °C
Coplanarity			< 0.1 mm

ELECTRICAL AND MECHANICAL CHARACTERISTICS

Technical Data

Description	Standard	Male Connectors Single and Dual Row	Female Connectors Single and Dual Row
Housing Material			
Insulation body		LCP	PA46
CTI value	IEC 112	175	225
UL flame rating		UL 94 V-0	UL 94 V-0
UL file plastic material		E83005	E47960
Contact Material			
Base material		Cu alloy	
Mating area		gold plating	
Termination area		Sn	
Environment Compatibility			
Recycling		no flame-retardant additives, no toxic additives allow easy recycling	
Product Approval			
UL		E84703	

RIGHT ANGLE MALE, SINGLE ROW

Product Specification

- SMT termination
- single row connectors
- current rating up to 12 A per contact
- automated board assembly
- four different colored codings
- for available part numbers please refer to our website



Dimensional Drawings

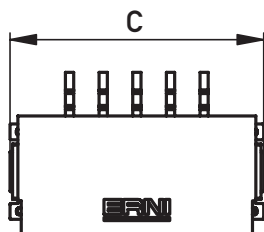
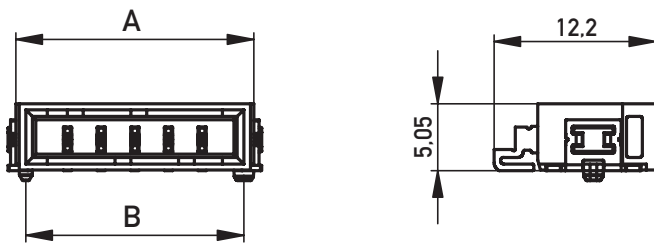

No. of Contacts	A	B	C
2	10.34	8.84	11.54
3	12.88	11.38	14.08
4	15.42	13.92	16.62
5	17.96	16.46	19.16
6	20.50	19.00	21.70
8	25.58	24.08	26.78

All dimensions in mm

Recommended Layout

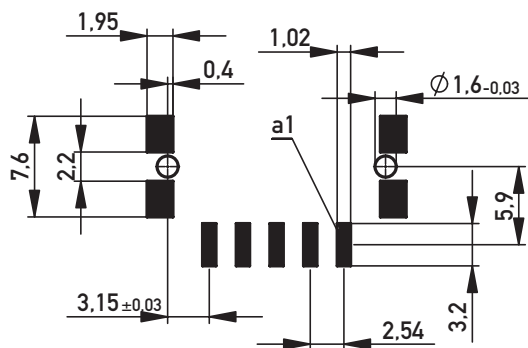

RIGHT ANGLE MALE, DUAL ROW

Product Specification

- SMT termination
- dual row connectors
- current rating up to 12 A per contact
- automated board assembly
- four different colored codings
- for available part numbers please refer to our website



Dimensional Drawings

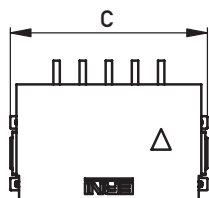
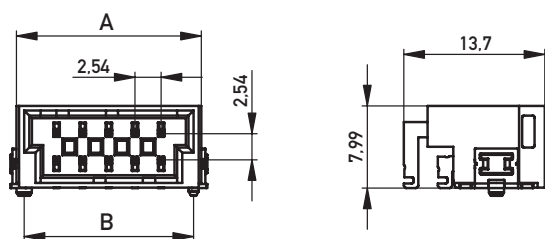

No. of Contacts	A	B	C
10	17.96	16.46	19.16
20	30.66	29.16	31.86

All dimensions in mm

Recommended Layout

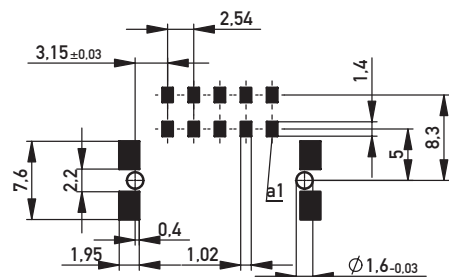

VERTICAL MALE, SINGLE ROW

Product Specification

- SMT termination
- single row connectors
- current rating up to 12 A per contact
- automated board assembly
- four different colored codings
- for available part numbers please refer to our website

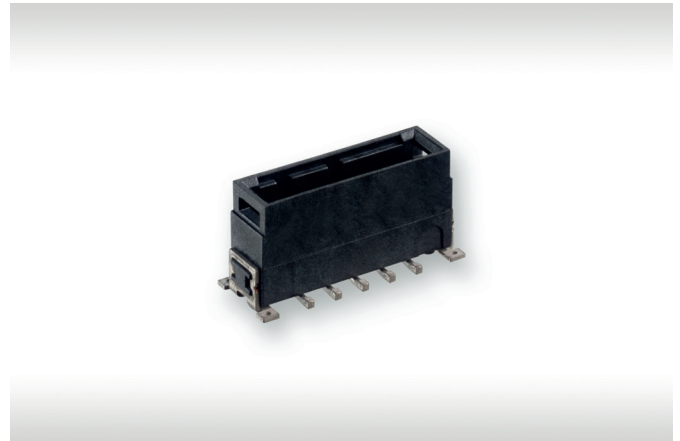

Dimensional Drawings

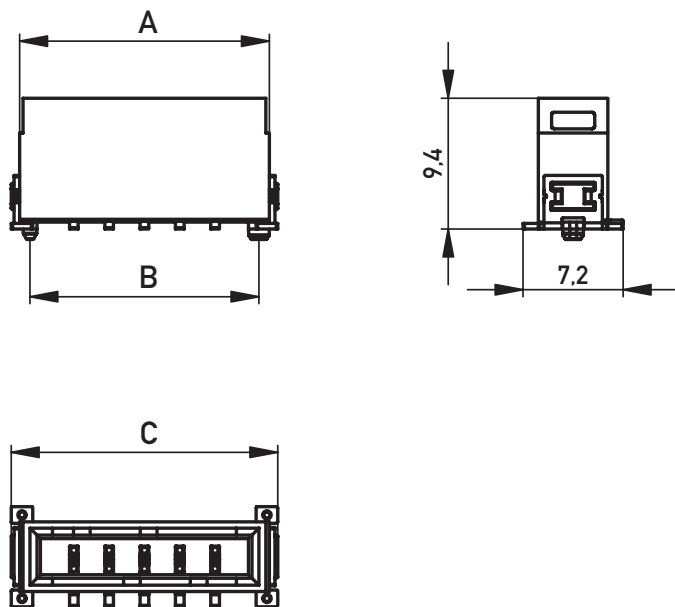

No. of Contacts	A	B	C
2	10.34	8.84	11.54
3	12.88	11.38	14.08
4	15.42	13.92	16.62
5	17.96	16.46	19.16
6	20.50	19.00	21.70
8	25.58	24.08	26.78

All dimensions in mm

Recommended Layout

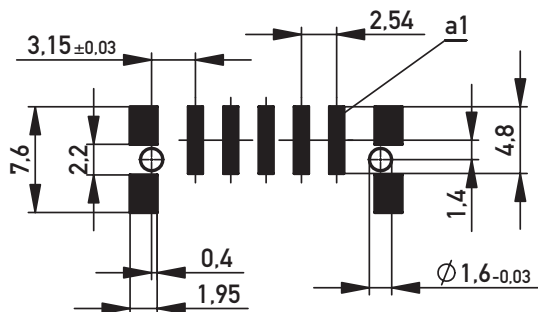

VERTICAL FEMALE, SINGLE ROW

Product Specification

- crimp contact with primary and secondary locking
- single row connectors
- current rating up to 12 A per contact
- four different colored codings
- for available part numbers please refer to our website



Dimensional Drawings

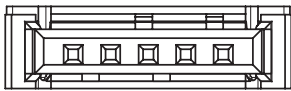

Cover loose mounted

Cover pressed on

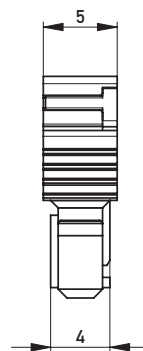
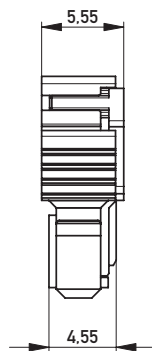
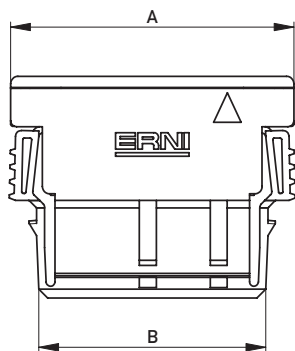

No. of Contacts	A	B
2	11.54	7.74
3	14.08	10.28
4	16.62	12.82
5	19.16	15.36
6	21,70	17.90
8	26.78	22.98

All dimensions in mm

Crimp contact

Single stranded wires

- AWG 20
- AWG 22
- AWG 24
- AWG 26



VERTICAL FEMALE, DUAL ROW

Product Specification

- crimp contact with primary and secondary locking
- single row connectors
- current rating up to 12 A per contact
- four different colored codings
- for available part numbers please refer to our website

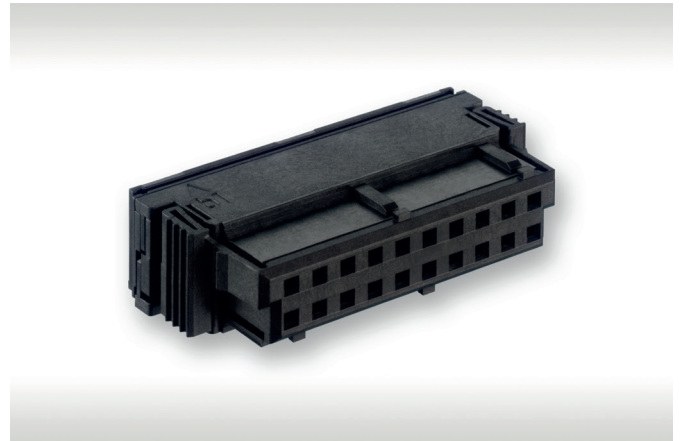

Dimensional Drawings

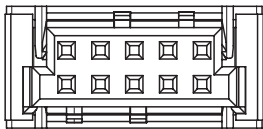

No. of Contacts	A	B
10	19.16	15.36
20	31.86	28.06

All dimensions in mm

Covers loose mounted

Covers pressed on

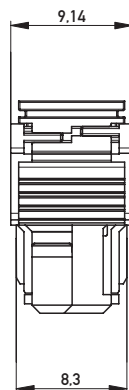
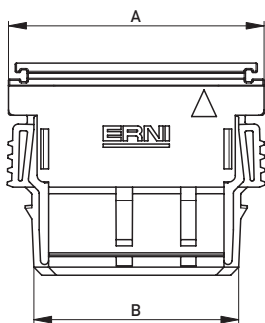

Crimp contact

Single stranded wires

- AWG 20
- AWG 22
- AWG 24
- AWG 26



CABLE ASSEMBLIES, SINGLE ROW

Product Specification

- cable assemblies with crimp female connectors
- single row connectors
- different cable types
- connectors with four different colored codings
- wire cross sections AWG 18, 20, 22, 24 and 26
- for available part numbers please refer to our website

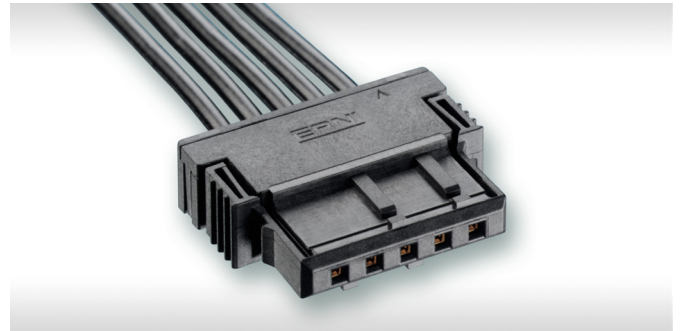

Dimensional Drawings

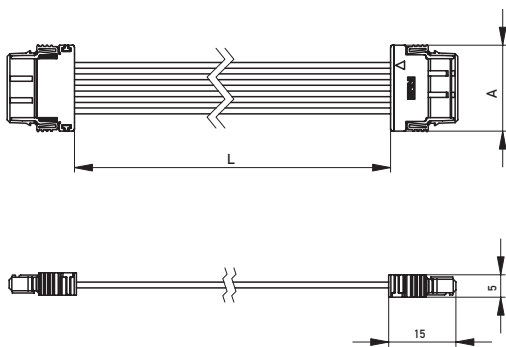

No. of Contacts	A
2	11.54
3	14.08
4	16.62
5	19.16
6	21.70
8	26.78

All dimensions in mm

CABLE ASSEMBLIES, DUAL ROW

Product Specification

- cable assemblies with crimp female connectors
- single row connectors
- different cable types
- connectors with four different colored codings
- wire cross sections AWG 18, 20, 22, 24 and 26
- for available part numbers please refer to our website

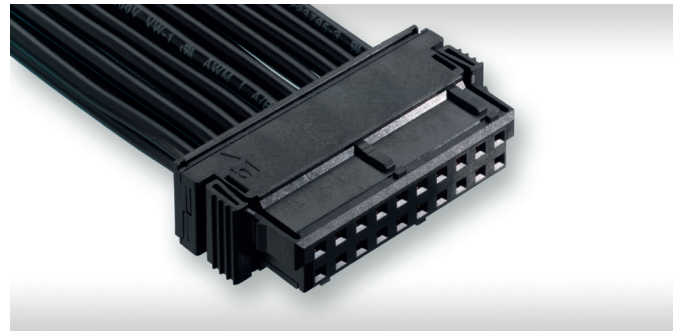

Dimensional Drawings

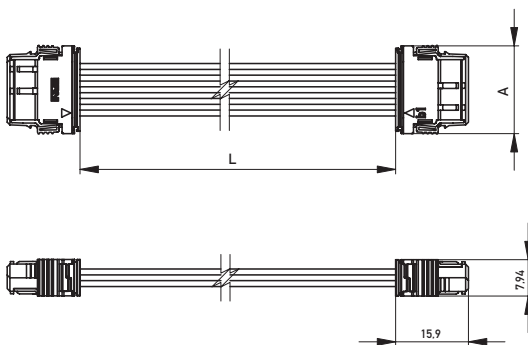

No. of Contacts	A
10	19.16
20	31.86

All dimensions in mm

Connect With Us

We make it easy to connect with our experts and are ready to provide the support you need. Visit www.te.com/support to chat with a Product Information Specialist.

te.com

2022 TE Connectivity. All Rights Reserved.

TE Connectivity, TE connectivity (logo), ERNI, MaxiBridge and Every Connection Counts are trademarks owned or licensed by the TE Connectivity family of companies. All other logos, products and/or company names referred to herein might be trademarks of their respective owners.

The information given herein, including drawings, illustrations and schematics which are intended for illustration purposes only, is believed to be reliable. However, TE Connectivity makes no warranties as to its accuracy or completeness and disclaims any liability in connection with its use. TE Connectivity's obligations shall only be as set forth in TE Connectivity's Standard Terms and Conditions of Sale for this product and in no case will TE Connectivity be liable for any incidental, indirect or consequential damages arising out of the sale, resale, use or misuse of the product. Users of TE Connectivity products should make their own evaluation to determine the suitability of each such product for the specific application.

074593 03/22 Original

CATALOG

TE Connectivity

ERNI Electronics GmbH & Co. KG
a TE Connectivity Ltd. company
Seestraße 9
73099 Adelberg
Germany

Tel +49 7166 50-0
www.te.com
www.erni.com