

THE INFORMATION CONTAINED IN THIS DRAWING IS THE SOLE PROPERTY OF L-COM, INC. ANY REPRODUCTION IN PART OR WHOLE WITHOUT THE WRITTEN PERMISSION OF L-COM, INC. IS PROHIBITED.

REVISIONS			
REV	DESCRIPTION	DATE	APPROVED
A	INITIAL RELEASE	04/19/2022	MMARTINEZ

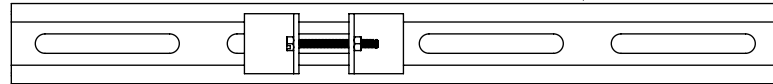

2X MOUNTS

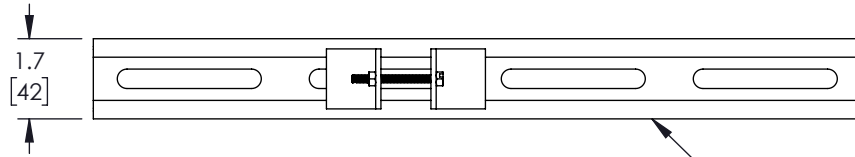
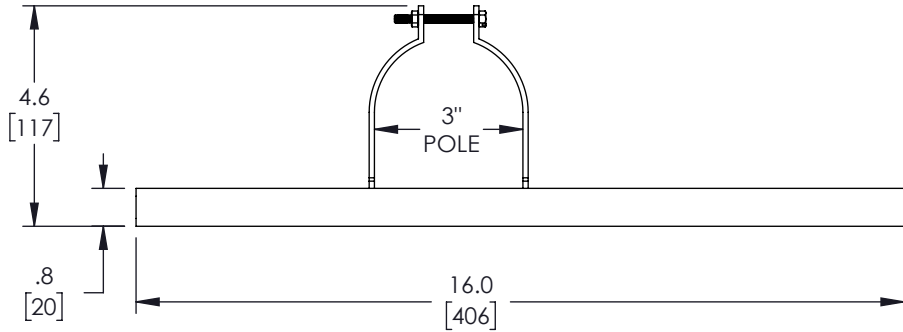
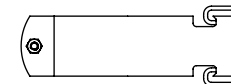
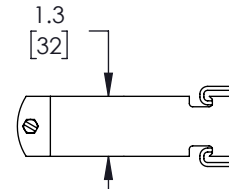

NOTES:

1. ALL HARDWARE INCLUDED

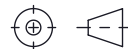
UNLESS OTHERWISE SPECIFIED, DIMENSIONS ARE IN INCHES [mm] OVERALL CABLE LENGTH TOLERANCE: ≤12 [305] = +1 [25] / -0 >12 [305] ≤60 [1524] = +2 [51] / -0 >60 [1524] ≤120 [3048] = +4 [102] / -0 >120 [3048] ≤300 [7620] = +6 [152] / -0 >300 [7620] = +5% / -0 ALL OTHER DIMENSIONAL TOLERANCES: .X = ± .2 [5] FRACTIONS ± 1/32 .XX = ± .02 [5] ANGLES ± 1° .XXX = ± .005 [13]	APPROVALS	DATE	 50 High Street, West Mill, North Andover, MA 01845 USA. Phone: 1.800.341.5266 1.978.682.6936	
	DRAWN BY BPUCHASKI	04/19/2022		CATEGORY ENCLOSURE
	CHECKED BY DFRISIELLO	04/19/2022		
	APPROVED BY MMARTINEZ	04/19/2022		
THIRD-ANGLE PROJECTION 	CONFIGURATION DETAILS OF UNDIMENSIONED FEATURES MAY VARY	PRODUCT DESCRIPTION POLEMOUNT FOR PC201608 ENCLOSURE 3 INCH POLE	SCALE: NONE CAD FILE: HGX-PMT36.SLDDRW SHEET 1 OF 1	
COLOR VARIATIONS MAY OCCUR		SIZE A CAGE CODE 43321 ITEM NO. HGX-PMT36	REV. A	