

Ω OMEGA® User's Guide



**Shop online at
omega.comSM**

**e-mail: info@omega.com
For latest product manuals:
www.omegamanual.info**

OM-PL SERIES Data Logger Interface Software



omega.com info@omega.com

Servicing North America:

U.S.A.:

Omega Engineering, Inc., One Omega Drive, P.O. Box 4047
Stamford, CT 06907-0047 USA

Toll-Free: 1-800-826-6342 (USA & Canada only)

Customer Service: 1-800-622-2378 (USA & Canada only)

Engineering Service: 1-800-872-9436 (USA & Canada only)

Tel: (203) 359-1660 Fax: (203) 359-7700

e-mail: info@omega.com

For Other Locations Visit omega.com/worldwide

Table Of Contents

Quick Start	4
Overview	4
Available Loggers	4
Connecting the Logger to Your PC.....	5
Setting Up The Logger To Record Data	6
Custom Interval Setup.....	7
Alarm Setup Window.....	7
Advanced Setup Window	8
Checking the Logger Status	9
Logger Status Light	9
Checking the Logger Status Using the Software	9
Finishing the Logging Session	10
Retrieving the Data from the Logger	10
Automatic Data Retrieval	11
Working with the Data Graph	12
Using the Zoom Feature	13
Data Information Window	14
Data Listing.....	14
Data Summary	15
Alarm Summary	15
Using the Data Filter	15
Data Units	16
Hiding and Viewing Channels	17
Saving and Loading Logger Data	17
Exporting Logger Data	17
Printing Logger Data	18
Calibrating the Logger	18
Changing The Calibration Password	19
Setting the Logger's Real Time Clock	19
Data Security	19
Logger Battery Replacement.....	20
OM-PL Logger Interface Software Specifications	21
OM-PLT2: Internal / External Temperature Logger	21

Connecting the External Temperature Probe to OM-PLT2	21
OM-PLT2 Battery Selection.....	21
OM-PLT2 Specifications	22
OM-PLTH: Temperature Humidity Logger.....	22
OM-PLTH Specifications.....	23
OM-PLTT: Dual External Temperature Logger.....	23
OM-PLTT Specifications	24
OM-PLPT: Pressure Temperature Logger.....	24
Connecting the Sensors to the OM-PLPT	24
OM-PLPT Specifications	25
OM-PLCV: AC Current, AC Voltage Logger	25
Connecting the OM-PLCV to Electrical Equipment.....	26
Connecting the OM-PLCV to both the Computer and a Voltage Source.....	26
OM-PLCV Specifications.....	27
OM-PL420: 4 - 20ma Current Loop Logger	27
Connecting the OM-PL420 to the 4 - 20 ma Loop.	27
OM-PL420 Specifications.....	28
OM-PLTC: Thermocouple Temperature Logger	28
OM-PLTC Logging Setup	28
OM-PLTC Safety Precautions	28
OM-PLTC Thermocouple Temperature Ranges.....	29
OM-PLTC Specifications.....	29

Quick Start

Follow the procedure below to quickly start using your new OM-PL data logger.

1. Connect an alkaline or lithium 9 volt battery to your logger. If the battery is connected correctly, the logger status LED will flash green five times.
2. If you have a serial (COM) port adapter, connect it to a free serial port on your computer. If you have a USB adapter, connect it to a free USB port on your computer. Refer to the "Connecting the Logger to Your PC " section for more information.
3. Open the logger sliding door and connect the supplied RJ12 cable to the logger. Connect the other side of the cable to the serial or USB interface adapter.
4. Start the OM-PL interface program.
5. From the **Logger** menu, select **Setup**
6. Select "**Logging starts when setup is complete**" option and click the **Continue** button.
7. Click OK when the warning message appears.
8. Click OK again.



The logger is now logging data. You can click on the  icon on the toolbar to download and view the data that has been logged.

Overview

The Omega OM-PL data loggers are versatile devices that can be used for a wide range of logging applications. Each logger is capable of sampling data as fast as once per second or as slow as once every 18 hours. Each logger can stop recording when memory becomes full, or rollover for continuous recording. The start of recording is software selectable to be immediate, delayed, or initiated when the logger door is closed.

The OM-PL loggers can also be used to monitor high and low alarm events, that indicate if the recorded data passed above and/or below the user selected threshold. The alarm events are stored separately from the data samples and are not affected by data rollover. When the recorded data passes the high or the low alarm threshold, the OM-PL logger records the time of the alarm. When the recorded data returns to within the acceptable range, the OM-PL logger records the duration of the alarm. Up to 50 such alarm events can be recorded. The logger has a visual indication of an alarm condition without the need to connect to the computer.

The OM-PL loggers have an internal real time clock/calendar. This real time clock is used to record the time stamps for data samples and alarm events. This real time clock is independent of your computer clock, and can be set separately, or set to match your computer clock.

The OM-PL loggers provide a high level of data security. They have physical security, where the data access door is locked, and software security. It is virtually impossible to falsify the sample data or alarm information of the OM-PL loggers.

The OM-PL loggers are extremely low power. Under normal operating conditions, a 9 volt alkaline battery will last from 18 months to 2 years.

Available Loggers

Omega offers the following loggers in the OM-PL family:

- OM-PLT2: Dual temperature logger. One temperature sensor is internal to the logger, the other is external.
- OM-PLTH: Temperature and Humidity logger. Both probes are internal to the logger.
- OM-PLTT: Dual temperature logger. Both sensors are external high temperature sensors.
- OM-PLPT: Pressure temperature logger. Both sensors are external.
- OM-PLCV: AC current and AC voltage logger.
- OM-PL420: 4 – 20 ma current loop logger.
- OM-PLTC: External thermocouple and internal temperature sensor logger. Supports J, K, T, E, R and S thermocouples.

Connecting the Logger to Your PC

Your computer interface kit comes with a Logger Interface Adapter.

If you purchased the OM-PLLS Kit, the adapter connects directly to your PC's 9 pin COM (serial) port. A 25 pin to 9 pin adapter may be necessary, if your computer only has a 25 pin serial port connector. An extension cable may be necessary on some computers.

If you purchased the OM-PLLS-USB Kit, the adapter connects to your PC's USB port, using the supplied USB cable. Your computer will automatically recognize the Interface Adapter.

To connect the logger to your computer, follow these steps:

1. Connect the interface adapter to a free COM (serial) port, or a free USB port as described above.
2. Open the sliding door of the logger and insert the supplied RJ12 cable into the logger.
3. Connect the other end of the RJ12 cable to the Interface Adapter.



4. Start the OM-PL program and click on the  icon on the toolbar.

The logger status screen should now be displayed.

If you are using the Serial (COM) Interface Adapter (OM-PLLS Kit), the adapter must be connected to a free serial port (a port that is not used by a modem, a mouse, or any other serial device). If the serial port was recently used for a modem or a mouse, Windows may still mark the port as busy. If the OM-PL interface software encounters problems detecting the logger, you may need to reboot your system for the logger to be correctly recognized.

If you are running the Palm HotSync Manager and are trying to connect the Serial (COM) Interface Adapter instead of the Palm HotSync cable, you will need to exit the Palm HotSync Manager in order for the OM-PL software to find the interface box. Exiting the HotSync Manager is not necessary when using the OM-PLLS-USB interface adapter.

Note: *The Windows operating system can not handle USB devices being unplugged and replugged too fast. When unplugging the OM-PLLS-USB, wait for about 5 seconds before plugging it (or any other USB device) in again. If you unplug and replug a device too quickly, the computer may stop recognizing any USB devices on that port. If this happens, the only solution is to restart the computer. This is a Windows USB problem and is not related to the OM-PL software.*

Setting Up The Logger To Record Data

To set your OM-PL logger to start recording data, select **Setup** from the **Logger** menu. The setup options window is shown below.

- **Sample Interval (Total Recording Length):** Select the sample interval from a predefined list of intervals. The sample interval greatly affects the battery life of the logger.
- **Custom Interval:** Adds your own interval to the sample interval list.
- **Enable Data Rollover:** Check this box to have the logger continuously record the data, overwriting earliest recorded data. When this box is not checked, logging is stopped when the logger memory becomes full.
- **Logging Control:** Logging can start in three ways depending on the selection you make:
 - **Logging Starts When Door Is Closed, Stops When Door is Opened:** Logging will not start until the sliding door is closed. Logging is stopped when the sliding door is opened. This mode does not allow real time monitoring of data. Logging must be stopped before the data can be retrieved. When the sliding door is opened the logger will flash the LED for 10 seconds, if the door is closed again during this interval, the logging will not stop.
 - **Logging Starts When Setup is Complete:** Logging will start immediately once the **Continue** button is pressed, and OK is clicked on the follow-up warning message. When logging is started in this way, the sliding door does not have any effect on logging, but can still be used to secure the logger.
 - **Logging Starts At This Time:** Logging will start at the user specified time. There is no limit how far

in the future you can set the logging to start. When logging is started in this way, the sliding door does not have any effect on logging, but can still be used to secure the logger.

- **Channels to Log:** You can elect to disable unused logger channels. When a channel is disabled, its memory is allocated to the other channels, increasing the total logging time. The total logging time will be reflected in the **Sample Interval** window. Depending on the logger, some channels are required and cannot be disabled. At least one channel must be enabled for logging.
- **User Information:** Enter any text you like in this box. This field is used to identify the logger to the user. You can enter descriptive location, serial number, etc.
- **Alarm Setup:** Click this button to open the **Alarm Setup Window**.
- **Advanced Setup:** Click this button to open the **Advanced Setup Window**.

Custom Interval Setup

Commonly used intervals are predefined in the Sample Interval box in the Logger Setup screen. If needed, however, a custom interval can be defined by the user. This is done by clicking on the **Custom Interval** button in the Logger Setup screen. The custom interval window will popup, as shown below. You can select a custom logging interval using this window.

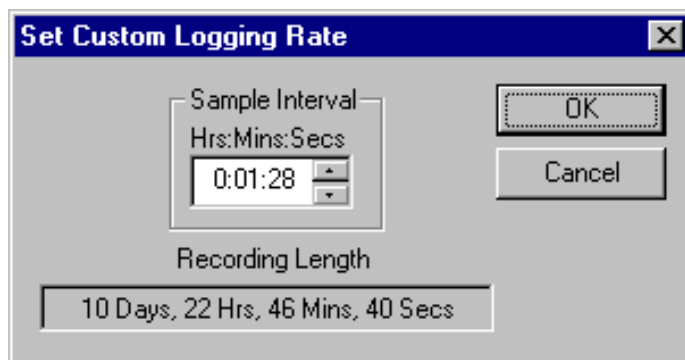

Alarm Setup Window

You get to the Alarm Setup Window by clicking the Alarm Setup button in the Logger Setup screen. Most loggers allow you to set high and/or low alarm thresholds for each logger channel, or disable these alarms. Alarms are set by entering the thresholds as shown in the window below.

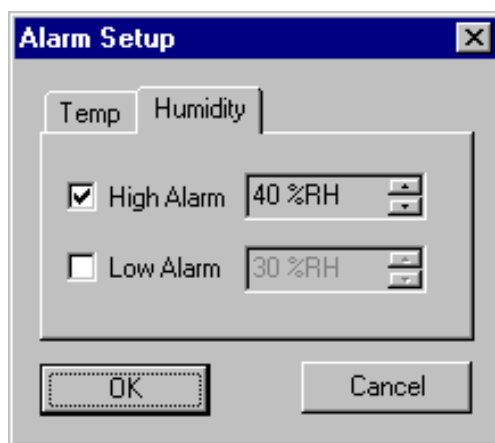

The checkbox to the left of the low/high alarms enables the alarm when checked, and disables the alarm when clear. Alarm resolution and availability is logger dependent. Check the logger documentation for more details.

Advanced Setup Window

The Advanced Setup window allows you to setup the status light (LED) flashing parameters during logging. You can change the brightness and the flash frequency of the status light.

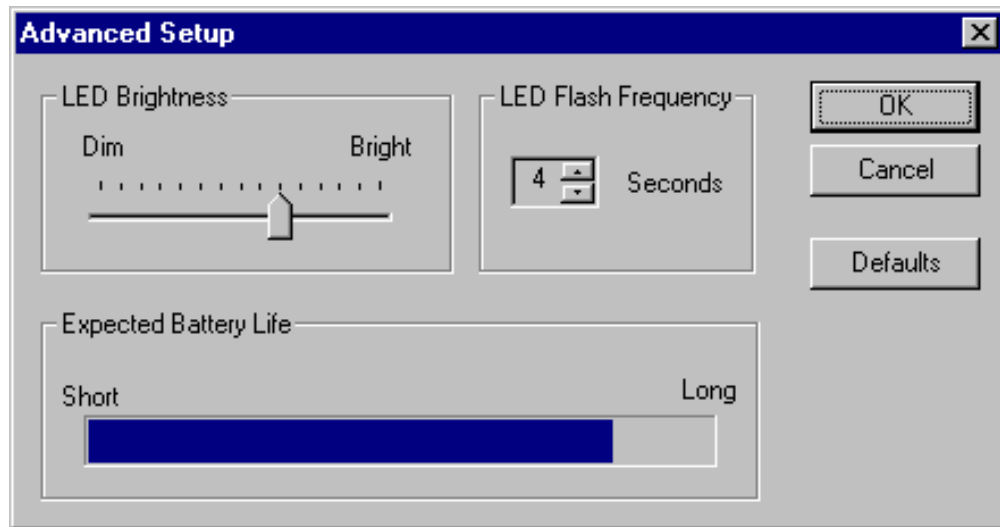

The defaults are:

LED Brightness: Dim

LED Flash Frequency: 5 Seconds

These values provide a good balance between good status indication and battery life. Since the status light uses power when lit, increasing its brightness and flash frequency will decrease the battery life. The expected battery life indicator shows how the parameters you selected affect the expected battery life.

Use the table below as a guide on how these parameters affect the battery life. The table assumes a logging interval of 1 minute and an alkaline battery.

LED Brightness	LED Flash Frequency	Average Battery Life
Dim	1 seconds	12 months
Dim	2 seconds	16 months
Dim	3 seconds	19 months
Dim	5 seconds	20 months
Dim	10 seconds	22 months
Dim	15 seconds	24 months
Medium	1 seconds	6 months
Medium	2 seconds	9 months
Medium	3 seconds	12 months
Medium	5 seconds	15 months
Medium	10 seconds	19 months
Medium	15 seconds	21 months
High	1 seconds	3 months
High	2 seconds	6 months
High	3 seconds	8 months
High	5 seconds	12 months
High	10 seconds	16 months
High	15 seconds	18 months

Checking the Logger Status

Logger status can be checked in two ways: By examining the Status light on the logger, or by selecting Status from the OM-PL software Logger menu.

Logger Status Light

The table below shows the different logger states that the status light can show. The interval of N seconds corresponds to the interval that you set in the LED Flash Frequency box in the Advanced Setup Window.

Status Light	Logger State
Flashes green 5 times in rapid succession.	Power up. The logger will flash this sequence right after a new battery is installed. This indicates that a new battery was installed correctly and that the logger is functioning correctly.
Flashes red then green, every N seconds.	The logger is in delayed logging state. This indicates that logging has been initiated, but the first sample has not been recorded yet. This occurs when delayed logging is chosen from the Setup screen.
Flashes green 4 times, 1 second apart.	Starting to log. This indicates that the logger is starting to log the first sample. This sequence will only show when the first data sample is logged.
Flashes green every N seconds.	Logging is in progress, no alarms occurred. The data logged is within the user specified minimum and maximum values for all the channels.
Flashes red every N seconds.	Logging is in progress, high or low alarms occurred. At least one data sample logged was outside the user specified minimum and maximum values.
Flashes red every half second for 10 seconds	The logger was setup to stop logging when the door is closed, and you've just closed the door. Reopen the door within the 10 seconds to continue logging. When the status light stops blinking, the logging has stopped.

Checking the Logger Status Using the Software

Selecting **Status** from the **Logger** menu brings up the Logger Status window shown below. You can also bring up

the status window by pressing the  button on the toolbar. The logger status screens are shown below.

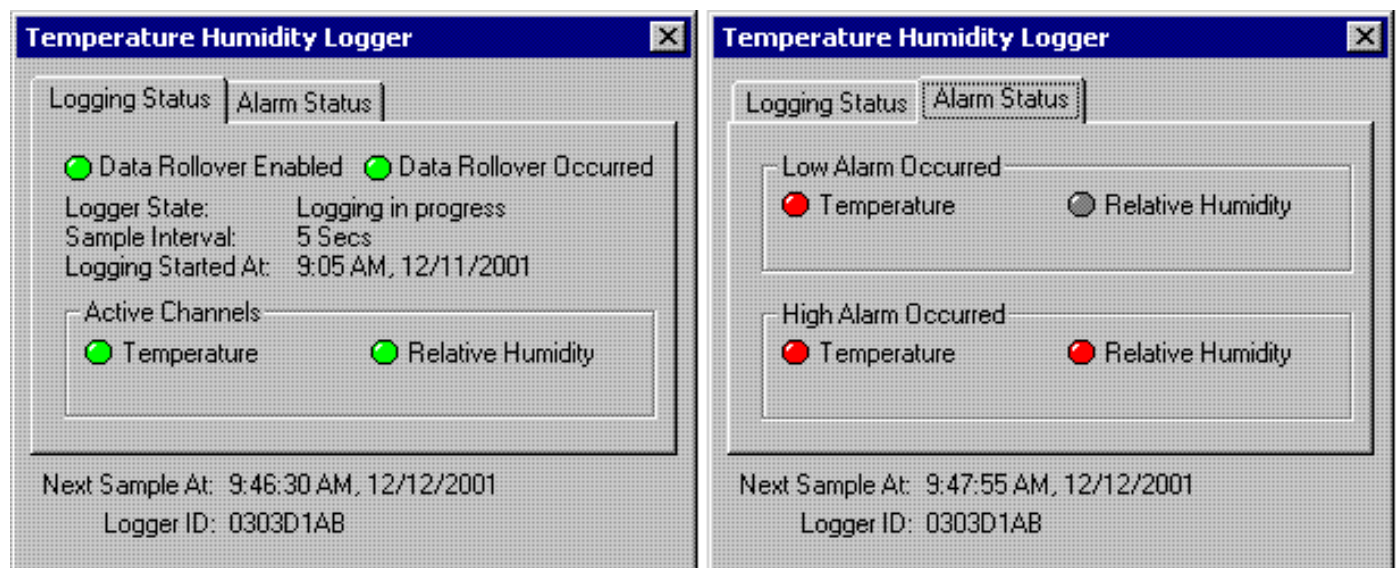

- **Data Rollover Enabled** and **Data Rollover Occurred** indicate the status of the data memory in the logger:

Data Rollover Enabled	Data Rollover Occurred	Status
OFF	OFF	The data rollover feature is not enabled in the logger
ON	OFF	The data rollover feature is enabled, but the recording has not reached the end of memory yet, so not data rollover has occurred.
ON	ON	Data rollover has occurred, and the earliest data samples are being overwritten with new ones.

- **Logger State** shows the internal state of the logger:

State	Description
<i>Powerup: Just Replaced Battery</i>	A new battery has just been placed into the logger. The logger has not performed logging or calibration since the battery has been inserted.
<i>Idle: Waiting For Setup</i>	The logger is not logging. It is waiting for a setup command.
<i>Waiting for door to close</i>	Logging has been selected to start when the logger door is closed. The logger is waiting for the door to close to start logging.
<i>Logging in Progress</i>	The logger is currently logging data.
<i>Waiting to log (Delayed Logging)</i>	Logging has been selected to start at a future time. The logger is waiting for this time to arrive to start logging.

- **Sample Interval** shows how often the logger is recording the data.
- **Logging Started At** shows at what time the logging has started.
- **Active Channels** shows what channels the logger was setup to log. The active channels are selected during logger setup.
- **Next Sample At** shows the time and date at which the next sample will be recorded. This time may be off when a very fast sampling period is selected (less than 5 seconds).
- **Logger ID** shows the unique logger ID assigned to the logger. This logger ID is assigned at the factory and can not be changed by the user.
- **Alarm Status** shows what alarms if any occurred for each channel. If the alarm occurred, the corresponding indicator will light red.

Finishing the Logging Session

There are a number of ways that the logging session can end:

1. When the logger memory becomes full, and data rollover was not selected during logger setup, the logger will automatically stop logging and enter the idle state.
2. If the logging session was started by closing the logger door (Logging Starts When Door Is Closed, Stops When Door is Opened option was selected from the setup screen), the logging can be stopped by opening the door. When the door is opened, the logger will flash the status light red for 10 seconds. If during this period the door is closed again, the logging will not stop. This helps preventing accidental stoppage of logging.
3. Selecting **End Logging** from the **Logger** menu.
4. If the logger detects a low battery condition, the logging will stop and the logger will enter the low battery state.
5. If the battery is removed from the logger, logging will stop. No data will be lost.

Once the logging has ended, it cannot be resumed without erasing the logged samples stored in the logger memory.

Retrieving the Data from the Logger

To get the sampled data from the OM-PL logger, connect the logger to your computer and click the  button on the toolbar, or select **Get Data** from the **Logger** menu. Once the data is transferred from the logger, the data graph

and listing windows will be displayed.

Logged data can be retrieved from the OM-PL logger at any time. You do not have to stop the logging session to retrieve the data, unless you selected to have the logger door control the logging.

The graph display will be blank if there are less than two data points logged. The listing window will be blank if there are no data points logged (as can happen during delayed logging, for example).

Automatic Data Retrieval

The OM-PL Interface Software can be setup to automatically load the data into the computer as samples become available. In this mode the graph and the listing windows are updated automatically with the new data.

To enable this feature follow these steps:

- Make sure that your OM-PL Logger is connected to your computer through the OM-PL Interface box.
- Make sure that the logger is logging data. Automatic retrieval is not available when the logger is not logging.
- Manually download the data for the first time by clicking the  button on the toolbar, or select **Get Data** from the **Logger** menu.
- From the **Logger** menu select **Auto Update**.

The computer will download data as often as the sampling interval you setup. For instance, if you set your logger to collect data once every minute, the software will perform a download once a minute. Of course the logger has to be connected to your computer while the Auto Update is active.

When the Auto Update is active, the software does not change the zoom level of your graph. Instead it scrolls the graph as new data becomes available.

Working with the Data Graph

Clicking anywhere within the graph window activates the graph toolbar buttons and the graph window features.

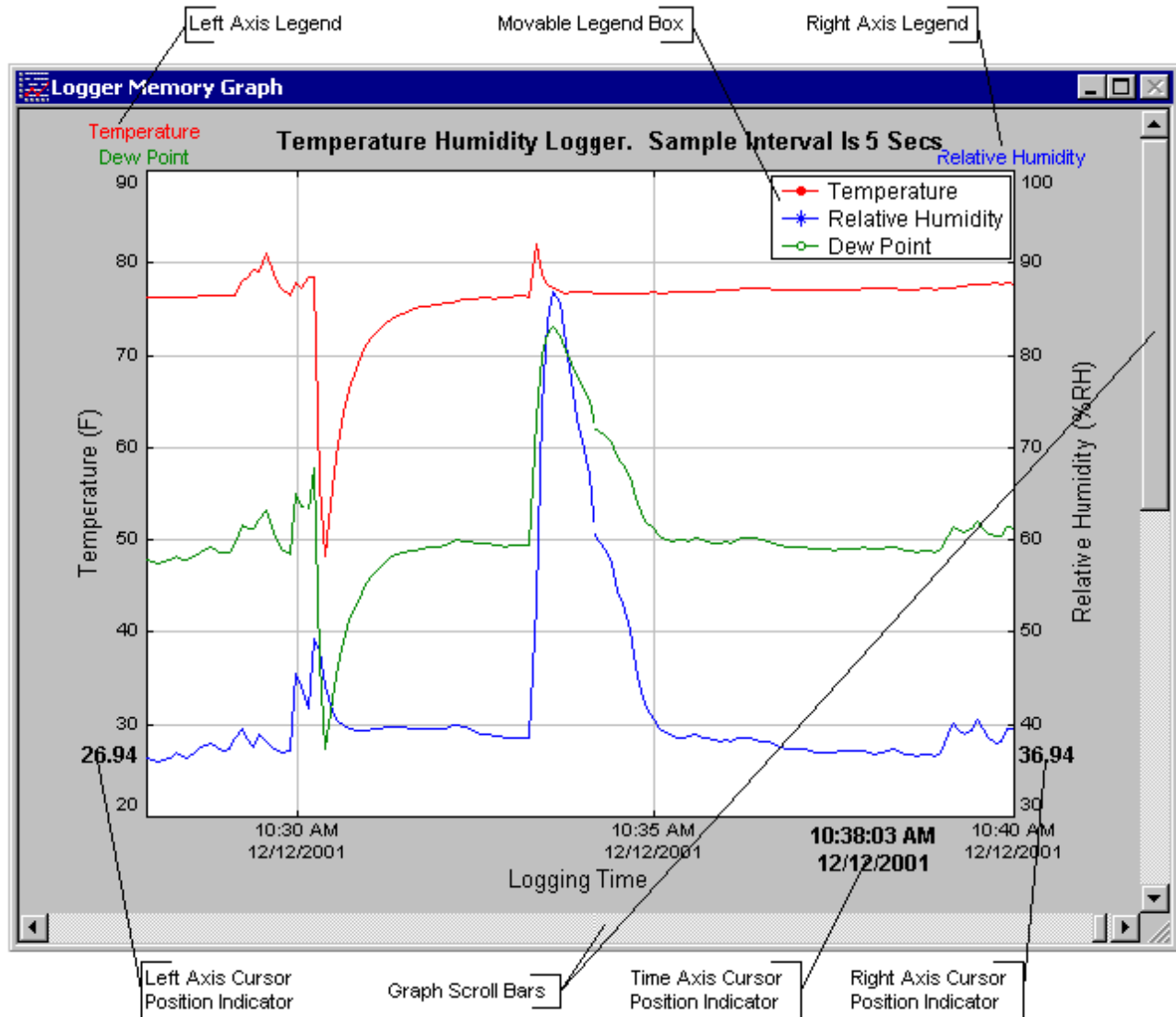

- The graph plots each data channel using a different color and dot style. A small rectangular legend shows the color and the dot style of each channel. This legend can be moved by clicking the left mouse button while inside the legend and dragging the legend to where you want it to be. The legend can be turned ON and OFF



by pressing the button on the toolbar, or using the menu and selecting the **View -> Plot -> Legend Box** option.

- There is an additional legend above each of the Y axis. This legend is the channel name drawn in the same color as the channel line on the graph. This legend helps identify which channel belongs to which axis. For instance, in the graph above, the Temperature in red and Dew Point in green correspond to the left Y axis, the Relative Humidity in blue corresponds to the right Y axis.
- The graph location indicators show the cursor position on the graph. The position is shown on each of the axis

in a slightly larger, bold text. The position indicators can be turned ON and OFF by pressing the  button on the toolbar, or using the menu and selecting the **View -> Plot -> Show Location** option.

- During zoom mode, you can use the vertical and horizontal scroll bars to move the graph around.



-  button turns ON and OFF marks at the data points.



-  button connects the sample points with a line.



-  button turns the grid lines ON and OFF.

Note that all the toolbar buttons described above have corresponding menu items under the **View -> Plot** option.

Using the Zoom Feature

There are a number of ways to zoom to the data you would like to see on the screen.

- **Graphic Zoom:** You can graphically zoom on the portion of the data that is displayed on the screen by pressing the left mouse button and dragging the box around the part of the graph you would like to zoom to. You can repeat this until the graph is zoomed to a single point. Pressing the right mouse button reverses the graphic zoom (causes unzoom).

- **Unzoom:** Pressing the left mouse button, then releasing without dragging the mouse causes the graph to unzoom (zoom out). Once again pressing the right mouse button reverses this zoom.



-  button on the toolbar causes the graph to unzoom to the full scale of the logger. The scale is determined by the capability of each logger. Choosing **Zoom -> Full Scale** from the menu has identical effect.



-  button on the toolbar causes the graph to unzoom to the full scale of the data. This means that the minimum and maximum scale will be about equivalent to the minimum and the maximum of the data. Choosing **Zoom -> Auto Scale** from the menu has identical effect.

- **Autoscaling a specific axis:** You can also autoscale the time or one of the data axes only, without affecting the other axes. To autoscale the time axis only, choose **Time -> Auto Scale** from the **Zoom** menu. To autoscale one of the data axis only, choose **Auto Scale** for the appropriate channel from the **Zoom** menu.

- **Numerical Zoom:** Another way to specify the zoom is to enter the minimum and maximum limits of the graph. You can do this individually for the time axis and for each of the data axis. To do this, select **Custom** for the appropriate axis from the **Zoom** menu, and enter the minimum and maximum limits for the axis.

Data Information Window

The Data Information window is separated into three panes: Data, Data Summary and Alarm Summary. The three panes are described below.

Data Listing

The data listing window is shown below.

Logger Memory Information

Logger Information

Logger Type: Temperature Humidity Logger
 User Information: Temperature Humidity Logger
 Logging Rate: 5 Secs

Data | Data Summary | Alarm Summary

Samp #	Temp (F)	Humidity (%RH)	Dew Point (F)	Date	Time
10667	77.02	38.49	49.82	12/12/2001	10:01:15 AM
▲ 10668	29.16 L	40.49	8.18	12/12/2001	10:01:20 AM
▲ 10669	24.86 L	40.15	4.11	12/12/2001	10:01:25 AM
▲ 10670	36.38 L	39.75	14.29	12/12/2001	10:01:30 AM
10671	44.39	39.47	21.32	12/12/2001	10:01:35 AM
10672	49.86	40.03	26.57	12/12/2001	10:01:40 AM
10673	54.26	41.34	31.31	12/12/2001	10:01:45 AM
▲ 10674	61.19	62.23 H	48.19	12/12/2001	10:01:50 AM
▲ 10675	62.37	77.14 H	55.12	12/12/2001	10:01:55 AM
▲ 10676	63.44	82.52 H	58.03	12/12/2001	10:02:00 AM
▲ 10677	64.42	78.21 H	57.49	12/12/2001	10:02:05 AM
▲ 10678	70.18	73.00 H	61.12	12/12/2001	10:02:10 AM
▲ 10679	74.87	67.70 H	63.47	12/12/2001	10:02:15 AM
▲ 10680	72.92	63.37 H	59.75	12/12/2001	10:02:20 AM
10681	72.13	58.72	56.89	12/12/2001	10:02:25 AM
10682	71.94	53.33	54.06	12/12/2001	10:02:30 AM
10683	77.21	49.78	57.02	12/12/2001	10:02:35 AM
▲ 10684	80.53 H	47.62	58.81	12/12/2001	10:02:40 AM
▲ 10685	82.10 H	45.82	59.16	12/12/2001	10:02:45 AM
▲ 10686	81.71 H	43.78	57.54	12/12/2001	10:02:50 AM
10687	79.66	42.62	54.95	12/12/2001	10:02:55 AM
▲ 10688	81.22 H	41.81	55.82	12/12/2001	10:03:00 AM
10689	79.56	40.97	53.78	12/12/2001	10:03:05 AM

Adjustable Column Width

Alarm Indicator

Alarm Polarity:
 H -- High Alarm
 L -- Low Alarm

The Data pane lists the data samples collected by the logger. If the data rollover check box in the setup window was cleared, the earliest data samples are listed. If the data rollover check box was checked, the latest data samples are listed.

The column width is adjustable by using the left mouse button and dragging the column to the desired width.

The  icon next to the data sample indicates an alarm condition. That is, one or both the data channels are outside the minimum and maximum (alarm low and alarm high) thresholds that you set. An *L* (low alarm condition) or an *H* (high alarm condition) is placed next to the sample that is actually outside the threshold.

The amount of data samples shown (and printed) can be reduced by using the data filter.

Data Summary

The data summary pane summarizes the information about the data. The following information is presented:

- Minimum and maximum value for each channel.
- Logging start time, last sample time and the total length of the recording.
- Samples recorded and samples stored. These will be different if data rollover occurred. Samples recorded count each data sampled by the logger. Samples stored only counts the samples that are actually stored in logger memory.
- Logger Info displays the logger id and the total lifetime recordings performed by the logger. The logger id is unique for each logger and cannot be changed by the user. The total recordings counter increases each time a new recording is initiated. It cannot be reset. These two information fields can be used to increase the data security of your logger.

Alarm Summary

The alarm summary pane lists the time of occurrence and the duration of both high and low alarms for each channel. Up to 50 separate alarm events are recorded. Alarm memory does not rollover, so only the 50 earliest alarms are shown.

Using the Data Filter

The data filter helps to display only relevant information in the data window. It can also decrease the number of printed pages when the data samples are printed. The data filter allows you to:

- Hide sample points when the data did not change sufficiently.
- Show only data points that were sampled in a specified time period.

To apply the data filter, select the **Data Filter...** option from the **View** menu. The filter selection dialog box is shown below.

Data Filter Settings

Show when within this date range

From 12/11/2001 9:05:00 AM

To 12/11/2001 10:45:45 AM

Don't Limit By Date

Temp | Humidity | Dew Point

Show when within this Temperature range

Low -40.0 F High 185.0 F

Show when Temperature changes by

0.1 F

Don't limit using Temperature

No Data Filter

OK

Cancel

The filter can be disabled by checking the "**No Data Filter**" box.

Sample range filtering can be disabled by checking the "**Don't limit using xxxx**" box for all the channels or for specific channels. Channels are selected by clicking on the channel pane.

Date range filtering can be disabled by checking the "**Don't Limit By Date**" box.

The filter settings apply consecutively. It is therefore very easy to find settings that will display no samples at all. The OM-PL program will give you a warning if you selected a filter that results in no samples being displayed.

Data Units

The units for each axis can be changed by selecting **Units >** from the **View** menu, and then selecting the axis for which you would like to change the units. The most widely used units are predefined in the program. The user can also choose custom units by manually entering the conversion factors. This is most useful for the OM-PL420 logger where the 4 – 20 ma loop usually corresponds to a physical measurement. The window below shows typical entries for a 4 – 20ma PH sensor.

Custom Unit Selection

Convert From: ma

Unit Name: PH Level Unit Abbreviation: PH

Conversion Point 1: 4 ma Equals 0.00 PH

Conversion Point 2: 20 ma Equals 14.00 PH

OK Cancel

Hiding and Viewing Channels

The OM-PL software has the ability to hide channels you do not wish to view. This feature is accessed by selecting **Channels >** from the **View** menu, and then deselecting or selecting the specific channels you wish to hide or view. The hidden channels do not appear in either the plot or the data listing. They also are not exported through the export to text and export to Excel features.

Saving and Loading Logger Data

Sample and alarm data retrieved from the logger can be saved in a file for viewing and analyzing at a later time.

To save the data, click the  button from the toolbar, or select **Save File...** from the **File** menu.

To load a saved file, click the  button from the toolbar, or select **Open File...** from the **File** menu.

OM-PL software stores the data in a proprietary binary format. However, data can be exported to text files that are compatible with various analysis tools. See Exporting the Logger Data section for more details. Exported text files cannot be loaded back into the OM-PL software.

Exporting Logger Data

The OM-PL software allows exporting sample, alarm and logging summary data to a text file. In addition, sample data can be exported to a Microsoft Excel file.

1. To export sample, alarm and logging summary data to a text file, from the **File** menu select **Export -> Text File**.
2. To export sample data to a Microsoft Excel file, from the **File** menu select **Export -> Excel File**.

The file exported to Microsoft Excel is a text file that Excel understands. To read the file into Microsoft Excel, follow these steps:

1. From the Microsoft Excel application choose **Open...** from the **File** menu.
2. In the *Open* window, under *Files of type:*, select *Text Files*.
3. Select the file you exported from the OM-PL program.
4. When the *Text Import Wizard* window opens, just click the **Finish** button.

Printing Logger Data

The OM-PL software can print the data graph, data samples, and a summary page. To print any of these, select **Print** from the **File** menu. You can also view how your data will be printed using the **Print Preview** option from the **File** menu.

Graphs and data samples are printed as they appear on the screen. For graphs, this includes the current zoom detail, marking of sample points, etc (see Working with the Data Graph for more detail).

For sample output, this means that any data filters applied to the data will be applied to the printed output as well. Data filters are especially useful for reducing the amount of pages that the data sample printout generates.

Calibrating the Logger

Your OM-PL logger is factory calibrated to an accuracy given in the logger specifications. However, there may be times when you wish to adjust the calibration of your logger. NIST traceable calibration is available at the factory for an additional cost. The OM-PL software provides you with a single point offset calibration. This calibration can be used to increase the accuracy of your logger for a small data range. For instance, if your application calls for logging temperature between 20F and 32F, you may want to calibrate your logger at 26F.

Note: Calibrating the logger erases the data that is stored in logger memory.

To calibrate your OM-PL logger, select **Calibrate...** from the **Logger** menu. For extra security, calibration is password protected. You must enter the correct password in the Calibration Password window before you're allowed to calibrate the unit. The Password Calibration window also allows you to change the password.

Once the password is entered correctly, a window asking you to select a channel pops up. Select the channel you would like to calibrate and click OK. Each channel must be calibrated separately.

The User Calibration window (shown below) will appear.

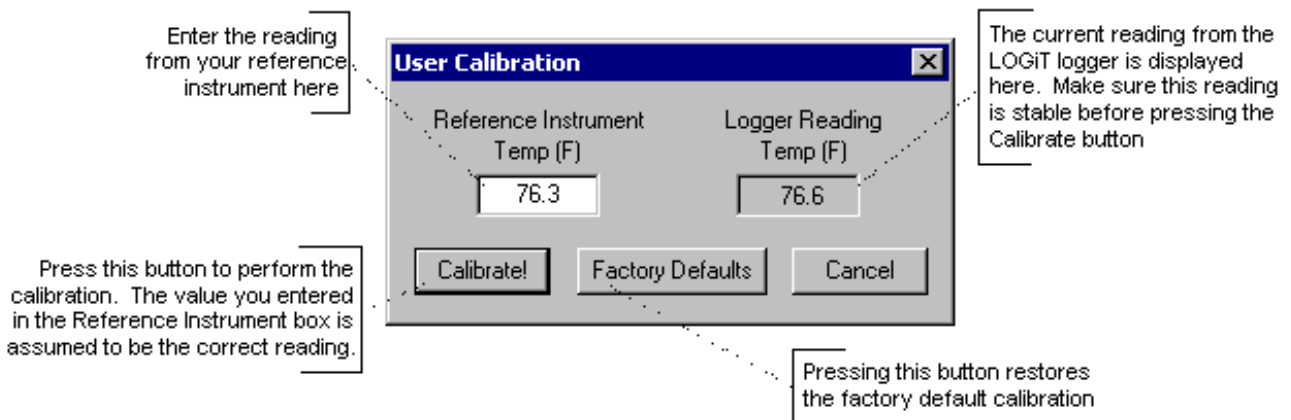

To perform the calibration:

1. Connect the reference sensor and the OM-PL sensor you are calibrating to the same source. For temperature and humidity, it is best to place the logger or the sensor in a stable chamber.
2. Bring the setup to the point at which you would like to perform the calibration.
3. Wait for your reference instrument and the reading in the "**Logger Reading**" box to stabilize.
4. Enter the reading from your reference instrument in the "**Reference Instrument**" box, and hit the **Calibrate!** button.

Changing The Calibration Password

To change the calibration password select **Calibrate...** from the **Logger** menu.



When the Calibration Password window is displayed, follow these steps:

Enter the current calibration password in the "**Enter Calibration Password**" box. Each OM-PL logger is factory configured not to have a password (do not enter anything in this box).

Enter the new password in the "**New Password**" box.

Enter the new password again in the "**Repeat New Password**" box.

Click OK.

You can also remove password protection (restore factory default empty password) by checking "**Remove Password**".

If you forgot the calibration password and need to reset it, click the "**Forgot Password**" button. This will reset the logger password to factory default (empty password). Resetting the password in this way will erase the data stored in the logger and reset the recording counter to 0.

Setting the Logger's Real Time Clock

The OM-PL loggers have an internal Real Time Clock. This clock is updated every second. During logging, the time stamps of the data samples and of the alarm occurrences are set by the Real Time Clock.

When you first connect a new battery to the logger and setup your logger for the first time, the OM-PL software automatically matches the logger clock to your computer's clock. However, you can also manually set the logger's real time clock.

To set the logger's Real Time Clock, from the **Logger** menu select **Set Clock...** Make sure that "Use Windows Clock" is unchecked, then enter the current date and time in the appropriate fields.

You cannot set the Real Time Clock while logging is in progress. You must end logging before the Real Time Clock can be set.

Data Security

The OM-PL loggers and the OM-PL software have a number of features to prevent third parties from tampering with and/or falsifying the logged data. The security features are as follows:

- After initiating the data logging, close the logger door and insert a lock into the hole in the logger case. This prevents the logger door from being open, which physically prevents a third party from connecting to the logger and changing or accessing the data.
- Each logger comes with a factory set unique logger id. The logger id is always displayed in the logger status window and the data summary window. The logger id cannot be written by the user. This prevents

somebody from switching loggers once the data is collected.

- Once logging has started, parameters such as sample rate, logging start time, logging sample counter, etc. cannot be changed without first clearing the recorded temperature and the alarm data. This prevents gathering many data samples at a fast sample rate and then lowering the sample rate to give the appearance that the data was recorded over a longer period of time.
- The OM-PL logger has an internal recording session counter. This counter counts how many times the logger was setup to record data. This counter cannot be reset even by unplugging the battery. This counter can be used to guarantee that the OM-PL data has not been cleared during a given period of time. If you know the value of the session after the logging session has started, you can guarantee that the OM-PL data has not been falsified if the session counter did not change. The session counter is available in the data summary window. These counters are read only and cannot be written to externally.
- The OM-PL internal real time clock cannot be changed during the logging session.
- The calibration data is password protected. This prevents a third party from recalibrating the unit to yield a false data and alarm reading.
- Calibrating the logger erases the logged data from the logger memory. This prevents somebody from adjusting the logged data after a recording is made.

Logger Battery Replacement

Replace the logger battery periodically to avoid loosing data, due to the battery becoming low. When a low battery condition is detected, the logger will stop any logging session and will enter a low battery state. In this state any access to the logger will result in the following error:



Before replacing the battery, make sure that the logger is not connected to the computer. If the logger is connected to the computer when the battery is replaced, the low battery condition will not be reset and the logger will remain inoperable. If this situation occurs, disconnect the battery, disconnect the logger from the computer, and connect the battery once more.

When the battery is replaced correctly, the logger status light will flash green five times in rapid succession.

General guidelines as to how long a battery will last is shown in the table below. It is assumed that the logger uses a fresh alkaline battery, the status flash frequency is set to 5 seconds, and the status flash is set to the dimmest setting.

Logging Sample Interval	Battery Life
1 second	3 months
5 seconds	10 months
10 seconds	15 months
30 seconds	19 months
1 minute	20 months
1 Hour	22 months

OM-PL Logger Interface Software Specifications

Sampling Interval	User selectable from 1 second to 18 hours, in 1 second increments.
Interface	OM-PLLS Kit: COM (RS232) serial port.OM-PLLS-USB Kit: USB Port (Not compatible with Windows 95 or Widnows NT).
Alarms	Visual alarms with user selectable low and high thresholds for every channel.
Alarm Memory	Up to 50 alarm events. Alarm start time and alarm duration is stored.
Data Security	Locking sliding door prevents physical access to the logger data. Unique factory set logger id. Data collection session counter.
Compatibility	Windows 95 and above. OM-PLLS-USB USB Kit is not compatible with Windows 95 or Windows NT.
Minimum System Requirements	8MB of RAM, 2M of disk space, 800 x 600 resolution, 1 free COM port or a free USB port.
Recording Start	On door close, immediate after setup, or at a user specified date and time.
Recording Mode	Stop on memory full, or continuous recording with memory rollover.
Real Time Status	Visual indication through the status LED. User selectable status display frequency and LED brightness. Software real time status.
User Calibration	Password protected calibration for each channel.
User Message	Up to 30 characters.
Logger Channels	User selectable. Disabling channels increases the storage capacity of the other channels
Units	US and Metric. User selectable units.
Data Format	Custom format exportable to text or Excel spreadsheet.
Real Time Monitoring	Logger can be permanently connected to the computer and used as a real time, multichannel sensor with logging capability. Battery does not drain when logger is connected to the computer.

OM-PLT2: Internal / External Temperature Logger

The OM-PLT2 Data Logger is a precision instrument for recording the temperature of the surrounding environment and/or the temperature of the external temperature probe. The remote probe allows the OM-PLT2 to record internal and external temperature simultaneously. The external temperature probe is interchangeable and replacement probes are available. The OM-PLT2 can store up to 21,500 temperature readings when a single probe (internal or external) is used. When both probes are enabled, 10,750 temperature readings can be recorded for each probe, as well as and the temperature difference between the internal and external probes.

The OM-PLT2 Data Logger has an internal temperature sensor and an external temperature probe. The external probe standard length is 15ft. It can be extended up to 300ft using an optional extension wire.

Connecting the External Temperature Probe to OM-PLT2

The OM-PLT2 external temperature probe is not polarized, which means that it does not matter in what order the two wires are connected to the logger.

OM-PLT2 Battery Selection

As with all the OM-PL loggers, you have a choice between using an Alkaline or a Lithium 9V battery. The loggers can operate twice as long Lithium battery than on an Alkaline battery. For the OM-PLT2 logger selecting the right battery has another important consideration. The internal temperature sensor is rated for temperatures between -40°F to 150°F (-40°C to 65°C). However, this range can only be achieved when using a Lithium battery. If you are using an Alkaline battery, the internal sensor temperature range is reduced to 32°F to 140°F (0°C to 60°C). This is because the Alkaline battery is not rated outside of this temperature range.

The temperature ranges are summarized in the table below.

Battery	Logger Operating Temperature	Internal Sensor Temperature Sensor	External Probe Temperature Range
9V Alkaline	32°F to 140°F (0°C to 60°C)	32°F to 140°F (0°C to 60°C)	-40°F to 150°F (-40°C to 65°C)
9V Lithium	-40°F to 150°F (-40°C to 65°C)	-40°F to 150°F (-40°C to 65°C)	-40°F to 150°F (-40°C to 65°C)

OM-PLT2 Specifications

Sample Point Capacity	21,500 points for single channel. 10,750 points per channel for dual channel.
External Probe	-40°F to 150°F (-40°C to 65°C), 15ft standard. Can be extended to 300 ft.
Logger Operating Temperature Range	32°F to 140°F (0°C to 60°C) using Alkaline Battery. -40°F to 150°F (-40°C to 65°C) using Lithium Battery.
Storage Temperature	-40°F to 170°F (-40°C to 77°C)
Ambient Operating Relative Humidity	0% to 95% non-condensing
Alarms	Over and under alarms for internal and external sensors. Alarms are not available for temperature difference between the sensors.
Calibration	User single point offset calibration is available through software for both internal and external sensors.
Time Accuracy	+/-100ppm @75°F
Temperature Resolution	0.1°F (0.05°C)
Temperature Accuracy	+/- 1.0°F (0.5°C)
Dimensions	3'' x 2.5'' x 1.1'' (7.6cm x 6.4cm x 2.8cm)
Weight	2.5 Oz (71g)
Power Source	9V Alkaline or Lithium battery.
Battery Life (average use)	19 Months using Alkaline Battery. 38 Months using Lithium Battery.

OM-PLTH: Temperature Humidity Logger

The OM-PLTH is a self-contained, precision instrument for recording the temperature and humidity of the surrounding environment. The OM-PLTH can store up to 21,500 temperature samples, or up to 10,750 of temperature and humidity samples. In addition to Temperature and Humidity, the OM-PL software computes and displays the Dew Point and the Wet Bulb Temperatures.

By default, the OM-PL software will only show the Temperature, Humidity and Dew Point data. To view the Wet Bulb Temperature data, from the **View** menu, select **Channels >**, and click on **Wet Bulb**. You can find more information in the Hiding and Viewing Channels section.

The OM-PLTH logger temperature and humidity sensors are open to the air. It is therefore important to ensure that water does not get into the unit. This is especially important in high humidity situations (90% RH and above) where water may condense inside the logger, damaging the logger.

Caution!!!

Care must be taken to ensure that the logger is not operating in condensing conditions. This means that the dew point temperature must be below the ambient temperature. Condensation may damage the humidity sensor and the logger electronics.

OM-PLTH Specifications

Sample Point Capacity	21,500 points for temperature only. 10,750 points of temperature, humidity, dew point, and wet bulb temperature.
Alarms	Over and under alarms for temperature and humidity. Dew point and wet bulb alarms are not available. Humidity alarms are accurate to +/- 5% RH.
Calibration	Humidity is factory calibrated. User single point offset calibration is available through software for both temperature and humidity.
Operating Temperature	32°F to 140°F (0°C to 60°C) using Alkaline Battery. -40°F to 150°F (-40°C to 65°C)* using Lithium Battery.
Storage Temperature	-40°F to 170°F (-40°C to 77°C)
Time Accuracy	+/-100ppm @75°F
Relative Humidity Range	0% to 99.9%RH, non condensing.
Relative Humidity Accuracy	+/- 2% full scale, from 0% to 95% RH for temperatures between 32°F and 140°F (0°C to 60°C)
Relative Humidity Resolution	0.1%RH
Temperature Accuracy	+/-2°F (1°C)
Temperature Resolution	0.1°F (0.05°C)
Dimensions	3'' x 2.5'' x 1.1'' (7.6cm x 6.4cm x 2.8cm)
Weight	2.5 Oz (71g)
Power Source	9V Alkaline or Lithium battery.
Battery Life (average use)	20 Months using Alkaline Battery. 40 Months using Lithium Battery.

*Note that humidity sensor accuracy is only guaranteed for temperature range of 32°F to 140°F (0°C to 60°C).

OM-PLTT: Dual External Temperature Logger

The OM-PLTT is a precision instrument for recording the temperature of two independent temperature probes. Each temperature sensor is enclosed within a 4 inch stainless steel jacket. The OM-PLTT temperature probes are interchangeable, and replacement probes are available. Each temperature sensor cable is 6ft long. The OM-PLTT can store 21,500 temperature samples when using a single probe. The OM-PLTT can store 10,750 temperature samples when using both probes. The temperature difference between probe 1 and probe 2 is also recorded.

The probe's stainless steel tip can be immersed in any solid or liquid that is compatible with 300 series stainless steel.

Compatible substances include, but not limited to: Water, steam, oil, Freon, hydraulic fluid, natural gas, propane.

Incompatible substances include, but not limited to: Acids such as nitric acid, sulfuric acid and hydrochloric acid. Any materials that are corrosive to steel.

Note that only the probe steel tip is media compatible. The probe cable is not water proof.

OM-PLTT Specifications

Sample Point Capacity	21500 temperature points for a single probe. 10750 temperature points and temperature difference, when using both probes.
Alarms	Over and under alarms for each external temperature probe. Alarms are not available for temperature difference.
Calibration	User single point offset calibration is available through software for both temperature sensors.
Logger Operating Temperature Range	32°F to 140°F (0°C to 60°C) using Alkaline Battery. -40°F to 150°F (-40°C to 65°C) using Lithium Battery.
Time Accuracy	+/-100ppm @75°F
Relative Humidity Range	0% to 95%RH non condensing
Probe Specification	Media compatible 4 inch stainless steel tip. 6ft cable. The probes are interchangeable.
Probe Temperature Range	-50°F to 300°F (-46°C to 150°C)
Temperature Accuracy	+/-2°F (1°C)
Temperature Resolution	0.1°F (0.05°C)
Dimensions	3'' x 2.5'' x 1.1'' (7.6cm x 6.4cm x 2.8cm)
Weight	2.5 Oz (71g)
Power Source	9V Alkaline or Lithium battery.
Battery Life (average use)	20 Months using Alkaline Battery. 40 Months using Lithium Battery.

OM-PLPT: Pressure Temperature Logger

The OM-PLPT data logger is a precision instrument for recording pressure and temperature. The logger can store up to 21,500 data points, when it is setup to record either pressure or temperature (but not both). The logger can store up to 10,750 points, when it is setup to record both pressure and temperature.

The external temperature probe is interchangeable and replacement probes are available. The pressure sensor is not interchangeable. Each logger is individually calibrated to the pressure sensor at the factory.

The pressure sensor is media compatible.

Compatible substances include, but not limited to: Water, steam, oil, Freon, hydraulic fluid, natural gas, propane.

Incompatible substances include, but not limited to: Acids such as nitric acid, sulfuric acid and hydrochloric acid. Any materials that are corrosive to steel.

Note that only the probe sensor inside the probe is media compatible. The outside of the pressure sensor and the pressure sensor cable are not waterproof. Do not immerse the entire sensor! The temperature sensor is also not waterproof.

Connecting the Sensors to the OM-PLPT

The temperature and pressure sensors come preconnected to the 6 position connector plug. The pressure sensor wires are color coded: black, white, green and red. The temperature probe has two white wires and does not have a polarity. To reconnect the temperature and pressure probes, use the diagram below:

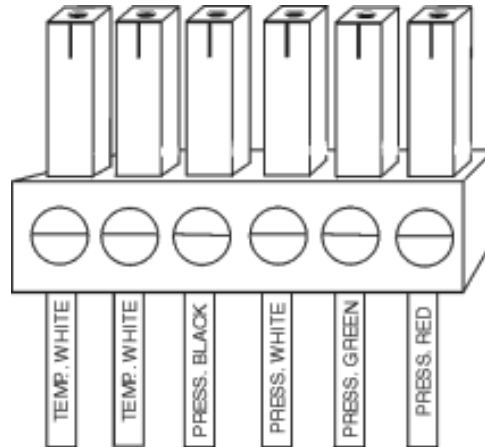

OM-PLPT Specifications

The external temperature probe standard length is 15ft. It can be extended up to 300ft.

Sample Point Capacity	10,750 data points when pressure and temperature are recorded together. 21,500 points when recording only pressure or only temperature.
Alarms	Over and under alarms for pressure and temperature probes.
Calibration	Factory calibrated for the pressure sensor. User single point offset calibration is available through software for both pressure and temperature.
Logger Operating Temperature	32°F to 140°F (0°C to 60°C) using Alkaline Battery. -40°F to 150°F (-40°C to 65°C) using Lithium Battery.
Pressure Sensor	Media compatible stainless steel sensor. 6ft cable.
Pressure Sensor Operating Temperature	32°F to 130°F (0°C to 54°C)
Time Accuracy	+/-100ppm @75°F
Pressure Range	0 to 500 PSI, 0 to 1000PSI for OM-PLPT1000
Pressure Accuracy	+/- 3 PSI, +/-5 PSI for OM-PLPT1000
Pressure Resolution	0.15 PSI, 3PSI for OM-PLPT1000
External Temperature Probe	-40°F to 150°F (-40°C to 65°C), 15ft standard. Can be extended to 300 ft.
Temperature Accuracy	+/- 1.0°F (0.5°C)
Temperature Resolution	0.1°F (0.05°C)
Dimensions	3'' x 2.5'' x 1.1'' (7.6cm x 6.4cm x 2.8cm)
Weight	2.5 Oz (71g)
Power Source	9V Alkaline or Lithium battery.
Battery Life (average use)	19 Months using Alkaline Battery. 38 Months using Lithium Battery.

OM-PLCV: AC Current, AC Voltage Logger

The OM-PLCV data logger is a precision instrument for recording AC current and AC voltage. AC current is sampled using the supplied clamp probe. The logger can store up to 21,500 data points, when it is setup to record either AC current or AC voltage (but not both). The logger can store up to 10,750 points, when it is setup to record both AC current and AC voltage.

Each logger is factory calibrated. This means that the clamp probes are not interchangeable.

Connecting the OM-PLCV to Electrical Equipment

Before connecting to any equipment follow these precautions:

- Make sure that the wires are securely attached to the connector and that no uninsulated portion of the wire is visible after the connection is made.
- Make sure that there is no strain that could pull the leads out of the OM-PLCV connector.
- Make sure that the leads will not interfere with any moving pieces of equipment and will not pull loose any wires or other connections.

To measure the voltage, connect the two voltage clip leads to the points at which the voltage is being measured.

To measure the current, place the clamp probe around the wire in which the current is being measured.

*Electrical connection to any type of operating equipment is **Dangerous!***

The OM-PLCV leads and current probe should only be connected when it has been determined that the power is off and the equipment is safe to touch.

It is suggested that you always remove the OM-PLCV voltage leads before connecting the OM-PLCV to your computer!

If you decide to connect the OM-PLCV to a voltage source while the OM-PLCV is connected to your computer, make sure to read the "Connecting the OM-PLCV to both the Computer and a Voltage Source" section for instructions.

Connecting the OM-PLCV to both the Computer and a Voltage Source

Although it is not recommended, it is sometimes necessary to connect the OM-PLCV to a voltage source while the OM-PLCV is connected to a PC, for instance, if real time monitoring is required. If both the computer and the voltage source you are connecting to are connected to wall power (as is true in most cases), an isolation transformer must be used between the voltage source and the OM-PLCV voltage inputs. An isolation transformer does not have electrical connections between the primary and secondary windings. The recommended connection is shown in the figure below.

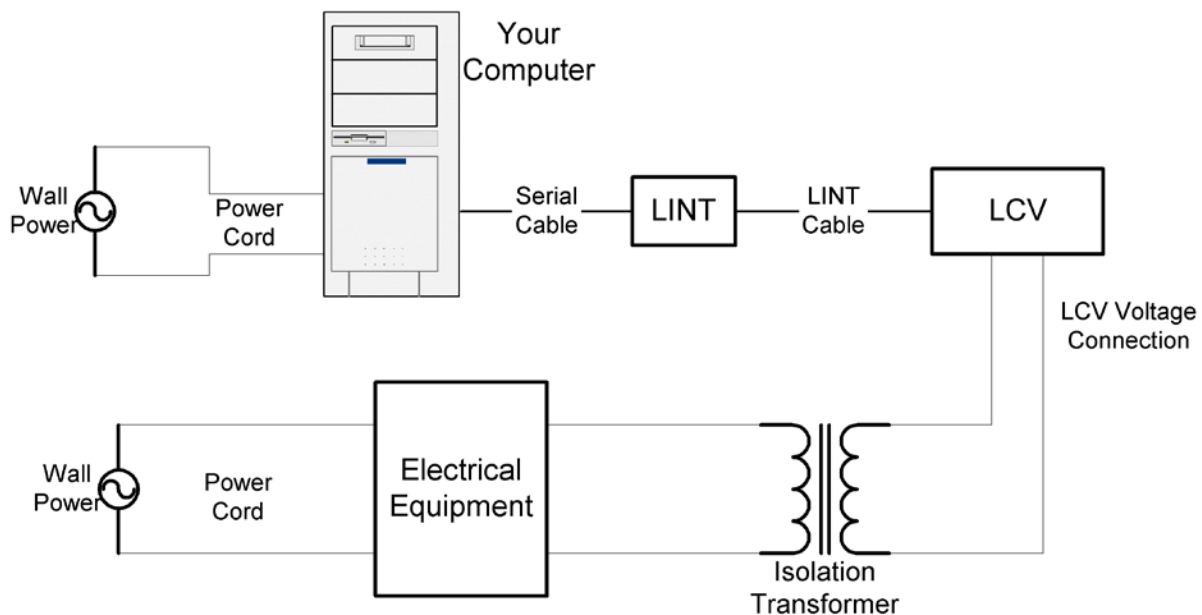

If an isolation transformer is not used, the voltage read by the OM-PLCV will not be accurate. The actual reading may be close to Actual Voltage + Line Voltage, or Actual Voltage – Line Voltage. For instance, if the OM-PLCV is connected directly to 120V line, without the Isolation Transformer, the reading may be 240V or 0V, depending on how the computer power supply is wired.

OM-PLCV Specifications

Sample Point Capacity	10,750 data points when AC current and AC voltage are recorded together. 21,500 points when recording only AC current or only AC voltage.
Alarms	Over and under alarms for AC current and AC voltage.
Calibration	AC current and AC voltage inputs are factory calibrated. User single point offset calibration is available through software for both AC current and AC voltage.
Operating Temperature	32°F to 140°F (0°C to 60°C) using Alkaline Battery. -40°F to 150°F (-40°C to 65°C) using Lithium Battery.
Time Accuracy	+/-100ppm @75°F
Relative Humidity Range	0% to 95%RH non condensing
Current Range	0 to 300 Amp AC
Current Accuracy	+/- 5%
Current Resolution	0.1 Amp AC
Voltage Range	0 to 500 Volts AC
Voltage Accuracy	+/- 1 VAC
Voltage Resolution	0.1 VAC
Dimensions	3'' x 2.5'' x 1.1'' (7.6cm x 6.4cm x 2.8cm)
Weight	2.5 Oz (71g)
Power Source	9V Alkaline or Lithium battery.
Battery Life (average use)	18 Months using Alkaline Battery. 36 Months using Lithium Battery.

OM-PL420: 4 - 20ma Current Loop Logger

The OM-PL420 data logger is a precision instrument for recording the current in a 4 – 20 ma loop. The logger can store up to 21,500 data points.

Connecting the OM-PL420 to the 4 - 20 ma Loop.

To connect the 4 – 20 ma loop to the logger, use the connector provided. Make sure to connect the positive and negative terminals correctly as shown in the figure below.

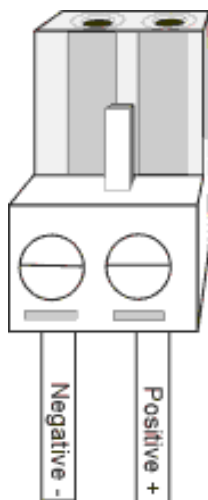

OM-PL420 Specifications

Sample Point Capacity	21,500 points.
Alarms	Over and under alarm.
Calibration	Factory calibrated. User single point offset calibration is available through software.
Operating Temperature	32°F to 140°F (0°C to 60°C) using Alkaline Battery. -40°F to 150°F (-40°C to 65°C) using Lithium Battery.
Time Accuracy	+/-100ppm @75°F
Relative Humidity Range	0% to 95%RH non condensing
Input Current Range	0ma – 40ma
Current Resolution	0.01ma
Current Accuracy	+/- 0.05 ma
Dimensions	3'' x 2.5'' x 1.1'' (7.6cm x 6.4cm x 2.8cm)
Weight	2.5 Oz (85g)
Power Source	9V Alkaline or Lithium battery.
Battery Life (average use)	21 Months using Alkaline Battery. 42 Months using Lithium Battery.

OM-PLTC: Thermocouple Temperature Logger

The OM-PLTC is a self-contained, precision instrument for recording the temperature of a thermocouple probe, and the temperature of the internal sensor. The unit can be used with J, K, E, T, R and S type thermocouples. The OM-PLTC can store up to 10,750 samples of thermocouple and internal sensor temperatures.

OM-PLTC Logging Setup

The OM-PLTC logger is setup to log like the rest of the OM-PL family. The setup procedure is described in the Setting Up The Logger To Record Data. Before the main setup window pops up, the thermocouple selection window is displayed.

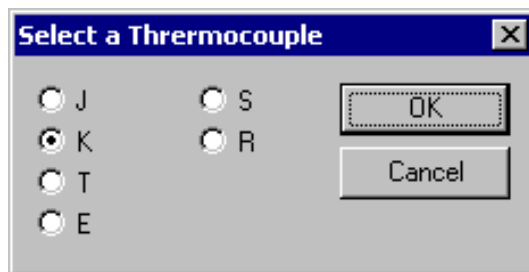

The last selected thermocouple is the default. To keep the thermocouple the same, just click OK.

To select a new thermocouple type, click on the type you are using, then click OK.

Changing the thermocouple type invalidates the thermocouple alarm thresholds stored in the logger. This is because each thermocouple uses slightly different constants for reference junction compensation. Changing the thermocouple type may greatly offset the thermocouple alarm thresholds. Whenever you change the thermocouple type, make sure to verify your thermocouple threshold settings using the Alarm Setup Window. Changing the thermocouple type does not affect the internal sensor alarm thresholds.

OM-PLTC Safety Precautions

The thermocouple logger is intended to measure both very low and very high temperatures. The OM-PLTC should only be used by qualified personnel, trained in the safe operation of electronic test equipment. Please follow the safety precautions below when operating the logger.

- As with any electrical device, working with high voltage is hazardous. Avoid connecting the thermocouple to surfaces with high voltage levels. If such a connection is possible, disconnect the thermocouple from the logger before connecting the logger to your computer. If the thermocouple probe touches a high voltage surface while the logger is connected to your computer, permanent damage to your computer may result.
- Do not touch the temperature probe when measuring excessively high or low temperatures.
- Do not attempt to measure temperatures beyond the specifications of the probe.

OM-PLTC Thermocouple Temperature Ranges

The OM-PLTC logger supports the temperature ranges summarized in the table below. These specifications are for the logger only. The probe you are using may have different specifications. Never attempt to measure temperatures beyond the specifications of the probe.

Thermocouple	Min	Max
J	-110°F (-79°C)	1350°F (730°C)
K	-220°F (-140°C)	1900°F (1040°C)
E	-75°F (-59°C)	1040°F (560°C)
T	-235°F (-148°C)	660°F (350°C)
R	32°F (0°C)	2640°F (1450°C)
S	32°F (0°C)	2640°F (1450°C)

OM-PLTC Specifications

Sample Point Capacity	10,750 points of thermocouple and ambient temperature.
Alarms	Over and under alarms for thermocouple and ambient temperature.
Calibration	Factory calibrated. User single point offset calibration is available through software for both thermocouple and ambient temperatures.
Logger Operating Temperature	32°F to 140°F (0°C to 60°C)
Storage Temperature	-40°F to 170°F (-40°C to 77°C)
Real Time Clock Accuracy	+/-100ppm @75°F
Supported Thermocouples	J, K, E, T, R, S Software selectable.
Thermocouple Connector	Industry standard miniature universal connector.
Supplied Probe	3ft FDA approved K type thermocouple probe. Probe temperature range is -40°F to 400°F (-40°C to 204°C)
Thermocouple Sensor Accuracy	Thermocouple wire dependant. The supplied probe accuracy is +/-4°F (2°C) or 0.75% of reading, whichever is greater.
Thermocouple Sensor Resolution	0.1°F (0.05°C)
Internal Sensor Temperature Accuracy	+/-2°F (1°C). For full accuracy allow a few minutes of thermal setting after connecting the thermocouple to the logger.
Internal Sensor Temperature Resolution	0.1°F (0.05°C)
Dimensions	3'' x 2.5'' x 1.1'' (7.6cm x 6.4cm x 2.8cm)
Weight	2.5 Oz (71g)
Power Source	9V Alkaline or Lithium battery (Not Included).
Battery Life (average use)	20 Months using Alkaline Battery. 40 Months using Lithium Battery.

WARRANTY/DISCLAIMER

OMEGA ENGINEERING, INC. warrants this unit to be free of defects in materials and workmanship for a period of **13 months** from date of purchase. OMEGA's WARRANTY adds an additional one (1) month grace period to the normal **one (1) year product warranty** to cover handling and shipping time. This ensures that OMEGA's customers receive maximum coverage on each product.

If the unit malfunctions, it must be returned to the factory for evaluation. OMEGA's Customer Service Department will issue an Authorized Return (AR) number immediately upon phone or written request. Upon examination by OMEGA, if the unit is found to be defective, it will be repaired or replaced at no charge. OMEGA's WARRANTY does not apply to defects resulting from any action of the purchaser, including but not limited to mishandling, improper interfacing, operation outside of design limits, improper repair, or unauthorized modification. This WARRANTY is VOID if the unit shows evidence of having been tampered with or shows evidence of having been damaged as a result of excessive corrosion; or current, heat, moisture or vibration; improper specification; misapplication; misuse or other operating conditions outside of OMEGA's control. Components in which wear is not warranted, include but are not limited to contact points, fuses, and triacs.

OMEGA is pleased to offer suggestions on the use of its various products. However, OMEGA neither assumes responsibility for any omissions or errors nor assumes liability for any damages that result from the use of its products in accordance with information provided by OMEGA, either verbal or written. OMEGA warrants only that the parts manufactured by the company will be as specified and free of defects. OMEGA MAKES NO OTHER WARRANTIES OR REPRESENTATIONS OF ANY KIND WHATSOEVER, EXPRESSED OR IMPLIED, EXCEPT THAT OF TITLE, AND ALL IMPLIED WARRANTIES INCLUDING ANY WARRANTY OF MERCHANTABILITY AND FITNESS FOR A PARTICULAR PURPOSE ARE HEREBY DISCLAIMED. LIMITATION OF LIABILITY: The remedies of purchaser set forth herein are exclusive, and the total liability of OMEGA with respect to this order, whether based on contract, warranty, negligence, indemnification, strict liability or otherwise, shall not exceed the purchase price of the component upon which liability is based. In no event shall OMEGA be liable for consequential, incidental or special damages.

CONDITIONS: Equipment sold by OMEGA is not intended to be used, nor shall it be used: (1) as a "Basic Component" under 10 CFR 21 (NRC), used in or with any nuclear installation or activity; or (2) in medical applications or used on humans. Should any Product(s) be used in or with any nuclear installation or activity, medical application, used on humans, or misused in any way, OMEGA assumes no responsibility as set forth in our basic WARRANTY/DISCLAIMER language, and, additionally, purchaser will indemnify OMEGA and hold OMEGA harmless from any liability or damage whatsoever arising out of the use of the Product(s) in such a manner.

RETURN REQUESTS/INQUIRIES

Direct all warranty and repair requests/inquiries to the OMEGA Customer Service Department. BEFORE RETURNING ANY PRODUCT(S) TO OMEGA, PURCHASER MUST OBTAIN AN AUTHORIZED RETURN (AR) NUMBER FROM OMEGA'S CUSTOMER SERVICE DEPARTMENT (IN ORDER TO AVOID PROCESSING DELAYS). The assigned AR number should then be marked on the outside of the return package and on any correspondence.

The purchaser is responsible for shipping charges, freight, insurance and proper packaging to prevent breakage in transit.

FOR **WARRANTY** RETURNS, please have the following information available BEFORE contacting OMEGA:

1. Purchase Order number under which the product was PURCHASED,
2. Model and serial number of the product under warranty, and
3. Repair instructions and/or specific problems relative to the product.

FOR **NON-WARRANTY** REPAIRS, consult OMEGA for current repair charges. Have the following information available BEFORE contacting OMEGA:

1. Purchase Order number to cover the COST of the repair,
2. Model and serial number of the product, and
3. Repair instructions and/or specific problems relative to the product.

OMEGA's policy is to make running changes, not model changes, whenever an improvement is possible. This affords our customers the latest in technology and engineering.

OMEGA is a registered trademark of OMEGA ENGINEERING, INC.

© Copyright 2015 OMEGA ENGINEERING, INC. All rights reserved. This document may not be copied, photocopied, reproduced, translated, or reduced to any electronic medium or machine-readable form, in whole or in part, without the prior written consent of OMEGA ENGINEERING, INC.

Where Do I Find Everything I Need for Process Measurement and Control? **OMEGA...Of Course!** *Shop online at omega.comSM*

TEMPERATURE

- Thermocouple, RTD & Thermistor Probes, Connectors, Panels & Assemblies
- Wire: Thermocouple, RTD & Thermistor
- Calibrators & Ice Point References
- Recorders, Controllers & Process Monitors
- Infrared Pyrometers

PRESSURE, STRAIN AND FORCE

- Transducers & Strain Gages
- Load Cells & Pressure Gages
- Displacement Transducers
- Instrumentation & Accessories

FLOW/LEVEL

- Rotameters, Gas Mass Flowmeters & Flow Computers
- Air Velocity Indicators
- Turbine/Paddlewheel Systems
- Totalizers & Batch Controllers

pH/CONDUCTIVITY

- pH Electrodes, Testers & Accessories
- Benchtop/Laboratory Meters
- Controllers, Calibrators, Simulators & Pumps
- Industrial pH & Conductivity Equipment

DATA ACQUISITION

- Data Acquisition & Engineering Software
- Communications-Based Acquisition Systems
- Plug-in Cards for Apple, IBM & Compatibles
- Data Logging Systems
- Recorders, Printers & Plotters

HEATERS

- Heating Cable
- Cartridge & Strip Heaters
- Immersion & Band Heaters
- Flexible Heaters
- Laboratory Heaters

ENVIRONMENTAL MONITORING AND CONTROL

- Metering & Control Instrumentation
- Refractometers
- Pumps & Tubing
- Air, Soil & Water Monitors
- Industrial Water & Wastewater Treatment
- pH, Conductivity & Dissolved Oxygen Instruments