

DFE322520F-1R5M#

“#” indicates a package specification code.

1210 (3225) inch (mm) size, Large Current, Low DC Resistance Type



< List of part numbers with package codes >

DFE322520F-1R5M=P2

Appearance & Shape

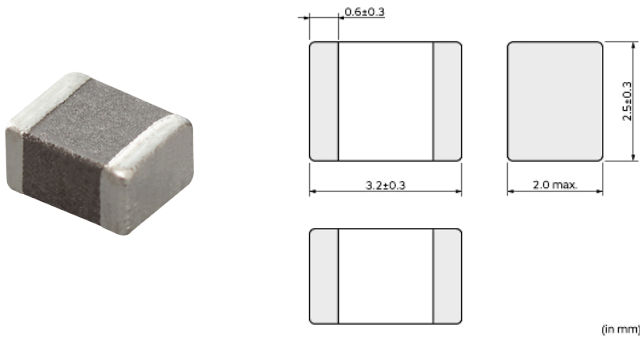

References

Packaging	Specifications	Standard Packing Quantity
=P2	180Embossed Tape	2000

Mass (typ.)	
1 piece	0.0913g

Notices

Rated current (I_{sat}) is specified when the decrease of the initial inductance value at 30%. Rated current (I_{temp}) is specified when temperature of the inductor is raised 40°C by DC current.

Attention

- 1.This datasheet is downloaded from the website of Murata Manufacturing Co., Ltd. Therefore, it's specifications are subject to change or our products in it may be discontinued without advance notice. Please check with our sales representatives or product engineers before ordering.
- 2.This datasheet has only typical specifications because there is no space for detailed specifications. Therefore, please review our product specifications or consult the approval sheet for product specifications before ordering.

DFE322520F-1R5M#

“#” indicates a package specification code.



Specifications

L size	3.2±0.3mm
W size	2.5±0.3mm
T size	2.0mm
Size code inch (mm)	1210 (3225)
Inductance	1.5μH±20%
Inductance Test Frequency	1MHz
Rated current (Isat) (Based on Inductance change)	5200mA
Rated current (Itemp) (Based on Temperature rise)	4000mA
Max. of DC resistance	0.029Ω
Operating Temperature Range (Self-temperature rise is included)	-40°C to 125°C
Class of magnetic shield	Metal Alloy
Absolute maximum voltage	20Vdc
Brand	Murata
Series	DFE322520F

Attention

- 1.This datasheet is downloaded from the website of Murata Manufacturing Co., Ltd. Therefore, it's specifications are subject to change or our products in it may be discontinued without advance notice. Please check with our sales representatives or product engineers before ordering.
- 2.This datasheet has only typical specifications because there is no space for detailed specifications. Therefore, please review our product specifications or consult the approval sheet for product specifications before ordering.

DFE322520F-1R5M#

"#" indicates a package specification code.

Characteristic Data

The charts below may show another part number which shares its characteristics.

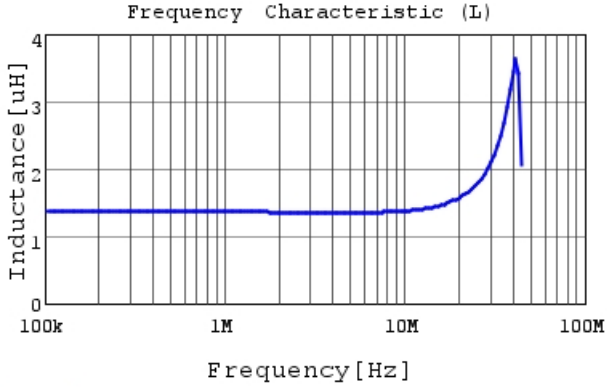

DFE322520F-1R5M L

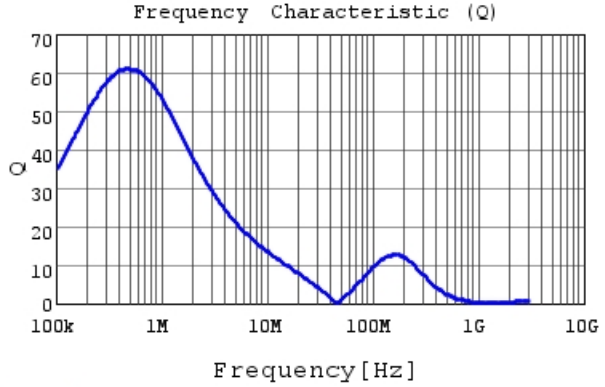

DFE322520F-1R5M Q

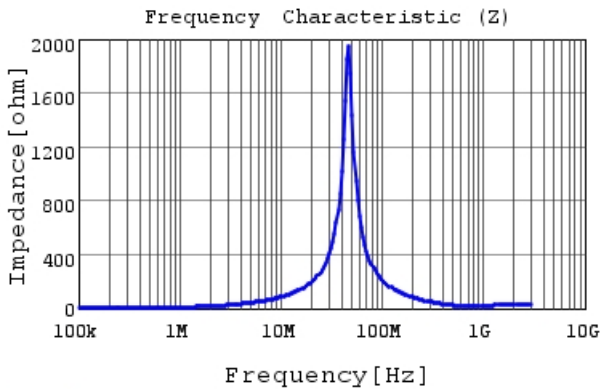

DFE322520F-1R5M |Z|

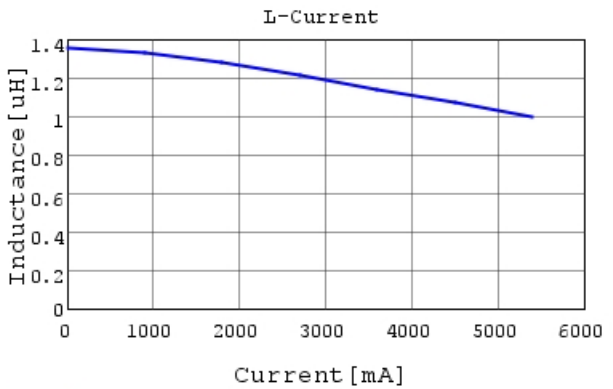

DFE322520F-1R5M L-Current 20degC

Attention

- 1.This datasheet is downloaded from the website of Murata Manufacturing Co., Ltd. Therefore, it's specifications are subject to change or our products in it may be discontinued without advance notice. Please check with our sales representatives or product engineers before ordering.
- 2.This datasheet has only typical specifications because there is no space for detailed specifications. Therefore, please review our product specifications or consult the approval sheet for product specifications before ordering.

DFE322520F-1R5M#

“#” indicates a package specification code.

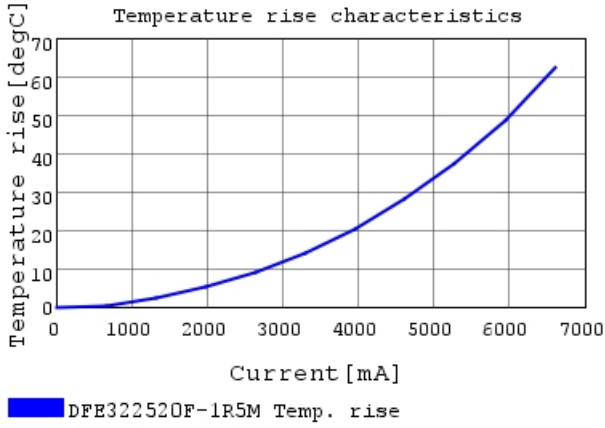

Attention

- 1.This datasheet is downloaded from the website of Murata Manufacturing Co., Ltd. Therefore, it's specifications are subject to change or our products in it may be discontinued without advance notice. Please check with our sales representatives or product engineers before ordering.
- 2.This datasheet has only typical specifications because there is no space for detailed specifications. Therefore, please review our product specifications or consult the approval sheet for product specifications before ordering.