

[Amplifier Built-in] [Multi-voltage]
Adjustable Range Reflective
Photoelectric Sensor

EQ-500 SERIES



EQ-500 SERIES



Long range sensing capability to 2.5 m **8.202 ft** Stable sensing unaffected by color or material

Long sensing range

An adjustable range to 2.5 m **8.202 ft** allows plenty of space for installation.
1 m **3.281 ft** sensing range type also available. Adjust the volume easily to suit your needs when using at close range.

Hardly affected by background objects

Because the sensor doesn't detect objects outside the preset sensing field by using the 2-segment photodiode adjustable range system, it will not malfunction even if someone walks behind the sensing object or machines or conveyors are in the background.

Note: Please note that malfunction may occur when there are specular objects or objects with a mirror-like surface in the background.

[Refer to p.7 "Mounting" of "PRECAUTIONS FOR PROPER USE" section.]

Impervious to variations color or angle

The optical system has been optimized. Since the sensor is hardly influenced at all by angles or the gloss of objects compared to the previous model, it is possible to detect both white objects and black objects at almost a constant distance.

[The difference in sensing range between white non-glossy paper and gray non-glossy paper (lightness: 5) is approx 5% when set at a distance of 2 m **6.562 ft**.]

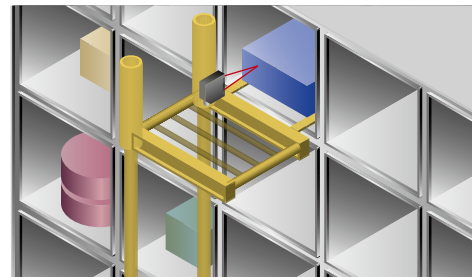

MOUNTING

Convenient terminal block type

Cabling enabled by way of a terminal block that eliminates waste.

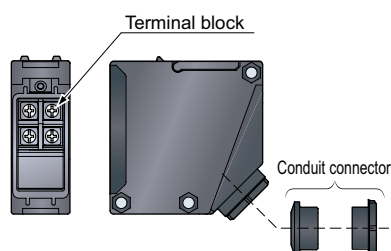

OPERABILITY

An easy to set adjuster with indicator

Equipped with a 2-turn adjuster with indicator, making it easy to set for short or long distances.

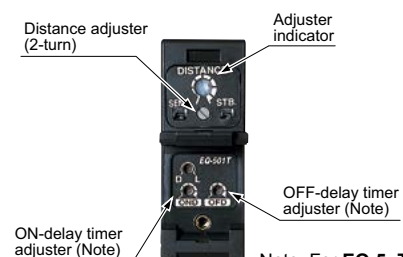

Note: For EQ-5□T only.

APPLICATIONS**Level check within the hopper**

The distance to the object can be set to enable residual amount sensing in the hopper regardless of color.

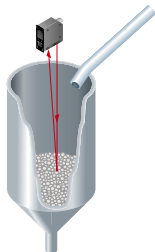
**Confirmation of the passage of packages on a conveyor belt**

Can accurately detect packages even if they vary in size and color.

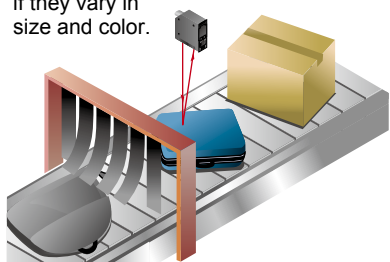
**VARIETIES****Equipped with both NPN and PNP outputs** EQ-51□

We've added a DC-voltage type with NPN and PNP transistor outputs all in one sensor. Its BGS/FGS function controls any background effects for more stable sensing.

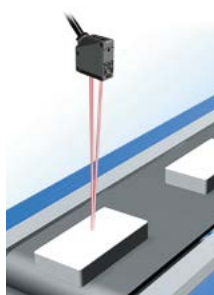
**Multi-voltage**

EQ-50□

Because it can function with 24 to 240 V AC and 12 to 240 V DC, almost any power supply anywhere in the world will do.

Convenient timer function models

Types with an ON-delay/OFF-delay timer available. OFF-delay, e.g. useful when the response of the connected device is slow, ON-delay, e.g. useful to detect objects that take a long time to move.

- Operation: ON-delay, OFF-delay
- Timer period: 0.1 to 5 sec.
(individual setting possible)

FUNCTIONS**BGS/FGS functions make even the most challenging settings possible!**

EQ-51□

The BGS function is best suited for background not present

When object and background are separated
BGS (Background suppression) function
The sensor judges that an object is present when light is received at position A of the light-receiving element (2-segment element). This is useful if the object and background are far apart. Not affected if the background color changes or someone passes behind the conveyor.

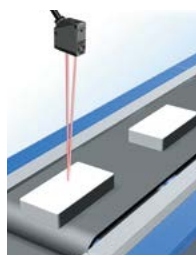
The FGS function is best suited for background present

When object and background are close together
When the object is glossy or uneven
FGS (Foreground suppression) function
The sensor judges that no object is present when light is received at position B of the light receiving element (2-segment element) (The conveyor is detected). This function is useful if the object and the background are close together or if the object is glossy or uneven. However, sensing is impossible if there is no background (conveyor, etc.).

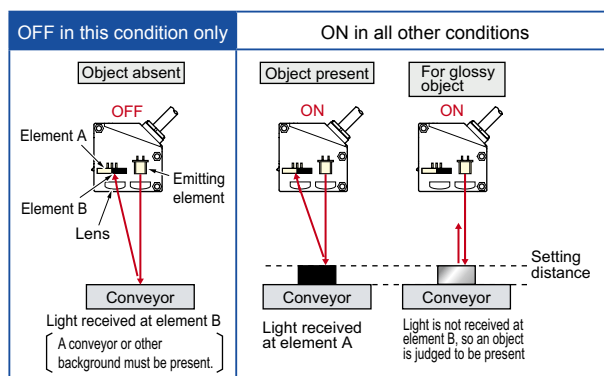
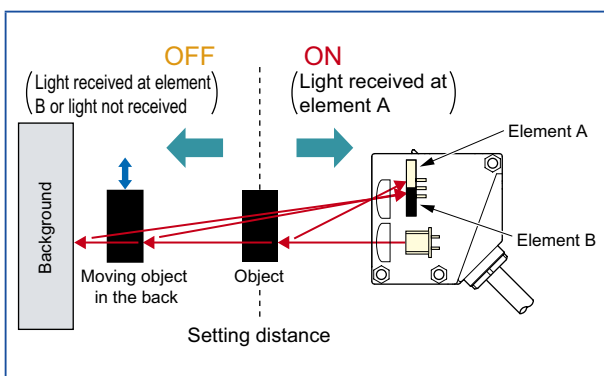

Note: Refer to "BGS/FGS function (p.8)" of "PRECAUTIONS FOR PROPER USE" for operation of BGS/FGS function.

ENVIRONMENTAL RESISTANCE

Little affected by contamination on lens

Even if the lens surface gets somewhat dirty from dust particles, there is very little change in the operation field, by usage adjustable range system.

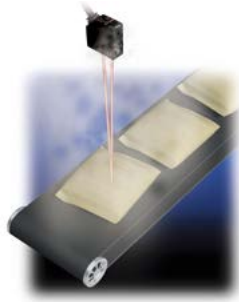

Waterproof

The sensors features an IP67 rating to allow their use in process lines where water is used or splashed.



Note: If water splashes on the sensor during sensing operation, it may sense water as an object.

ORDER GUIDE

Type	Appearance	Sensing range	Model No.	Supply voltage	Output	Timer function
Multi-voltage		 0.1 to 2.5 m 0.328 to 8.202 ft	EQ-501	24-240 V AC ±10 % or 12 to 240 V DC ±10 %	Relay contact 1a	—
			EQ-501T			ON-delay/OFF-delay timer (Timer period: 0.1 to 5 sec.)
		0.1 to 1.0 m 0.328 to 3.281 ft	EQ-502			—
			EQ-502T			ON-delay/OFF-delay timer (Timer period: 0.1 to 5 sec.)
DC-voltage		 0.1 to 2.5 m 0.328 to 8.202 ft	EQ-511	12 to 24 V DC ±10 %	NPN open-collector transistor PNP open-collector transistor (Equipped with) 2 outputs	—
			EQ-511T			ON-delay/OFF-delay timer (Timer period: 0.1 to 5 sec.)
		0.1 to 1.0 m 0.328 to 3.281 ft	EQ-512			—
			EQ-512T			ON-delay/OFF-delay timer (Timer period: 0.1 to 5 sec.)

OPTION

Designation	Model No.	Description
Sensor mounting bracket	MS-EQ5-01	Foot/back angled mounting bracket

Sensor mounting bracket

• MS-EQ5-01

Two M5 (length 30 mm 1.181 in) screws with washers and two nuts are attached.

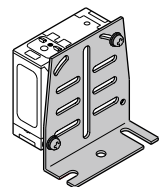

SPECIFICATIONS

Item	Type Model No.	Multi-voltage				DC-voltage			
		With timer		With timer		With timer		With timer	
		EQ-501	EQ-501T	EQ-502	EQ-502T	EQ-511	EQ-511T	EQ-512	EQ-512T
CE marking directive compliance		Low Voltage Directive, EMC Directive, RoHS Directive				EMC Directive, RoHS Directive			
Adjustable range (Note 2,3)		0.2 to 2.5 m 0.656 to 8.202 ft		0.2 to 1.0 m 0.656 to 3.281 ft		0.2 to 2.5 m 0.656 to 8.202 ft		0.2 to 1.0 m 0.656 to 3.281 ft	
Sensing range (at max. setting distance) (Note 3)		0.1 to 2.5 m 0.328 to 8.202 ft		0.1 to 1.0 m 0.328 to 3.281 ft		0.1 to 2.5 m 0.328 to 8.202 ft		0.1 to 1.0 m 0.328 to 3.281 ft	
Hysteresis (Note 3)		10 % or less of operation distance							
Supply voltage		24-240 V AC ± 10 % or 12 to 240 V DC ± 10 % Ripple P-P 10 % or less				12 to 24 V DC ± 10 % Ripple P-P 10 % or less			
Power / Current consumption		AC: 4 VA or less DC: 3 W or less	AC: 5 VA or less DC: 4 W or less	AC: 4 VA or less DC: 3 W or less	AC: 5 VA or less DC: 4 W or less	45 mA or less			
Output		Relay contact 1a <ul style="list-style-type: none"> Switching capacity: 250 V AC 3 A (resistive load) 30 V DC 3 A (resistive load) Electrical life: 100,000 or more switching operations (switching frequency 1,200 operations/hour) Mechanical life: 50 million or more switching operations (switching frequency 18,000 operations/hour) 				NPN open-collector transistor <ul style="list-style-type: none"> Maximum sink current: 100 mA Applied voltage: 30 V DC or less (between output and 0 V) Residual voltage: 1 V or less (at 100 mA sink current) 0.4 V or less (at 16 mA sink current) PNP open-collector transistor <ul style="list-style-type: none"> Maximum source current: 100 mA Applied voltage: 30 V DC or less (between output and +V) Residual voltage: 1 V or less (at 100 mA source current) 0.4 V or less (at 16 mA source current) 			
	Output operation	Switchable either Detection-ON or Detection-OFF							
	Short-circuit protection	—				Incorporated			
Response time		20 ms or less (For EQ-50□T depends on the setting timer period)				2 ms or less (For EQ-51□T depends on the setting timer period)			
Operation indicator		Orange LED (lights up when the output is ON)							
Stability indicator		Green LED (lights up under stable operating condition)							
Distance adjuster		2-turn mechanical adjuster with indicator							
Sensing mode		—				Switchable either BGS or FGS function			
Timer function		—	Incorporated with variable (0.1 to 5 sec.) ON-delay/ OFF-delay timer	—	Incorporated with variable (0.1 to 5 sec.) ON-delay/ OFF-delay timer	—	Incorporated with variable (0.1 to 5 sec.) ON-delay/ OFF-delay timer	—	Incorporated with variable (0.1 to 5 sec.) ON-delay/ OFF-delay timer
Automatic interference prevention function		Incorporated (Note 4)							
Environmental resistance	Protection	IP67 (IEC)							
	Ambient temperature	-25 to +55 °C -13 to +131 °F (No dew condensation or icing allowed), Storage: -30 to +70 °C -22 to +158 °F							
	Ambient humidity	35 to 85 % RH, Storage: 35 to 85 % RH							
	Ambient illuminance	Incandescent light: 3,000 lx or less at the light-receiving face							
	Voltage withstandability	2,000 V AC for one min. among supply terminals, non-supply metal parts and relay contact output terminals, 1,000 V AC for one min. between relay contacts				1,000 V AC for one min. between all supply terminals connected together and enclosure			
	Insulation resistance	100 M Ω , or more, with 500 V DC megger among supply terminals, non-supply metal parts and relay contact output terminals as well as between relay contacts				20 M Ω , or more, with 250 V DC megger between all supply terminals connected together and enclosure			
	Vibration resistance	10 to 55 Hz frequency, 1.5 mm 0.059 in double amplitude in X, Y and Z directions for two hours each							
	Shock resistance	500 m/s ² acceleration (50 G approx.) in X, Y and Z directions three times each							
Emitting element		Infrared LED (Peak emission wavelength: 855 nm 0.034 mil , modulated)							
Receiving element		2-segment photodiode							
Material		Enclosure: ABS, Front cover: Polycarbonate, Display cover: Polycarbonate							
Connection method		Screw-on terminal connection							
Cable		Suitable for round cable $\phi 9$ to $\phi 11$ mm $\phi 0.354$ to $\phi 0.433$ in							
Cable length		Total length up to 100 m 328.084 ft is possible with 0.3 mm ² , or more, cabtyre cable.							
Weight		Net weight: 100 g approx.				Net weight: 85 g approx.			
Accessory		Adjusting screwdriver: 1 pc.							

Notes: 1) Where measurement conditions have not been specified precisely, the conditions used were an ambient temperature of +23 °C **+73.4 °F**.

2) The adjustable range stands for the maximum sensing range which can be set with the distance adjuster. The sensor can also detect an object 0.1 m **0.328 ft**, or more, away.

3) The adjustable range, sensing range and hysteresis are specified for white non-glossy paper (200 × 200 mm **7.874 × 7.874 in**) as the object.

4) Note that the detection may be unstable depending on the mounting conditions or the sensing object. In the state that this product is mounted, be sure to check the operation with the actual sensing object. Refer to "Automatic interference function (p.7)" of "PRECAUTIONS FOR PROPER USE" for details.

I/O CIRCUIT AND WIRING DIAGRAMS

EQ-501(T) EQ-502(T)

I/O circuit diagram

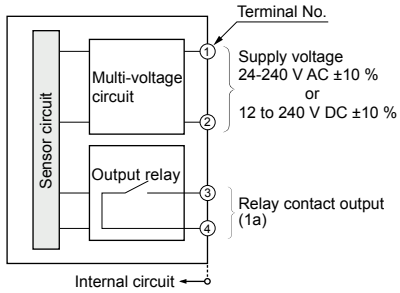

Terminal arrangement diagram

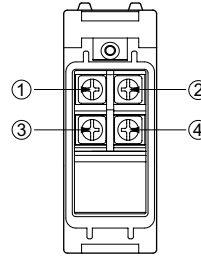

EQ-511(T) EQ-512(T)

I/O circuit diagram

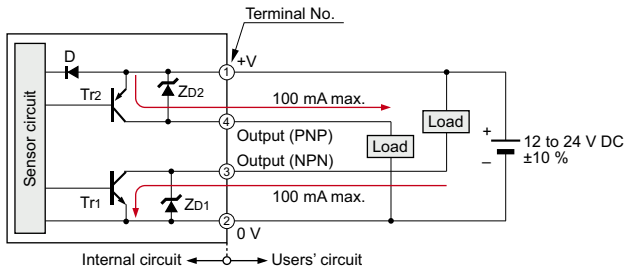

Terminal arrangement diagram

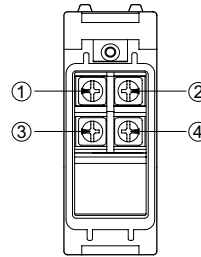

Symbols ... D: Reverse supply polarity protection diode
 ZD1, ZD2: Surge absorption zener diode
 Tr1: NPN output transistor
 Tr2: PNP output transistor

SENSING CHARACTERISTICS (TYPICAL)

EQ-501(T) EQ-511(T)

Sensing fields

• Setting distance: 1 m 3.281 ft

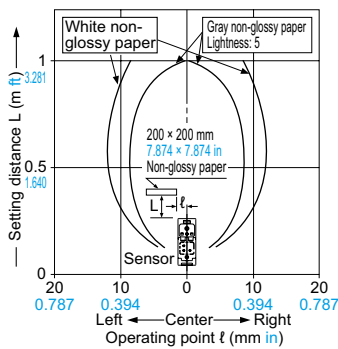

• Setting distance: 2.5 m 8.202 ft

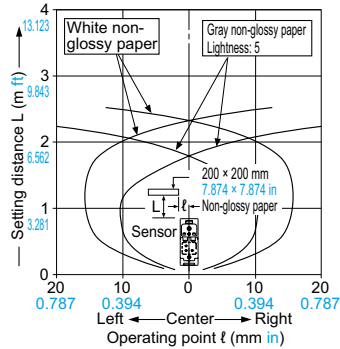

Correlation between material

(200 × 200 mm 7.874 × 7.874 in) and sensing range

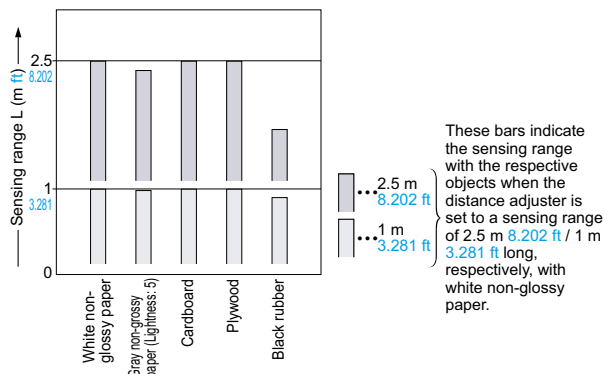

These bars indicate the sensing range with the respective objects when the distance adjuster is set to a sensing range of 2.5 m 8.202 ft / 1 m 3.281 ft long, respectively, with white non-glossy paper.

Correlation between color

(200 × 200 mm 7.874 × 7.874 in non-glossy paper) and sensing range

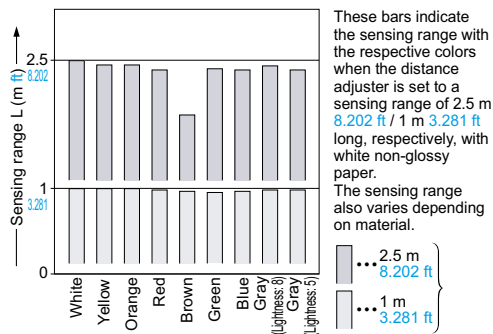

These bars indicate the sensing range with the respective colors when the distance adjuster is set to a sensing range of 2.5 m 8.202 ft / 1 m 3.281 ft long, respectively, with white non-glossy paper. The sensing range also varies depending on material.

Emitted beam

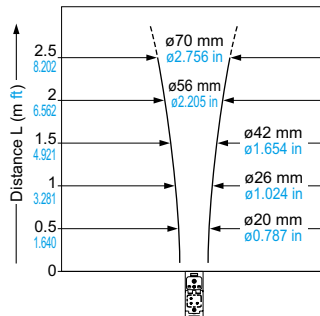

Correlation between sensing object size and sensing range

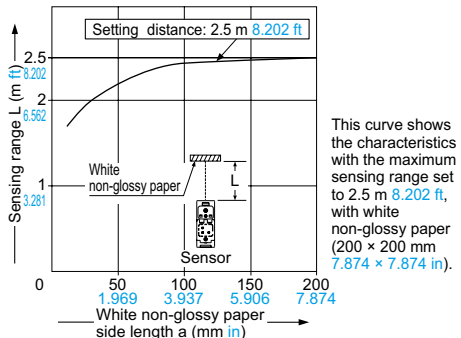

This curve shows the characteristics with the maximum sensing range set to 2.5 m 8.202 ft, with white non-glossy paper (200 × 200 mm 7.874 × 7.874 in).

SENSING CHARACTERISTICS (TYPICAL)

EQ-502 (T) EQ-512 (T)

Sensing fields

• Setting distance: 0.5 m 1.640 ft

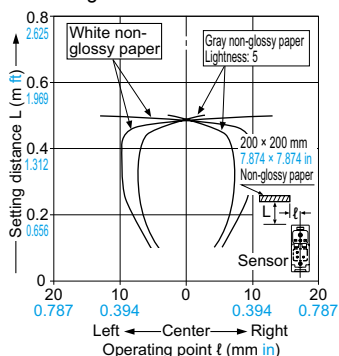

• Setting distance: 1 m 3.281 ft

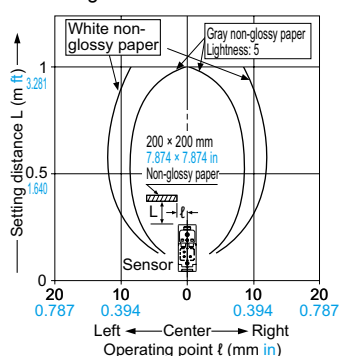

Correlation between material

(200 × 200 mm 7.874 × 7.874 in) and sensing range

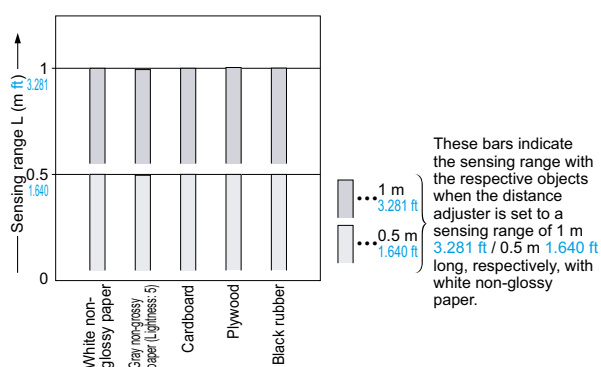

Correlation between color (200 × 200 mm 7.874 × 7.874 in non-glossy paper) and sensing range

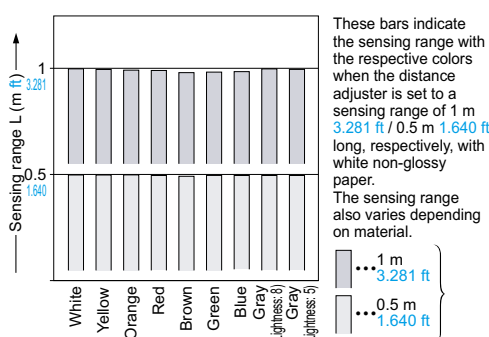

Emitted beam

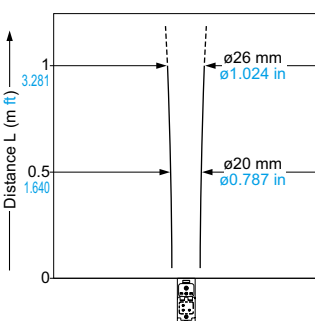

Correlation between sensing object size and sensing range

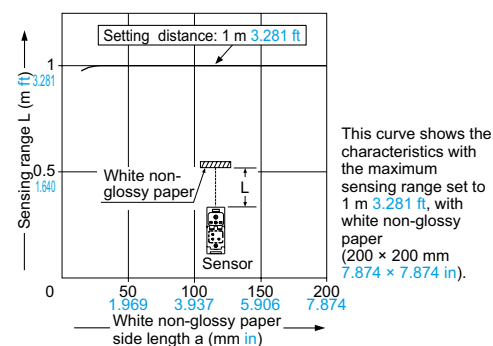

PRECAUTIONS FOR PROPER USE



- Never use this product as a sensing device for personnel protection.
- In case of using sensing devices for personnel protection, use products which meet laws and standards, such as OSHA, ANSI or IEC etc., for personnel protection applicable in each region or country.

Mounting

- The tightening torque should be 0.8 N·m or less.
- Care must be taken regarding the sensor mounting direction with respect to the object's direction of movement.

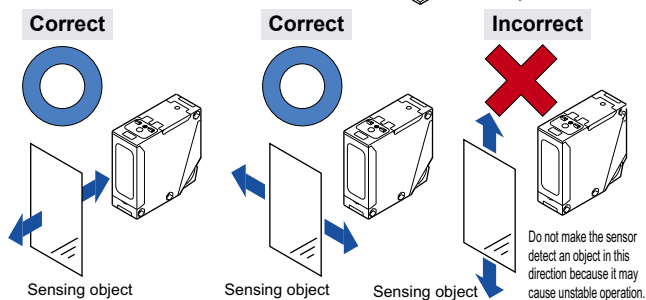
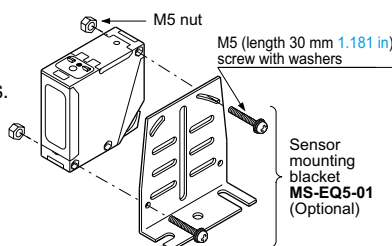

- When detecting a specular object (aluminum or copper foil, etc.) or an object having a glossy surface or coating, please note that there are cases when the object may not be detected due to a change in angle, wrinkles on the object surface, etc.
- If a specular body is present in the background, faulty operation may be caused due to a small change in the angle of the background body. In that case, install the sensor at an inclination and confirm the operation with the actual sensing object.

- When a specular body is present below the sensor, use the sensor by tilting it slightly upwards to avoid faulty operation.

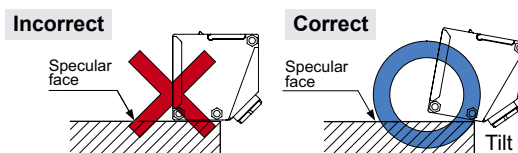

- This product is not easily affected by the reflected light intensity since this sensor is the adjustable range reflective type. When the reflected light intensity is remarkably low, the sensing range may be affected. In that case, mount the sensor, while checking light-up of the stable indicator (green).
- The mounting screws of the terminal cover and VR cover should certainly be tightened to maintain water-resistance; the tightening torque of the screws should be 0.3 to 0.5 N·m.

Automatic interference prevention function

- When the sensors are mounted closely, use them in the interference prevented area, as shown below.

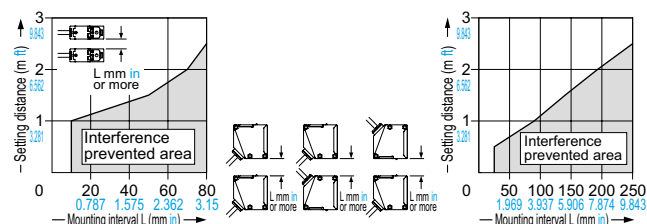

- Note that the detection may be unstable depending on the mounting conditions or the sensing object to be used. In the state that this product is mounted, be sure to check the operation with the actual sensing object to be used.

PRECAUTIONS FOR PROPER USE

Wiring

- Check all wiring before applying power since incorrect wiring may damage the internal circuit. Also, carefully tighten the terminal screws so that the wires of adjacent terminals do not touch.
- The mounting hole for the terminal cover fixing screws inclines 70 degrees to the terminal cover, as shown in the figure below. To avoid damaging this product or screw, take care when tightening or loosening a screw.

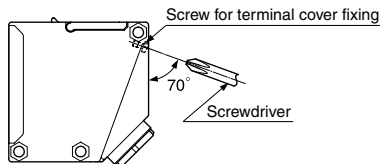

- To maintain water-resistance, the cable should have an outer diameter between $\varnothing 9$ to $\varnothing 11$ mm $\varnothing 0.354$ to $\varnothing 0.433$ in with a smooth covering material that allows the attached conduit connector to be securely tightened; the tightening torque of the screw should be of 1.5 to 2.0 N·m.
- If an external surge voltage exceeding 4 kV is impressed (DC-voltage type: 1 kV), the internal circuit will be damaged, and a surge suppressing element should be used.
- Prepare the cable end as shown below.

Conduit connector construction and cabling

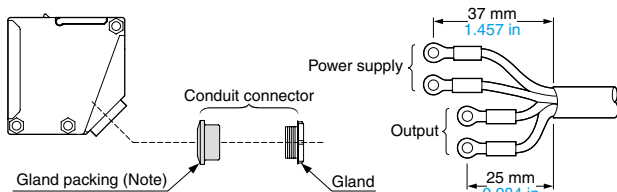

Note: When assembling the conduit connector, pay attention to the direction of the gland packing. Furthermore, in order to maintain water-resistance, fit the gland packing such that the seating surface of the gland packing contacts the packing holder part of the terminal cover evenly.

- The size of conduit is M20 × 1.5 mm 0.787 in.
- If pressure terminals are to be used, affix the connected pressure terminals to a terminal (M3.5 screw).

Dimensions of the suitable crimp terminals

(Unit: mm in)

Round type	Y-shaped type

Note: Use crimp terminals with insulating sleeves.

Recommended crimp terminal: Nominal size 1.25×3.5 0.049×0.138 .

- The tightening torque for the terminal screws should be 0.3 to 0.5 N·m.

Part description

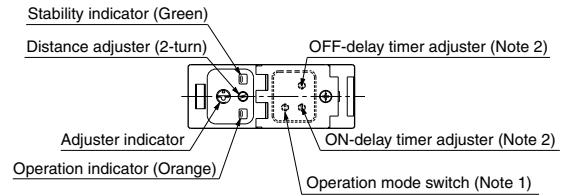

Notes: 1) The operation mode switch of the DC-voltage type is the DIP switch. Refer to "DC-voltage type" of "Operation mode switch" for details.
2) Incorporated on EQ-5□T only.

Operation mode switch

Multi-voltage type (L-ON/D-ON mode only)

Operation mode switch	Description
	Detection-ON mode is obtained when the switch is turned fully clockwise (L side).
	Detection-OFF mode is obtained when the switch is turned fully counterclockwise (D side).

Note: Turn the operation mode switch gradually and lightly with the attached screwdriver. Turning with excessive strength will cause damage to the adjuster.

DC-voltage type

L-ON/D-ON mode	→ L		D
BGS/FGS mode	→ BGS		FGS
Timer mode	→ OFF		Timer ON
Not used	→ N.C.		N.C.

BGS/FGS function (DC-voltage type only)

- DC-voltage type sensor incorporates BGS/FGS function. Select either the BGS or FGS function depending on the positions of the background and sensing object.
- BGS/FGS function is set with the operation mode switch.
- FGS function is used when the sensing object contacts the background (conveyor, etc).
- Depends on a selection of either BGS or FGS function, the output operation changes as follows.

		Detectable range		Setting distance		Non-detectable area	
BGS	L-ON		ON		OFF		ON
	D-ON		ON		OFF		OFF
FGS	L-ON		ON		OFF		OFF
	D-ON		ON		OFF		ON

PRECAUTIONS FOR PROPER USE

Timer function (EQ-5□T only)

- **EQ-5□T** incorporates an OFF-delay timer, which is useful when the response of the connected device is slow, etc., and an ON-delay timer, which is useful for detecting objects that move slowly, for example.
- The OFF-delay and ON-delay timers can be used simultaneously.
- For DC-voltage type, set the DIP switch for the timer mode to 'Timer ON' side.

Time chart

Operation	Sensing condition	Detection	Non-detection
Detection normal operation	[Pulse]	ON	OFF
Detection ON-delay	[Pulse]	ON (with delay T)	OFF
Detection OFF-delay	[Pulse]	ON	OFF (with delay T)
Detection ON/OFF-delay	[Pulse]	ON (with delay T)	OFF (with delay T)
Non-detection normal operation	[Pulse]	OFF	ON
Non-detection ON-delay	[Pulse]	OFF	ON (with delay T)
Non-detection OFF-delay	[Pulse]	OFF	ON (with delay T)
Non-detection ON/OFF-delay	[Pulse]	OFF (with delay T)	ON (with delay T)

Timer period: T = 0.1 to 5 sec. (variable)

Stability indicator

- Since the **EQ-500** series uses a 2-segment photodiode as its receiving element, and sensing is done based on the difference in the incident beam angle of the reflected beam from the sensing object, the output and the operation indicator (orange) operate according to the object distance. Furthermore, the stability indicator (green) shows the margin of the setting distance.

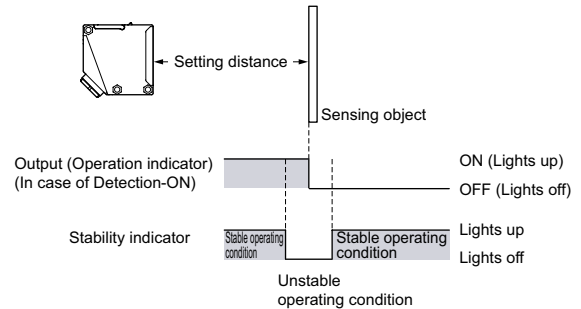

Others

- Do not use during the initial transient time (50 ms) after the power supply is switched on.
- Its distance adjuster is mechanically operated. Do not drop; avoid other shocks.

DIMENSIONS (Unit: mm in)

The CAD data can be downloaded from our website.

EQ-501(T) EQ-502(T) EQ-511(T) EQ-512(T)

Sensor

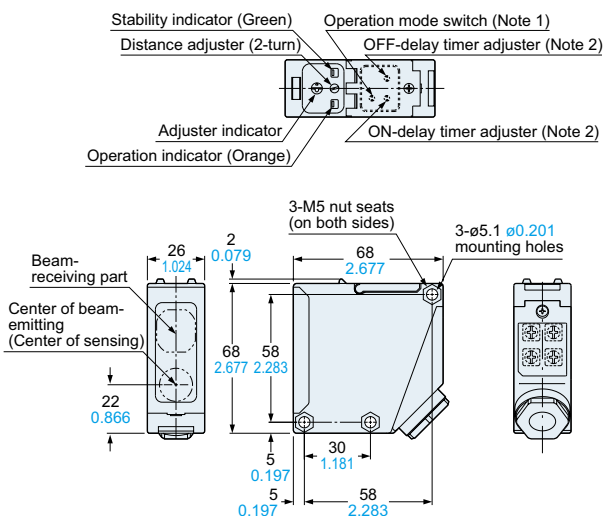

Notes: 1) The operation mode switch of the DC-voltage type is the DIP switch.
2) For **EQ-5□T** only.

Assembly dimensions with sensor mounting bracket MS-EQ-01 (Optional) (Foot angled mounting)

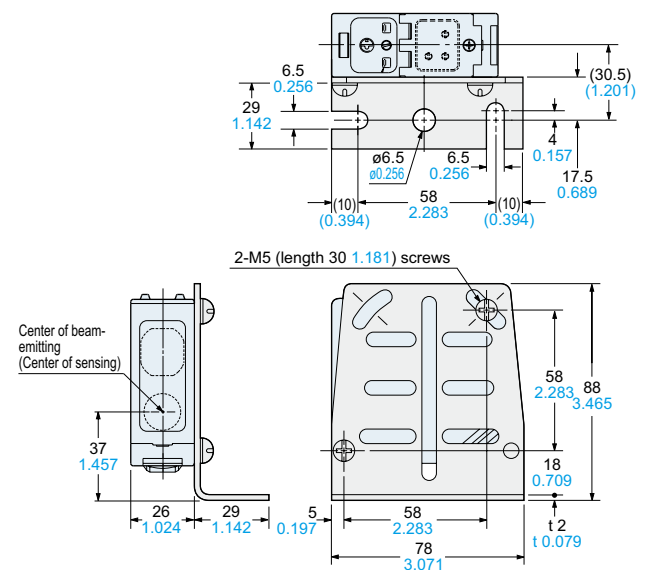

Material: Cold rolled carbon steel (SPCC)

Two M5 (length 30 mm 1.181 in) screws with washers and two nuts are attached.

Disclaimer

The applications described in the catalog are all intended for examples only. The purchase of our products described in the catalog shall not be regarded as granting of a license to use our products in the described applications. We do NOT warrant that we have obtained some intellectual properties, such as patent rights, with respect to such applications, or that the described applications may not infringe any intellectual property rights, such as patent rights, of a third party.

Panasonic
INDUSTRY

Panasonic Industry Co., Ltd.

Industrial Device Business Division

7-1-1, Morofuku, Daito-shi, Osaka 574-0044, Japan

industrial.panasonic.com/ac/e/