



WTF4FD-22162220A00

W4F

MINIATURE PHOTOELECTRIC SENSORS

SICK
Sensor Intelligence.



Illustration may differ

Ordering information

Type	Part no.
WTF4FD-22162220A00	1109266

Other models and accessories → www.sick.com/W4F



Detailed technical data

Features

Functional principle	Photoelectric proximity sensor
Functional principle detail	Foreground suppression
Sensing range	
Sensing range min.	0 mm
Sensing range max.	100 mm
Adjustable switching threshold for background suppression	15 mm ... 100 mm
Reference object	Object with 90% remission (complies with standard white according to DIN 5033)
Minimum distance between set sensing range and background (black 6% / white 90%)	0.8 mm (At 45 mm distance)
Recommended sensing range for the best performance	30 mm ... 70 mm
Emitted beam	
Light source	PinPoint LED
Type of light	Visible red light
Shape of light spot	Rectangular, Consisting of two parallel light spots
Light spot size (distance)	2 mm x 2 mm (50 mm)
Maximum dispersion of the emitted beam around the standardized transmission axis (squint angle)	< +/- 1.5° (at Ta = +23 °C)
Key LED figures	
Normative reference	EN 62471:2008-09 IEC 62471:2006, modified

LED risk group marking	Free group
Wave length	635 nm
Average service life	100,000 h at T _a = +25 °C
Smallest detectable object (MDO) typ.	0.1 mm (At 50 mm distance (object with 90% remission (complies with standard white according to DIN 5033)))
Adjustment	
Teach-Turn adjustment	BluePilot: For setting the sensing range
IO-Link	For configuring the sensor parameters and Smart Task functions
Indication	
LED blue	BluePilot: sensing range indicator
LED green	Operating indicator Static on: power on Flashing: IO-Link mode
LED yellow	Status of received light beam Static on: object present Static off: object not present
Special applications	Detecting flat objects

Safety-related parameters

MTTF_D	661 years
DC_{avg}	0 %
T_M (mission time)	20 years (EN ISO 13849) Rate of use: 60 %

Communication interface

IO-Link	✓, IO-Link V1.1
Data transmission rate	COM2 (38,4 kBaud)
Cycle time	2.3 ms
Process data length	16 Bit
Process data structure	Bit 0 = switching signal Q _{L1} Bit 1 = switching signal Q _{L2} Bit 2 ... 15 = Current receiver level (live)
VendorID	26
DeviceID HEX	0x80024F
DeviceID DEC	8389199
Compatible master port type	A
SIO mode support	Yes

Electrical data

Supply voltage U_B	10 V DC ... 30 V DC ¹⁾
Ripple	≤ 5 V _{pp}
Usage category	DC-12 (According to EN 60947-5-2) DC-13 (According to EN 60947-5-2)
Current consumption	≤ 25 mA, without load. At U _B = 24 V
Protection class	III

¹⁾ Limit values.

²⁾ Signal transit time with resistive load in switching mode.

³⁾ With light/dark ratio 1:1.

Digital output	
Number	2 (Complementary)
Type	Push-pull: PNP/NPN
Signal voltage PNP HIGH/LOW	Approx. $U_B - 2.5 \text{ V} / 0 \text{ V}$
Signal voltage NPN HIGH/LOW	Approx. $U_B / < 2.5 \text{ V}$
Output current I_{max}	$\leq 100 \text{ mA}$
Circuit protection outputs	Reverse polarity protected Overcurrent protected Short-circuit protected
Response time	$\leq 650 \mu\text{s}$
Repeatability (response time)	$300 \mu\text{s}^{2)}$
Switching frequency	$750 \text{ Hz}^{3)}$
Pin/Wire assignment	
Function of pin 4/black (BK)	Digital output, light switching, object present → output Q_{L1} LOW; IO-Link communication C
Function of pin 4/black (BK) – detail	The pin 4 function of the sensor can be configured, Additional possible settings via IO-Link
Function of pin 2/white (WH)	Digital output, dark switching, object present → output \bar{Q}_{L1} HIGH
Function of pin 2/white (WH) – detail	The pin 2 function of the sensor can be configured, Additional possible settings via IO-Link

¹⁾ Limit values.

²⁾ Signal transit time with resistive load in switching mode.

³⁾ With light/dark ratio 1:1.

Mechanical data

Housing	Rectangular
Dimensions (W x H x D)	16 mm x 40.1 mm x 12.1 mm
Connection	Male connector M8, 4-pin
Material	
Housing	Plastic, VISTAL®
Front screen	Plastic, PMMA
Male connector	Plastic, VISTAL®
LABS-free	Yes (VDMA 24364-A1-L)
Weight	Approx. 30 g
Maximum tightening torque of the fixing screws	0.4 Nm

Ambient data

Enclosure rating	IP66 (EN 60529) IP67 (EN 60529)
Ambient operating temperature	-40 °C ... +60 °C
Ambient temperature, storage	-40 °C ... +75 °C
Typ. Ambient light immunity	Artificial light: $\leq 50,000 \text{ lx}$ Sunlight: $\leq 50,000 \text{ lx}$
Shock resistance	30 g, 11 ms (3 positive and 3 negative shocks along X, Y, Z axes, 18 total shocks (EN60068-2-27))
Vibration resistance	10 Hz ... 1,000 Hz (Amplitude 1 mm, 3 x 30 min (EN60068-2-6))
Air humidity	35 % ... 95 %, relative humidity (no condensation)
Electromagnetic compatibility (EMC)	EN 60947-5-2

Resistance to cleaning agent	ECOLAB
UL File No.	NRKH.E181493 & NRKH7.E181493

Smart Task

Smart Task name	Base logics
Logic function	Direct AND OR
Timer function	Deactivated On delay Off delay ON and OFF delay Impulse (one shot)
Inverter	Yes
Switching frequency	SIO Logic: 700 Hz ¹⁾ IOL: 700 Hz ²⁾
Response time	SIO Logic: 700 µs ¹⁾ IOL: 700 µs ²⁾
Repeatability	SIO Logic: 350 µs ¹⁾ IOL: 400 µs ²⁾
Switching signal	
Switching signal Q _{L1}	Switching output
Switching signal \bar{Q}_{L1}	Switching output

¹⁾ Use of Smart Task functions without IO-Link communication (SIO mode).

²⁾ Use of Smart Task functions with IO-Link communication function.

Diagnosis

Device temperature	
Measuring range	Very cold, cold, moderate, warm, hot
Device status	Yes
Detailed device status	Yes
Operating hour counter	Yes
Operating hours counter with reset function	Yes
Quality of teach	Yes

Classifications

ECl@ss 5.0	27270904
ECl@ss 5.1.4	27270904
ECl@ss 6.0	27270904
ECl@ss 6.2	27270904
ECl@ss 7.0	27270904
ECl@ss 8.0	27270904
ECl@ss 8.1	27270904
ECl@ss 9.0	27270904
ECl@ss 10.0	27270904
ECl@ss 11.0	27270904
ECl@ss 12.0	27270903

ETIM 5.0	EC002719
ETIM 6.0	EC002719
ETIM 7.0	EC002719
ETIM 8.0	EC002719
UNSPSC 16.0901	39121528

Connection type

Male connector M8, 4-pin

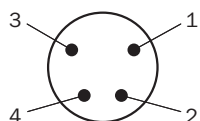

Connection diagram

Cd-490

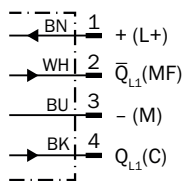

Truth table

Push-pull: PNP/NPN - light switching Q_{L1}

	Light switching Q_{L1} (normally closed (upper switch), normally open (lower switch))	
	Object not present → Output HIGH	Object present → Output LOW
Light receive	✓	✗
Light receive indicator	☀	✗
Load resistance to L+	✗	⚠
Load resistance to M	⚠	✗

Push-pull: PNP/NPN – dark switching \bar{Q}_L1

	Dark switching \bar{Q}_L1 (normally open (upper switch), normally closed (lower switch))	
	Object not present → Output LOW	Object present → Output HIGH
Light receive	✓	✗
Light receive indicator	☀	✗
Load resistance to L+	⚠	✗
Load resistance to M	✗	⚠

Characteristic curve

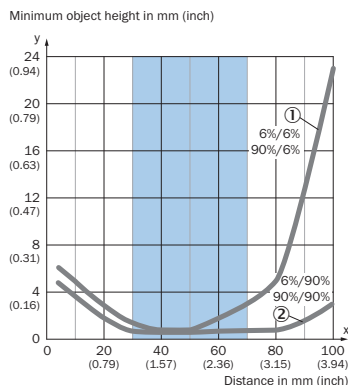

Example:
Reliable detection of the object

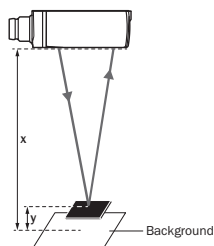

White background (90 % radiance factor)
Distance of sensor to background x = 40 mm
Required minimum object height y = 0.7 mm
For all objects regardless of their colors

Recommended sensing range for the best performance

- ① Black background, 6 % remission
- ② White background, 90% remission

Light spot size

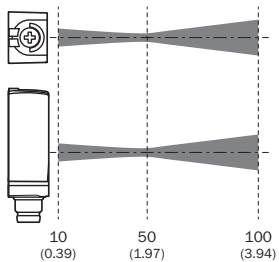
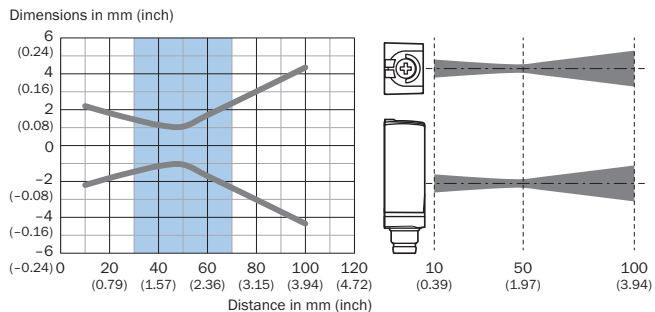

Recommended sensing range for the best performance

Sensing range diagram

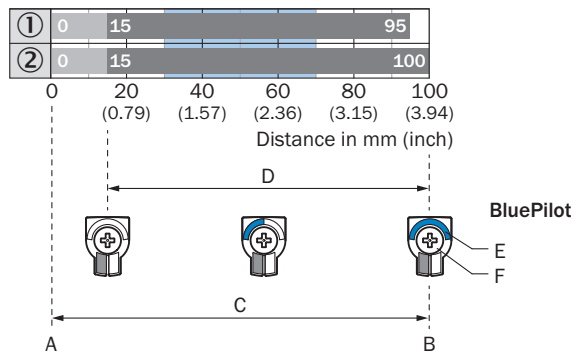

- A = Sensing range min. in mm
- B = Sensing range max. in mm
- C = Viewing range
- D = Adjustable switching threshold for foreground suppression
- E = Sensing range indicator
- F = Teach-Turn adjustment
- Recommended sensing range for the best performance
- ① Black background, 6 % remission
- ② White background, 90% remission

Adjustments

Display and adjustment elements

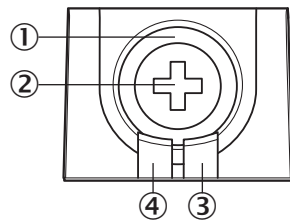

- ① LED blue
- ② Teach-Turn adjustment
- ③ LED yellow
- ④ LED green

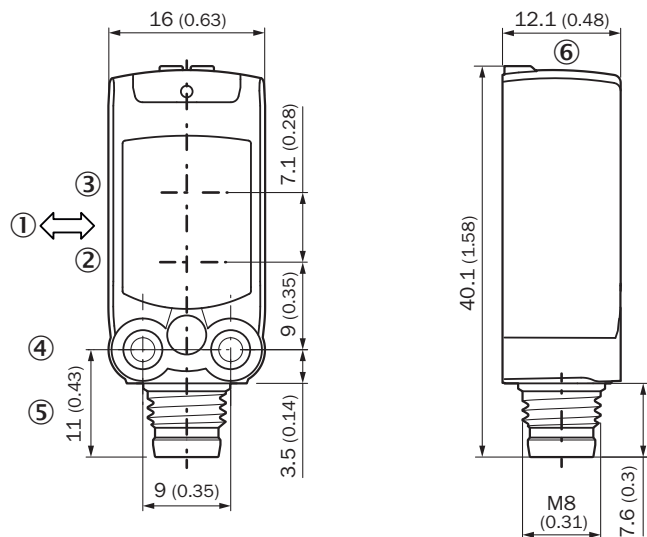

Dimensional drawing (Dimensions in mm (inch))



- ① Standard direction of the material being detected
- ② Center of optical axis, sender
- ③ Center of optical axis, receiver
- ④ M3 mounting hole
- ⑤ Connection
- ⑥ Display and adjustment elements

Recommended accessories

Other models and accessories → www.sick.com/W4F

	Brief description	Type	Part no.
Mounting brackets and plates			
	Mounting bracket for wall mounting, Stainless steel 1.4571, mounting hardware included	BEF-W4-A	2051628
Plug connectors and cables			
	Head A: male connector, M8, 4-pin, straight Cable: unshielded	STE-0804-G	6037323

SICK AT A GLANCE

SICK is one of the leading manufacturers of intelligent sensors and sensor solutions for industrial applications. A unique range of products and services creates the perfect basis for controlling processes securely and efficiently, protecting individuals from accidents and preventing damage to the environment.

We have extensive experience in a wide range of industries and understand their processes and requirements. With intelligent sensors, we can deliver exactly what our customers need. In application centers in Europe, Asia and North America, system solutions are tested and optimized in accordance with customer specifications. All this makes us a reliable supplier and development partner.

Comprehensive services complete our offering: SICK LifeTime Services provide support throughout the machine life cycle and ensure safety and productivity.

For us, that is “Sensor Intelligence.”

WORLDWIDE PRESENCE:

Contacts and other locations –www.sick.com