



PXIe-AWG5103 Bundle

Expandable PXI bundle based on PXIe-5433
AWG, 80MHz, 16 bits, 800 MS/s, 2 Channels

Specifications

PXIe-1083 and PXIe-5433

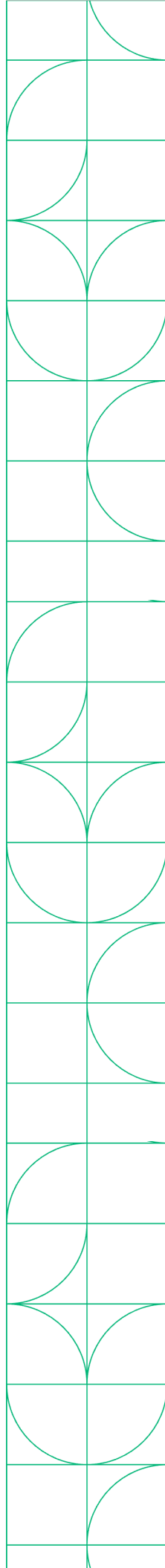

PXI AWG Bundle

In the Box

	PXIe-AWG5103 Bundle	Accessories:
PXIe-5433 Arbitrary Waveform Generator		<ul style="list-style-type: none">• SMA to SMA cable (x2)• Thunderbolt cable• Power cable (varied by PN)<ul style="list-style-type: none">○ 867122-01 (US)○ 867122-02 (EUR)○ 867122-03 (Generic)
	PXIe-1083 (5-Slot PXIe Chassis)	

Recommended Software

Test Workflow P/N: 788509-35	<p>Test Workflow is a bundle of select NI software featuring engineering-specific tools that help test professionals accomplish anything from their day-to-day work to overcoming their most challenging obstacles.</p>
	<p>Test Workflow includes:</p> <ul style="list-style-type: none">• LabVIEW - a graphical programming environment engineers use to develop automated research, validation, and production test systems.• InstrumentStudio - an application software that provides an integrated approach to interactive PXI measurements.• TestStand - a test executive software that accelerates system development and deployment for engineers in validation and production.• And more NI Software!

Table of Contents

This document combines the PDFs of this bundle together. The page numbers in the table of contents correspond to the page number of PDF the component's documentation begins.

PXIe-1083 Specifications.....	3
PXIe-5433 Specifications.....	16



PXle-1083 Specifications



PXIe-1083 Specifications

This document contains specifications for the PXIe-1083 chassis.

Electrical

The following section provides information about the PXIe-1083 AC input and DC output.

AC Input

Input rating	100 VAC to 240 VAC, 50 Hz/60 Hz, 6 A to 3 A
Operating voltage range ¹	90 VAC to 264 VAC
Nominal input frequency	50 Hz/60 Hz
Operating frequency range ¹	47 Hz to 63 Hz
Efficiency	78% typical
Over-current protection	Internal fuse in line
Main power disconnect	The AC power cable provides main power disconnect. Do not position the equipment so that it is difficult to disconnect the power cord. The front-panel power switch causes the internal chassis power supply to provide DC power to the PXI Express backplane.



Caution Disconnect power cord to completely remove power.

DC Output

DC output characteristics of the PXIe-1083.

Voltage Rail	Maximum Current	Load Regulation	Maximum Ripple and Noise (20 MHz BW)
+5V_AUX	1.0 A	±5%	50 mVpp
+12 V	30.1 A	±5%	120 mVpp
+5 V	25.1 A	±5%	50 mVpp
+3.3 V	30.7 A	±5%	50 mVpp
-12 V	0.75 A	±5%	120 mVpp

Maximum total available power for the PXIe-1083 is 293 W.

The maximum combined power available on +3.3 V and +5 V is 180 W.

The maximum power available for each Thunderbolt port is 15 W (5 V/3 A).

Table 1. Backplane Slot Current Capacity

Slot	+5 V	V (I/O)	+3.3 V	+12 V	-12 V	5 V _{AUX}
Hybrid Peripheral Slot with PXI-5 Peripheral	-	-	3 A	6 A	-	1 A
Hybrid Peripheral Slot with PXI-1 Peripheral	6 A	5 A	6 A	1 A	1 A	-



Note PCI V(I/O) pins in Hybrid Peripheral Slots are connected to +5 V.



Note The maximum power dissipated in a peripheral slot should not exceed 58 W. Refer to the **Operating Environment** section for ambient temperature considerations at 58 W.

Over-current protection	All outputs are protected from short circuit and overload, they recover and return to regulation when the overload is removed and the power is cycled.
Over-voltage protection	+3.3 V clamped at 3.7 V to 4.3 V, +5 V clamped at 5.7 V to 6.5 V, +12 V clamped at 13.4 V to 15.6 V

Chassis Cooling

Module cooling	Forced air circulation (positive pressurization) through one 150 CFM fan
Module slot airflow direction	Bottom of module to top of module
Module intake	Bottom of chassis
Module exhaust	Top, right side of chassis
Slot cooling capacity	58 W; slot 6 supports 58 W cooling with high fan mode
Power supply cooling	Forced air circulation through integrated fans
Power supply intake	Front and left side chassis
Power supply exhaust	Rear of chassis
Minimum chassis cooling clearances	
Above	44.45 mm (1.75 in.)
Rear	44.45 mm (1.75 in.)
Sides	44.45 mm (1.75 in.)
Below	
Rack	44.45 mm (1.75 in.)
Desktop	25.4 mm (1.00 in.)

Environmental

Maximum altitude	2,000 m (6,560 ft.), 800 mbar (at 25 °C ambient, high fan mode)
Pollution Degree	2

Indoor use only.

Operating Environment

Ambient temperature range	
When all peripheral modules require ≤ 38 W cooling capacity per slot	0 °C to 50 °C (IEC 60068-2-1 and IEC 60068-2-2.) ² Meets MIL-PRF-28800F Class 3 low temperature limit and high temperature limit.
When any peripheral module requires > 38 W cooling capacity per slot	0 °C to 40 °C (IEC 60068-2-1 and IEC 60068-2-2.) ² Meets MIL-PRF-28800F Class 3 low temperature limit and MIL-PRF-28800F Class 4 high temperature limit.
Relative humidity range	20% to 80%, noncondensing

Storage Environment

Ambient temperature range	-40 °C to 71 °C (IEC-60068-2-1 and IEC-60068-2-2.) ^[3] Meets MIL-PRF-28800F Class 3 limits.
Relative humidity range	10% to 95%, noncondensing

Shock and Vibration

Operational shock	30 g peak, half-sine, 11 ms pulse (IEC-60068-2-27.) ³ Meets MIL-PRF-28800F Class 2 limits.
Operational random vibration	5 to 500 Hz, 0.3 g _{rms}
Non-operating vibration	5 to 500 Hz, 2.4 g _{rms} (IEC 60068-2-64.) ³ Non-operating test profile exceeds the requirements of MIL-PRF-28800F, Class 3.

Acoustic Emissions

Sound Pressure Level (at Operator Position)

(Tested in accordance with ISO 7779. Meets MIL-PRF-28800F requirements.)

38 W Profile

Auto fan (up to 30 °C ambient)	33.7 dBA
High fan	50.8 dBA

58 W Profile

Auto fan (up to 30 °C ambient)	54.7 dBA
High fan	55.3 dBA

Sound Power Level

38 W Profile

Auto fan (up to 30 °C ambient)	44.9 dBA
High fan	60.3 dBA

58 W Profile

Auto fan (up to 30 °C ambient)	63.4 dBA
High fan	64.2 dBA



Note The protection provided by the PXIe-1083 can be impaired if it is used in a manner not described in this document.

Safety Compliance Standards

This product is designed to meet the requirements of the following electrical equipment safety standards for measurement, control, and laboratory use:

- IEC 61010-1, EN 61010-1
- UL 61010-1, CSA C22.2 No. 61010-1



Note For safety certifications, refer to the product label or the [Product Certifications and Declarations](#) section.

EMC Guidelines

This product was tested and complies with the regulatory requirements and limits for electromagnetic compatibility (EMC) stated in the product specifications. These requirements and limits provide reasonable protection against harmful interference when the product is operated in the intended operational electromagnetic environment.

This product is intended for use in industrial locations. However, harmful interference may occur in some installations, when the product is connected to a peripheral device or test object, or if the product is used in residential areas. To minimize interference with radio and television reception and prevent unacceptable performance degradation, install and use this product in strict accordance with the instructions in the product documentation.

Furthermore, any changes or modifications to the product not expressly approved by NI could void your authority to operate it under your local regulatory rules.

EMC Notices

Refer to the following notices for cables, accessories, and prevention measures necessary to ensure the specified EMC performance.



Notice

For EMC declarations and certifications, and additional information, refer to the [Product Certifications and Declarations](#) section.



Notice Changes or modifications to the product not expressly approved by NI could void your authority to operate the product under your local regulatory rules.



Notice Operate this product only with shielded cables and accessories.

Electromagnetic Compatibility Standards

This product meets the requirements of the following EMC standards for electrical equipment for measurement, control, and laboratory use:

- EN 61326-1 (IEC 61326-1): Class A emissions; Basic immunity
- EN 55011 (CISPR 11): Group 1, Class A emissions

- AS/NZS CISPR 11: Group 1, Class A emissions



Note Group 1 equipment (per CISPR 11) is any industrial, scientific, or medical equipment that does not intentionally generate radio frequency energy for the treatment of material or inspection/analysis purposes.



Note In Europe, Canada, Australia, and New Zealand (per CISPR 11) Class A equipment is intended for use in nonresidential locations.

CE Compliance

This product meets the essential requirements of applicable European Directives, as follows:

- 2014/35/EU; Low-Voltage Directive (safety)
- 2014/30/EU; Electromagnetic Compatibility Directive (EMC)
- 2011/65/EU; Restriction of Hazardous Substances (RoHS)

Product Certifications and Declarations

Refer to the product Declaration of Conformity (DoC) for additional regulatory compliance information. To obtain product certifications and the DoC for NI products, visit ni.com/product-certifications, search by model number, and click the appropriate link.

Environmental Management

NI is committed to designing and manufacturing products in an environmentally responsible manner. NI recognizes that eliminating certain hazardous substances from our products is beneficial to the environment and to NI customers.

For additional environmental information, refer to the **Engineering a Healthy Planet** web page at ni.com/environment. This page contains the environmental

regulations and directives with which NI complies, as well as other environmental information not included in this document.

EU and UK Customers

-  Waste Electrical and Electronic Equipment (WEEE)—At the end of the product life cycle, all NI products must be disposed of according to local laws and regulations. For more information about how to recycle NI products in your region, visit ni.com/environment/weee.

电子信息产品污染控制管理办法 (中国 RoHS)

-  中国 RoHS— NI 符合中国电子信息产品中限制使用某些有害物质指令(RoHS)。关于 NI 中国 RoHS 合规性信息，请登录 ni.com/environment/rohs_china。(For information about China RoHS compliance, go to ni.com/environment/rohs_china.)

Backplane

Size	3U-sized; 5 peripheral slots. Compliant with IEEE 1101.10 mechanical packaging. PXI Express Specification compliant. Accepts both PXI Express and CompactPCI (PICMG 2.0 R 3.0) 3U modules.
Backplane bare-board material	UL 94 V-0 Recognized
Backplane connectors	Conforms to IEC 917 and IEC 1076-4-101, UL 94 V-0 rated

System Synchronization Clocks

10 MHz System Reference Clock: PXI_CLK10

Maximum slot-to-slot skew	250 ps
Accuracy	± 25 ppm max (guaranteed over the operating temperature range)
Maximum jitter	5 ps RMS phase-jitter (10 Hz–1 MHz range)
Duty-factor	45% to 55%
Unloaded signal swing	3.3 V \pm 0.3 V



Note For other specifications, refer to the **PXI-1 Hardware Specification**.

100 MHz System Reference Clock: PXIe_CLK100 and PXIe_SYNC100

Maximum slot-to-slot skew	100 ps
Accuracy	± 25 ppm max (guaranteed over the operating temperature range)
Maximum jitter	3 ps RMS phase-jitter (10 Hz to 12 kHz range), 2 ps RMS phase-jitter (12 kHz to 20 MHz range)
Duty-factor for PXIe_CLK100	45% to 55%
Absolute differential voltage (When terminated with a 50 Ω load to 1.30 V or Thévenin equivalent)	400 mV to 1000 mV



Note For other specifications, refer to the **PXI-5 PXI Express Hardware Specification**.

Mechanical

Standard chassis dimensions	
Height	177.1 mm (6.97 in.)
Width	257.1 mm (10.12 in.)
Depth	214.2 mm (8.43 in.)
Weight	6.7 kg (14.8 lb)
Chassis materials	Extruded Aluminum (6063-T5, 6060-T6), Cold Rolled Steel/Stainless Steel, Santoprene, Urethane Foam, PC-ABS, Nylon, Polyethylene
Finish	Conductive Clear Iridite on Aluminum, Electroplated Nickel on Cold Rolled Steel, Electroplated Zinc on Cold Rolled Steel

The following figures show the PXIe-1083 chassis dimensions. The holes shown are for installing the optional rack mount kits.

Figure 1. PXIe-1083 Chassis Dimensions (Front)

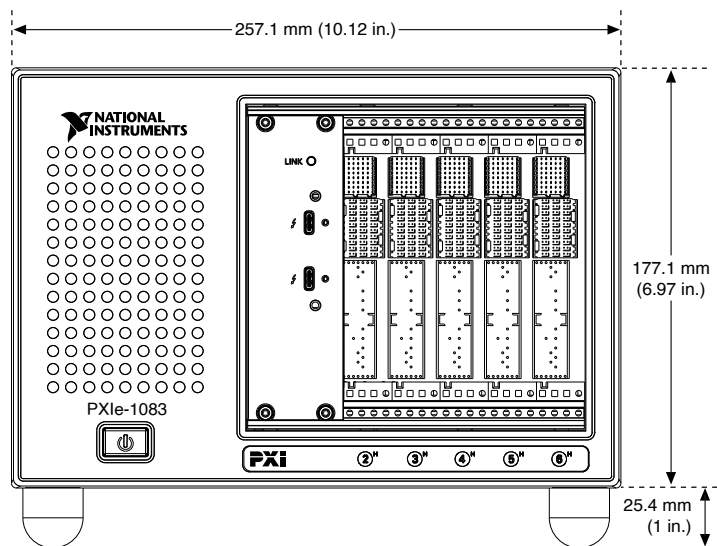

Figure 2. PXIe-1083 Chassis Dimensions (Side)

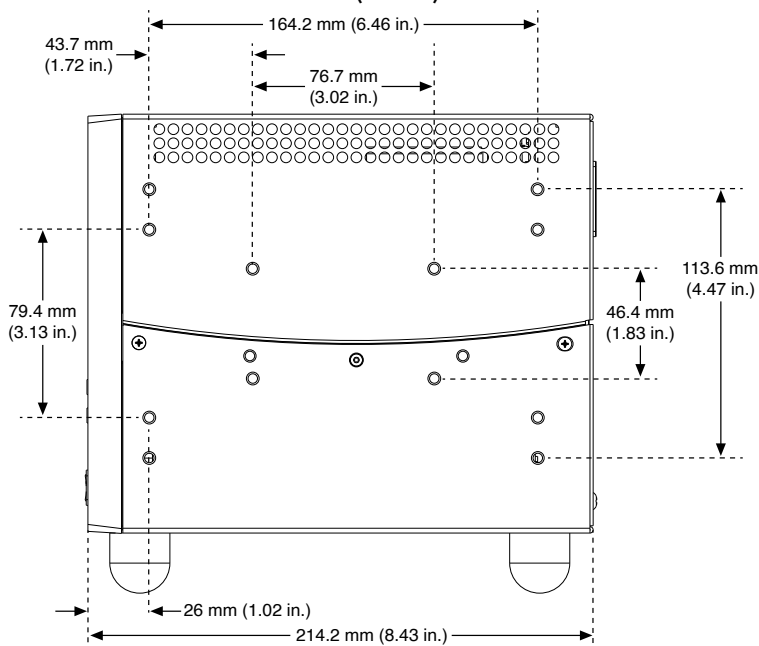
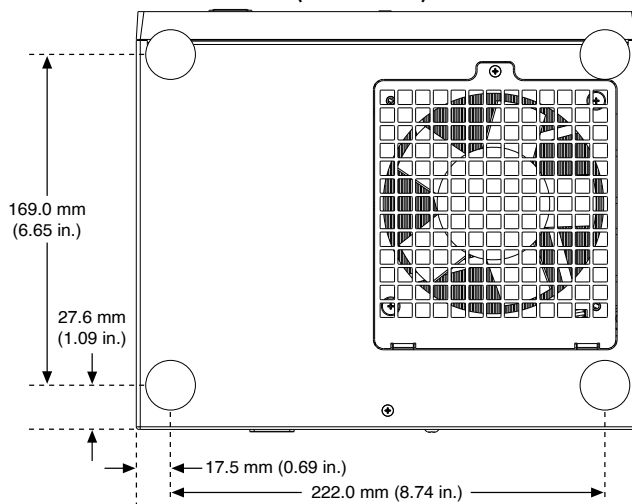

Figure 3. PXIe-1083 Chassis Dimensions (Bottom)



¹ The operating range is guaranteed by design.

² This product meets the requirements of the environmental standards for electrical equipment for measurement, control, and laboratory use.

³ This product meets the requirements of the environmental standards for electrical equipment for measurement, control, and laboratory use.

PXIe-5433

Specifications

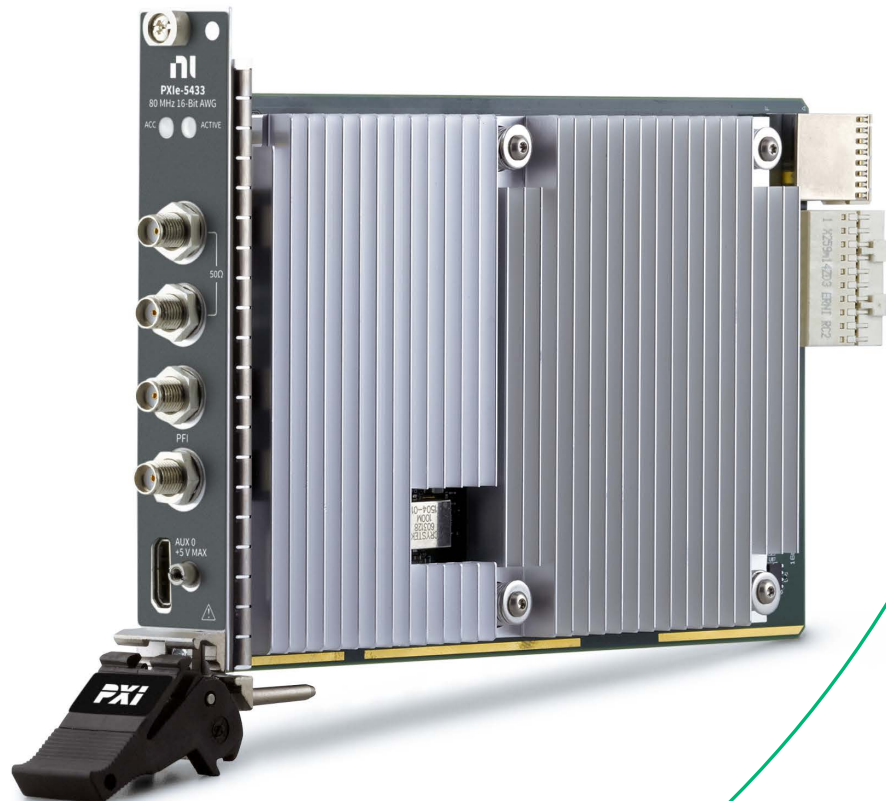

PXIe-5433 Specifications

These specifications apply to the one-channel and two-channel PXIe-5433.

Definitions

Warranted specifications describe the performance of a model under stated operating conditions and are covered by the model warranty. Warranted specifications account for measurement uncertainties, temperature drift, and aging. Warranted specifications are ensured by design or verified during production and calibration.

The following characteristic specifications describe values that are relevant to the use of the model under stated operating conditions but are not covered by the model warranty.

- **Typical** specifications describe the performance met by a majority of models.
- **Nominal** specifications describe an attribute that is based on design, conformance testing, or supplemental testing.
- **Measured** specifications describe the measured performance of a representative model.

Conditions

All specifications are valid under the following conditions unless otherwise noted:

- Signals terminated with 50 Ω to ground
- Load impedance set to 50 Ω
- Amplitude set to 2.4 V_{pk-pk}
- Analog Path property or NIFGEN_ATTR_ANALOG_PATH attribute set to **Main** (default)
- Reference Clock set to **Onboard Reference Clock**

Warranted and typical specifications are valid under the following conditions unless otherwise noted:

- Ambient temperature range of 0 °C to 55 °C
- 15-minute warm-up time before operation
- Self-calibration performed after instrument is stable
- External calibration cycle maintained and valid
- PXI Express chassis fan speed set to HIGH, foam fan filters removed if present, and empty slots contain PXI chassis slot blockers and filler panels

Analog Output

Number of channels ^[1]	2
Output type	Referenced single-ended
Connector type	SMA
DAC resolution	16 bits
Amplitude range^[2], in 0.16 dB steps	
50 Ω load	0.00775 V _{pk-pk} to 12 V _{pk-pk}
Open load	0.0155 V _{pk-pk} to 24 V _{pk-pk}
Offset range	±50% of Amplitude Range (V _{pk-pk}) ^[3]
Offset resolution	16-bit full-scale range
DC accuracy^[4]	

Within ± 5 °C of self-calibration temperature	$\pm 0.35\%$ of Amplitude Range $\pm 0.35\%$ of Offset Requested ± 500 μV , warranted ^[5]
0 °C to 55 °C	$\pm 0.55\%$ of Amplitude Range $\pm 0.55\%$ of Offset Requested ± 500 μV , typical
AC amplitude accuracy ^[6] (within ± 5 °C of self-calibration temperature)	$\pm 1.0\% \pm 1$ mV _{pk-pk} , warranted
Output impedance	50 Ω
Load impedance	Output waveform is compensated for user-specified impedances
Output coupling (ground referenced)	DC
Output enable ^[7]	Software-selectable
Maximum output overload ^[8]	± 12 V _{pk-pk} from a 50 Ω source
Waveform summing	Supported ^[9]

Standard Function

Sine Waveform

Frequency range	0 MHz to 80 MHz	
Frequency step size	2.84 μHz	
Sine Frequency	Passband Flatness (dB), Warranted	
	0.06 V _{pk-pk} to 2.75 V _{pk-pk}	>2.75 V _{pk-pk}
1 MHz	± 0.4	± 0.4

Sine Frequency	Passband Flatness (dB), Warranted	
	0.06 V_{pk-pk} to 2.75 V_{pk-pk}	>2.75 V_{pk-pk}
10 MHz	±0.4	±0.4
20 MHz	±0.4	±0.6
40 MHz ^[11]	±0.45	±0.8
60 MHz ^[11]	±0.5	—
80 MHz ^[11]	±0.65	—

Table 1. Passband Flatness^[10]

Figure 1. Passband Flatness

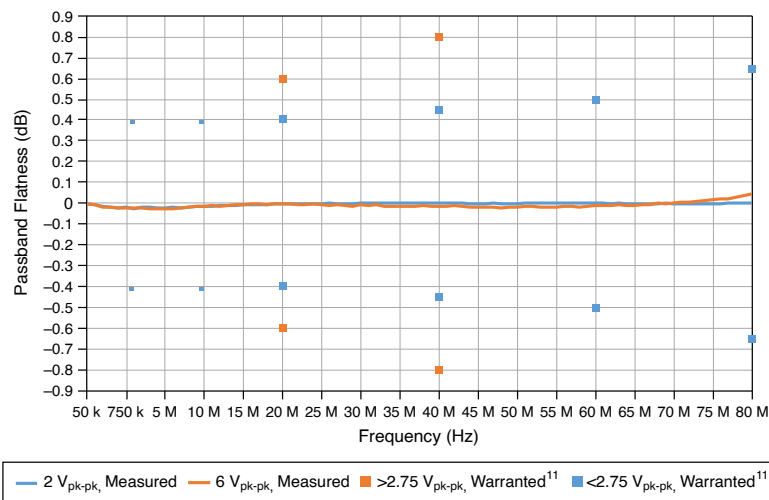

Sine Frequency	SFDR with Harmonics (dBC), Measured		
	0.1 V_{pk-pk} to 1 V_{pk-pk}	1 V_{pk-pk} to 2.75 V_{pk-pk}	>2.75 V_{pk-pk} ^[13]
1 MHz	62	76	77
3 MHz	62	74	63
5 MHz	61	74	58
10 MHz	61	69	52
20 MHz	61	63	44
30 MHz	59	60	40
40 MHz	55	58	35
80 MHz	41	45	—

Table 2. Spurious-Free Dynamic Range (SFDR) with Harmonics^[12]

Sine Frequency	SFDR without Harmonics (dBc), Measured		
	0.1 V _{pk-pk} to 1 V _{pk-pk}	1 V _{pk-pk} to 2.75 V _{pk-pk}	>2.75 V _{pk-pk} ^[13]
1 MHz	62	84	92
3 MHz	62	84	92
5 MHz	62	84	92
10 MHz	61	83	90
20 MHz	61	83	90
30 MHz	61	83	83
40 MHz	61	83	83
80 MHz	61	83	—

Table 3. Spurious-Free Dynamic Range (SFDR) without Harmonics^[12]

Sine Frequency	THD (dBc), Measured	
	0.1 V _{pk-pk} to 2.75 V _{pk-pk}	2.75 V _{pk-pk} to 12 V _{pk-pk} ^[13]
1 MHz	79	76
3 MHz	73	62
5 MHz	72	56
10 MHz	68	49
20 MHz	61	43
30 MHz	58	39
40 MHz	55	35
80 MHz	40	—

Table 4. Total Harmonic Distortion (THD)^[14]

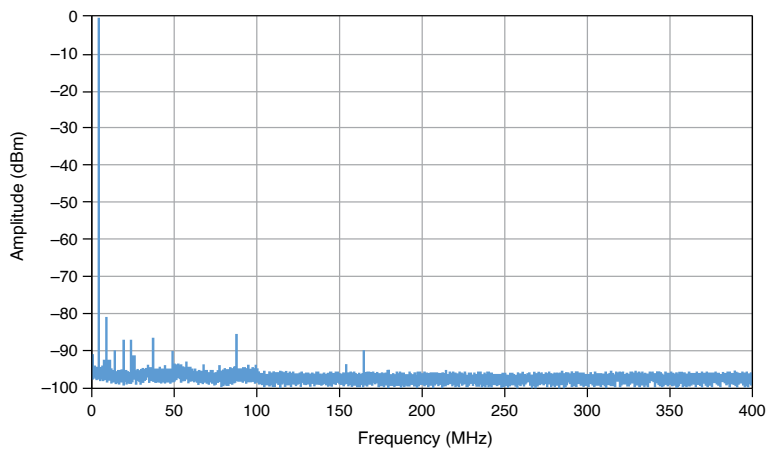
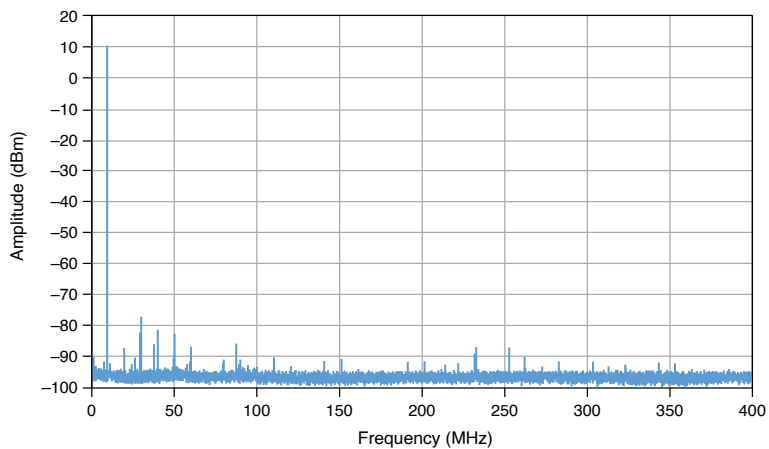
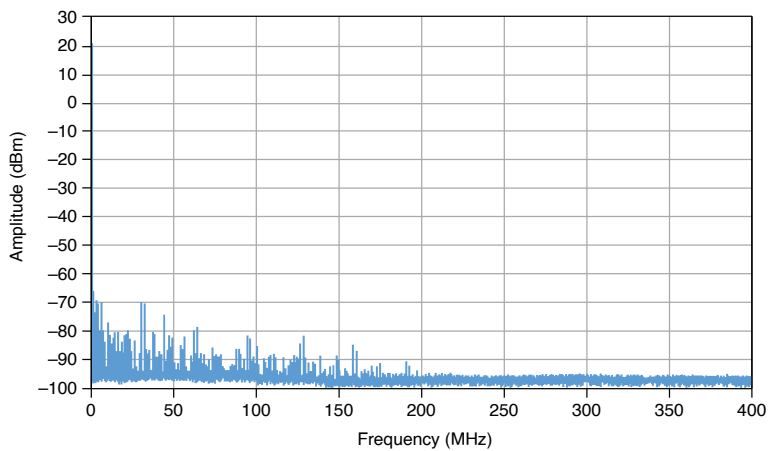
Figure 2. 5 MHz Spectrum^[15] at 0.6 V_{pk-pk}, MeasuredFigure 3. 10 MHz Spectrum^[15] at 2 V_{pk-pk}, MeasuredFigure 4. 1 MHz Spectrum^[15] at 6.5 V_{pk-pk}, Measured

Amplitude	Average Noise Density, Typical	
	dBm/Hz	$\frac{\text{nV}}{\sqrt{\text{Hz}}}$
0.06 V _{pk-pk}	-154	3.9
0.1 V _{pk-pk}	-154	3.9
0.4 V _{pk-pk}	-150	5.8
1 V _{pk-pk}	-145	13
2 V _{pk-pk}	-141	20
4 V _{pk-pk}	-132	53
12 V _{pk-pk}	-125	107

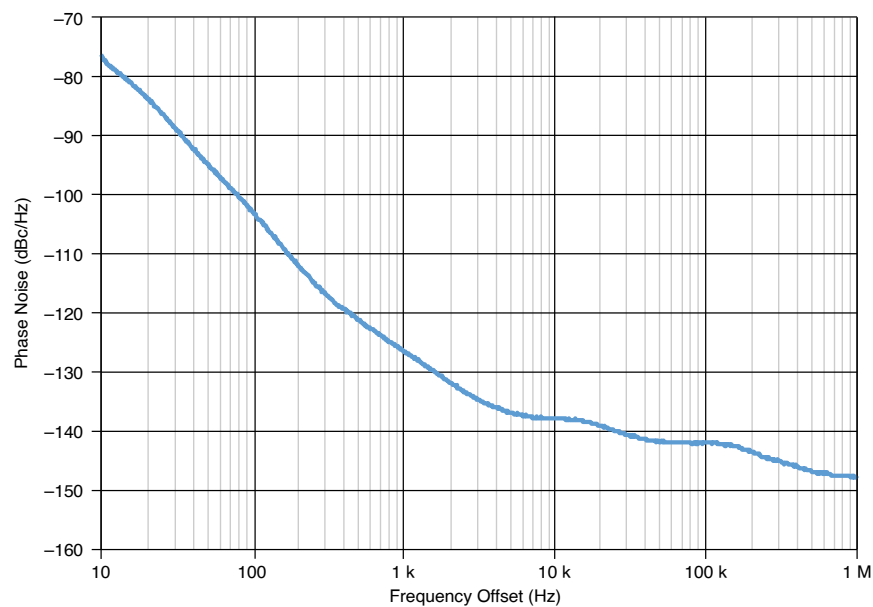
Table 5. Average Noise Density^[16]Figure 1. Phase Noise^[17], MeasuredJitter (RMS)^[18]

207 fs

Square Waveform

Frequency range

2.75 V _{pk-pk}	0 MHz to 50 MHz
12 V _{pk-pk}	0 MHz to 30 MHz
Frequency step size	2.84 μHz
Minimum on/off time ^[19]	8.25 ns
Duty cycle resolution	<0.001%
Rise/fall time^[20]	
<2.75 V _{pk-pk}	4.5 ns, measured
>2.75 V _{pk-pk} ^[21]	5.4 ns, measured
Aberration	
<2.75 V _{pk-pk}	1.0%, measured
>2.75 V _{pk-pk}	5.0%, measured
Jitter (RMS) ^[22]	1.5 ps, measured

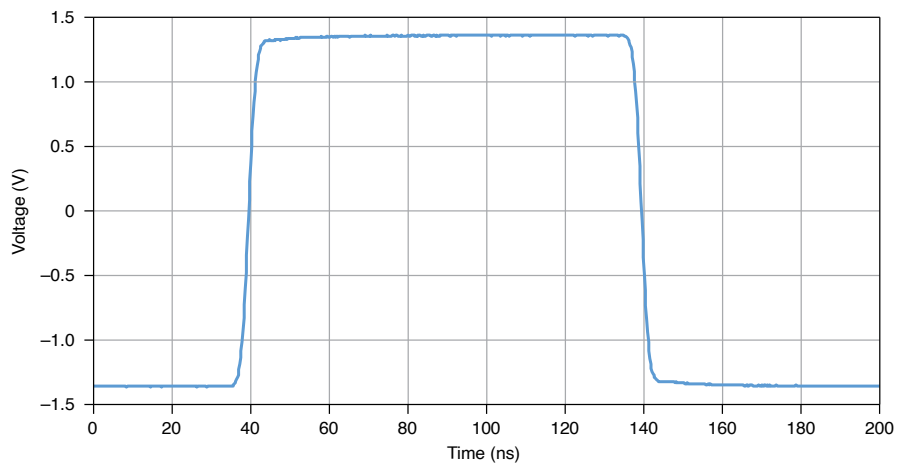
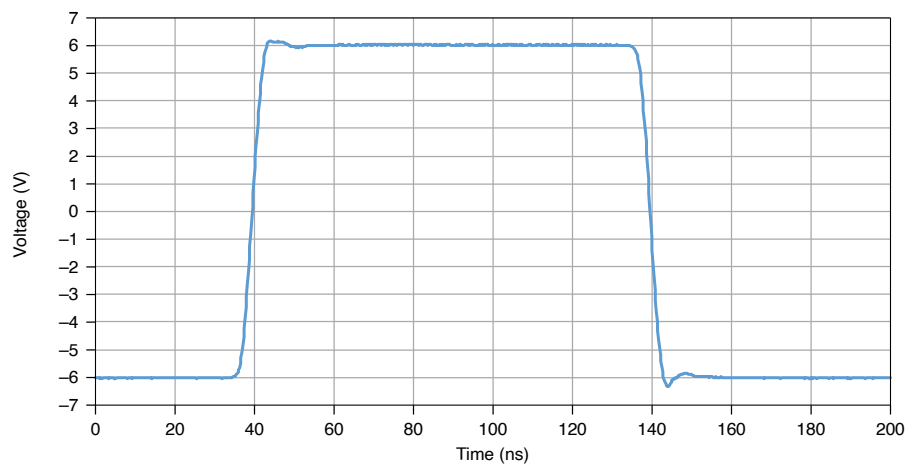
Figure 1. Square Waveform Step Response at 2.75 V_{pk-pk}, MeasuredFigure 7. Square Waveform Step Response at 12 V_{pk-pk}, Measured

Ramp and Triangle Waveforms

Frequency range

2.75 V_{pk-pk}

0 MHz to 50 MHz

12 V_{pk-pk}

0 MHz to 30 MHz

Noise Function

Gaussian noise

Bandwidth	100 MHz, measured
Crest factor	5, measured
Repetition period	5,849 years

User-Defined Function

Frequency range	0 MHz to 80 MHz
Frequency step size	2.84 μ Hz
Waveform points	8,192
Step response rise time	
2.75 V_{pk-pk}	2.4 ns, measured
12 V_{pk-pk}	2.7 ns, measured

Arbitrary Waveform

Waveform size	4 samples to 256,000,000 samples
User sample rate	
Digital filter enabled	5.6 μ S/s to 400 MS/s

Digital filter disabled	10 S/s to 250 MS/s
Waveform filters	
Digital filter enabled	Bandwidth = 0.2 * User Sample Rate
Digital filter disabled	No reconstruction image rejection
Minimum quantum size	1 sample
Rise time^[23]	
Digital filter enabled	4.7 ns, measured
Digital filter disabled	3.4 ns, measured
Total onboard memory	512 MB per channel

Figure 8. Magnitude Response^[24], Measured

Figure 9. 10 MHz Single-Tone Spectrum^[25], MeasuredFigure 10. 9.5 MHz and 10.5 MHz Dual-Tone Spectrum^[26], Measured

All Output Modes

Figure 11. Amplitude Versus Recommended Sine Wave Frequency

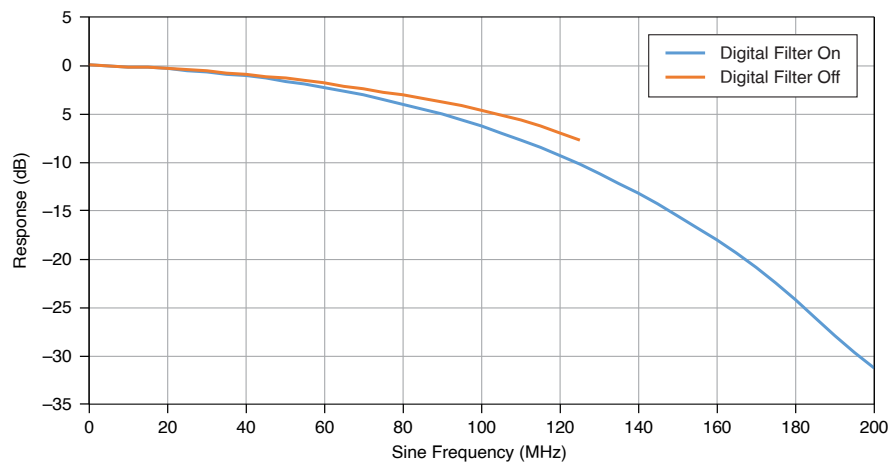
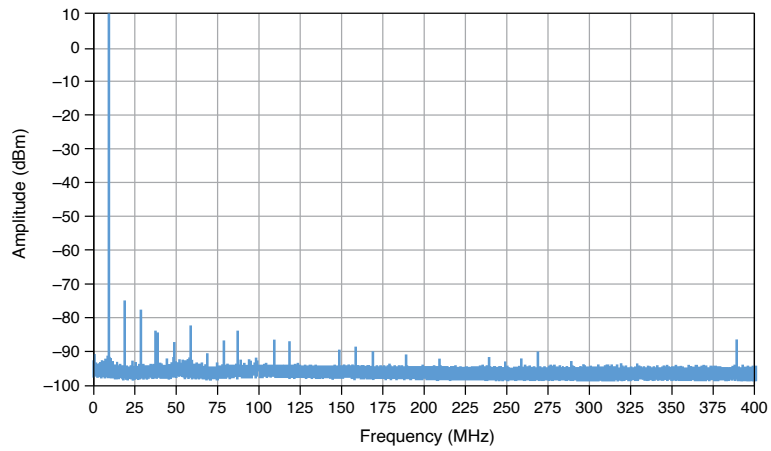
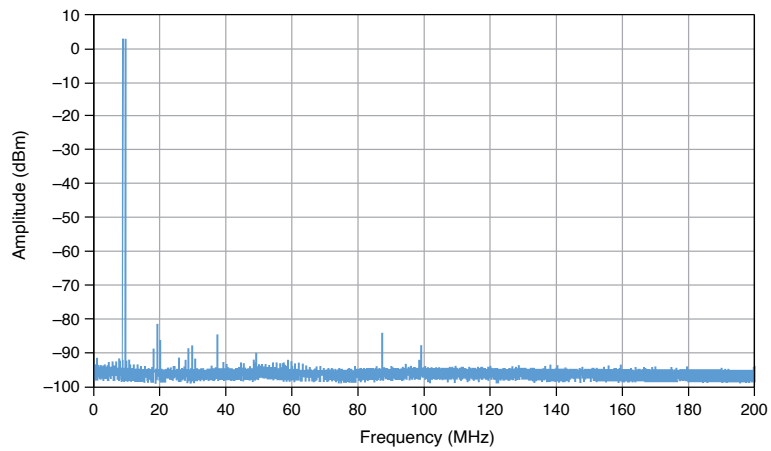
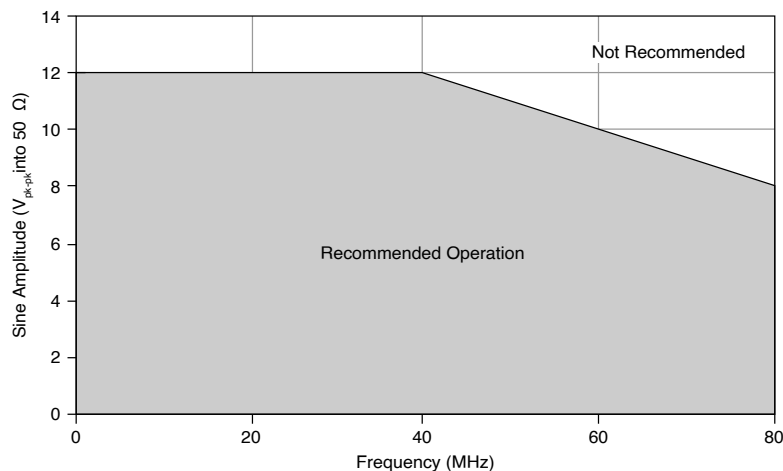

Figure 1. Channel-To-Channel Crosstalk, Measured

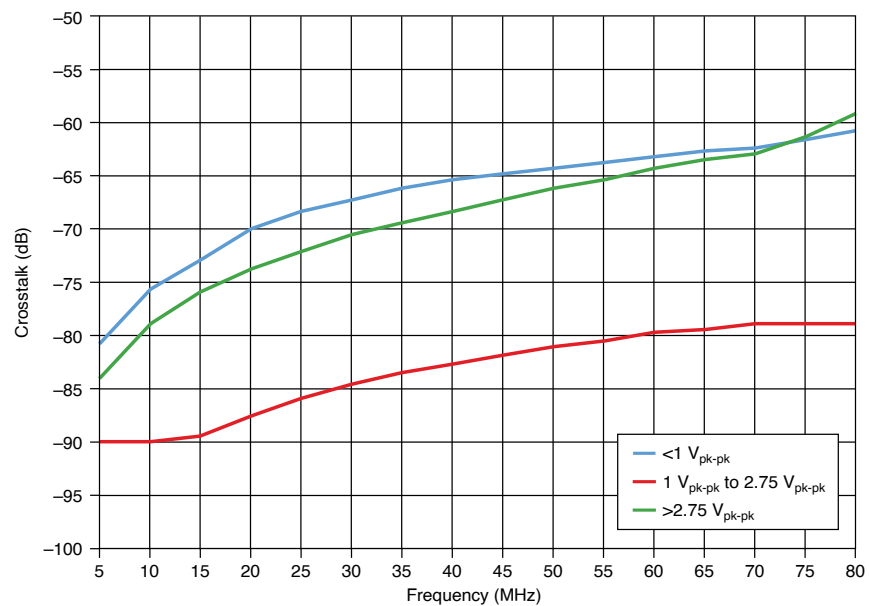
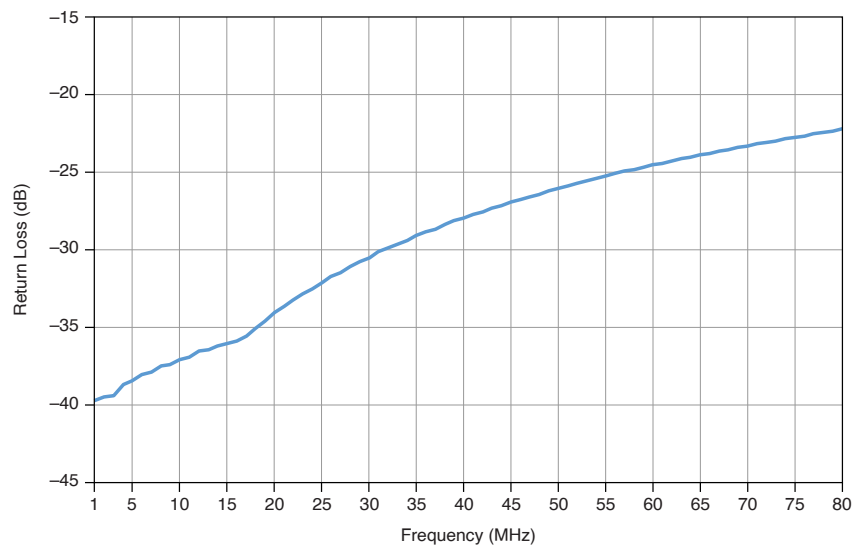

Figure 1. Return Loss, Measured



Clock

Reference Clock source	Internal PXIe_CLK100 (backplane connector)
Reference Clock frequency	100 MHz ($\pm 25\text{ ppm}$)
Sample Clock rate	800 MHz
Internal timebase accuracy ^[27]	
Initial calibrated accuracy	1.5 ppm, warranted
Time drift ^[28]	1 ppm per year, warranted
Accuracy	Initial Calibrated Accuracy \pm Time Drift , warranted

Synchronization

Channel-to-channel skew, between the channels of a multichannel PXIe-5433^[29]

<2.75 Vpk-pk	±110 ps
>2.75 Vpk-pk	±275 ps

Note The channels of a multichannel PXIe-5433 are automatically synchronized when they are in the same NI-FGEN session.

Synchronization with the NI-TClk API^[30]

NI-TClk is an API that enables system synchronization of supported PXI modules in one or more PXI chassis, which you can use with the PXIe-5433 and NI-FGEN.

NI-TClk uses a shared Reference Clock and triggers to align the Sample Clocks of PXI modules and synchronize the distribution and reception of triggers. These signals are routed through the PXI chassis backplane without external cable connections between PXI modules in the same chassis.

Module-to-module skew, between PXIe-5433 modules using NI-TClk^[31]

NI-TClk synchronization without manual adjustment^[32]

Skew, peak-to-peak ^[33]	300 ps, typical
Jitter, peak-to-peak ^[34]	125 ps, typical

NI-TClk synchronization with manual adjustment^[32]

Skew, average	<10 ps
---------------	--------

Jitter, peak-to-peak ^[34]	5 ps
Sample Clock delay/adjustment resolution	$3.8E(-6) * \text{Sample Clock period}$ For example, at 100 MS/s, $3.8E(-6) * (1/100 \text{ MS/s}) = 38 \text{ fs}$.

PFI I/O

Number of terminals	10
Connector type	
PFI 0 and PFI 1	SMA
AUX 0/PFI <0..7>	MHDMR
Logic level	3.3 V
Maximum input voltage	+5 V
V_{IH}	2 V
V_{IL}	0.8 V
Frequency range	0 MHz to 25 MHz
PFI-to-channel crosstalk	-80 dBc, measured

Trigger

Sources/destinations	PFI <0..1> (SMA front panel connectors)
----------------------	---

	AUX 0/PFI <0..7> (MHDMR front panel connector) PXI_Trig <0..7> (backplane connector)
Supported triggers	Start Trigger Script Trigger
Trigger type	Rising edge
Trigger modes ^[35]	Single Continuous Stepped Burst
Input impedance (DC)	>100 k Ω

Marker

Destinations	PFI <0..1> (SMA front panel connectors) AUX 0/PFI <0..7> (MHDMR front panel connector) PXI_Trig <0..7> (backplane connector)
Pulse width	200 ns
Marker to output skew	
PFI <0..1> and AUX 0/PFI <0..7>	± 2 ns

PXI_Trig <0..7>	±20 ns
Maximum number of marker outputs per waveform	4

Calibration

Self-calibration	An onboard reference is used to calibrate the DC gain and offset. The self-calibration is initiated by the user through the software and takes approximately 2 minutes to complete.
External calibration	External calibration calibrates the TCXO, voltage reference, and DC gain and offset. Appropriate constants are stored in nonvolatile memory.
Calibration interval	Specifications valid within 2 years of external calibration
Warm-up time ^[36]	15 minutes

Power

Current	
+3.3 V rail	2.3 A
+12 V rail	1.8 A
Total power	29 W

Environment

Maximum altitude	2,000 m (800 mbar) (at 25 °C ambient temperature)
------------------	---

Pollution Degree	2
------------------	---

Indoor use only.

Operating Environment

Ambient temperature range	0 °C to 55 °C (Tested in accordance with IEC 60068-2-1 and IEC 60068-2-2. Meets MIL-PRF-28800F Class 3 low temperature limit and MIL-PRF-28800F Class 2 high temperature limit.)
Relative humidity range	10% to 90%, noncondensing (Tested in accordance with IEC 60068-2-56.)

Storage Environment

Ambient temperature range	-40 °C to 71 °C (Tested in accordance with IEC 60068-2-1 and IEC 60068-2-2. Meets MIL-PRF-28800F Class 3 limits.)
Relative humidity range	5% to 95%, noncondensing (Tested in accordance with IEC 60068-2-56.)

Shock and Vibration

Operating shock	30 g peak, half-sine, 11 ms pulse (Tested in accordance with IEC 60068-2-27. Meets MIL-PRF-28800F Class 2 limits.)
Random vibration	
Operating	5 Hz to 500 Hz, 0.3 g _{rms} (Tested in accordance with IEC 60068-2-64.)
Nonoperating	5 Hz to 500 Hz, 2.4 g _{rms} (Tested in accordance with IEC 60068-2-64. Test profile exceeds the requirements of MIL-PRF-28800F, Class 3.)

Physical

Dimensions	21.6 cm × 2.0 cm × 13.0 cm (8.5 in. × 0.8 in. × 5.1 in.) 3 U, one slot, PXI Express module	
Weight		
One channel		369 g (13.0 oz)
Two channels		376 g (13.3 oz)
Bus interface		
Form factor		Gen 1 x4 module
Slot compatibility		PXI Express or hybrid

Compliance and Certifications

Safety Compliance Standards

This product is designed to meet the requirements of the following electrical equipment safety standards for measurement, control, and laboratory use:

- IEC 61010-1, EN 61010-1
- UL 61010-1, CSA C22.2 No. 61010-1

Note For UL and other safety certifications, refer to the product label or the [Product Certifications and Declarations](#) section.

Electromagnetic Compatibility

This product meets the requirements of the following EMC standards for electrical equipment for measurement, control, and laboratory use:

- EN 61326-1 (IEC 61326-1): Class A emissions; Basic immunity

- EN 55011 (CISPR 11): Group 1, Class A emissions
- EN 55022 (CISPR 22): Class A emissions
- EN 55024 (CISPR 24): Immunity
- AS/NZS CISPR 11: Group 1, Class A emissions
- AS/NZS CISPR 22: Class A emissions
- FCC 47 CFR Part 15B: Class A emissions
- ICES-001: Class A emissions

Note In the United States (per FCC 47 CFR), Class A equipment is intended for use in commercial, light-industrial, and heavy-industrial locations. In Europe, Canada, Australia, and New Zealand (per CISPR 11), Class A equipment is intended for use only in heavy-industrial locations.

Note Group 1 equipment (per CISPR 11) is any industrial, scientific, or medical equipment that does not intentionally generate radio frequency energy for the treatment of material or inspection/analysis purposes.

Note For EMC declarations, certifications, and additional information, refer to the [Online Product Certification](#) section.

CE Compliance

This product meets the essential requirements of applicable European Directives, as follows:

- 2014/35/EU; Low-Voltage Directive (safety)
- 2014/30/EU; Electromagnetic Compatibility Directive (EMC)

Product Certifications and Declarations

Refer to the product Declaration of Conformity (DoC) for additional regulatory compliance information. To obtain product certifications and the DoC for NI

products, visit ni.com/certification, search by model number or product line, and click the appropriate link in the Certification column.

Environmental Management

NI is committed to designing and manufacturing products in an environmentally responsible manner. NI recognizes that eliminating certain hazardous substances from our products is beneficial to the environment and to NI customers.

For additional environmental information, refer to the **Minimize Our Environmental Impact** web page at ni.com/environment. This page contains the environmental regulations and directives with which NI complies, as well as other environmental information not included in this document.

Waste Electrical and Electronic Equipment (WEEE)

EU Customers At the end of the product life cycle, all NI products must be disposed of according to local laws and regulations. For more information about how to recycle NI products in your region, visit ni.com/environment/weee.

电子信息产品污染控制管理办法（中国 RoHS）

中国客户 National Instruments 符合中国电子信息产品中限制使用某些有害物质指令(RoHS)。关于 National Instruments 中国 RoHS 合规性信息，请登录 ni.com/environment/rohs_china。(For information about China RoHS compliance, go to ni.com/environment/rohs_china.)

¹ Channels support independent waveform generation.

² Amplitude values assume the full scale of the DAC is utilized. NI-FGEN uses waveforms less than the full scale of the DAC to create amplitudes smaller than the minimum value.

³ For example, a 5.5 V_{pk-pk} range equals ±2.75 V maximum offset. Offset range has a limitation of ±12 V absolute signal swing into high-impedance loads (**Amplitude** + |**Offset**| ≤ 12 V into high-impedance load or 6 V into 50 Ω load).

⁴ Terminated with high-impedance load (load impedance set to 1 MΩ). The analog path is calibrated for amplitude, gain, and offset errors.

⁵ Where **Amplitude Range** is the requested amplitude in V_{pk-pk}. For example, a DC signal with an amplitude range of 16 V_{pk-pk} and offset of 1.5 will calculate DC accuracy using the following equation: ±[(0.35% * 16 V) + (0.35% * 1.5 V) + 500 μV] = ±61.75 mV. The DC standard function always uses the 24 V_{pk-pk} amplitude range.

⁶ With 50 kHz sine wave and terminated with high-impedance load.

⁷ When the output path is disabled, the channel output is terminated to ground with a 50 Ω, 1 W resistor.

⁸ No damage occurs if the analog output channels are shorted to ground indefinitely.

⁹ The output terminals of multiple PXIe-5433 waveform generators can be connected together.

¹⁰ Normalized to 50 kHz.

¹¹ With sine frequencies 40 MHz or higher and ambient temperatures above 45 °C, add ±0.015 dB/°C to the passband flatness specification.

¹² At amplitude of -1 dBFS with 0 V DC offset, measured from DC to 400 MHz, and limited to a -90 dBm spur at low amplitudes.

¹³ Full-scale amplitude follows operation curve in [Figure 11](#).

¹⁴ At amplitude of -1 dBFS and measured from DC to the sixth harmonic.

¹⁵ Noise floor is limited by the noise floor of the measurement device.

16 At small amplitudes, average noise density is limited by a -154 dBm/Hz noise floor.

17 With 80 MHz carrier and locked to the internal timebase with spurs removed.

18 With 80 MHz carrier, integrated from 100 Hz to 100 kHz, and locked to the internal timebase.

19 Used for calculating duty cycle limit:

Minimum Duty Cycle = $(100\% * \text{Minimum On Time}) \div T_{\text{period}}$

and **Maximum Duty Cycle** = $100\% - \text{Minimum Duty Cycle}$. For more information about the relationship between minimum on/off time and duty cycle specifications, refer to ni.com.

20 Rise time measured from 10% to 90%.

21 Rise time will vary with amplitude due to operational amplifier slew rate saturation.

22 Integrated from 10 Hz to 10 MHz using a 27 MHz square wave.

23 At maximum user sample rate.

24 Relative to 50 kHz and at $2 V_{\text{pk-pk}}$ and maximum user sample rate.

25 With the digital filter enabled and at -1 dBFS, $2 V_{\text{pk-pk}}$, and 400 MS/s. Noise floor is limited by the noise floor of the measurement device.

26 With the digital filter enabled and at -7 dBFS, $2 V_{\text{pk-pk}}$, and 400 MS/s. Noise floor is limited by the noise floor of the measurement device.

27 If locked to an external Reference Clock source, timebase accuracy is equal to the external Reference Clock accuracy.

28 Where time drift starts at the latest external calibration date.

29 With a 20 MHz sine wave and both channels configured with the same amplitude.

30

NI-TClk synchronization support for the PXIe-5433 was first available in NI-FGEN 18.1. NI-TClk installs with NI-FGEN.

31 Specifications are valid for any number of PXIe-5433 modules installed in one chassis, with each PXIe-5433 module using a single NI-FGEN session and having all analog parameters set to identical values, and Sample Clock set to 100 MS/s. For other configurations, including multi-chassis systems, contact NI Technical Support at ni.com/support.

32 Manual adjustment is the process of minimizing synchronization jitter and skew by adjusting Trigger Clock (TClk) signals using the instrument driver.

33 Caused by clock and analog path delay differences.

34 Synchronization jitter is the variation in module alignment across calls to NI-TClk Synchronize.

35 In frequency list, arbitrary waveform, and arbitrary sequence output modes.

36 Warm up begins after the chassis is powered and the PXIe-5433 is recognized by the host and configured using NI-FGEN. Self-calibration is recommended following the warm-up time.