



PXLe-MIO5100 Bundle

Expandable PXI bundle based on PXLe-6345 MIO
DAQ, 80 AI Ch, 24 DIO Ch, 2 AO Ch

Specifications

PXLe-1083 and PXLe-6345

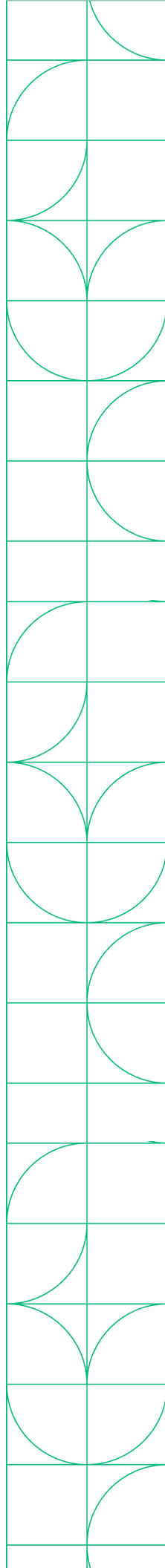

PXI MIO Bundle

In the Box

	PXIe-MIO5100 Bundle	Accessories:
PXIe-6345 (Multifunction IO)		<ul style="list-style-type: none">• SHC68-68-EPM Shielded Cable (x2)• SCB-68A Connector Block (x2)• Thunderbolt cable• Power cable (varied by PN)<ul style="list-style-type: none">○ 867123-01 (US)○ 867123-02 (EUR)○ 867123-03 (Generic)

Recommended Software

Test Workflow P/N: 788509-35	Test Workflow is a bundle of select NI software featuring engineering-specific tools that help test professionals accomplish anything from their day-to-day work to overcoming their most challenging obstacles.
	Test Workflow includes: <ul style="list-style-type: none">• LabVIEW - a graphical programming environment engineers use to develop automated research, validation, and production test systems.• InstrumentStudio - an application software that provides an integrated approach to interactive PXI measurements.• TestStand - a test executive software that accelerates system development and deployment for engineers in validation and production.• And more NI Software!

Table of Contents

This document combines the PDFs of this bundle together. The page numbers in the table of contents correspond to the page number of PDF the component's documentation begins.

PXIe-1083 Specifications.....	3
PXIe-6345 Specifications.....	16

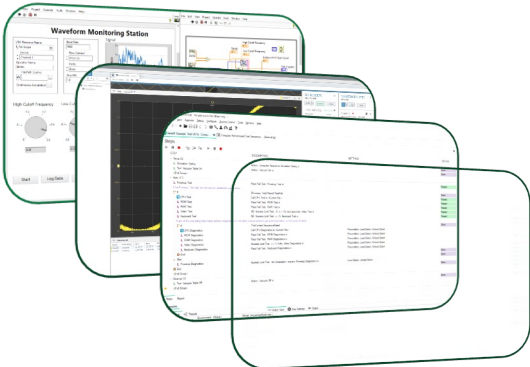

PXle-1083 Specifications



PXIe-1083 Specifications

This document contains specifications for the PXIe-1083 chassis.

Electrical

The following section provides information about the PXIe-1083 AC input and DC output.

AC Input

Input rating	100 VAC to 240 VAC, 50 Hz/60 Hz, 6 A to 3 A
Operating voltage range ¹	90 VAC to 264 VAC
Nominal input frequency	50 Hz/60 Hz
Operating frequency range ¹	47 Hz to 63 Hz
Efficiency	78% typical
Over-current protection	Internal fuse in line
Main power disconnect	The AC power cable provides main power disconnect. Do not position the equipment so that it is difficult to disconnect the power cord. The front-panel power switch causes the internal chassis power supply to provide DC power to the PXI Express backplane.



Caution Disconnect power cord to completely remove power.

DC Output

DC output characteristics of the PXIe-1083.

Voltage Rail	Maximum Current	Load Regulation	Maximum Ripple and Noise (20 MHz BW)
+5V_AUX	1.0 A	±5%	50 mVpp
+12 V	30.1 A	±5%	120 mVpp
+5 V	25.1 A	±5%	50 mVpp
+3.3 V	30.7 A	±5%	50 mVpp
-12 V	0.75 A	±5%	120 mVpp

Maximum total available power for the PXIe-1083 is 293 W.

The maximum combined power available on +3.3 V and +5 V is 180 W.

The maximum power available for each Thunderbolt port is 15 W (5 V/3 A).

Table 1. Backplane Slot Current Capacity

Slot	+5 V	V (I/O)	+3.3 V	+12 V	-12 V	5 V _{AUX}
Hybrid Peripheral Slot with PXI-5 Peripheral	-	-	3 A	6 A	-	1 A
Hybrid Peripheral Slot with PXI-1 Peripheral	6 A	5 A	6 A	1 A	1 A	-



Note PCI V(I/O) pins in Hybrid Peripheral Slots are connected to +5 V.



Note The maximum power dissipated in a peripheral slot should not exceed 58 W. Refer to the **Operating Environment** section for ambient temperature considerations at 58 W.

Over-current protection	All outputs are protected from short circuit and overload, they recover and return to regulation when the overload is removed and the power is cycled.
Over-voltage protection	+3.3 V clamped at 3.7 V to 4.3 V, +5 V clamped at 5.7 V to 6.5 V, +12 V clamped at 13.4 V to 15.6 V

Chassis Cooling

Module cooling	Forced air circulation (positive pressurization) through one 150 CFM fan
Module slot airflow direction	Bottom of module to top of module
Module intake	Bottom of chassis
Module exhaust	Top, right side of chassis
Slot cooling capacity	58 W; slot 6 supports 58 W cooling with high fan mode
Power supply cooling	Forced air circulation through integrated fans
Power supply intake	Front and left side chassis
Power supply exhaust	Rear of chassis
Minimum chassis cooling clearances	
Above	44.45 mm (1.75 in.)
Rear	44.45 mm (1.75 in.)
Sides	44.45 mm (1.75 in.)
Below	
Rack	44.45 mm (1.75 in.)
Desktop	25.4 mm (1.00 in.)

Environmental

Maximum altitude	2,000 m (6,560 ft.), 800 mbar (at 25 °C ambient, high fan mode)
Pollution Degree	2

Indoor use only.

Operating Environment

Ambient temperature range	
When all peripheral modules require ≤ 38 W cooling capacity per slot	0 °C to 50 °C (IEC 60068-2-1 and IEC 60068-2-2.) ² Meets MIL-PRF-28800F Class 3 low temperature limit and high temperature limit.
When any peripheral module requires > 38 W cooling capacity per slot	0 °C to 40 °C (IEC 60068-2-1 and IEC 60068-2-2.) ² Meets MIL-PRF-28800F Class 3 low temperature limit and MIL-PRF-28800F Class 4 high temperature limit.
Relative humidity range	20% to 80%, noncondensing

Storage Environment

Ambient temperature range	-40 °C to 71 °C (IEC-60068-2-1 and IEC-60068-2-2.) ^[3] Meets MIL-PRF-28800F Class 3 limits.
Relative humidity range	10% to 95%, noncondensing

Shock and Vibration

Operational shock	30 g peak, half-sine, 11 ms pulse (IEC-60068-2-27.) ³ Meets MIL-PRF-28800F Class 2 limits.
Operational random vibration	5 to 500 Hz, 0.3 g _{rms}
Non-operating vibration	5 to 500 Hz, 2.4 g _{rms} (IEC 60068-2-64.) ³ Non-operating test profile exceeds the requirements of MIL-PRF-28800F, Class 3.

Acoustic Emissions

Sound Pressure Level (at Operator Position)

(Tested in accordance with ISO 7779. Meets MIL-PRF-28800F requirements.)

38 W Profile

Auto fan (up to 30 °C ambient)	33.7 dBA
High fan	50.8 dBA

58 W Profile

Auto fan (up to 30 °C ambient)	54.7 dBA
High fan	55.3 dBA

Sound Power Level

38 W Profile

Auto fan (up to 30 °C ambient)	44.9 dBA
High fan	60.3 dBA

58 W Profile

Auto fan (up to 30 °C ambient)	63.4 dBA
High fan	64.2 dBA



Note The protection provided by the PXIe-1083 can be impaired if it is used in a manner not described in this document.

Safety Compliance Standards

This product is designed to meet the requirements of the following electrical equipment safety standards for measurement, control, and laboratory use:

- IEC 61010-1, EN 61010-1
- UL 61010-1, CSA C22.2 No. 61010-1



Note For safety certifications, refer to the product label or the [Product Certifications and Declarations](#) section.

EMC Guidelines

This product was tested and complies with the regulatory requirements and limits for electromagnetic compatibility (EMC) stated in the product specifications. These requirements and limits provide reasonable protection against harmful interference when the product is operated in the intended operational electromagnetic environment.

This product is intended for use in industrial locations. However, harmful interference may occur in some installations, when the product is connected to a peripheral device or test object, or if the product is used in residential areas. To minimize interference with radio and television reception and prevent unacceptable performance degradation, install and use this product in strict accordance with the instructions in the product documentation.

Furthermore, any changes or modifications to the product not expressly approved by NI could void your authority to operate it under your local regulatory rules.

EMC Notices

Refer to the following notices for cables, accessories, and prevention measures necessary to ensure the specified EMC performance.



Notice

For EMC declarations and certifications, and additional information, refer to the [Product Certifications and Declarations](#) section.



Notice Changes or modifications to the product not expressly approved by NI could void your authority to operate the product under your local regulatory rules.



Notice Operate this product only with shielded cables and accessories.

Electromagnetic Compatibility Standards

This product meets the requirements of the following EMC standards for electrical equipment for measurement, control, and laboratory use:

- EN 61326-1 (IEC 61326-1): Class A emissions; Basic immunity
- EN 55011 (CISPR 11): Group 1, Class A emissions

- AS/NZS CISPR 11: Group 1, Class A emissions



Note Group 1 equipment (per CISPR 11) is any industrial, scientific, or medical equipment that does not intentionally generate radio frequency energy for the treatment of material or inspection/analysis purposes.



Note In Europe, Canada, Australia, and New Zealand (per CISPR 11) Class A equipment is intended for use in nonresidential locations.

CE Compliance

This product meets the essential requirements of applicable European Directives, as follows:

- 2014/35/EU; Low-Voltage Directive (safety)
- 2014/30/EU; Electromagnetic Compatibility Directive (EMC)
- 2011/65/EU; Restriction of Hazardous Substances (RoHS)

Product Certifications and Declarations

Refer to the product Declaration of Conformity (DoC) for additional regulatory compliance information. To obtain product certifications and the DoC for NI products, visit ni.com/product-certifications, search by model number, and click the appropriate link.

Environmental Management

NI is committed to designing and manufacturing products in an environmentally responsible manner. NI recognizes that eliminating certain hazardous substances from our products is beneficial to the environment and to NI customers.

For additional environmental information, refer to the **Engineering a Healthy Planet** web page at ni.com/environment. This page contains the environmental

regulations and directives with which NI complies, as well as other environmental information not included in this document.

EU and UK Customers

-  Waste Electrical and Electronic Equipment (WEEE)—At the end of the product life cycle, all NI products must be disposed of according to local laws and regulations. For more information about how to recycle NI products in your region, visit ni.com/environment/weee.

电子信息产品污染控制管理办法 (中国 RoHS)

-  中国 RoHS— NI 符合中国电子信息产品中限制使用某些有害物质指令(RoHS)。关于 NI 中国 RoHS 合规性信息，请登录 ni.com/environment/rohs_china。(For information about China RoHS compliance, go to ni.com/environment/rohs_china.)

Backplane

Size	3U-sized; 5 peripheral slots. Compliant with IEEE 1101.10 mechanical packaging. PXI Express Specification compliant. Accepts both PXI Express and CompactPCI (PICMG 2.0 R 3.0) 3U modules.
Backplane bare-board material	UL 94 V-0 Recognized
Backplane connectors	Conforms to IEC 917 and IEC 1076-4-101, UL 94 V-0 rated

System Synchronization Clocks

10 MHz System Reference Clock: PXI_CLK10

Maximum slot-to-slot skew	250 ps
Accuracy	± 25 ppm max (guaranteed over the operating temperature range)
Maximum jitter	5 ps RMS phase-jitter (10 Hz–1 MHz range)
Duty-factor	45% to 55%
Unloaded signal swing	3.3 V \pm 0.3 V



Note For other specifications, refer to the **PXI-1 Hardware Specification**.

100 MHz System Reference Clock: PXIe_CLK100 and PXIe_SYNC100

Maximum slot-to-slot skew	100 ps
Accuracy	± 25 ppm max (guaranteed over the operating temperature range)
Maximum jitter	3 ps RMS phase-jitter (10 Hz to 12 kHz range), 2 ps RMS phase-jitter (12 kHz to 20 MHz range)
Duty-factor for PXIe_CLK100	45% to 55%
Absolute differential voltage (When terminated with a 50 Ω load to 1.30 V or Thévenin equivalent)	400 mV to 1000 mV



Note For other specifications, refer to the **PXI-5 PXI Express Hardware Specification**.

Mechanical

Standard chassis dimensions	
Height	177.1 mm (6.97 in.)
Width	257.1 mm (10.12 in.)
Depth	214.2 mm (8.43 in.)
Weight	6.7 kg (14.8 lb)
Chassis materials	Extruded Aluminum (6063-T5, 6060-T6), Cold Rolled Steel/Stainless Steel, Santoprene, Urethane Foam, PC-ABS, Nylon, Polyethylene
Finish	Conductive Clear Iridite on Aluminum, Electroplated Nickel on Cold Rolled Steel, Electroplated Zinc on Cold Rolled Steel

The following figures show the PXIe-1083 chassis dimensions. The holes shown are for installing the optional rack mount kits.

Figure 1. PXIe-1083 Chassis Dimensions (Front)

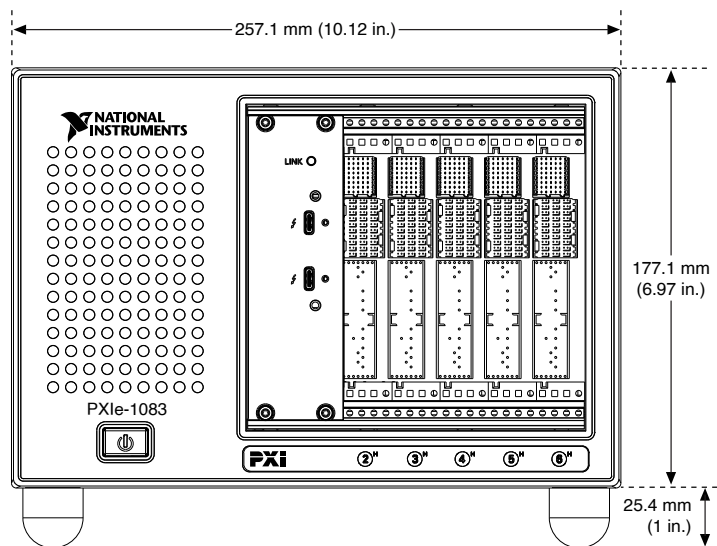

Figure 2. PXIe-1083 Chassis Dimensions (Side)

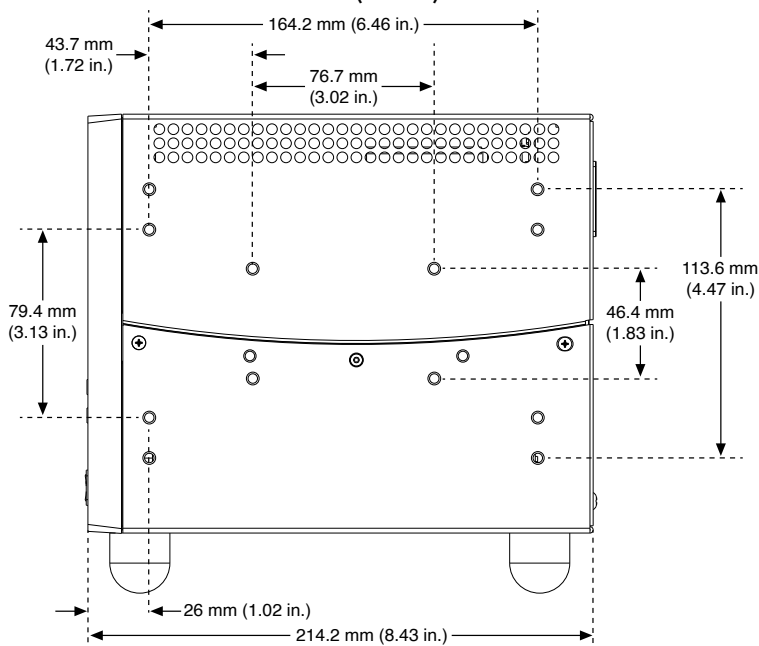
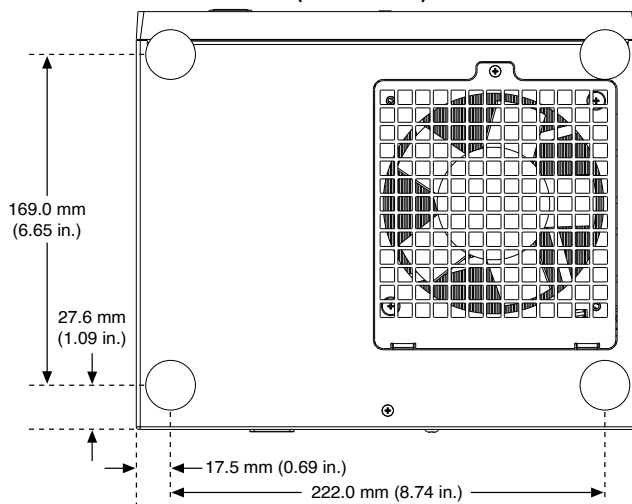

Figure 3. PXIe-1083 Chassis Dimensions (Bottom)



¹ The operating range is guaranteed by design.

² This product meets the requirements of the environmental standards for electrical equipment for measurement, control, and laboratory use.

³ This product meets the requirements of the environmental standards for electrical equipment for measurement, control, and laboratory use.

PXle-6345 Specifications



Introduction

Français	Deutsch	日本語	한국어	简体中文
ni.com/manuals				

The following specifications are typical at 25 °C, unless otherwise noted. For more information about the NI 6345, refer to the **X Series User Manual** available at ni.com/manuals.

Analog Input

Number of channels	40 differential or 80 single-ended
ADC resolution	16 bits
DNL	No missing codes guaranteed
INL	Refer to the AI Absolute Accuracy section.
Sample rate	
Single channel maximum	500 kS/s
Multichannel maximum	500 kS/s
Minimum	No minimum
Timing resolution	10 ns
Timing accuracy	50 ppm of sample rate
Input coupling	DC

Input range	± 0.1 V, ± 0.2 V, ± 0.5 V, ± 1 V, ± 2 V, ± 5 V, ± 10 V
Maximum working voltage for analog inputs (signal + common mode)	± 11 V of AI GND
CMRR (DC to 60 Hz)	100 dB

Figure 1. CMRR

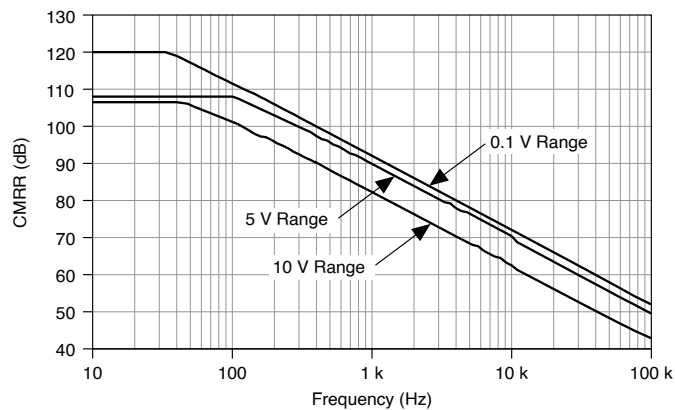

Input impedance

Device on

AI+ to AI GND >10 G Ω in parallel with 100 pF

AI- to AI GND >10 G Ω in parallel with 100 pF

Device off

AI+ to AI GND 820 Ω

AI- to AI GND 820 Ω

Input bias current	± 100 pA
--------------------	--------------

Crosstalk (at 100 kHz)

Adjacent channels	-75 dB
Non-adjacent channels	-88 dB
Small signal bandwidth (-3 dB)	1.7 MHz
Input FIFO size	4,095 samples
Scan list memory	4,095 entries
Data transfers	DMA (scatter-gather), programmed I/O
Overvoltage protection for all analog input and sense channels	
Device on	± 25 V for up to two AI pins
Device off	± 15 V for up to two AI pins
Input current during overvoltage condition	± 20 mA max/AI pin

Settling Time for Multichannel Measurements

Range	± 60 ppm of Step (± 4 LSB for Full-Scale Step)	± 15 ppm of Step (± 1 LSB for Full-Scale Step)
± 10 V, ± 5 V, ± 2 V, ± 1 V	2 μ s	2 μ s
± 0.5 V	2 μ s	2 μ s
± 0.2 V, ± 0.1 V	2 μ s	8 μ s

Figure 2. Settling Time versus Time for Different Source Impedances

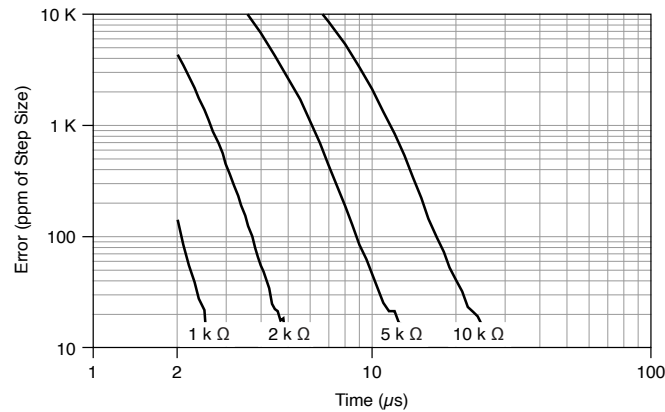

AI Absolute Accuracy

Nominal Range Positive Full Scale	Nominal Range Negative Full Scale	Residual Gain Error (ppm of Reading)	Residual Offset Error (ppm of Range)	Offset Tempco (ppm of Range/°C)	Random Noise, σ (μVrms)	Absolute Accuracy at Full Scale ^[1] (μV)
10	-10	48	13	21	281	1520
5	-5	55	13	21	137	800
2	-2	55	13	24	56	320
1	-1	65	17	27	35	180
0.5	-0.5	68	17	34	26	95
0.2	-0.2	95	27	55	21	50
0.1	-0.1	108	45	90	16	32

Table 1. AI Absolute Accuracy

Gain tempco	13 ppm/°C
Reference tempco	1 ppm/°C
INL error	46 ppm of range

Note Accuracies listed are valid for up to two years from the device external calibration.

AI Absolute Accuracy Equation

AbsoluteAccuracy = Reading · (GainError) + Range · (OffsetError) + NoiseUncertainty

- GainError = ResidualGainError + GainTempco · (TempChangeFromLastInternalCal) + ReferenceTempco · (TempChangeFromLastExternalCal)
- OffsetError = ResidualOffsetError + OffsetTempco · (TempChangeFromLastInternalCal) + INLError
- NoiseUncertainty = $\frac{\text{Random Noise}}{\sqrt{10,000}} \cdot 3$ for a coverage factor of 3σ and averaging 10,000 points.

AI Absolute Accuracy Example

Absolute accuracy at full scale on the analog input channels is determined using the following assumptions:

- TempChangeFromLastExternalCal = 10 °C
- TempChangeFromLastInternalCal = 1 °C
- number_of_readings = 10,000
- CoverageFactor = 3σ

For example, on the 10 V range, the absolute accuracy at full scale is as follows:

- GainError = 48 ppm + 13 ppm · 1 + 1 ppm · 10 = 71 ppm
- OffsetError = 13 ppm + 21 ppm · 1 + 46 ppm = 80 ppm
- NoiseUncertainty = $\frac{281 \mu\text{V}}{\sqrt{10,000}} \cdot 3 = 8.4 \mu\text{V}$
- AbsoluteAccuracy = 10 V · (GainError) + 10 V · (OffsetError) + NoiseUncertainty = 1,520 μV

Analog Triggers

Number of triggers	1	
Source	AI <0..79>	
Functions	Start Trigger, Reference Trigger, Pause Trigger, Sample Clock, Convert Clock, Sample Clock Timebase	
Source level		
AI <0..79>	±Full scale	
APFI 0	±10 V	
Resolution	16 bits	
Modes	Analog edge triggering, analog edge triggering with hysteresis, and analog window triggering	
Bandwidth (-3 dB)		
AI <0..79>	3.4 MHz	
APFI 0	3.9 MHz	
Accuracy	±1% of range	
APFI 0 characteristics		
Input impedance	10 kΩ	
Coupling	DC	

Protection, power on	± 30 V
Protection, power off	± 15 V

Analog Output

Number of channels	2
DAC resolution	16 bits
DNL	± 1 LSB
Monotonicity	16-bit guaranteed
Maximum update rate	
1 channel	2.86 MS/s
2 channels	2.00 MS/s
Timing accuracy	50 ppm of sample rate
Timing resolution	10 ns
Output range	± 10 V, ± 5 V, \pm external reference on APFI 0
Output coupling	DC
Output impedance	0.2 Ω
Output current drive	± 5 mA

Overdrive protection	± 25 V
Overdrive current	26 mA
Power-on state	± 5 mV
Power-on/off glitch	1.5 V peak for 200 ms
Output FIFO size	8,191 samples shared among channels used
Data transfers	DMA (scatter-gather), programmed I/O
AO waveform modes	Non-periodic waveform, periodic waveform regeneration mode from onboard FIFO, periodic waveform regeneration from host buffer including dynamic update
Settling time, full-scale step, 15 ppm (1 LSB)	2 μ s
Slew rate	20 V/ μ s
Glitch energy at midscale transition, ± 10 V range	10 nV \cdot s

External Reference

APFI 0 characteristics	
Input impedance	10 k Ω
Coupling	DC
Protection, device on	± 30 V

Protection, device off	± 15 V
Range	± 11 V
Slew rate	20 V/ μ s

Figure 3. AO External Reference Bandwidth

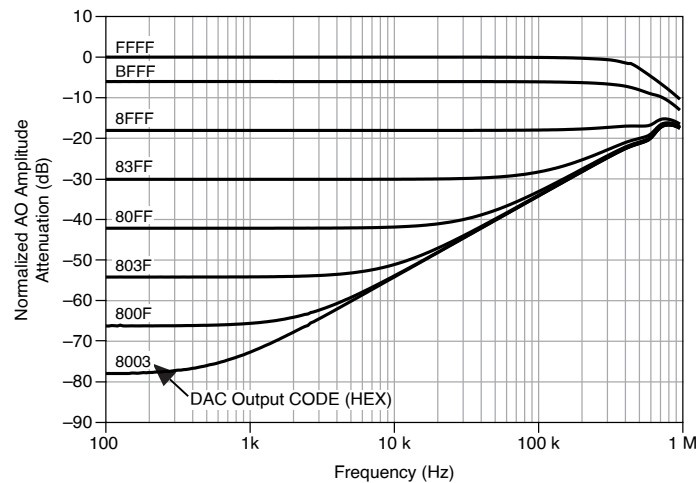

AO Absolute Accuracy

Absolute accuracy at full-scale numbers is valid immediately following self calibration and assumes the device is operating within 10 °C of the last external calibration.

Nominal Range Positive Full Scale	Nominal Range Negative Full Scale	Residual Gain Error (ppm of Reading)	Gain Tempco (ppm/°C)	Absolute Accuracy at Full Scale (μ V)
10	-10	63	17	1890
5	-5	70	8	935

Table 2. AO Absolute Accuracy

Reference tempco (ppm/°C)	1
---------------------------	---

Residual offset error (ppm of range)	33
Offset tempco (ppm of range/°C)	2
INL Error (ppm of range)	64

Note Accuracies listed are valid for up to two years from the device external calibration.

AO Absolute Accuracy Equation

- $AbsoluteAccuracy = OutputValue \cdot (GainError) + Range \cdot (OffsetError)$
- $GainError = ResidualGainError + GainTempco \cdot (TempChangeFromLastInternalCal) + ReferenceTempco \cdot (TempChangeFromLastExternalCal)$
- $OffsetError = ResidualOffsetError + OffsetTempco \cdot (TempChangeFromLastInternalCal) + INLError$

Digital I/O/PFI

Static Characteristics

Number of channels	24 total, 8 (P0.<0..7>), 16 (PFI <0..7>/P1, PFI <8..15>/P2)
Ground reference	D GND
Direction control	Each terminal individually programmable as input or output
Pull-down resistor	50 kΩ typical, 20 kΩ minimum
Input voltage protection	±20 V on up to two pins

Caution Stresses beyond those listed under the **Input voltage protection** specification may cause permanent damage to the device.

Input FIFO size	255 samples
Output FIFO size	2,047 samples
Resolution	32 bits

Waveform Characteristics (Port 0 Only)

Terminals used	Port 0 (P0.<0..7>)
Port/sample size	Up to 8 bits
Waveform generation (DO) FIFO	2,047 samples
Waveform acquisition (DI) FIFO	255 samples
DI Sample Clock frequency	0 to 10 MHz, system and bus activity dependent
DO Sample Clock frequency	0 to 10 MHz, system and bus activity dependent
Data transfers	DMA (scatter-gather), programmed I/O
Digital line filter settings	160 ns, 10.24 μ s, 5.12 ms, disable

PFI/Port 1/Port 2 Functionality

Functionality	Static digital input, static digital output, timing input, timing output
---------------	--

Timing output sources	Many AI, AO, counter, DI, DO timing signals
Debounce filter settings	90 ns, 5.12 μ s, 2.56 ms, custom interval, disable; programmable high and low transitions; selectable per input

Recommended Operation Conditions

Input high voltage (V_{IH})	
Minimum	2.2 V
Maximum	5.25 V
Input low voltage (V_{IL})	
Minimum	0 V
Maximum	0.8 V
Output high current (I_{OH})	
P0.<0..7>	-24 mA maximum
PFI <0..15>/P1/P2	-16 mA maximum
Output low current (I_{OL})	
P0.<0..7>	24 mA maximum
PFI <0..15>/P1/P2	16 mA maximum

Digital I/O Characteristics

Positive-going threshold (VT+)	2.2 V maximum
Negative-going threshold (VT-)	0.8 V minimum
Delta VT hysteresis (VT+ - VT-)	0.2 V minimum
I _{IL} input low current (V _{IN} = 0 V)	-10 μ A maximum
I _{IH} input high current (V _{IN} = 5 V)	250 μ A maximum

Figure 4. P0.<0..7>: I_{OH} versus V_{OH}

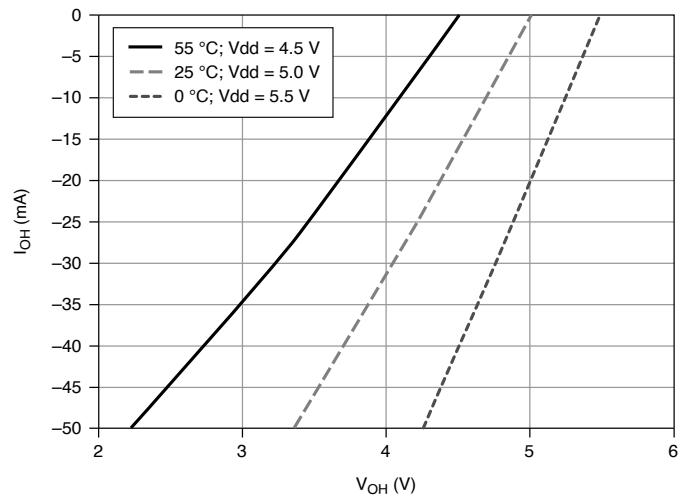

Figure 5. P0.<0..7>: I_{OL} versus V_{OL}

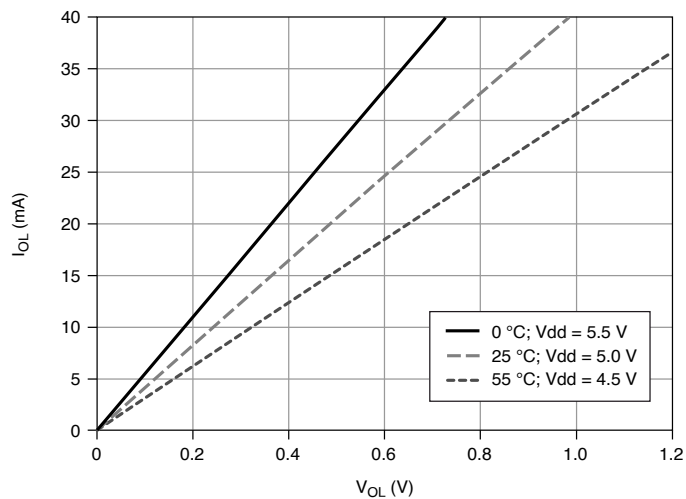

Figure 6. PFI <0..15>/P1/P2: I_{OH} versus V_{OH}

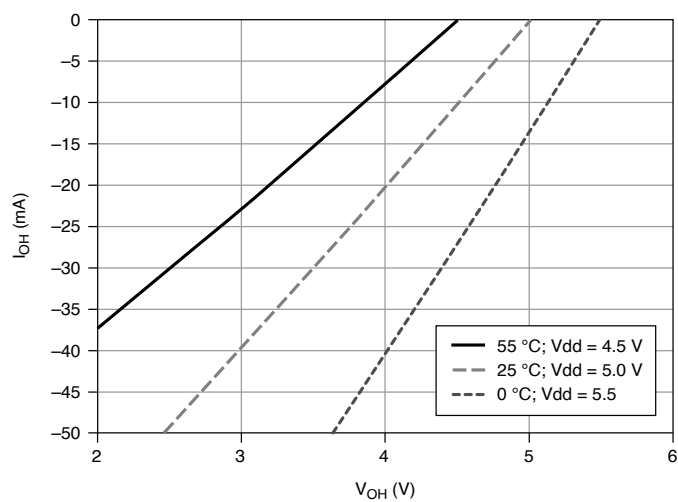
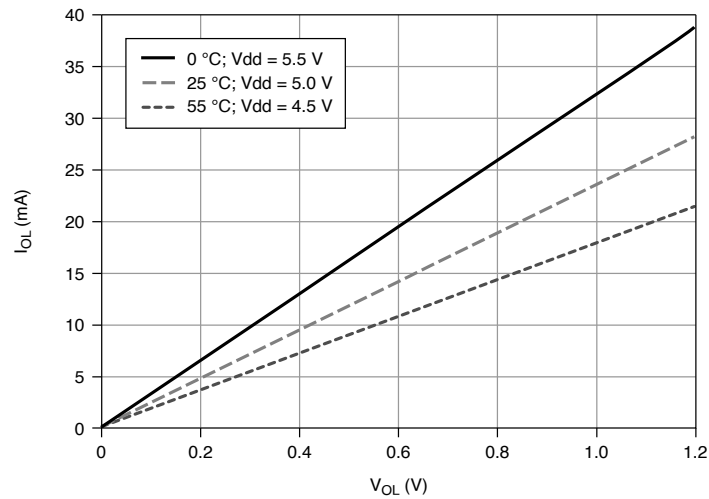

Figure 7. PFI <0..15>/P1/P2: I_{OL} versus V_{OL} 

General-Purpose Counters

Number of counter/timers	4
Resolution	32 bits
Counter measurements	Edge counting, pulse, pulse width, semi-period, period, two-edge separation
Position measurements	X1, X2, X4 quadrature encoding with Channel Z reloading; two-pulse encoding
Output applications	Pulse, pulse train with dynamic updates, frequency division, equivalent time sampling
Internal base clocks	100 MHz, 20 MHz, 100 kHz
External base clock frequency	0 MHz to 25 MHz; 0 MHz to 100 MHz on PXIe_DSTAR <A,B>
Base clock accuracy	50 ppm

Inputs	Gate, Source, HW_Arm, Aux, A, B, Z, Up_Down, Sample Clock
Routing options for inputs	Any PFI, PXIe_DSTAR<A,B>, PXI_TRIG, PXI_STAR, analog trigger, many internal signals
FIFO	127 samples per counter
Data transfers	Dedicated scatter-gather DMA controller for each counter/timer, programmed I/O

Frequency Generator

Number of channels	1
Base clocks	20 MHz, 10 MHz, 100 kHz
Divisors	1 to 16
Base clock accuracy	50 ppm

Phase-Locked Loop (PLL)

Number of PLLs	1
Reference Signal	PXI Express Locking Input Frequency (MHz)
PXIe_DSTAR<A,B>	10, 20, 100
PXI_STAR	10, 20
PXIe_CLK100	100
PXI_TRIG <0..7>	10, 20
PFI <0..15>	10, 20

Table 3. Reference Clock Locking Frequencies

Output of PLL	100 MHz Timebase; other signals derived from 100 MHz Timebase including 20 MHz and 100 kHz Timebases.
---------------	---

External Digital Triggers

Source	Any PFI, PXIe_DSTAR<A,B>, PXI_TRIG, PXI_STAR
Polarity	Software-selectable for most signals
Analog input function	Start Trigger, Reference Trigger, Pause Trigger, Sample Clock, Convert Clock, Sample Clock Timebase
Analog output function	Start Trigger, Pause Trigger, Sample Clock, Sample Clock Timebase
Counter/timer functions	Gate, Source, HW_Arm, Aux, A, B, Z, Up_Down, Sample Clock
Digital waveform generation (DO) function	Start Trigger, Pause Trigger, Sample Clock, Sample Clock Timebase
Digital waveform acquisition (DI) function	Start Trigger, Reference Trigger, Pause Trigger, Sample Clock, Sample Clock Timebase

Device-to-Device Trigger Bus

Input source	PXI_TRIG <0..7>, PXI_STAR, PXIe_DSTAR<A,B>
Output destination	PXI_TRIG <0..7>, PXIe_DSTARC
Output selections	10 MHz Clock, frequency generator output, many internal signals
Debounce filter settings	90 ns, 5.12 μ s, 2.56 ms, custom interval, disable; programmable high and low transitions; selectable per input

Bus Interface

Form factor	x1 PXI Express peripheral module, specification rev. 1.0 compliant
Slot compatibility	x1 and x4 PXI Express or PXI Express hybrid slots
DMA channels	8, analog input, analog output, digital input, digital output, counter/timer 0, counter/timer 1, counter/timer 2, counter/timer 3

Devices may be installed in PXI Express slots or PXI Express hybrid slots.

Power Requirements

Caution The protection provided by the device can be impaired if the device is used in a manner not described in the **X Series User Manual**.

+3.3 V	1.6 W
+12 V	19.8 W

Current Limits

+5 V terminal (connector 0)	1 A max
P0/PFI/P1/P2 and +5 V terminals combined	1.5 A max

Physical Characteristics

Device dimensions	Standard 3U PXI
-------------------	-----------------

Weight	198 g (7.0 oz)
I/O connectors	2 68-pin VHDCI

Caution If you need to clean the module, wipe it with a dry towel.

Calibration (AI and AO)

Recommended warm-up time	15 minutes
Calibration interval	2 years

Maximum Working Voltage

Maximum working voltage refers to the signal voltage plus the common-mode voltage.

Channel to earth	11 V, Measurement Category I
------------------	------------------------------

Measurement Category I is for measurements performed on circuits not directly connected to the electrical distribution system referred to as MAINS voltage. MAINS is a hazardous live electrical supply system that powers equipment. This category is for measurements of voltages from specially protected secondary circuits. Such voltage measurements include signal levels, special equipment, limited-energy parts of equipment, circuits powered by regulated low-voltage sources, and electronics.

Caution Do not use for measurements within Categories II, III, or IV.

Note Measurement Categories CAT I and CAT O (Other) are equivalent. These test and measurement circuits are not intended for direct

connection to the MAINS building installations of Measurement Categories CAT II, CAT III, or CAT IV.

Shock and Vibration

Operational shock	30 g peak, half-sine, 11 ms pulse (Tested in accordance with IEC-60068-2-27. Test profile developed in accordance with MIL-PRF-28800F.)
Random vibration	
Operating	5 to 500 Hz, 0.3 grms
Nonoperating 5 to 500 Hz, 2.4 grms (Tested in accordance with IEC-60068-2-64. Nonoperating test profile exceeds the requirements of MIL-PRF-28800F, Class 3.)	

Environmental

Operating temperature	0 to 55 °C
Storage temperature	-40 to 70 °C
Operating humidity	10 to 90% RH, noncondensing
Storage humidity	5 to 95% RH, noncondensing
Pollution degree	2
Maximum altitude	2,000 m

Indoor use only.

Safety

This product meets the requirements of the following standards of safety for electrical equipment for measurement, control, and laboratory use:

- IEC 61010-1, EN 61010-1
- UL 61010-1, CSA 61010-1

Note For UL and other safety certifications, refer to the product label or the [Online Product Certification](#) section.

Electromagnetic Compatibility

This product meets the requirements of the following EMC standards for electrical equipment for measurement, control, and laboratory use:

- EN 61326-1 (IEC 61326-1): Class B emissions; Basic immunity
- EN 55011 (CISPR 11): Group 1, Class B emissions
- EN 55022 (CISPR 22): Class B emissions
- EN 55024 (CISPR 24): Immunity
- AS/NZS CISPR 11: Group 1, Class B emissions
- AS/NZS CISPR 22: Class B emissions
- FCC 47 CFR Part 15B: Class B emissions
- ICES-001: Class B emissions

Note In the United States (per FCC 47 CFR), Class A equipment is intended for use in commercial, light-industrial, and heavy-industrial locations. In Europe, Canada, Australia and New Zealand (per CISPR 11) Class A equipment is intended for use only in heavy-industrial locations.

Note Group 1 equipment (per CISPR 11) is any industrial, scientific, or medical equipment that does not intentionally generate radio frequency energy for the treatment of material or inspection/analysis purposes.

Note For EMC declarations and certifications, and additional information, refer to the **Online Product Certification** section.

CE Compliance

This product meets the essential requirements of applicable European Directives, as follows:

- 2006/95/EC; Low-Voltage Directive (safety)
- 2004/108/EC; Electromagnetic Compatibility Directive (EMC)

Online Product Certification

Refer to the product Declaration of Conformity (DoC) for additional regulatory compliance information. To obtain product certifications and the DoC for this product, visit ni.com/certification, search by model number or product line, and click the appropriate link in the Certification column.

Environmental Management

NI is committed to designing and manufacturing products in an environmentally responsible manner. NI recognizes that eliminating certain hazardous substances from our products is beneficial to the environment and to NI customers.

For additional environmental information, refer to the **Minimize Our Environmental Impact** web page at ni.com/environment. This page contains the environmental regulations and directives with which NI complies, as well as other environmental information not included in this document.

Waste Electrical and Electronic Equipment (WEEE)

EU Customers At the end of the product life cycle, all NI products must be disposed of according to local laws and regulations. For more information about how to recycle NI products in your region, visit ni.com/environment/weee.

电子信息产品污染控制管理办法（中国 RoHS）

中国客户 National Instruments 符合中国电子信息产品中限制使用某些有害物质指令(RoHS)。关于 National Instruments 中国 RoHS 合规性信息，请登录 ni.com/environment/rohs_china。(For information about China RoHS compliance, go to ni.com/environment/rohs_china.)

Device Pinout

Figure 8. NI PXIe-6345 Pinout

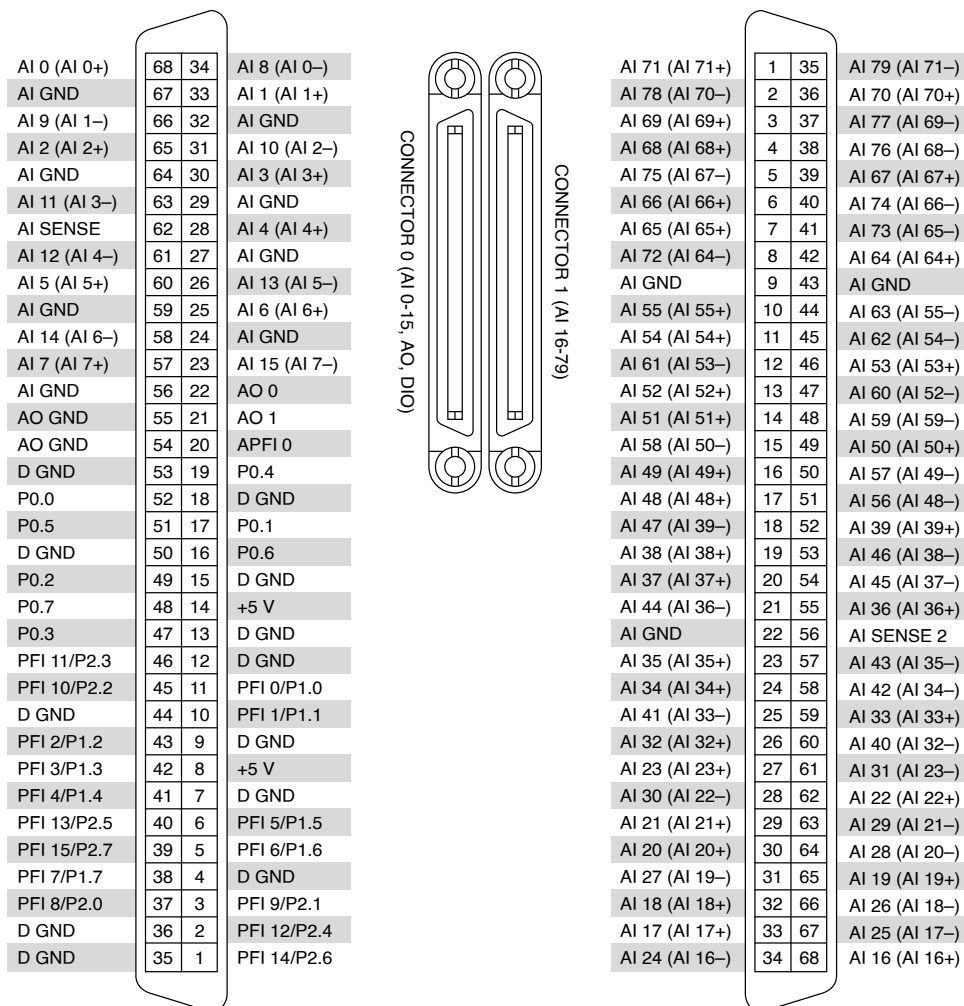

¹ Refer to the **AI Absolute Accuracy Example** section.