



## RX 8141

### ERGO™ Flush Precision Cut Diagonal Cutter with Oval Head 0.1-1.25 mm







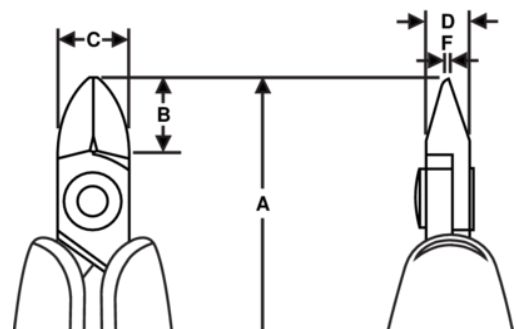



#### PRODUCT DETAILS

- Precision oval head diagonal cutters developed according to the scientific ERGO™ process, Oval head
- ERGO™ handles with two-component combination, thermoplastic surface, for comfortable grip, on tough polypropylene core for rigidity
- Micro-bevel, flush & ultra-cut
- The cutting capacity that is given is for copper wire
- Cutting capacity: 0.1 mm-0.8 mm to 0.4 mm-2 mm
- High performance alloyed steel
- Burnished finish
- Numerically controlled machine grinding guarantees edge angle accuracy & contact, increases the tool's reliability & consistency
- Precision induction-hardened edges 63-65 HRC
- Screw joint minimises friction & maximises alignment of cutting edges
- ESD safe handles in two-component synthetic material
- Bio spring limits the tension throughout the working cycle of the tool & can be adjusted to 3 different positions or removed
- Ideal for wire harness work & standard printed circuit board assembly



PRODUCT ATTRIBUTES

Product: **RX 8141**

	Oval		S		Flush
	0.1-1.25 mm		0.00-0.05 in		0.2-0.5 mm
	0.01-0.02 in	<b>A</b>	135.5 mm	<b>A</b>	5.33 in
<b>B</b>	10,5 mm	<b>B</b>	0,41 in	<b>C</b>	10 mm
<b>C</b>	0.39 in	<b>D</b>	6 mm	<b>D</b>	0,24 inch
<b>F</b>	0,8 mm	<b>F</b>	0,03 in		70 g
<b>Ω</b>	Dissipative				