



RX 8162

**ERGO™ Ultra-Flush® Precision
Cut Diagonal Cutter with Oval
Head 0.3-1.6 mm**







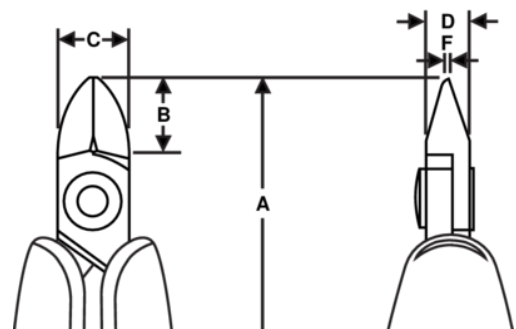



PRODUCT DETAILS

- Precision oval head diagonal cutters developed according to the scientific ERGO™ process, Oval head
- ERGO™ handles with two-component combination, thermoplastic surface, for comfortable grip, on tough polypropylene core for rigidity
- Micro-bevel, flush & ultra-cut
- The cutting capacity that is given is for copper wire
- Cutting capacity: 0.1 mm-0.8 mm to 0.4 mm-2 mm
- High performance alloyed steel
- Burnished finish
- Numerically controlled machine grinding guarantees edge angle accuracy & contact, increases the tool's reliability & consistency
- Precision induction-hardened edges 63-65 HRC
- Screw joint minimises friction & maximises alignment of cutting edges
- ESD safe handles in two-component synthetic material
- Bio spring limits the tension throughout the working cycle of the tool & can be adjusted to 3 different positions or removed
- Ideal for wire harness work & standard printed circuit board assembly



PRODUCT ATTRIBUTES

Product: **RX 8162**

	Oval		L		Ultra-Flush®
	0.3-1.6 mm		0.01 - 0.06 in		
		A	147 mm	A	5.80 in
B	16 mm	B	0,63 in	C	16 mm
C	0.63 in	D	8 mm	D	0,31 inch
F	1,6 mm	F	0,06 in		97 g
Ω	Dissipative				